

FLOS

■ F3170030 Black

IC Lights T1 High

Designed by Michael Anastassiades, 2014



Halogen - 60W

Table lamp providing diffused light. Frame in brass, brushed and transparent varnished or chrome steel, and black. Blown glass opal diffuser. Dimmer on the power chord.

Are you a professional and your project needs consulting and support?

[BOOK AN APPOINTMENT](#)

Main specifications

EAN	8059607002636
Mounting	Table
Environments	Indoor dry location
Light Source Type	Bulb
Lamp category	Halogen
Lamp holders	E14
Iicos	HSGS
Number of heads	1
Power (W)	60

Physical

Colour	Black
Length (mm)	200
Net weight (kg)	1.4
Package height (mm)	0
Package width (mm)	0
Package length (mm)	0
Package volume (m3)	0.04
IP internal	20

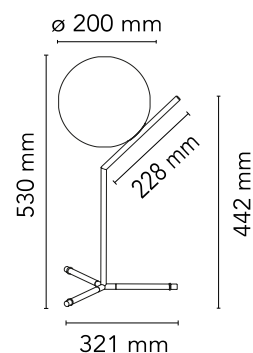

Download

[Mounting instructions](#) PDF

[Spare Parts](#) PDF

Photometric Files

[LDT / IES](#) LDT

Technical Drawings

[2D](#) ZIP

[3D](#) ZIP

[Bim](#) ZIP



Schematic light drawing

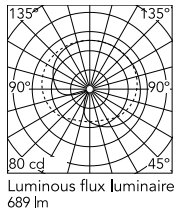

Photometric

Lighting type	Total
Light distribution	Asymmetric

Electrical

Insulation class	II
Frequency (Hz)	50/60
Main voltage (Vac)	220-240
LED voltage Vf (Vdc)	null
Dimmable	Yes
Dimming interface	Dimmer Integrated
Plug type	Type C
Batteries inside	No

Bulbs

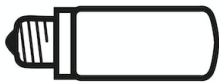

NOT INCLUDED

RF32290

LED Lamp E14 8W 2700K T28

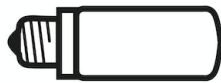

NOT INCLUDED

RF32291

LED Lamp E14 8W 3000K T28

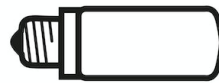

NOT INCLUDED

RF32767

LED Lamp 9W E14 220-240V
2700K T28

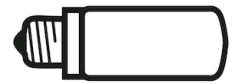

NOT INCLUDED

RF32768

LED Lamp 9W E14 220-240V
3000K T28

Spare Parts

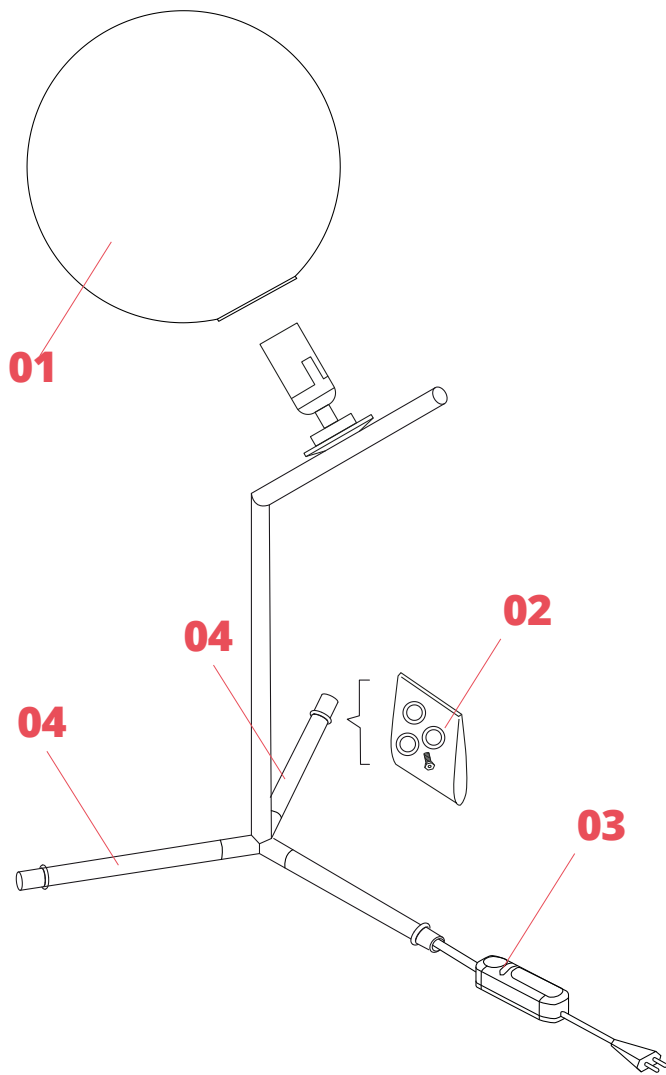

- | | | |
|-----|-------------------------------------|-----------|
| 02. | Gasket and foot kit for ic high-low | RF3160400 |
| 03. | Dimmer 4-25W 220-240V Black | RF32262 |
| 04. | Lower black leg | RF27823 |

DOWNLOAD



RF3160400

Gasket and foot kit for ic high-low

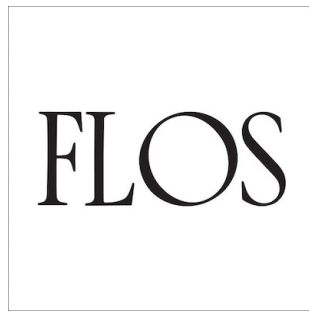

RF32262

Dimmer 4-25W 220-240V Black



RF27823

Lower black leg