

# New System



New lighting atmospheres

Cattaneo, forte dei suoi cinquant'anni di storia nel mondo dell'illuminazione, si racconta attraverso un rinnovato approccio comunicativo e una collezione di prodotti capaci non solo di illuminare gli ambienti, ma di generare nuove atmosfere.

Non una trasformazione, ma un'evoluzione basata sulla consapevolezza dei propri caratteri di unicità: valori autentici, che dall'azienda familiare, sono maturati in una realtà aziendale d'avanguardia, che desidera dare la propria personalissima risposta al presente evidenziando una predisposizione tecnologica al futuro.

La passione artigianale e la ricerca tecnologica generano corpi illuminanti che sono il connubio di dettagli perfetti. Ogni lampada è frutto di un processo creativo che fonde progettazione e ricerca generando oggetti di forte impatto estetico, capaci di rispondere alle esigenze funzionali e relazionarsi con l'utilizzatore dal punto di vista empatico e sensoriale.

Il concetto di made in Italy, oltre ad offrire cura artigianale e innovazione tecnologica, evolve in life style: i prodotti Cattaneo diventano strumento indispensabile nella progettazione degli spazi e promettono di emozionare attraverso il design della luce.

Cattaneo, mit fünfzig vierzigjährigen Geschichte in der Welt der Beleuchtung, erzählt seine Geschichte durch einen erneuerten kommunikativen Ansatz und eine Sammlung von Produkten, die nicht nur die Räume beleuchten, sondern auch neue Atmosphären erzeugen können.

Keine Transformation, sondern eine Evolution, die auf dem Bewusstsein der eigenen Eigenschaften der Einzigartigkeit basiert: authentische Werte, die aus dem Familienunternehmen stammen, sind zu einer avantgardistischen Geschäftsrealität gereift, die der Gegenwart ihre ganz persönliche Antwort geben will und eine technologische Prädisposition für die Zukunft aufzeigt.

Die Leidenschaft für Handwerk und technologische Forschung erzeugt Leuchten, die die Kombination perfekter Details sind. Jede Lampe ist das Ergebnis eines kreativen Prozesses, der Design und Forschung verbindet, Objekte mit starker ästhetischer Wirkung erzeugt, in der Lage ist, auf funktionale Bedürfnisse zu reagieren und sich aus einfühlsamer und sensorischer Sicht mit dem Benutzer zu befassen.

Das Konzept von Made in Italy entwickelt sich neben handwerklichem Können und technologischer Innovation auch zum Lifestyle: Cattaneo-Produkte werden zu einem unverzichtbaren Werkzeug bei der Gestaltung von Räumen und versprechen, durch die Gestaltung von Licht zu begeistern.

Cattaneo, with its fifty years' experience in the lighting business, describes itself by means of a renovated communicative approach and a collection of products able to lighten spaces as well as giving birth to new atmospheres.

Not a transformation, but an evolution based on the awareness of its own peculiarities: genuine values that from a family business have grown wiser into a leading edge business institution, willing to give its own and personal answer to the present, outlining a real technological talent for future.

Artisan passion and technological research give birth to light fittings that represent the union of perfect details. Each light is the result of a creative process that blends design and research, creating objects with a strong aesthetic effect, able to respond to functional requirements and to relate themselves with the end user from an emphatic and sensory point of view.

The concept of Made in Italy does not simply mean artisan care and technological innovation, but evolves into "life style": Cattaneo products become the essential instrument to design spaces; their shaping of the light vows to get people emotional.



**Lucilla System**  
p 5



**Lucilla Terra**  
p 27



**Lucilla Suspension**  
p 37



**Lucilla Parete Plafone**  
p 43



**Rays**  
p 53



**Vintage**  
p 61



**Mickey**  
p 65

# Lucilla System

design by C. Cattaneo

Sistema personalizzabile. Grazie alla sua struttura il sistema Lucilla System ti permette di raggiungere luoghi d'illuminazione lontani dal tuo punto luce creando piacevoli installazioni.

System that can be customised. Thanks to its peculiar structure, Lucilla System makes it possible to bring light away from light sources, creating nice installations.

Flexibles System Hängelampen, das einfach an persönliche Bedürfnisse angepasst werden kann. Die Struktur des Lucilla System bietet die Möglichkeit, das Licht weit weg vom Stromverteiler zu tragen und faszinierende Installationsformen zu kreieren.

# Esempi d'installazione personalizzata

Examples of customised installation - Beispiele für kundenspezifische Installationen

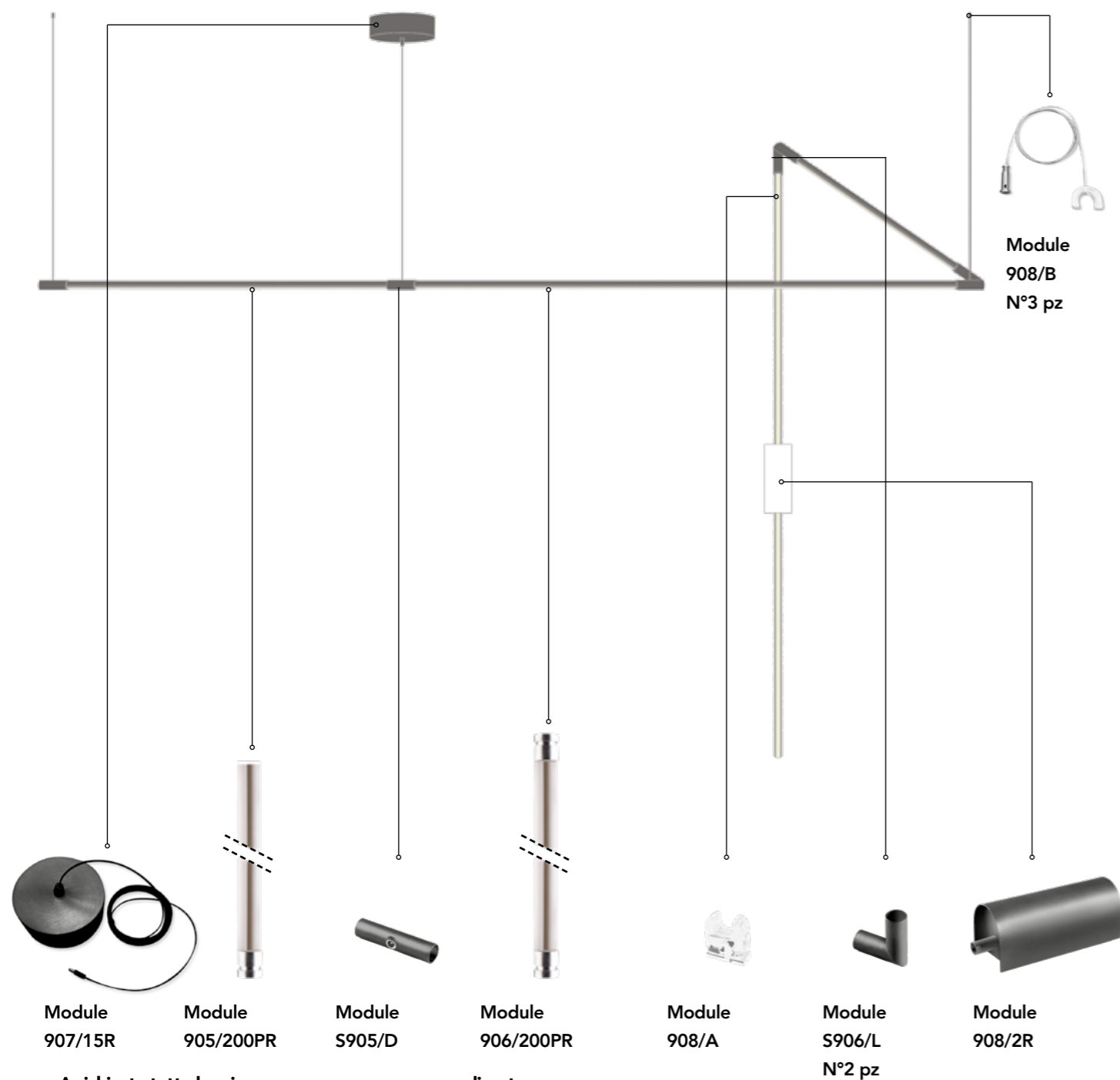

A richiesta tutte le misure possono essere personalizzate.  
 On demand all sizes can be customised.  
 Alle Größen können auf Anfrage personalisiert werden.

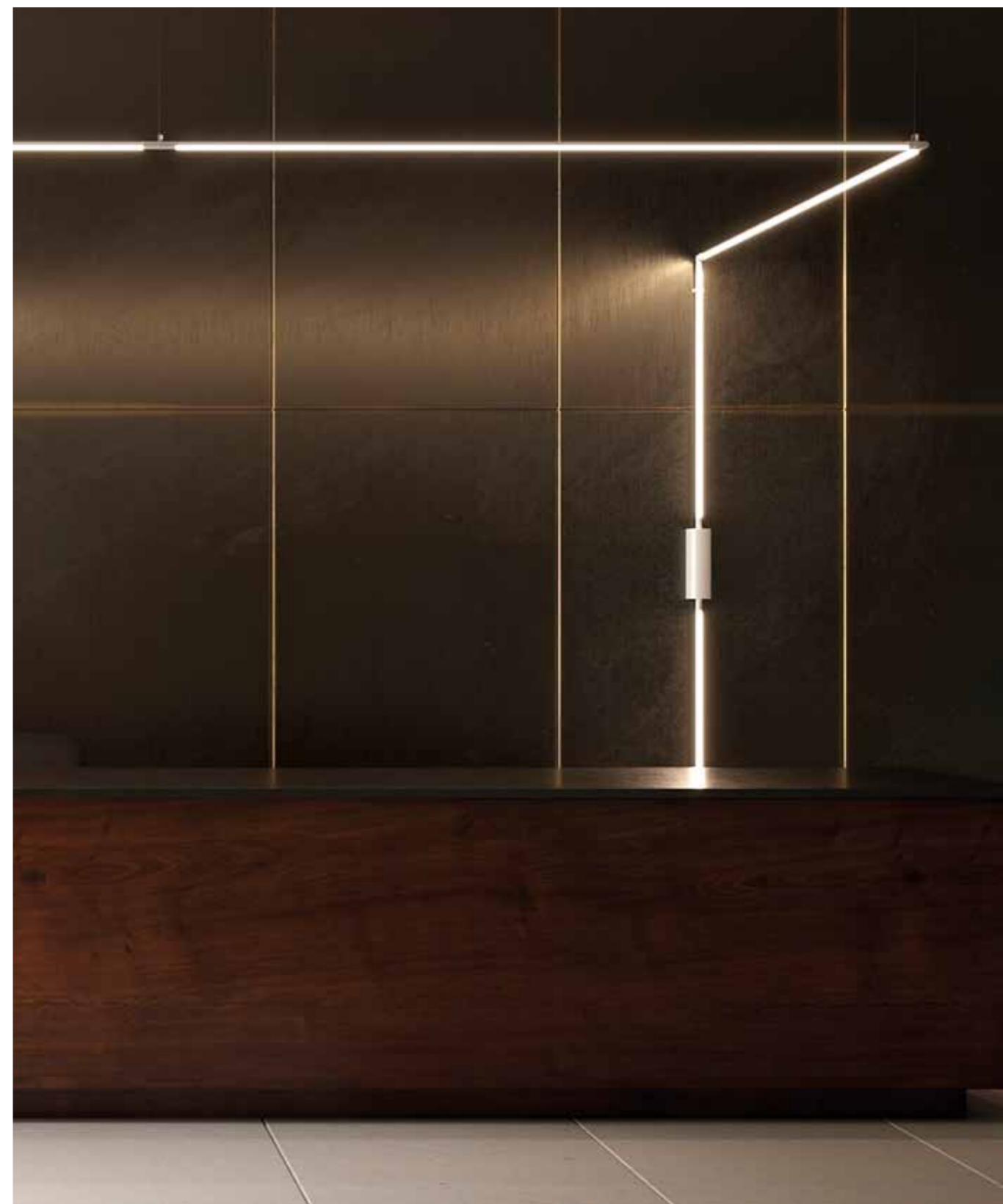
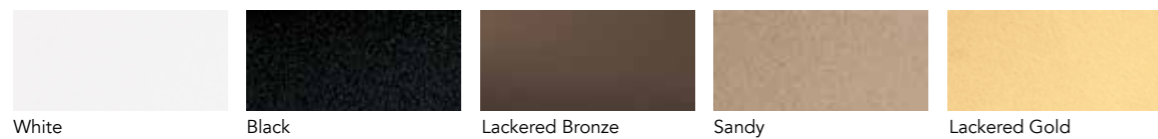

# Esempi d'installazione personalizzata

Examples of customised installation - Beispiele für kundenspezifische Installationen

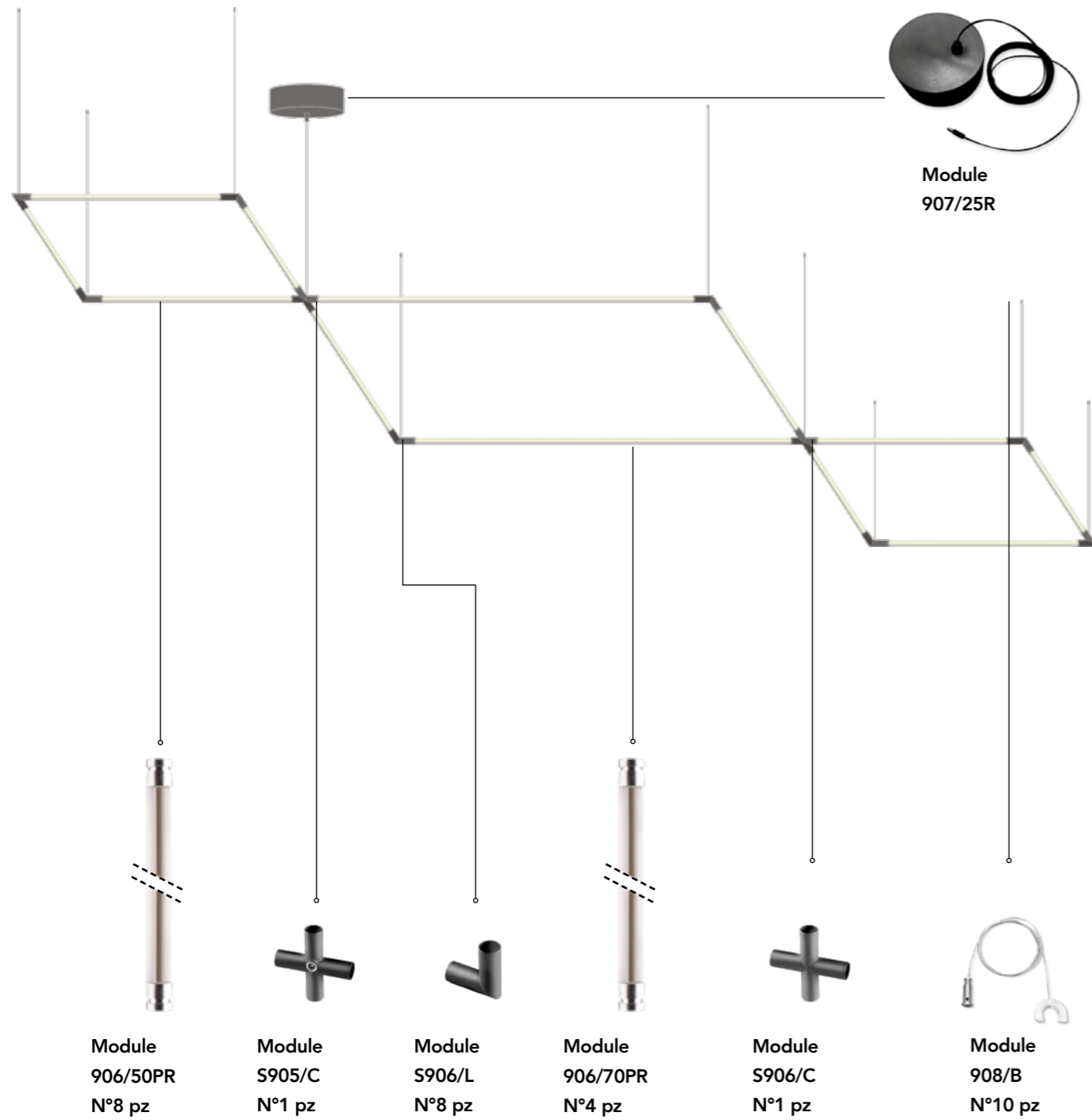

A richiesta tutte le misure possono essere personalizzate.  
 On demand all sizes can be customised.  
 Alle Größen können auf Anfrage personalisiert werden.

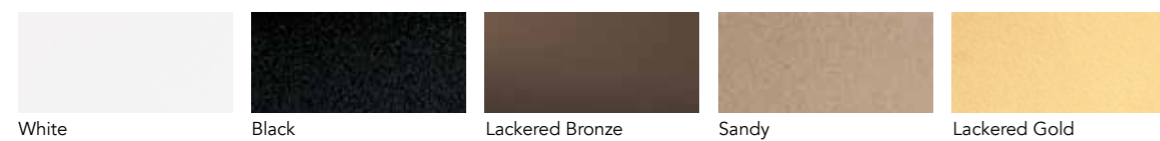

Lucilla System

# Esempi d'installazione personalizzata

Examples of customised installation - Beispiele für kundenspezifische Installationen

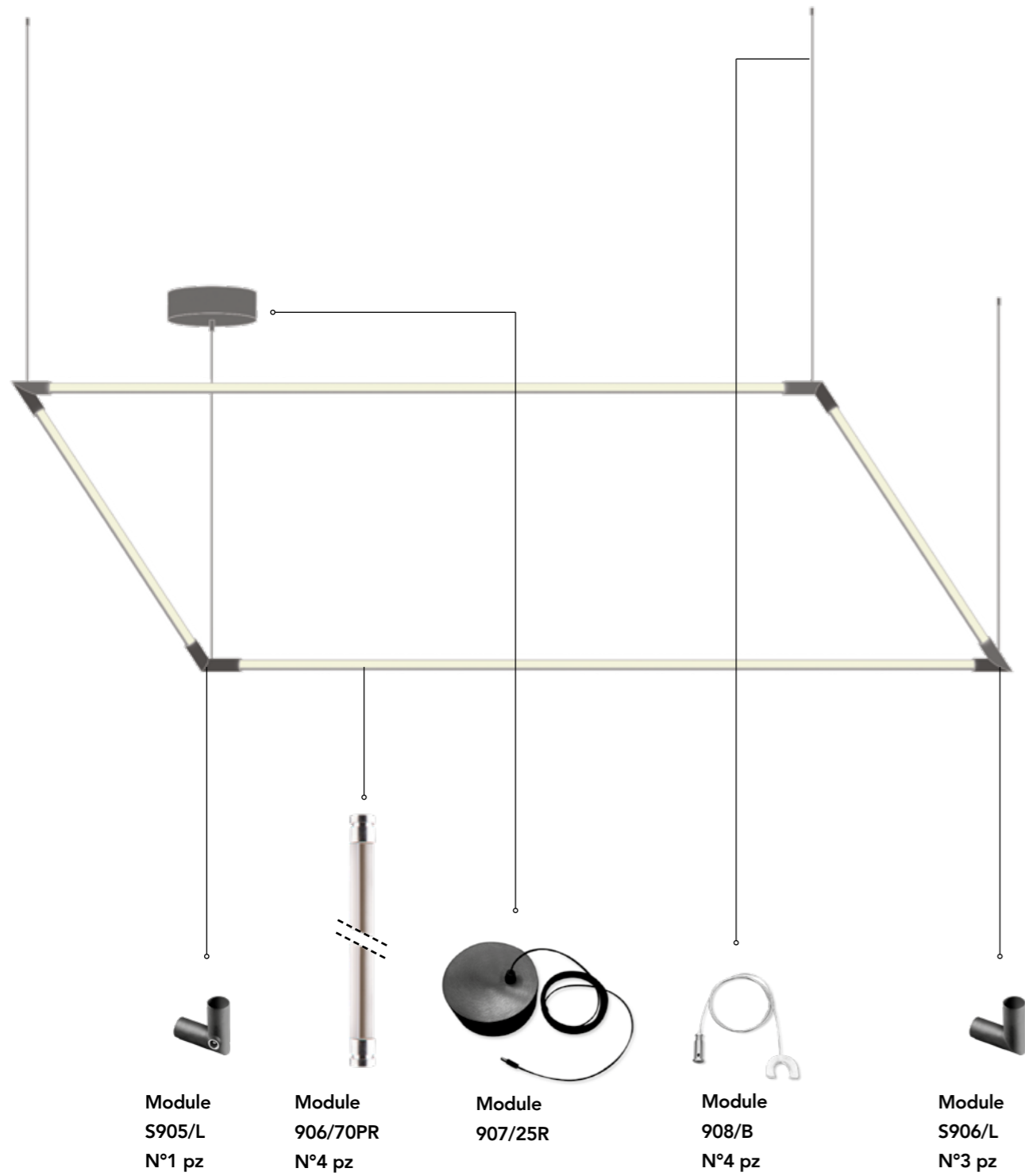

A richiesta tutte le misure possono essere personalizzate.  
 On demand all sizes can be customised.  
 Alle Größen können auf Anfrage personalisiert werden.

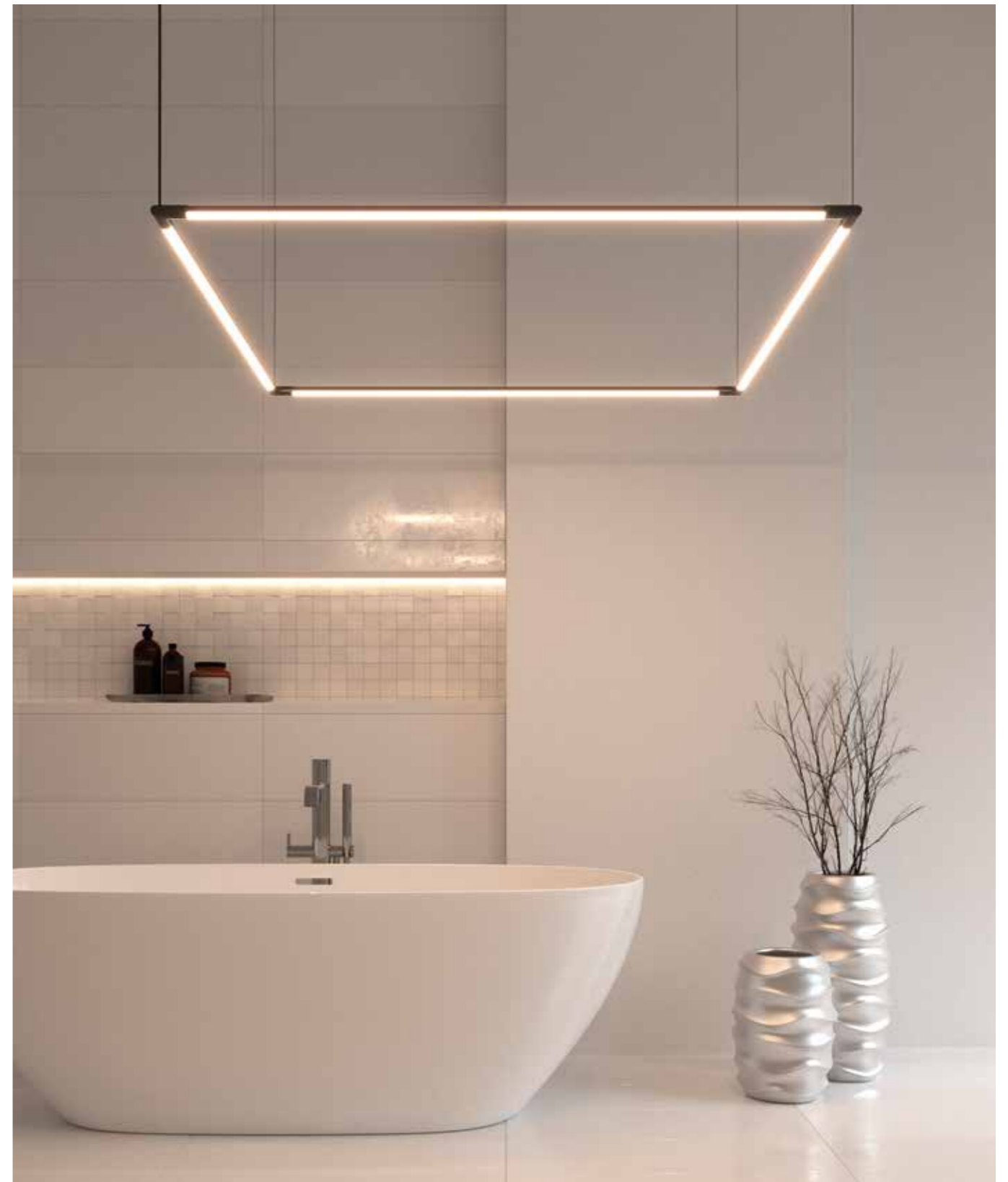
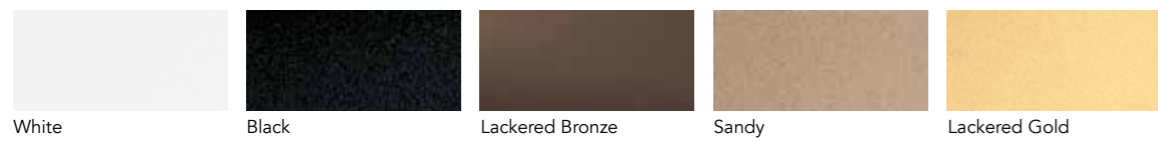

# Moduli

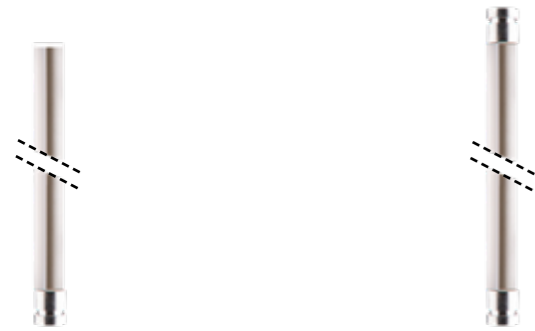

- Module**  
**905/20PR** LED 3,92W 24V 400lm  
**905/30PR** LED 5,88W 24V 600lm  
**905/40PR** LED 7,84W 24V 800lm  
**905/50PR** LED 9,8W 24V 1000lm  
**905/60PR** LED 11,76W 24V 1200lm  
**905/70PR** LED 13,72W 24V 1400lm  
**905/80PR** LED 15,68W 24V 1600lm  
**905/90PR** LED 17,64W 24V 1800lm  
**905/100PR** LED 19,6W 24V 2000lm  
**905/110PR** LED 21,56W 24V 2200lm  
**905/120PR** LED 23,52W 24V 2400lm  
**905/130PR** LED 25,48W 24V 2600lm  
**905/140PR** LED 27,44W 24V 2800lm  
**905/150PR** LED 29,4W 24V 3000lm  
**905/160PR** LED 31,36W 24V 3200lm  
**905/170PR** LED 33,32W 24V 3400lm  
**905/180PR** LED 35,28W 24V 3600lm  
**905/190PR** LED 37,24W 24V 3800lm  
**905/200PR** LED 39,2W 24V 4000lm

- Module**  
**906/20PR** LED 3,92W 24V 400lm  
**906/30PR** LED 5,88W 24V 600lm  
**906/40PR** LED 7,84W 24V 800lm  
**906/50PR** LED 9,8W 24V 1000lm  
**906/60PR** LED 11,76W 24V 1200lm  
**906/70PR** LED 13,72W 24V 1400lm  
**906/80PR** LED 15,68W 24V 1600lm  
**906/90PR** LED 17,64W 24V 1800lm  
**906/100PR** LED 19,6W 24V 2000lm  
**906/110PR** LED 21,56W 24V 2200lm  
**906/120PR** LED 23,52W 24V 2400lm  
**906/130PR** LED 25,48W 24V 2600lm  
**906/140PR** LED 27,44W 24V 2800lm  
**906/150PR** LED 29,4W 24V 3000lm  
**906/160PR** LED 31,36W 24V 3200lm  
**906/170PR** LED 33,32W 24V 3400lm  
**906/180PR** LED 35,28W 24V 3600lm  
**906/190PR** LED 37,24W 24V 3800lm  
**906/200PR** LED 39,2W 24V 4000lm

3000°K upon request 2700/4000°K



Montaggio facile con innesto jack che consente una rapida installazione.  
 Grazie alla sua versatilità si può ruotare e creare scenari con luce diretta e/o indiretta.

Easy mounting with a jack plug that allows for quick installation.  
 Thanks to its versatility, it can be tilted, rotated and create scenarios with direct and/or indirect light.

Einfache Montage mit einem Jack-Stecker, der eine schnelle Installation ermöglicht.  
 Dank ihrer Vielseitigkeit kann sie gekippt und gedreht werden und Szenarien mit direktem und/oder indirektem Licht schaffen.

## Moduli senza ingresso alimentazione - Module without Stromeingang - Module ohne Stromeingang



## Moduli con ingresso alimentazione - Module mit Stromeingang - Module mit Stromeingang

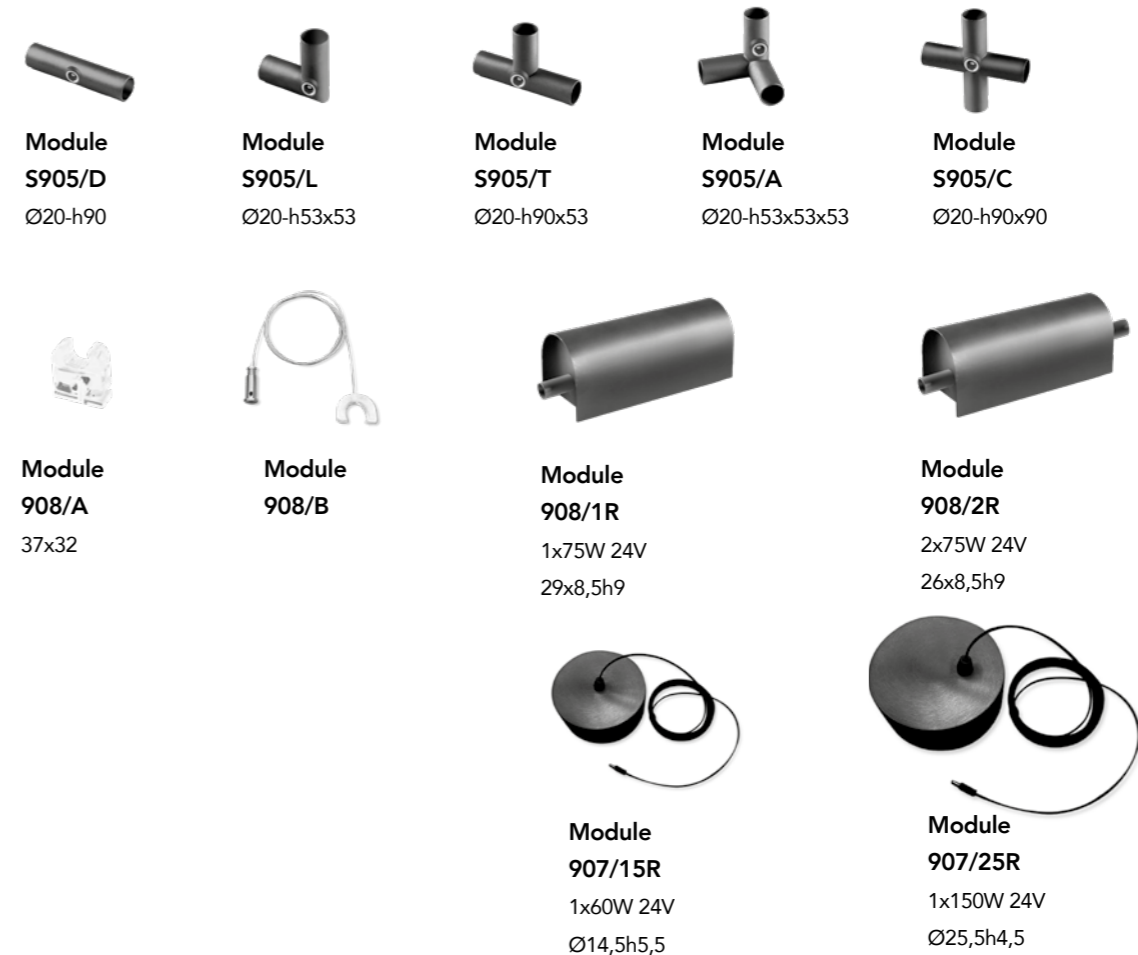

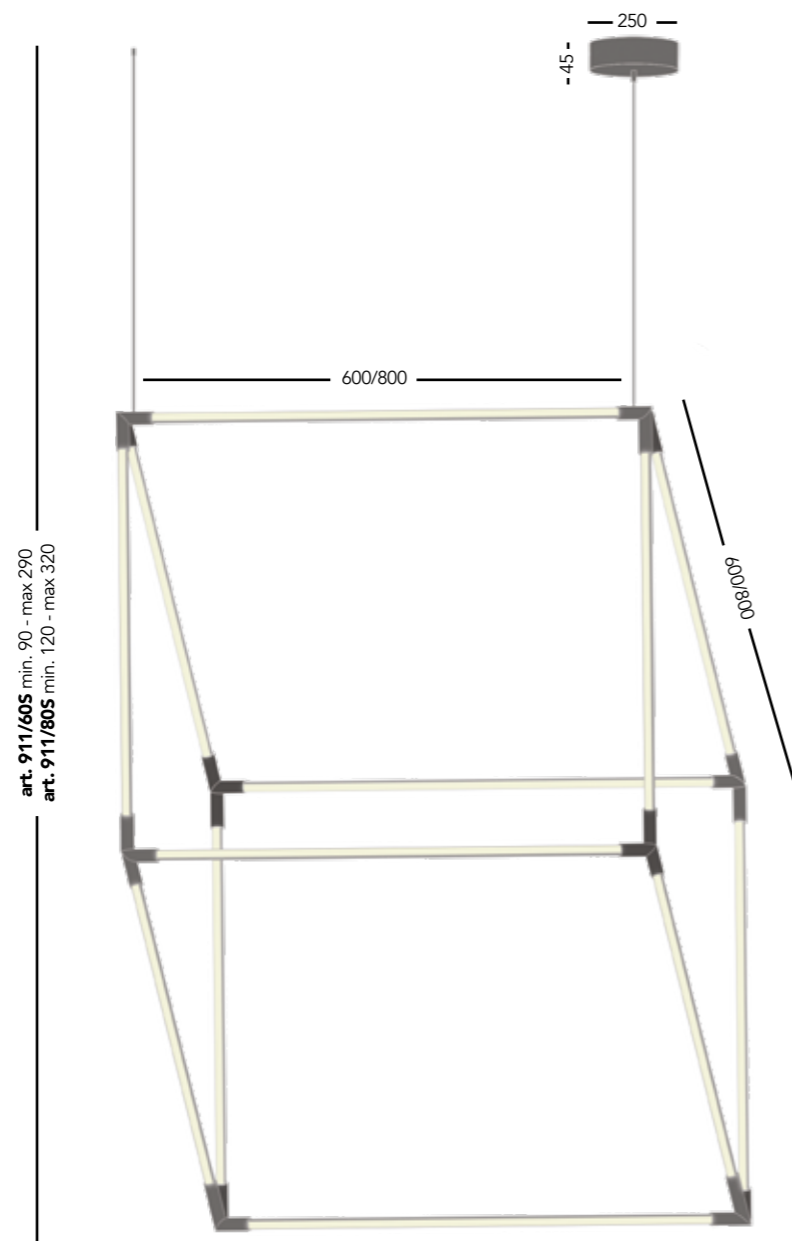

**911/605**

LED 141,12W 24V  
14400lm - 3000°K  
upon request 2700/4000°K

CE IP20  
Dimmable PUSH

**911/805**

LED 188,16W 24V  
19200lm - 3000°K  
upon request 2700/4000°K

CE IP20  
Dimmable PUSH

**A richiesta tutte le misure possono essere personalizzate.  
On demand all sizes can be customised.  
Alle Größen können auf Anfrage personalisiert werden.**

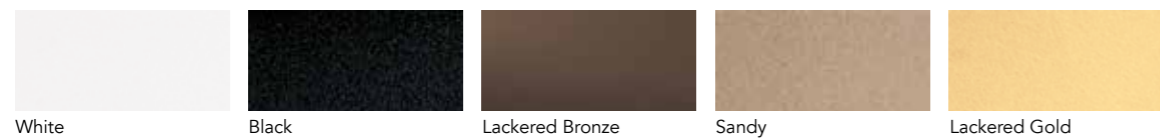

White

Black

Lackered Bronze

Sandy

Lackered Gold

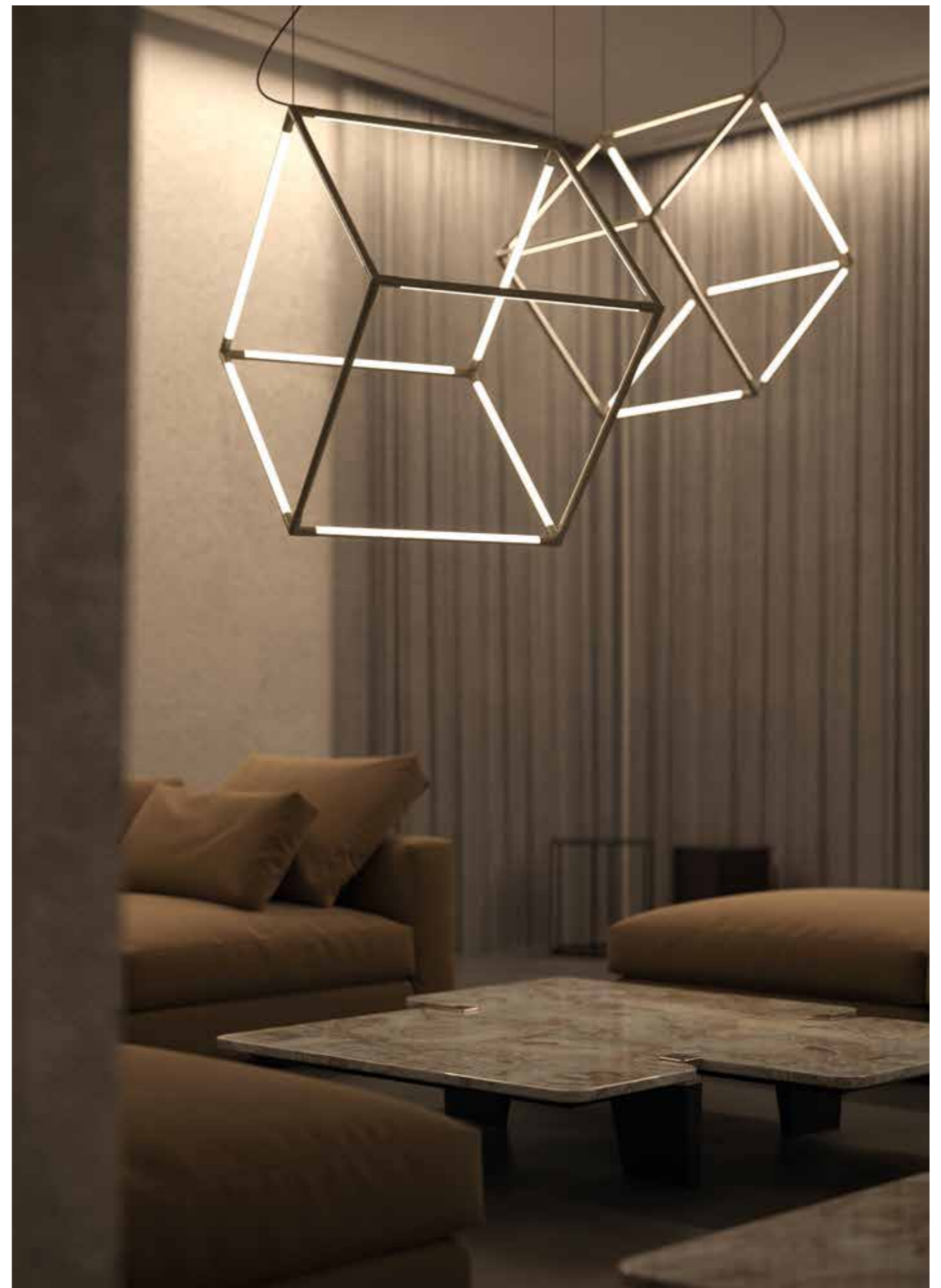





Lucilla System

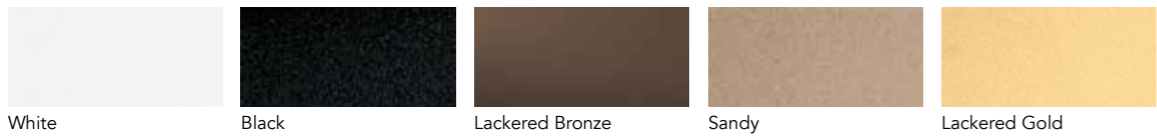



**910/1S**  
 LED 43,120W 24V  
 4400lm - 3000°K  
 upon request  
 2700/4000°K  
 CE IP20  
 Dimmable PUSH

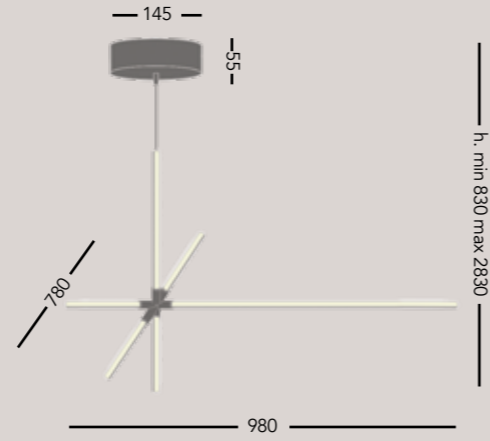

**910/2S**  
 LED 52,92W 24V  
 5400lm - 3000°K  
 upon request  
 2700/4000°K  
 CE IP20  
 Dimmable PUSH

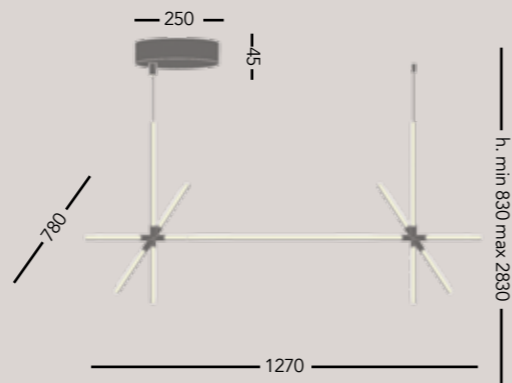

**910/3S**  
 LED 94W 24V  
 9600lm - 3000°K  
 upon request  
 2700/4000°K  
 CE IP20  
 Dimmable PUSH

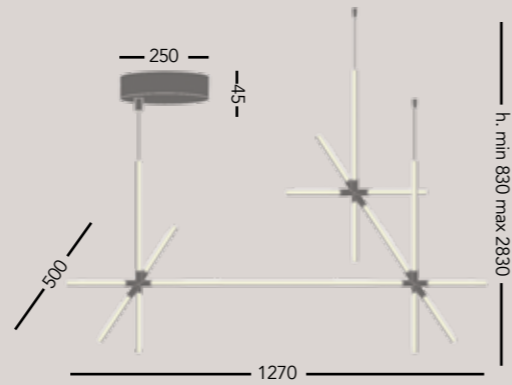

**910/4S**  
 LED 129,36W 24V  
 13200lm - 3000°K  
 upon request  
 2700/4000°K  
 CE IP20  
 Dimmable PUSH

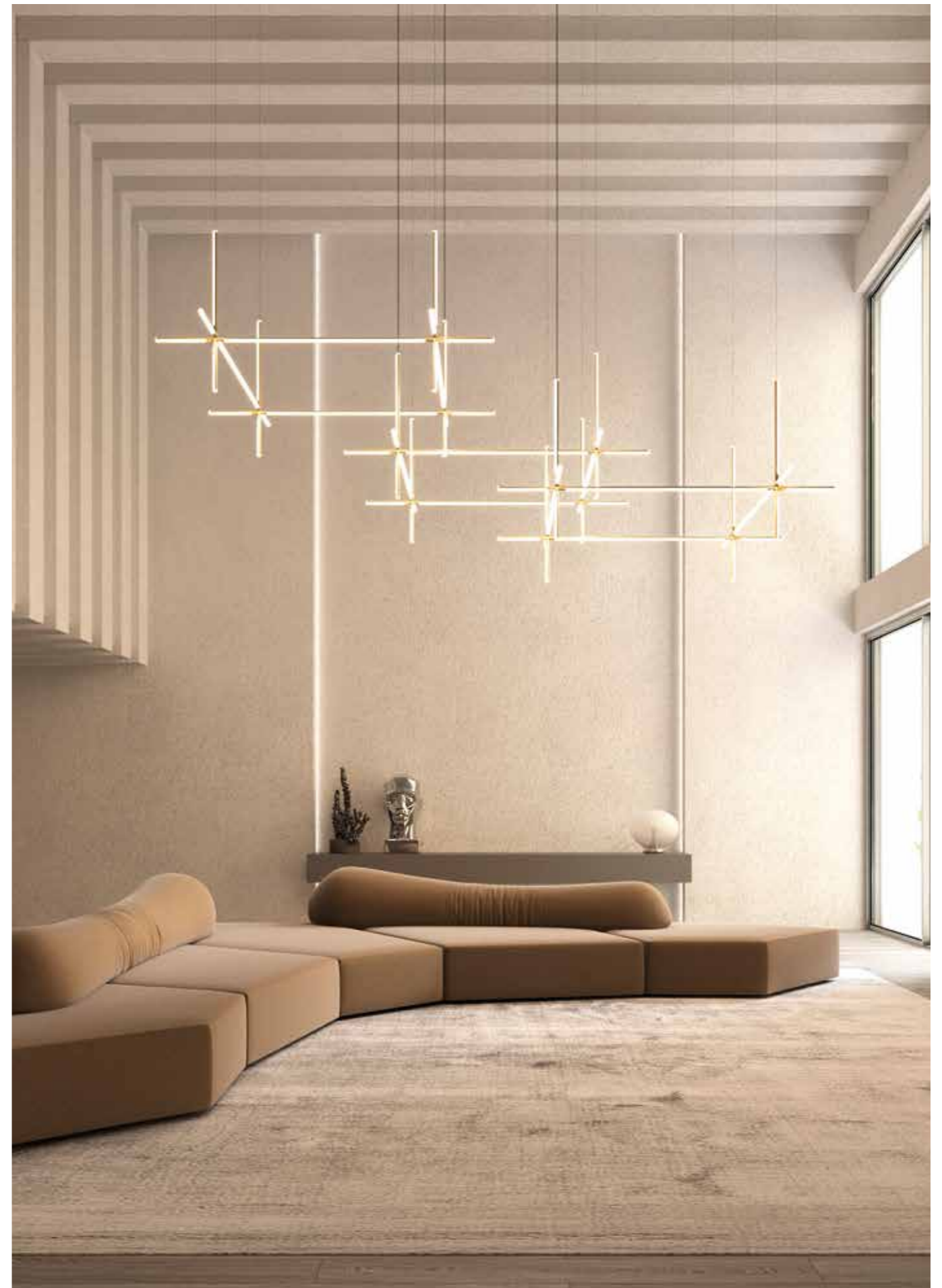
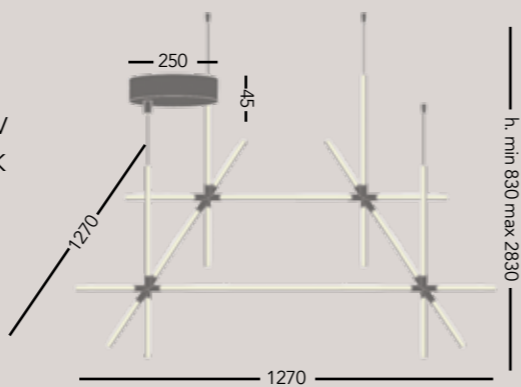

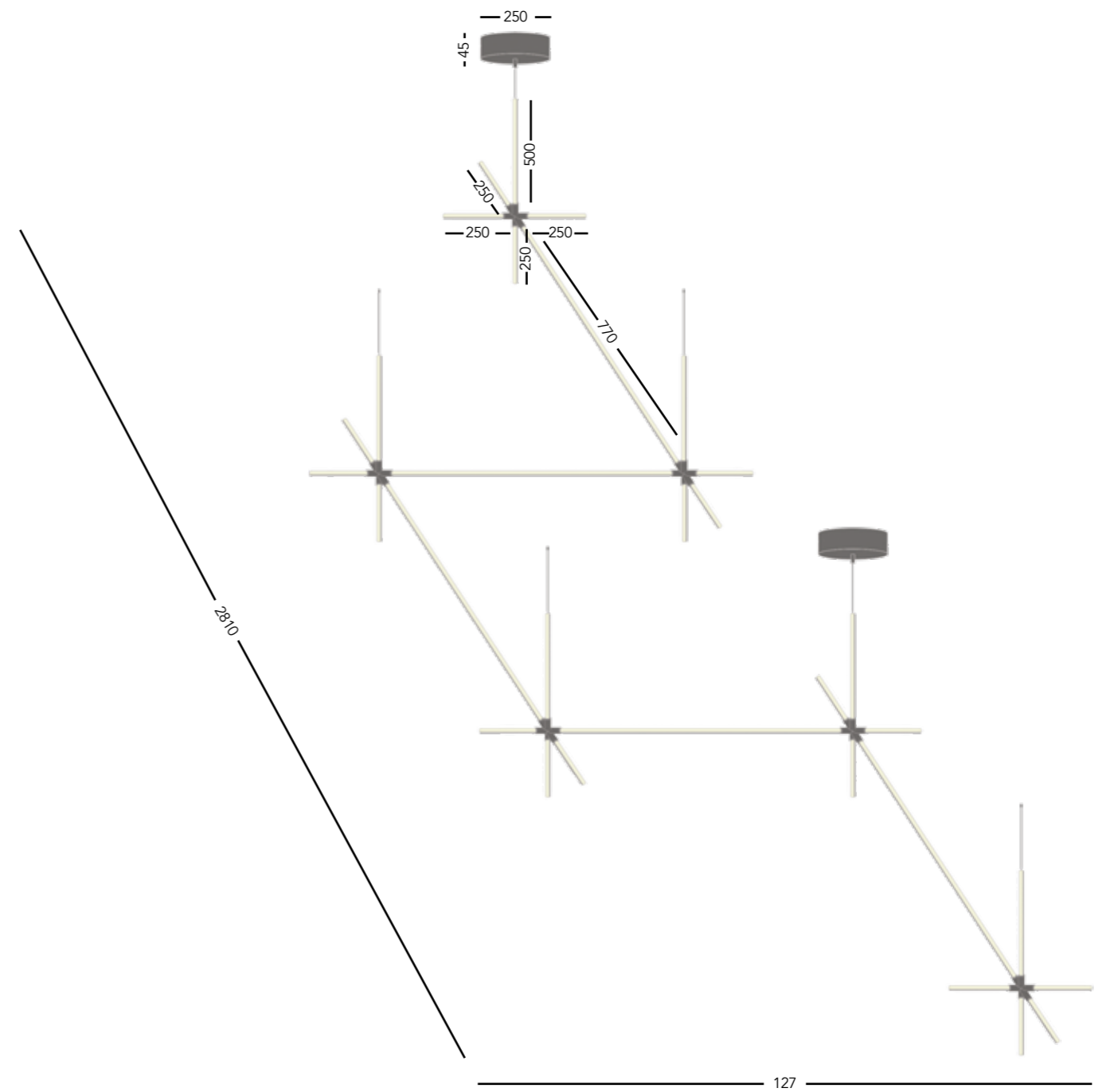

Lucilla System

Installazione realizzata con 2 sospensioni art. **910/3S** + modulo art. **906/70PR**  
**A richiesta tutte le misure possono essere personalizzate.**

Installation realised with 2 suspension ref. code **910/3S** + one module ref. code **906/70PR**  
**On demand all sizes can be customised.**

Installation realisiert mit 2 Aufhängungen art. **910/3S** + Modul art. **906/70PR**  
**Alle Größen können auf Anfrage personalisiert werden.**

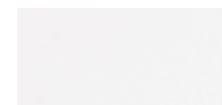

White



Black



Lackered Bronze



Sandy



Lackered Gold

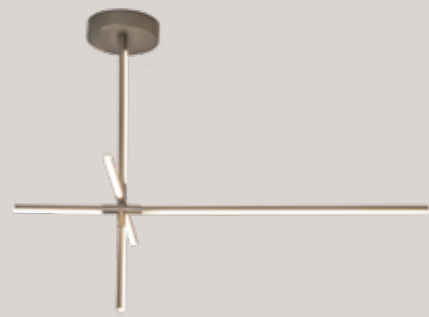

**910/1P**  
 LED 43,120W 24V  
 4400lm - 3000°K  
 upon request  
 2700/4000°K  
 CE IP20  
 Dimmable PUSH

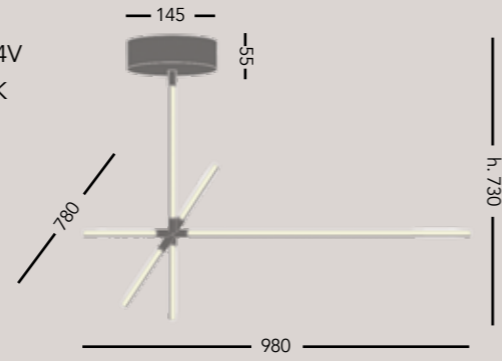

**910/2P**  
 LED 52,92W 24V  
 5400lm - 3000°K  
 upon request  
 2700/4000°K  
 CE IP20  
 Dimmable PUSH

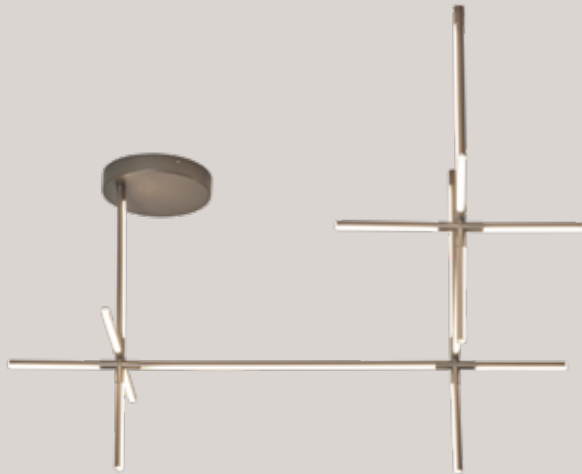
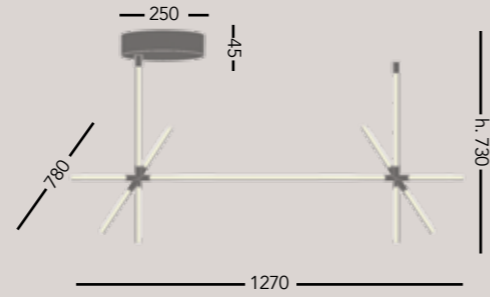

**910/3P**  
 LED 94W 24V  
 960lm - 3000°K  
 upon request  
 2700/4000°K  
 CE IP20  
 Dimmable PUSH

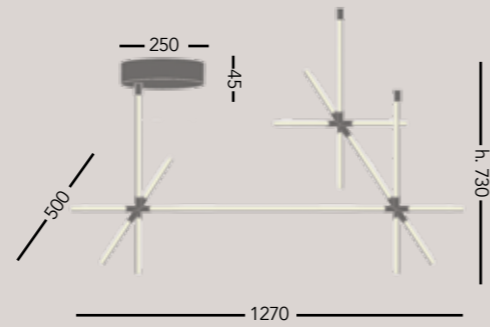

**910/4P**  
 LED 129,36W 24V  
 13200lm - 3000°K  
 upon request  
 2700/4000°K  
 CE IP20  
 Dimmable PUSH

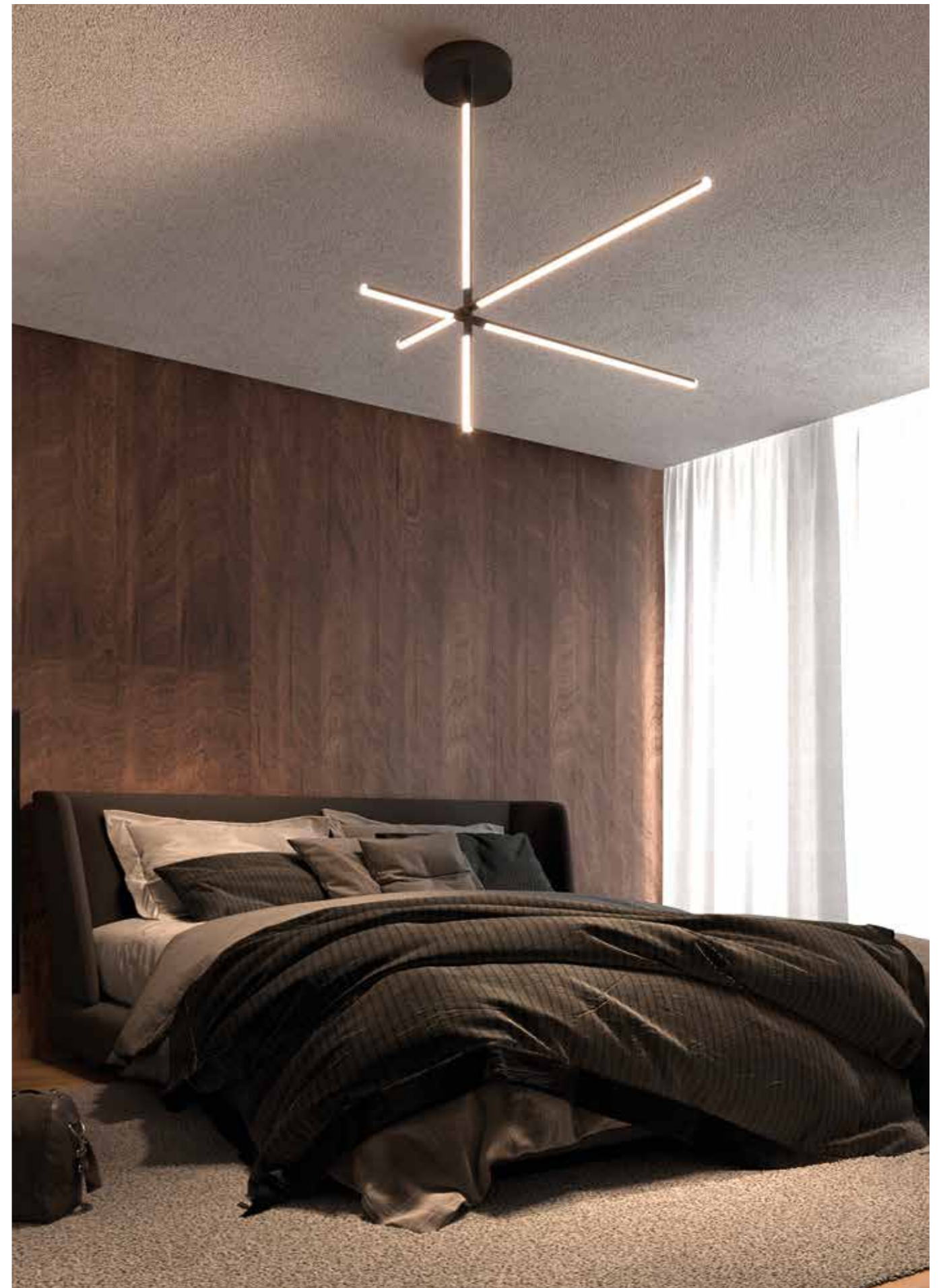
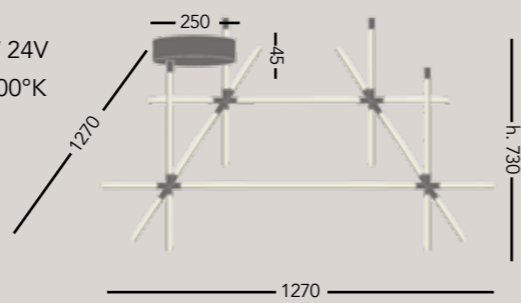

Lucilla System



# Lucilla terra

design by C. Cattaneo

Lucilla, elegante e lineare, è la lampada da terra adatta ad ogni ambiente. Disponibile singola o doppia con altezze diverse, è dotata di dimmer per illuminare l'ambiente in base alle proprie preferenze. Grazie alla sua versatilità si può inclinare, ruotare e creare scenari con luce diretta e/o indiretta.

Lucilla, elegant and linear, is the floor lamp suitable for any environment. Available as a single or double lamp with different heights, it is equipped with a dimmer to light the room according to your preferences. Thanks to its versatility, it can be tilted, rotated and create scenarios with direct and/or indirect light.

Lucilla, elegant und linear, ist die Stehleuchte, die sich für jede Umgebung eignet. Sie ist als Einzel- oder Doppelleuchte in verschiedenen Höhen verfügbar und mit einem Dimmer ausgestattet, um den Raum nach den eigenen Vorlieben zu beleuchten. Wegen ihrer Vielseitigkeit kann sie gekippt und gedreht werden und Szenarien mit direktem und/oder indirektem Licht schaffen.

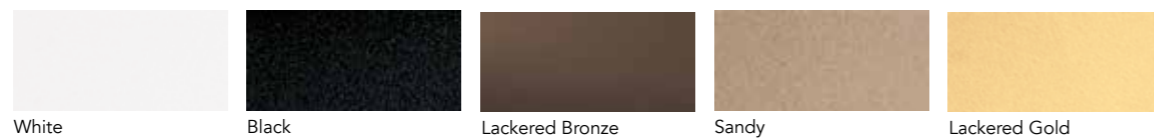
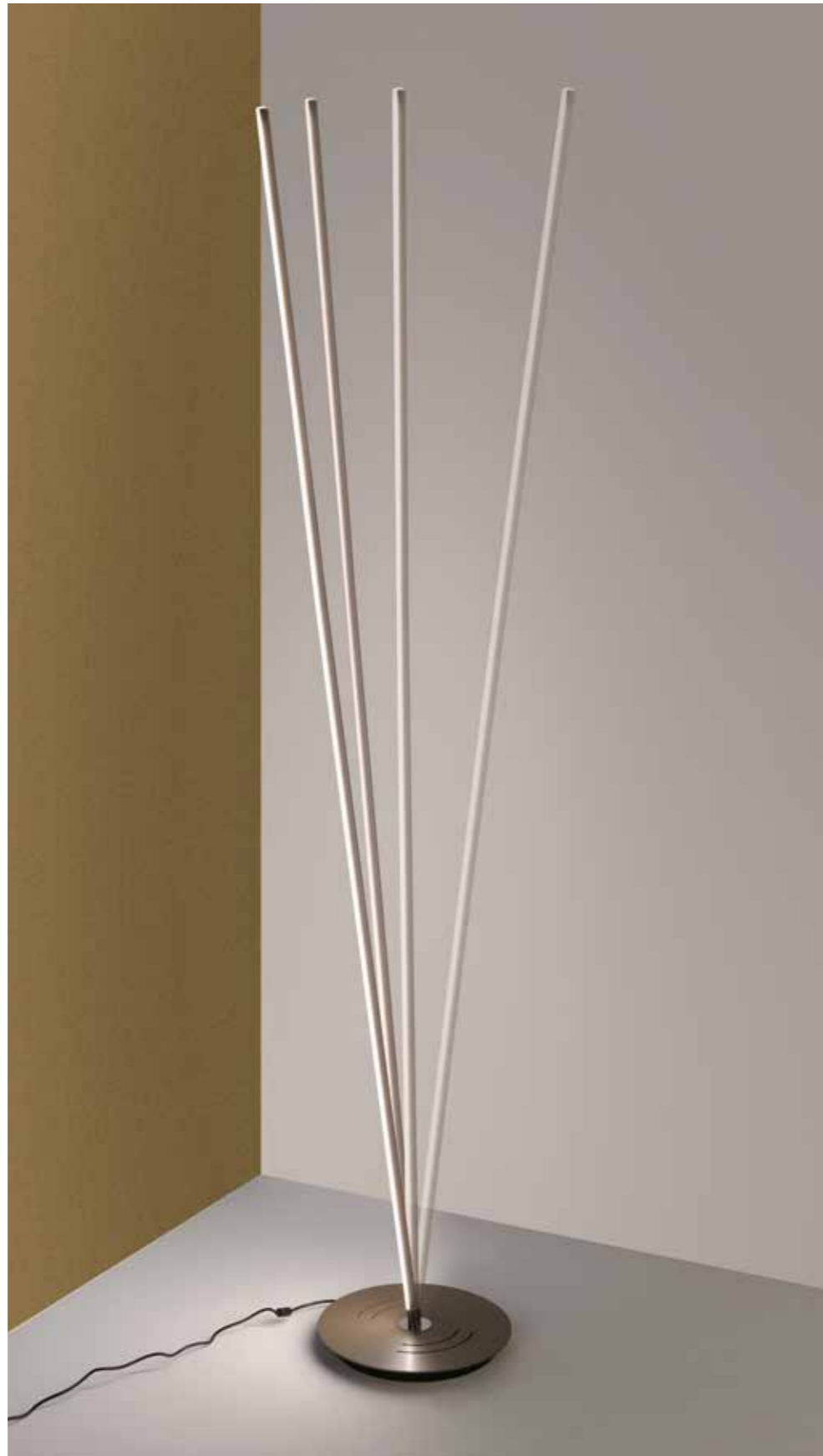

White

Black

Lackered Bronze

Sandy

Lackered Gold



**905/200 T**

LED 38W 24V 220-240V

4000lm - 3000°K upon request 2700-4000°K

CE IP20

2 boxes

Dimmable

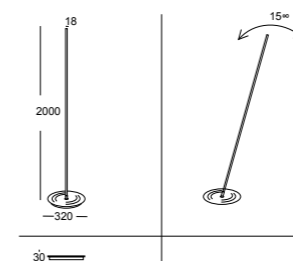

905/200 T



**905/180 T**

LED 34,20W 24V 220-240V

3600lm - 3000°K upon request 2700-4000°K

CE IP20

Dimmable

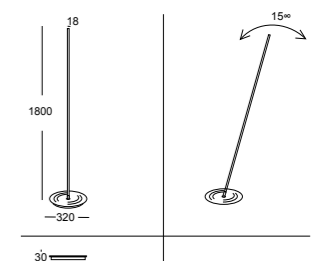

905/180 T

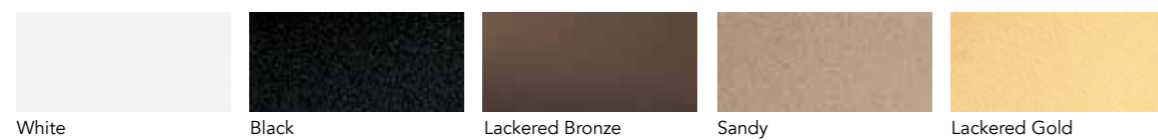

**905/18.20 T2**  
 LED 72,20W 24V 220-240V  
 7600lm - 3000°K upon request 2700-4000°K  
 CE IP20  
 2 boxes  
 Dimmable

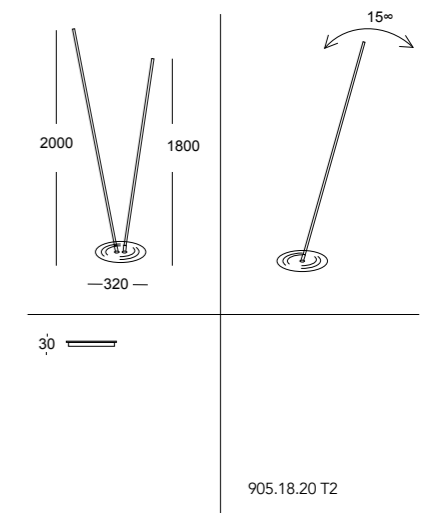



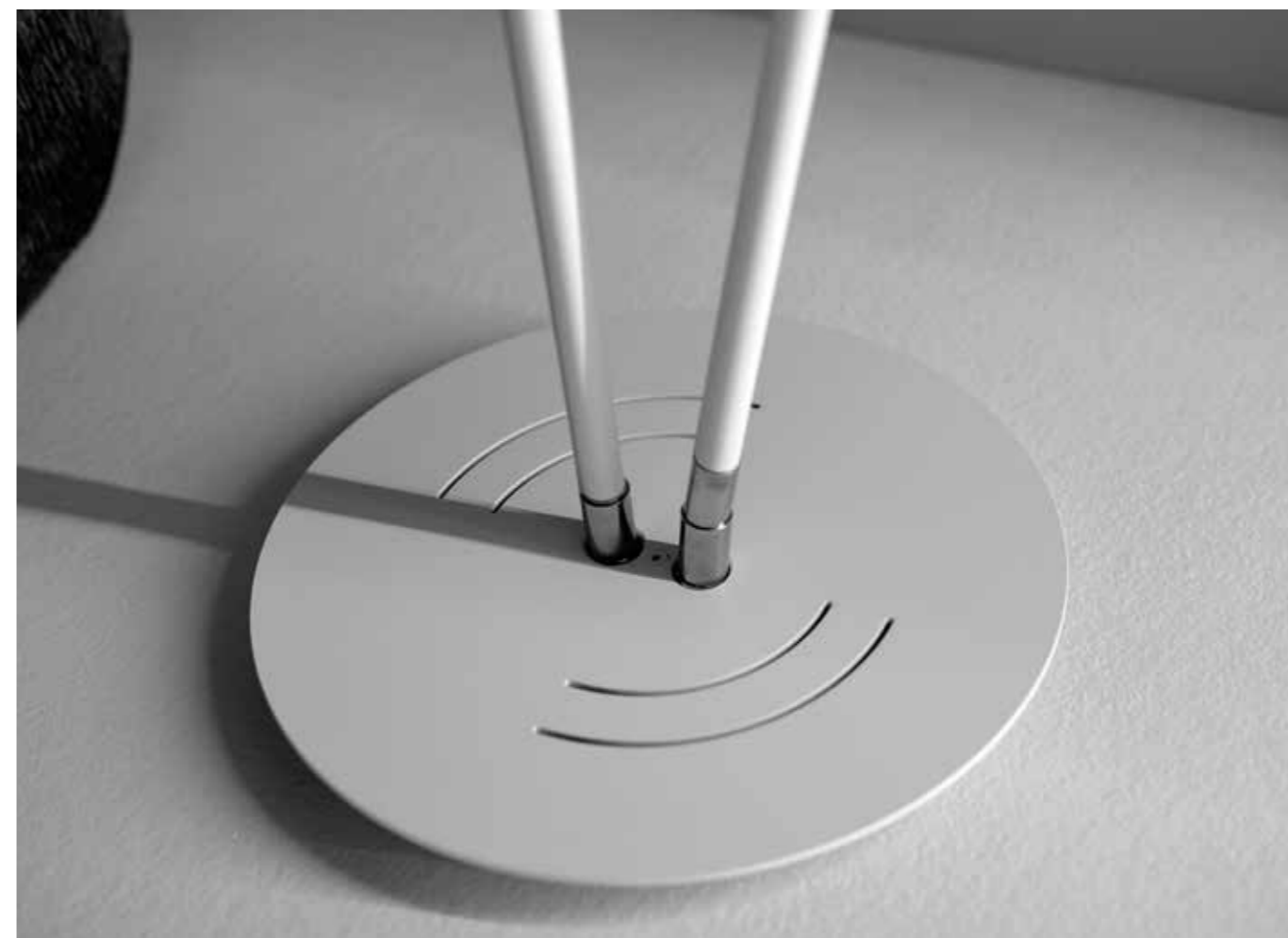

Montaggio facile con innesto jack che consente una rapida installazione.  
Grazie alla sua versatilità si può inclinare, ruotare e creare scenari con luce diretta e/o indiretta.

Easy mounting with a jack plug that allows for quick installation.  
Thanks to its versatility, it can be tilted, rotated and create scenarios with direct and/or indirect light.

Einfache Montage mit einem Klinkenstecker, der eine schnelle Installation ermöglicht.  
Wegen ihrer Vielseitigkeit kann sie gekippt und gedreht werden und Szenarien mit direktem und/oder indirektem Licht schaffen.



Lucilla è dimmerabile con il telecomando incluso, che si può tenere sulla lampada o staccare.

Lucilla is dimmable with the included remote control, which can be held on the lamp or removed.

Lucilla ist dimmbar mit der mitgelieferten Fernbedienung, die an der Leuchte befestigt oder abgenommen werden kann.

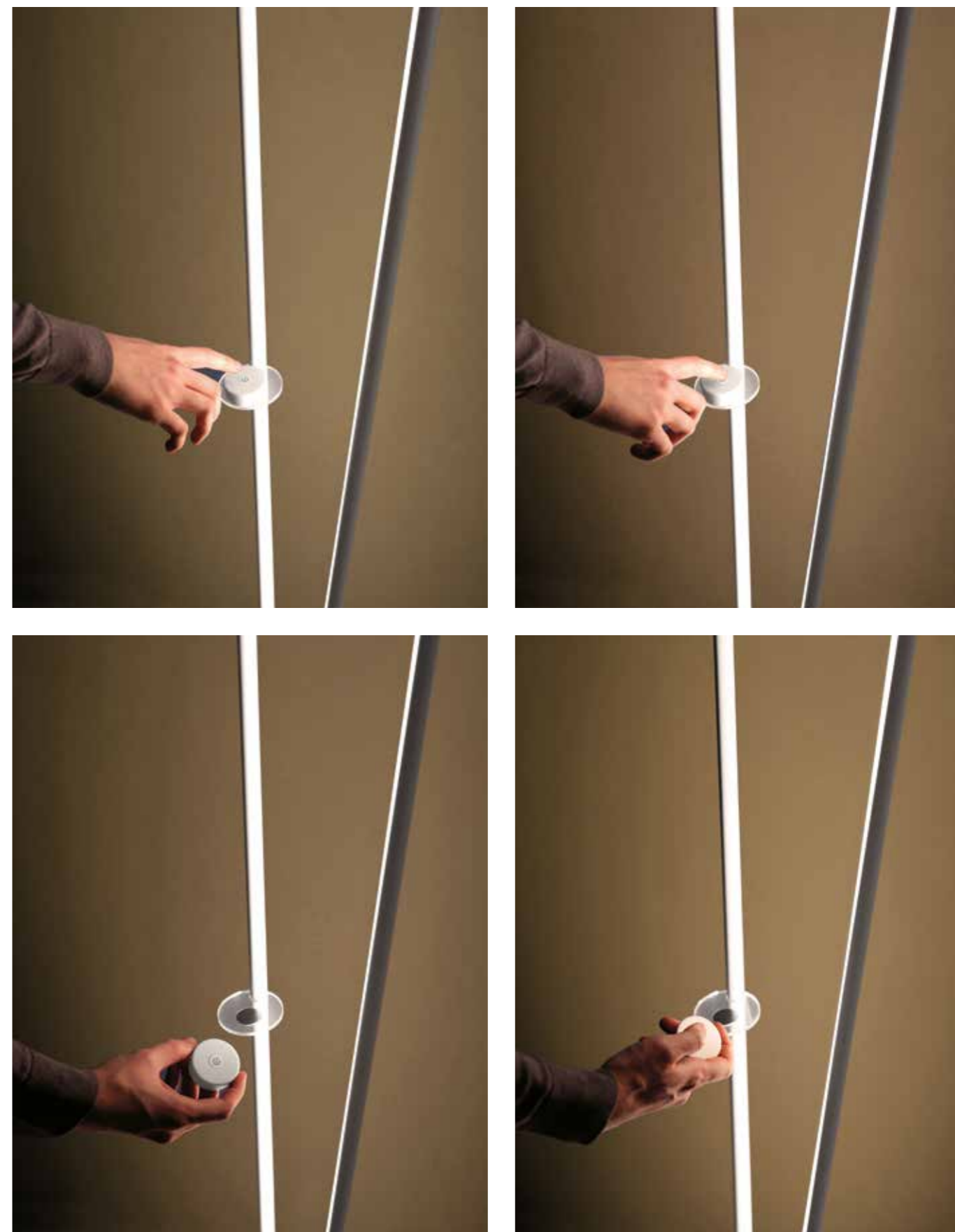

# Lucilla sospensione

design by C. Cattaneo



Una lampada versatile e dinamica, che nella sua leggerezza, permette semplicemente ruotandola di ottenere luce diretta o indiretta adeguandosi all'ambiente e alle esigenze illuminotecniche. Grazie alla sua linea minimal e alla varietà di colorazioni Lucilla si integra perfettamente sia in ambienti stile industrial, che in quelli più classici.

A versatile and dynamic lamp, which, in its lightness, allows simply by rotating it to obtain direct or indirect light, adapting to the environment and lighting requirements.

Thanks to its minimal line and the variety of colours, Lucilla fits perfectly into both industrial and classic style environments.

Eine vielseitige und dynamische Leuchte, die es durch ihre Leichtigkeit ermöglicht, durch einfaches Drehen direktes oder indirektes Licht zu erhalten, das sich an die Umgebung und die Beleuchtungsanforderungen anpasst. Dank seiner minimalistischen Linie und der Farbvielfalt fügt sich Lucilla sowohl in industrielle als auch in klassische Umgebungen ein.



Lucilla | Suspension



**905/120 S**

LED 22,80W 24V  
2400lm - 3000°K upon request 2700-4000°K

CE IP20  
Dimmable PHASE-CUT DIMMING

**905/140 S**

LED 26,60W 24V  
2800lm - 3000°K upon request 2700-4000°K

CE IP20  
Dimmable PHASE-CUT DIMMING

**905/180 S**

LED 34,20W 24V  
3600lm - 3000°K upon request 2700-4000°K

CE IP20  
Dimmable PHASE-CUT DIMMING

**905/200 S**

LED 38W 24V  
4000lm - 3000°K upon request 2700-4000°K

CE IP20  
Dimmable PHASE-CUT DIMMING

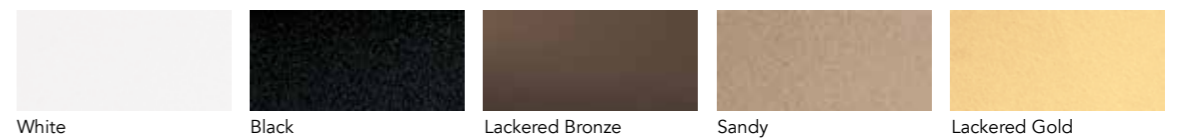
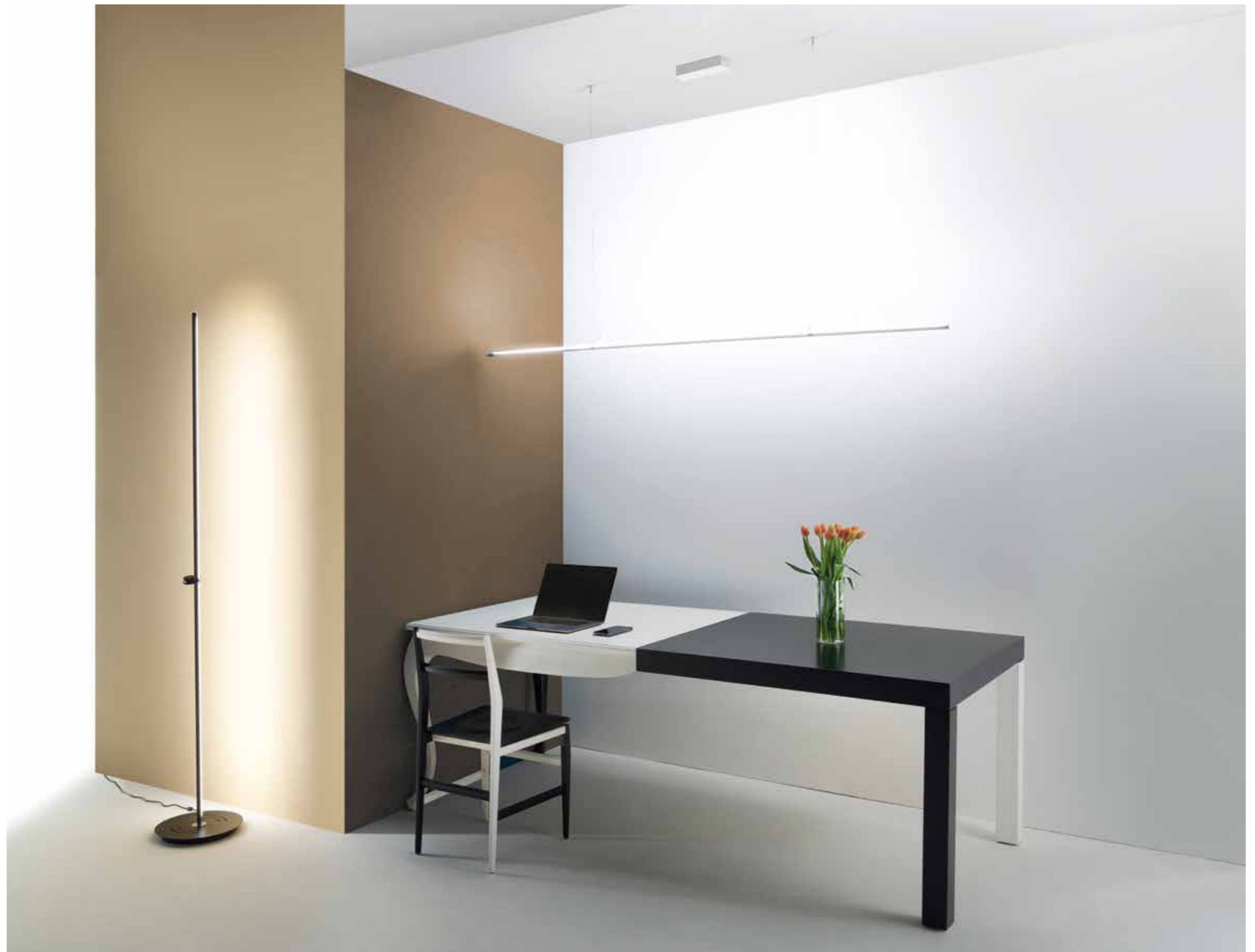
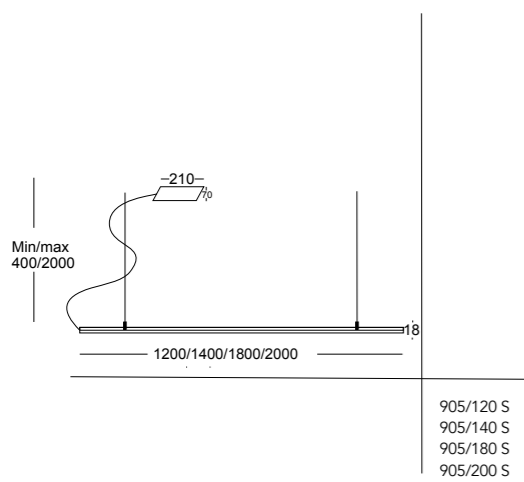

# Lucilla parete, plafone

design by C. Cattaneo

Lampada da parete e plafone, versatile a luce diretta e/o indiretta.  
Disponibile in diverse misure e colorazioni con 1 o 2 luci.

Adjustable wall and ceiling lamp, versatile for direct and/or indirect light.  
Available in different sizes and colours with 1 or 2 lights.

Wandleuchte, vielseitig einsetzbar mit direktem und/oder indirektem Licht.  
Erhältlich in verschiedenen Größen und Farben mit 1 oder 2 Leuchten.

**905/60 PA1**

LED 11,40W 24V  
1200lm - 3000°K upon request 2700-4000°K  
CE IP20

**905/60 PA2**

LED 22,80W 24V  
2400lm - 3000°K upon request 2700-4000°K  
CE IP20

**905/80 PA1**

LED 15,20W 24V  
1600lm - 3000°K upon request 2700-4000°K  
CE IP20

**905/80 PA2**

LED 30,40W 24V  
3200lm - 3000°K upon request 2700-4000°K  
CE IP20

**905/100 PA1**

LED 19W 24V  
2000lm - 3000°K upon request 2700-4000°K  
CE IP20

**905/100 PA2**

LED 38W 24V  
4000lm - 3000°K upon request 2700-4000°K  
CE IP20

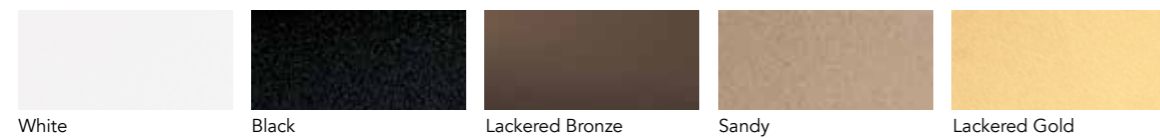
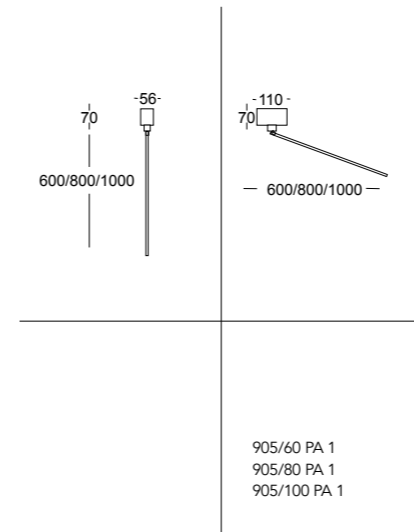





**905/60 PA1**

LED 11,40W 24V  
1200lm - 3000°K upon request 2700-4000°K  
CE IP20

**905/60 PA2**

LED 22,80W 24V  
2400lm - 3000°K upon request 2700-4000°K  
CE IP20

**905/80 PA1**

LED 15,20W 24V  
1600lm - 3000°K upon request 2700-4000°K  
CE IP20

**905/80 PA2**

LED 30,40W 24V  
3200lm - 3000°K upon request 2700-4000°K  
CE IP20

**905/100 PA1**

LED 19W 24V  
2000lm - 3000°K upon request 2700-4000°K  
CE IP20

**905/100 PA2**

LED 38W 24V  
4000lm - 3000°K upon request 2700-4000°K  
CE IP20

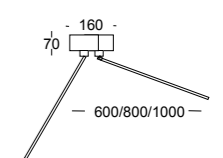
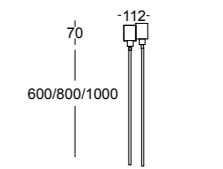

905/60 PA 2  
905/80 PA 2  
905/100 PA 2

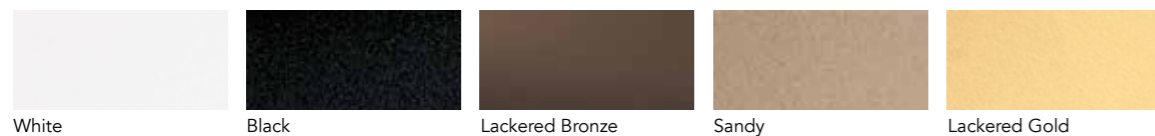



# Rays

design by C. Cattaneo



Serie composta da sospensioni, parete e plafone che grazie alla sua originale forma permette una scenografica installazione sia in ambienti moderni che classici.

A complete family consisting of suspension, wall and ceiling lamps that, thanks to its original shape, allows for a scenic installation in both modern and classical settings.

Eine komplette Familie, bestehend aus Pendel-, Wand- und Deckenleuchten, die dank ihrer originellen Form sowohl in modernen als auch in klassischen Räumen eingesetzt werden kann.



White

Black

Sandy

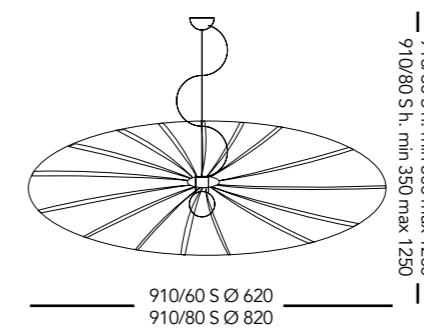
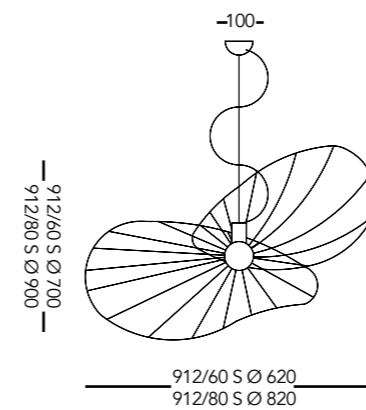

**912/80 S**  
220-240V - E27 LED  
CE IP20

**913/80 S**  
220-240V - E27 LED  
CE IP20

**912/60 S**  
220-240V - E27 LED  
CE IP20

**913/60 S**  
220-240V - E27 LED  
CE IP20



**912/80 PA**  
220-240V - E27 LED  
CE IP20

**912/60 PA**  
220-240V - E27 LED  
CE IP20

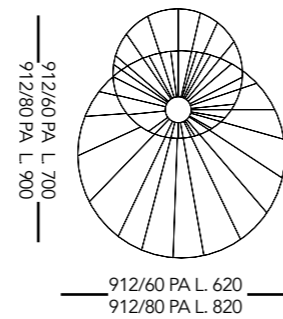

912/60 PA h. 200  
912/80 PA h. 200

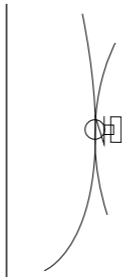

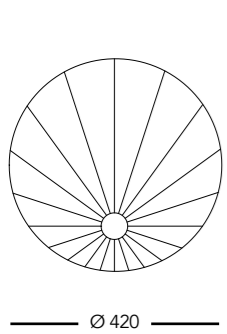
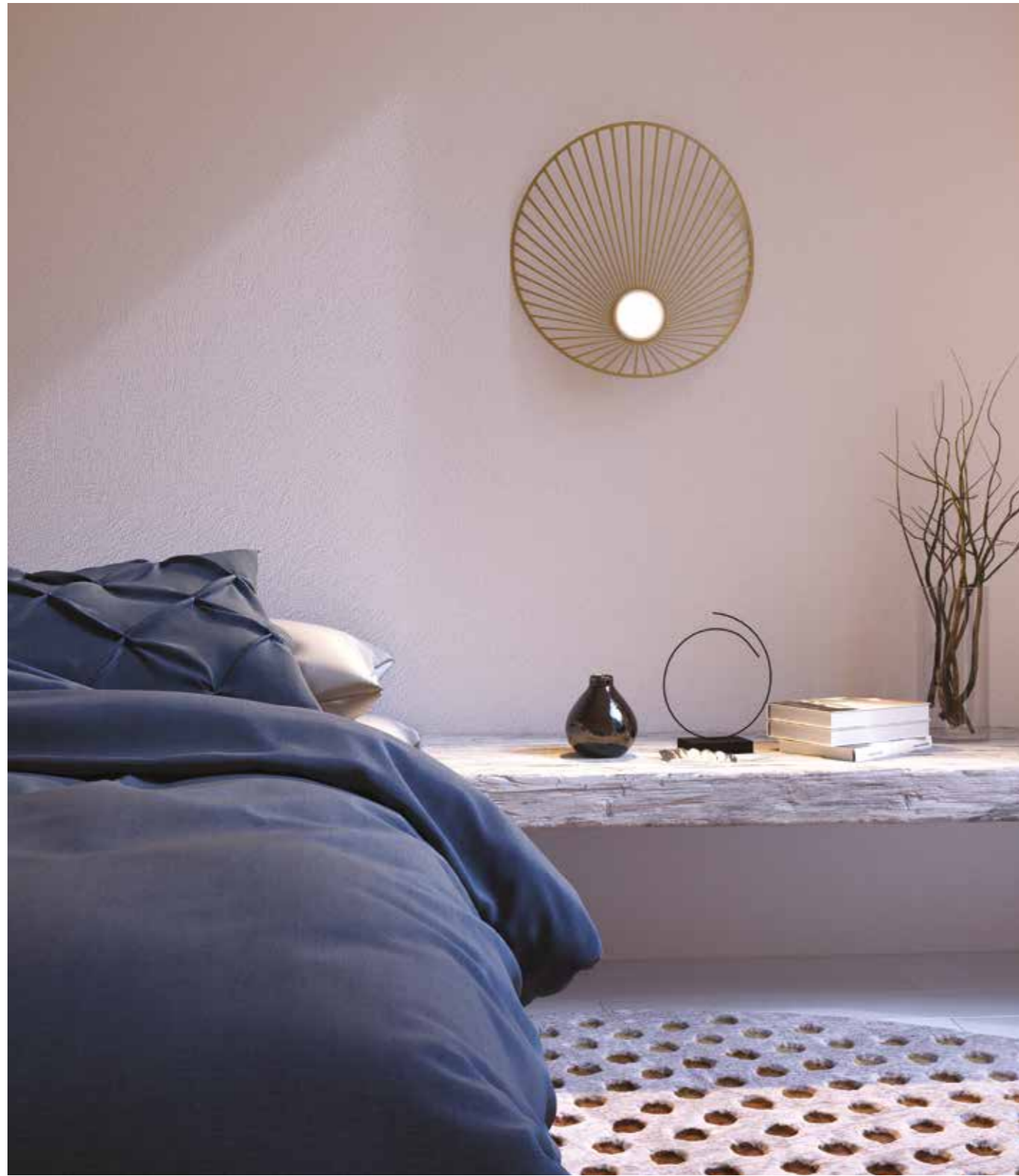

—120—  
**914/40 PA**  
 220-240V - GX53 LED  
 CE IP20

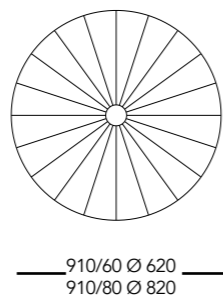

—200—  
**913/60 PA**  
 220-240V - E27 LED  
 CE IP20

—130—  
**913/80 PA**  
 220-240V - E27 LED  
 CE IP20



# Vintage

design by C. Cattaneo

Vintage | Wall, Ceiling

Lampada da parete, plafone e sospensione studiata per fantasiosi giochi luminosi.

Wall, ceiling and suspension lamp designed for imaginative light games

Wand-, Decken- und Hängeleuchte für fantasievolle Lichtspiele.



**976/14 PA**  
 220-240V - GX53 LED  
 CE IP20

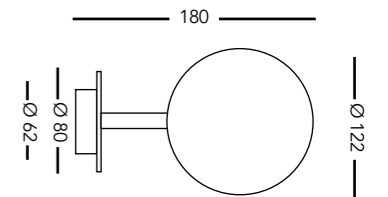



# Mickey

design by C. Cattaneo



Luminosa ed appariscente, Mickey la lampada da parete e plafone che, con il suo design armonioso e divertente, illuminerà le stanze della tua casa rendendole piacevoli e lucenti.

Bright and eye-catching, Mickey is a wall and ceiling lamp with a funny and harmonious design. It will light the rooms of your house up, making them pleasant and shining.

Hell und auffällig, die Wand- und Deckenlampe Mickey. Mit ihrem harmonischem und unterhaltsamen Design werden alle Räume erhellt und glänzend ausgestrahlt.

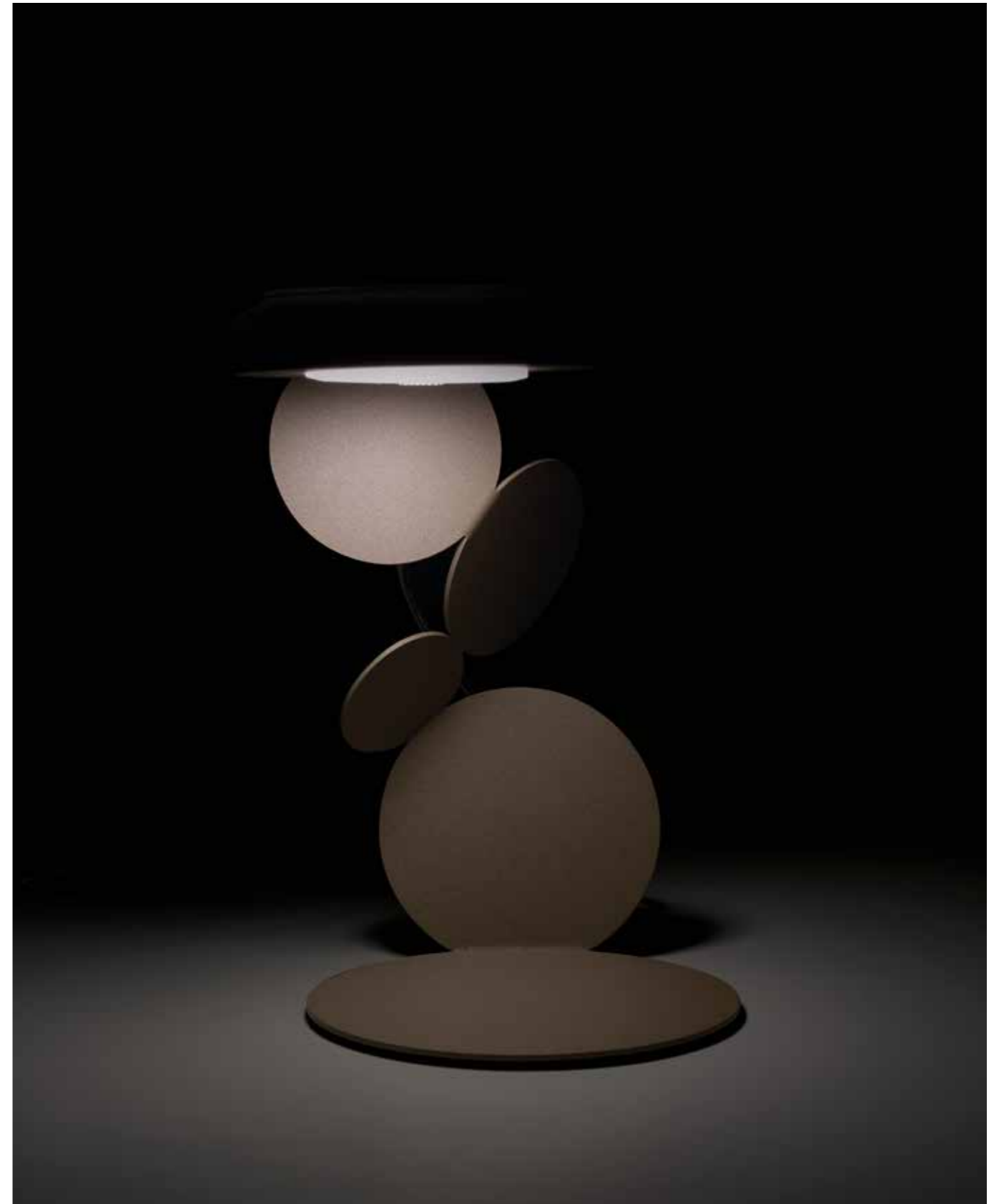

**861/1 L**  
 220-240V - GX53 LED  
 CE IP20

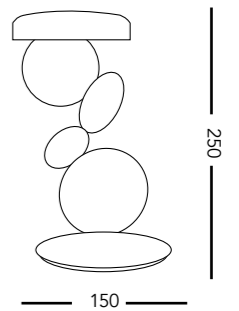

Graphic design  
Bordegoni

Photography  
Bordegoni

Copyright © Cattaneo sas 2020

Reference images by gracious permission  
of our customers

Cattaneo Illuminazione si riserva la facoltà  
di modificare, in qualsiasi momento e senza  
preavviso, le caratteristiche tecniche dei  
modelli illustrati nel presente catalogo.  
I colori si intendono indicativi.

Cattaneo illuminazione reserves the right to  
change the technical features of the items  
in the catalogue at any time without prior  
notice.

The colours shown are intended to show  
the approximate colour of the finish.

Cattaneo Illuminazioni behält sich  
das Recht vor, jederzeit und ohne  
vorherige Ankündigung, die technischen  
Eigenschaften der Modelle in diesem  
Katalog zu modifizieren.  
Die Farben sind indikativ.

**Cattaneo**

Via P. da Volpedo, 10  
20092 Cinisello Balsamo  
Milano - Italy  
t. (+39) 02 6604.6582  
t. (+39) 02 6601.8303  
cattaneo@cattaneo.it  
export@cattaneo.it

[www.cattaneo.it](http://www.cattaneo.it)