



C·V·L

MANUFACTURE

Collection Luminaires 2023-2024



CVL MANUFACTURE

FABRICANT FRANÇAIS DEPUIS PLUS DE 60 ANS.

Savoir-Faire.

Entreprise française fondée en 1960, CVL revendique ses racines artisanales et un savoir-faire unique dans la fabrication entièrement « fait main » de luminaires décoratifs en laiton massif.

Détentrice d'une expertise acquise au cours de six décennies, l'entreprise familiale a patiemment établi sa marque grâce à des collections élégantes destinées au grand public comme aux professionnels, distribuées à travers un réseau de magasins spécialisés passionnés et fidèles. L'originalité des courbes, l'intemporalité des modèles, et la qualité des décors et finitions du laiton, font des produits CVL une valeur sûre, unique et durable dans l'offre d'éclairage décoratif.

Engagements.

Depuis de nombreuses années, la marque souhaite proposer des produits éthiques et respectueux de l'environnement. Ainsi, CVL s'inscrit dans une démarche vertueuse de développement durable. L'unité de production bénéficie d'une installation répondant à toutes les normes en vigueur.

Une station de recyclage interne assure un fonctionnement « rejet zéro » : les métaux polluants et les eaux des bains de rinçage sont retraités et ne sont pas rejetés dans le milieu naturel.

La cellule de développement est aussi en veille permanente sur l'évolution des technologies et des normes et s'appuie sur le laboratoire de test interne pour s'assurer de la conformité de ses créations.

Pour une qualité irréprochable, chaque produit est vérifié et testé avant emballage. Enfin, la PME familiale s'attache à transmettre son savoir-faire ancestral en formant chaque année de nouveaux collaborateurs, participant au maintien d'emplois qualifiés sur le territoire.

Collections.

La collection CVL Manufacture est destinée aussi bien aux détaillants pour la vente aux particuliers qu'aux prescripteurs pour des projets résidentiels, hôteliers et commerciaux.

Le bureau de création interne fait évoluer les gammes en permanence, les modèles « classiques intemporels » laissant également la part belle à des collections plus récentes et plus contemporaines, toujours dans l'esprit CVL. Nos luminaires trouvent leur place dans tous les intérieurs.

En 2014, l'entreprise impulse un virage vers le design et complète son offre avec une gamme résolument plus contemporaine destinée aux prescripteurs. CVL obtient rapidement l'approbation de nouveaux clients - architectes et designers - en France et dans le monde entier, lesquels apprécient le savoir-faire unique de nos ateliers et le raffinement de nos luminaires.





NOS FINITIONS

FINITIONS DE BASE

BR
LAITON BRUNI

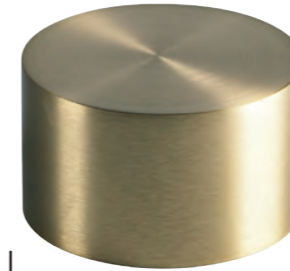

SG
GRAPHITE

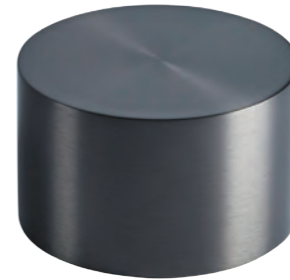

SN
NICKEL



FINITIONS SPÉCIFIQUES

Disponibles uniquement sur certains produits.

SB
LAITON SATINE



SC
CUIVRE



PB
LAITON POLI



PN
NICKEL POLI



GLOSSAIRE

COMPRENDRE LE CATALOGUE



NB: Nos dimensions sont données à titre indicatif et peuvent varier légèrement selon le modèle de verreries.

Finitions



Finitions disponibles pour ce produit.

Verreries



Verreries disponibles avec ce produit. Voir page 156 pour vues détaillées.

Compléments

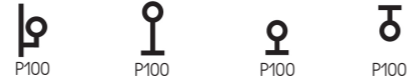

applique lampadaire lampe suspension de la même collection

PRENDRE SOIN DE VOTRE LUMINAIRE

Essuyage avec un chiffon doux.

Nos luminaires étant vernis afin d'assurer la longévité du produit, il ne faut en aucun cas utiliser de produits détergents ou de solvants.

COMPRENDRE LES ÉQUIVALENCES LED / ANCIENNES AMPOULES

Il était d'usage de choisir l'ampoule selon sa puissance électrique en Watt. Or, la puissance électrique correspond à la consommation électrique et non au rendu lumineux.

Depuis l'apparition des ampoules LEDs, qui consomment très peu, il est difficile de faire le choix de l'ampoule la plus adaptée.

Voici quelques conseils qui vous aiderons dans le choix d'une ampoule Led:

- Le critère déterminant pour le choix d'une ampoule est le flux lumineux que l'on souhaite obtenir. Ce dernier se mesure en Lumen (lm), unité correspondant à la quantité de lumière restituée par l'ampoule.

Plus le nombre de lumens est élevé, plus le flux lumineux est important !

- La température de la lumière est également une caractéristique importante. Elle s'exprime en Kelvin (K) et pour les ampoules, varie de 2700 K (lumière chaude) à 6000 K (lumière très froide).

- Attention à la variation : Les ampoules LEDs ne sont pas toutes variables. Si vous souhaitez pouvoir faire varier votre luminaire, veillez à utiliser une ampoule «variable» ou «dimmable».

TABLEAU D'ÉQUIVALENCES LED / ANCIENNES AMPOULES

LES AMPOULES NE SONT PAS INCLUSES DANS NOS PRODUITS.

Le tableau ci-dessous est fourni à titre indicatif et ses données peuvent différer d'un fabricant d'ampoule à l'autre.

Consommation d'une ampoule incandescente en Watt (W)	20 W	40 W	60 W	75 W	100 W	150 W	250 W
Flux Lumineux en Lumen (lm)	200 lm	470 lm	650 lm	800 lm	1300 lm	2100 lm	3500 lm
Consommation d'une ampoule LED en Watt (W)	2 à 4 W	3 à 5 W	5 à 8 W	8 à 10W	10 à 15 W	15 à 20 W	25 à 28 W

SOMMAIRE

PAGE 15 LES SUSPENSIONS



PAGE 89 LES APPLIQUES



PAGE 115 LES LAMPES



PAGE 125 LES LAMPADAIRES



PAGE 133 LES RÉFLECTEURS TABLEAUX



PAGE 141 LA GAMME CLASSIQUE



PAGE 147 LA GAMME BILLARD





INDEX

B

61 Bombay

C

141 Châtelet
128 Circé
148 Creil

D

102 Diapason Applique
21 Diapason Lustres
89 Dots

E

151 Eragny

G

67 Gaïa
108 Génésis
35 Globule
153 Goudet
154 Guérande

H

120 Hades
83 Halo
55 Heka
47 Hévée
40 Hypnos

I

112 Iliade

K

149 Kimi
150 Koloa

L

73 Laika
43 Léto
155 Lisieux
76 Luna

M

62 Maori
152 Mayenne
155 Mercure
39 Morphée
61 Mumbai

N

106 Nata Applique
31 Nata Lustre
100 Nectar
152 Neptune
43 Niobé
122 Nymphéa

O

64 Oriya
49 Osiris Lustre
113 Osiris Applique

P

126 Paola
80 Perla
68 Pompéi
61 Poona
71 Prague
110 Priam

R

96 Ruche

S

57 Sabia
127 Sakura
58 Senja
56 Siam
27 Smile
109 Sparte
58 Syra

T

123 Talisman
33 Tess Lustre
118 Tess Lampe
130 Tess Lampadaire

V

156 Verreries
71 Vésuve

W

104 Wool Applique
15 Wool Lustre
115 Wool Lampe

134 5000 réflecteurs
138 6000 réflecteurs
136 9000 réflecteurs

LES SUSPENSIONS



WOOL

WOOL

LUSTRE
WOOL 4L SN DE07/09

G9 4 x 4W LED maxi



LUSTRE
WOOL 6L SB/SG DE07/09

G9 6 x 4W LED maxi

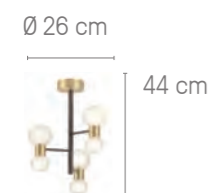

Finitions



BICOLORE
disponible
voir détails p158

Verreries



INFORMATIONS IMPORTANTES !

Dimensions ampoules G9 LED à respecter :
Hauteur maximum : 53 mm
Diamètre maximum : 18 mm

Compléments

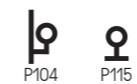

WOOL

LUSTRE
WOOL 10L SN/SG DE07/09

G9 10 x 4W LED maxi

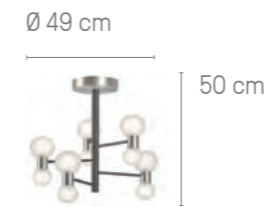

LUSTRE
WOOL 12L SB DE07/09

G9 12 x 4W LED maxi



WOOL

PLAFONNIER
 WOOL R8 ROND SG DE07/09
 G9 8 x 4W LED maxi



PLAFONNIER
 WOOL R12 ROND SB DE07/09
 G9 12 x 4W LED maxi

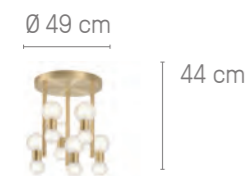

Finitions



BICOLORE
 disponible
 voir détails p158

Verreries



INFORMATIONS IMPORTANTES !

Dimensions ampoules G9 LED à respecter :
 Hauteur maximum : 53 mm
 Diamètre maximum : 18 mm

Compléments

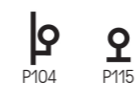

WOOL

PLAFONNIER
 WOOL L12 LONG SB/SG DE07/09
 G9 12 x 4W LED maxi

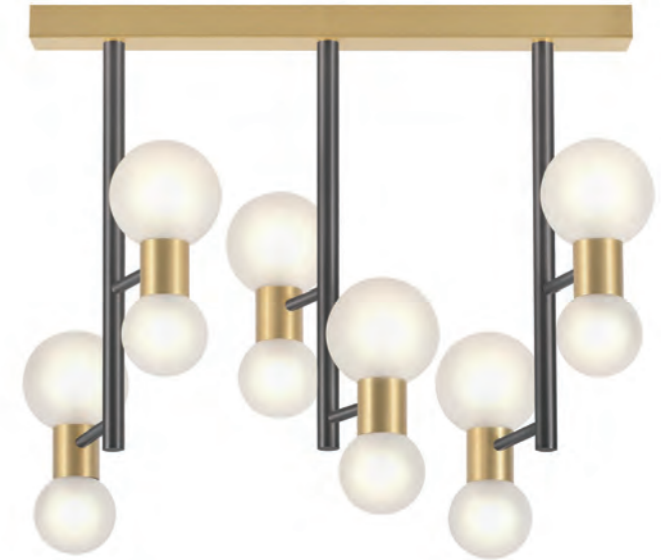

PLAFONNIER
 WOOL L16 LONG SN DE07/09
 G9 16 x 4W LED maxi





DIAPASON

DIAPASON

LUSTRE
DIAPASON 79 6L SG/SB OP10 & OP12

G9 6x 5W LED maxi

Ø 79cm



HAUTEUR
Livrée : 140 cm
Mini : 40 cm



PLAFONNIER
DIAPASON 79 6L SG/SN DE09 & DE12

G9 6x 5W LED maxi

Ø 79cm



40 cm



Finitions



BICOLORE
disponible
voir détails p158

Verreries

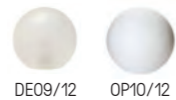

Compléments



DIAPASON

LUSTRE
DIAPASON 100 6L SG DE09 & DE12

G9 6x 5W LED maxi

Ø 100cm



HAUTEUR
Livrée : 140 cm
Mini : 40 cm



PLAFONNIER
DIAPASON 100 6L SB DE09 & DE12

G9 6x 5W LED maxi

Ø 100cm



40cm



DIAPASON

PLAFONNIER
DIAPASON 58 3L SG/SB DE09 & DE12
G9 3x 5W LED maxi

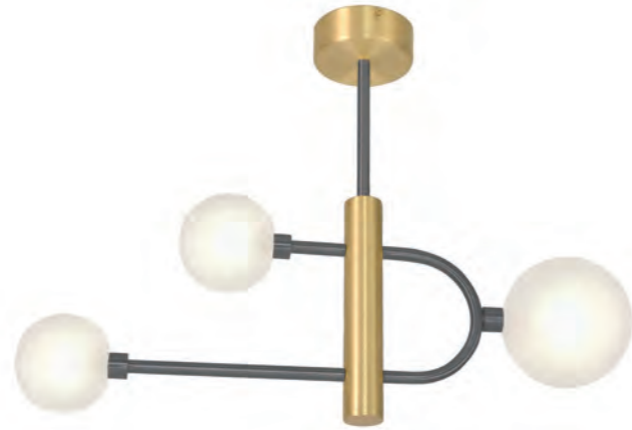
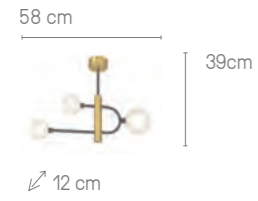

PLAFONNIER
DIAPASON 58 3L SG OP10 & OP12
G9 3x 5W LED maxi



Finitions



BICOLORE
disponible
voir détails p158

Verreries



Compléments



DIAPASON

PLAFONNIER
DIAPASON 69 3L SG/SN DE09 & DE12
G9 3x 5W LED maxi

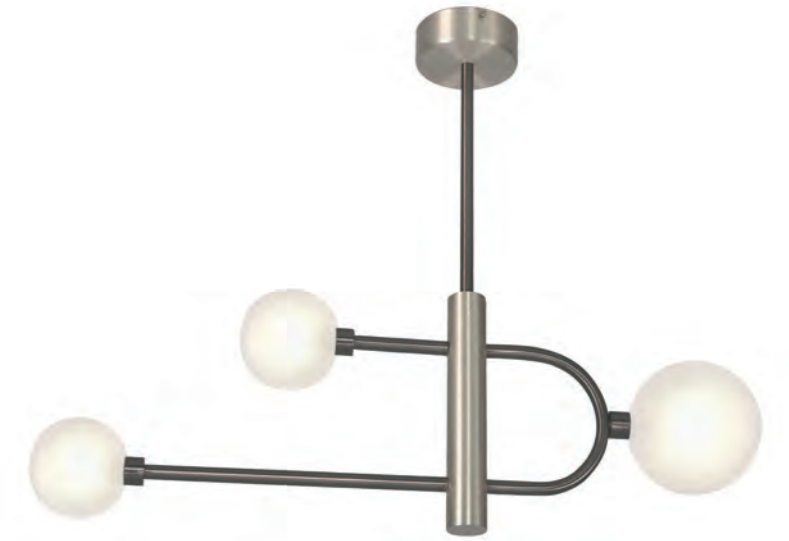
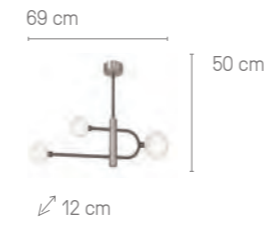

PLAFONNIER
DIAPASON 69 3L SB OP10 & OP12
G9 3x 5W LED maxi

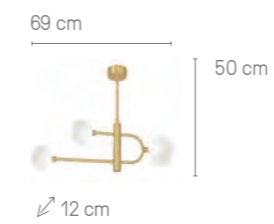



SMILE

LUSTRE
SMILE 5L SN DE09
G9 5x 5W LED maxi

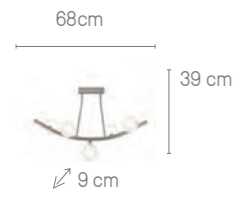

LUSTRE
SMILE 5L SG DE09
G9 5x 5W LED W maxi

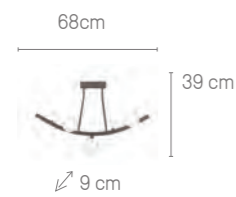

Finitions



Verreries



SMILE

LUSTRE
SMILE 7L SG DE09 & DE12
G9 7x 5W LED maxi

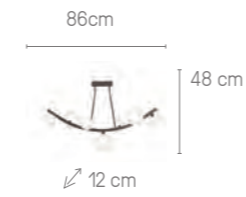

LUSTRE
SMILE 7L SB OP10 & OP12
G9 7x 5W LED maxi

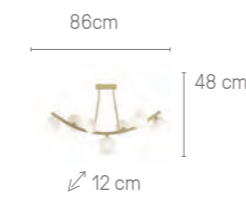

Finitions



Verreries





NATA

LUSTRE
 NATA 10L SN TU10 OPALE
 G9 10x 5W LED maxi

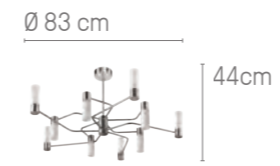

LUSTRE
 NATA 6L BR/SG TU12 CLAIRE
 G9 6x 5W LED maxi



Finitions



BICOLORE
 disponible
 voir détails p158

Verreries



Compléments



TESS

LUSTRE
TESS 6L SG TU10 OPALE

G9 6x 5W LED maxi

Ø 68 cm



LUSTRE
TESS 6L SN TU12 CLAIRE

G9 6x 5W LED maxi

Ø 68 cm



Finitions



BICOLORE
disponible
voir détails p158

Verreries



Compléments



TESS



GLOBULE

LUSTRE
GLOBULE 7L SN DE09

G9 7x 5W LED maxi

Ø 79cm



HAUTEUR
Livrée : 172 cm
Mini : 22 cm



LUSTRE
GLOBULE 5L SG OP10

G9 5x 5W LED maxi

Ø 60cm



HAUTEUR
Livrée : 121 cm
Mini : 21 cm



Finitions



BICOLORE
disponible
voir détails p158

Verreries



GLOBULE

LUSTRE
GLOBULE 9L SB DE09

G9 9x 5W LED maxi

Ø 94cm



HAUTEUR
Livrée : 175 cm
Mini : 25 cm



LUSTRE
GLOBULE 3L SB/SG DE09

G9 3x 5W LED maxi

Ø 42cm



HAUTEUR
Livrée : 121 cm
Mini : 21 cm





MORPHÉE 18

MORPHÉE

LUSTRE
MORPHÉE 12L BR S100

G9 12x 5W LED maxi

Ø 115 cm



Livré : 212 cm
Mini : 80 cm

LUSTRE
MORPHÉE 18L SN S100

G9 18x 5W LED maxi

Ø 141 cm



Livré : 220 cm
Mini : 88 cm



Finitions

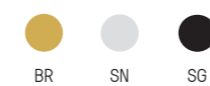

BICOLORE disponible
voir détails p160

LÉTO

Verreries



Compléments



HYPNOS

LUSTRE
HYPNOS 9L BR OP10

G9 9x 5W LED maxi

Ø 85 cm



Livré : 102 cm
Mini : 62 cm



MORPHÉE

LUSTRE
MORPHÉE 9L SN S100

G9 9x 5W LED maxi

Ø 85 cm



47 cm



Finitions



BICOLORE disponible
voir détails p160
NIOBÉ & LÉTO

Verreries



Compléments





NIOBÉ 3

NIOBÉ

LUSTRE
NIOBÉ 3L BR L600 AMBRE
G9 3x 5W LED maxi

Ø 42 cm



LÉTO

LUSTRE
LÉTO 3L BR/SG OP10
G9 3x 5W LED maxi

Ø 42 cm



Livré : 90cm
Mini : 58 cm



Finitions



BICOLORE disponible
voir détails p160

Verreries



Compléments



NIOBÉ



LUSTRE
NIOBÉ 6L SN S100
G9 6x 5W LED W maxi

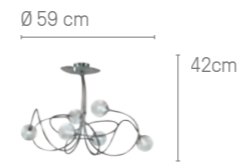

LUSTRE
LÉTO 6L BR L600 CLAIRE
G9 6x 5W LED maxi



Finitions



BICOLORE disponible
voir détails p160

Verreries



Compléments



NIOBÉ 6



HÉVÉA

HÉVÉA

LUSTRE
HÉVÉA 12L SG S100
G9 12x 5W LED maxi

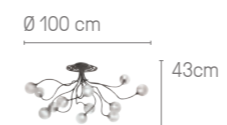

LUSTRE
HÉVÉA 8L BR L600 CLAIRE
G9 8x 5W LED maxi

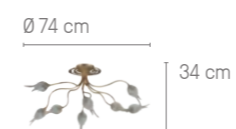

Finitions



Verreries



Compléments





OSIRIS

OSIRIS

LUSTRE
OSIRIS 18L SN S100

G9 18x 5W LED maxi

Ø 136 cm



Livré : 211 cm
Mini : 77 cm



LUSTRE
OSIRIS 12L BR PHYSALIS

G9 12x 5W LED maxi

Ø 111 cm



Livré : 207 cm
Mini : 73 cm



Finitions



BICOLORE disponible
voir détails p160
HEKA

Verreries



Compléments



OSIRIS

LUSTRE
OSIRIS 8L SG OP10

G9 8x 5W LED maxi

Ø 90 cm



Livré : 105 cm
Mini : 55 cm



LUSTRE
OSIRIS 8L BR PHYSALIS

G9 8x 5W LED maxi

Ø 90 cm



Livré : 105 cm
Mini : 55 cm



Finitions



BICOLORE disponible
voir détails p160
OSIRIS & HÉKA

Verreries



Compléments



OSIRIS

LUSTRE
OSIRIS 9L BR S100

G9 9x 5W LED W maxi

Ø 80 cm



50 cm



LUSTRE
OSIRIS 6L SG PHYSALIS

G9 6x 5W LED maxi

Ø 70 cm



41 cm



OSIRIS

LUSTRE
OSIRIS 5L SN MÉTÉORE

G9 5x 5W LED maxi

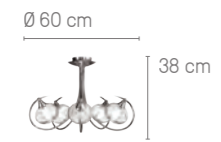

LUSTRE
OSIRIS 3L BR OP10

G9 3x 5W LED maxi



Finitions



BICOLORE disponible
voir détails p160

Verreries



Compléments



OSIRIS

HÉKA

LUSTRE
HÉKA 5L SG S100

G9 5x 5W LED maxi

Ø 60 cm



Livré : 88 cm
Mini : 56 cm



LUSTRE
HÉKA 3L BR/SG S100

G9 3x 5W LED maxi

Ø 46 cm



Livré : 84 cm
Mini : 54 cm



Finitions



BICOLORE disponible
voir détails p160

Verreries



Compléments



P113

HÉKA

LUSTRE
HÉKA 9L BR S100

G9 9x 5W LED maxi

Ø 80 cm



Livré : 169cm
Mini : 69 cm



LUSTRE
HÉKA 6L SN OP10

G9 6x 5W LED maxi

Ø 72 cm



Livré : 90 cm
Mini : 58 cm



SIAM

PLAFONNIER
SIAM 6L SN S100

G9 6x 5W LED maxi

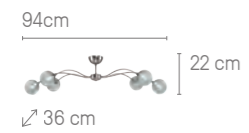

PLAFONNIER
SIAM 6L BR L600 AMBRE

G9 6x 5W LED maxi



Finitions



BICOLORE disponible
voir détails p160
SIAM

Verreries

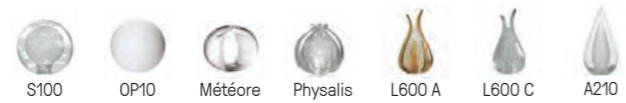

SABIA

LUSTRE
SABIA 10L BR L600 CLAIRE

G9 10x 5W LED maxi

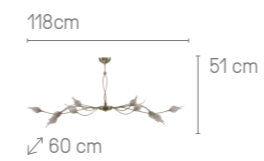

LUSTRE
SABIA 10L BR/SG OP10

G9 10x 5W LED maxi

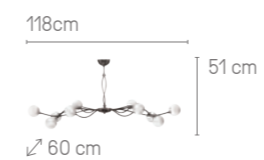

SYRA

LUSTRE
SYRA 6L SG OP10
G9 6x 5W LED maxi

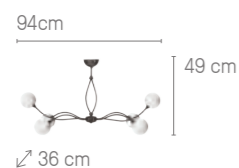

SENJA

PLAFONNIER
SENJA 10L BR L600 CLAIRE
G9 10x 5W LED maxi

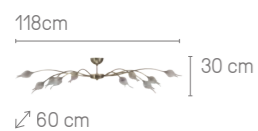

Finitions



BICOLORE disponible
voir détails p160
SIAM

Verreries

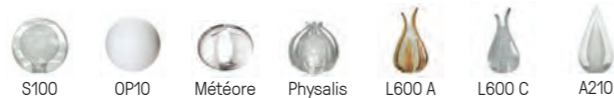



MUMBAI

POONA



LUSTRE
POONA 6L BR A210
G9 6x 5W LED maxi



LUSTRE
BOMBAY 6L SN S100
G9 6x 5W LED maxi



BOMBAY



MUMBAI



LUSTRE
MUMBAI 6L BR/SG OP10
G9 6x 5W LED maxi

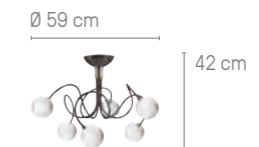

Finitions



BICOLORE disponible
voir détails p160

Verreries

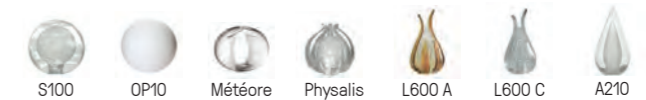

Compléments



MAORI

LUSTRE
MAORI 5L SN OP10

G9 5x 5W LED maxi

Ø 70 cm



Livré : 78 cm
Mini : 46 cm



LUSTRE
MAORI 3L SG/BR S100

G9 3x 5W LED maxi

Ø 60cm



Livré : 71 cm
Mini : 41 cm



Finitions



BICOLORE disponible
voir détails p160

Verreries



MAORI 6L

MAORI

LUSTRE
MAORI 6L BR S100

G9 6x 5W LED maxi

Ø 82 cm



ORIYA

LUSTRE
ORIYA 3L SN OP10

G9 3x 5W LED maxi

Ø 60 cm



ORIYA

LUSTRE
ORIYA 6L SG PHYSALIS

G9 6x 5W LED maxi

Ø 82 cm



LUSTRE
ORIYA 5L BR S100

G9 5x 5W LED maxi

Ø 70 cm



Finitions



BICOLORE disponible
voir détails p160

Verreries





GAÏA

GAÏA

PLAFONNIER
GAÏA 9L SN S100
G9 9x 5W LED maxi



PLAFONNIER
GAÏA 6L BR S100
G9 6x 5W LED maxi



Finitions



Verreries

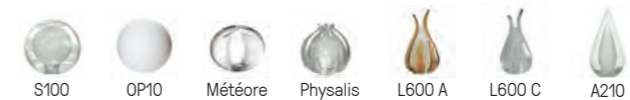

POMPÉI



PLAFONNIER
POMPÉI 3L BR L600 AMBRE
G9 3x4 5W LED maxi

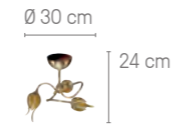

PLAFONNIER
POMPÉI 3L SG OP10
G9 3x 5W LED maxi



PLAFONNIER
POMPÉI 5L BR/SG S100
G9 5x 5W LED maxi



Finitions



BICOLORE disponible
voir détails p160

Verreries

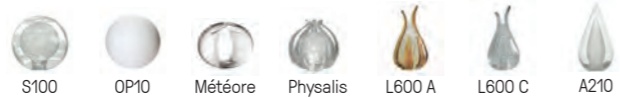



VESUVE

VESUVE

PLAFONNIER
VESUVE 3L SG PHYSALIS
G9 3x 5W LED maxi



PLAFONNIER
VESUVE 3L SN S100
G9 3x 5W LED maxi



PRAGUE

PLAFONNIER
PRAGUE 6L SG OP10
G9 6x 5W LED maxi

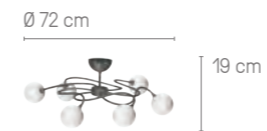

Finitions



BICOLORE disponible
voir détails p160
POMPEI

Verreries





LAIKA

LUSTRE
LAIKA 18L SG MÉTÉORE

G9 18x 5W LED maxi

Ø 100 cm

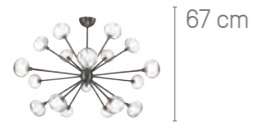

Finitions



Verreries



LAIKA

LUSTRE
LAIKA 12L SN OP10

G9 12x 5W LED maxi

Ø 67 cm

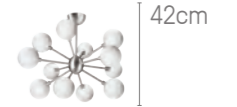

LUSTRE
LAIKA 15L SB MÉTÉORE

G9 15x 5W LED maxi

Ø 82 cm





LUNA

LUNA

LUSTRE
LUNA 6L SG MÉTÉORE

G9 6x 5W LED maxi

Ø 28 cm



LUSTRE
LUNA 8L BR MÉTÉORE

G9 8x 5W LED maxi

Ø 40 cm



Finitions



Verreries



LUNA

LUSTRE
LUNA 12L SN OP10

G9 12x 5W LED maxi

Ø 62 cm



Livré : 103 cm
Mini : 53 cm



LUSTRE
LUNA 16L SG MÉTÉORE

G9 16x 5W LED maxi

Ø 76 cm



Livré : 108 cm
Mini : 58 cm



Finitions



Verreries



LUNA

PERLA

LUSTRE
PERLA 6L BR MÉTÉORE

G9 6x 5W LED maxi

Ø 28 cm



LUSTRE
PERLA 8L SN MÉTÉORE

G9 8x 5W LED maxi

Ø 40 cm



Finitions



Verreries



PERLA

LUSTRE
PERLA 12L SG OP10

G9 12x 5W LED maxi

Ø 62 cm



LUSTRE
PERLA 16L SN MÉTÉORE

G9 16x 5W LED maxi

Ø 76 cm





HALO



SUSPENSION HALO SB
présenté avec 310 ETHNIC SG
E27 1x 8W LED max non fournie

Ø 31 cm
Livrée : 185 cm
Mini : 36 cm



PLAFONNIER HALO R3 rond SG
présenté avec 2 x 225 RAY SN
1 x 225 IDEAL SN

E27 3x 8W LED max non fournie

Ø 50 cm
Livrée : 177 cm
Mini : 28 cm

PLAFONNIER HALO L3 long SG
présenté avec 1 x 310 IDEAL SB
1 x 310 DELTA SB
1 x 310 RAY SB

E27 3x 8W LED max non fournie

120 cm
Livré : 185 cm
Mini : 36 cm

Finitions



HALO



PLAFONNIER HALO R5 rond SB
présenté avec 2 x 225 ECHO SB
2 x 280 ECHO SB
1 x 225 IDEAL SB

E27 5x 8W LED max non fournie

Ø 50 cm
Livré : 177 cm
Mini : 28 cm

PLAFONNIER HALO L5 long SN
présenté avec 1 x 280 DELTA SN
1 x 225 RAY SN
1 x 280 IDEAL SN
1 x 225 DELTA SN
1 x 280 RAY SN

E27 5x 8W LED max non fournie

110 cm
Livré : 185 cm
Mini : 36 cm



HALO À COMPOSER

À la commande, il est important de préciser les finitions de la monture (pavillon + cache-douille) ET de la plaque.

Livré avec du câble tissu noir de 1m50 réglable à l'installation.

Ampoules E27 non fournies.

LES MONTURES

Le pavillon est toujours assorti au cache-douille



SUSPENSION HALO



PLAFONNIER HALO R3



PLAFONNIER HALO R5

Disponible uniquement avec les plaques 225 et 280.

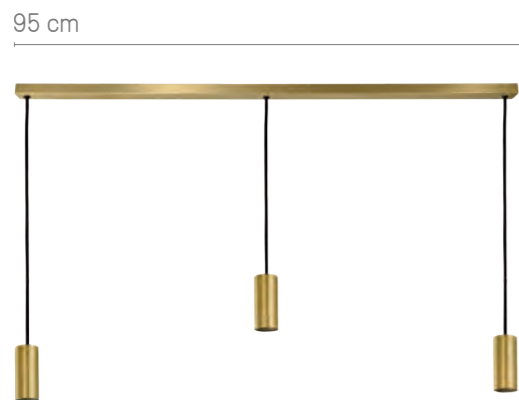

PLAFONNIER HALO L3



PLAFONNIER HALO L5

Disponible uniquement avec les plaques 225 et 280.

Finitions



HALO

LES PLAQUES

PLAQUE 225

Ampoule E27: Globe Ø95 non fournie



PLAQUE 280

Ampoule E27: Edison ST64 non fournie



PLAQUE 310

Ampoule E27: Globe Ø125 non fournie



225 IDEAL



225 RAY



225 DELTA



225 ECHO



225 BULLE



280 IDEAL



280 RAY



280 DELTA



280 ECHO



310 IDEAL



310 RAY



310 DELTA



310 ETHNIC

LES APPLIQUES



DOTS B



DOTS G

DOTS

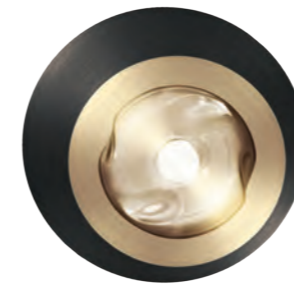

APPLIQUE
DOTS E SB/SG MÉTÉORE

G9 1x 5W LED max

20 cm

20 cm

∅12 cm

APPLIQUE
DOTS F SC/SG MÉTÉORE

G9 1x 5W LED max

24 cm

24 cm

∅12 cm

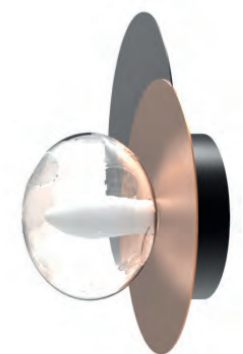
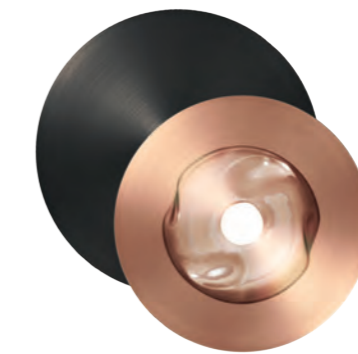

APPLIQUE
DOTS G SB/SG MÉTÉORE

G9 2x 5W LED max

45 cm

27 cm

∅12 cm



Finitions



Verreries



DOTS

APPLIQUE
DOTS A SB/SG MÉTÉORE

G9 3x 5W LED max



APPLIQUE
DOTS B SB/SC MÉTÉORE

G9 5x 5W LED max

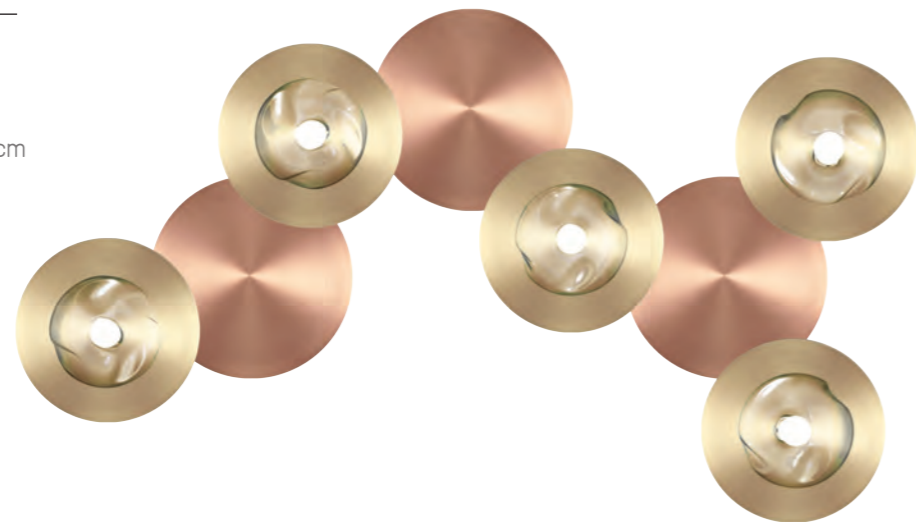
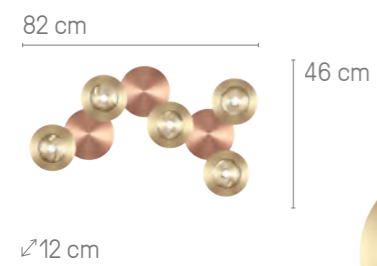

Finitions



Verreries



DOTS

APPLIQUE
DOTS C SN/SG MÉTÉORE

G9 5x 5W LED max

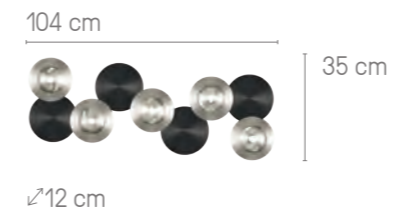

APPLIQUE
DOTS D SB/SG MÉTÉORE

G9 6x 5W LED max



DOTS

CHOISIR SES FINITIONS:

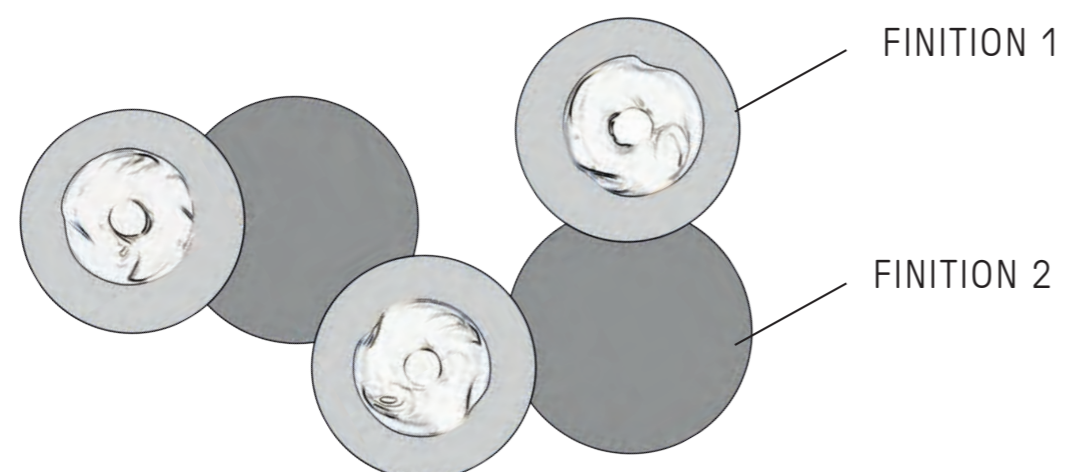

FINITION 1 / FINITION 2



EXEMPLES DE FINITIONS:



SB / SC



SC / SG



SB / SG



SB / SN



SN / SG



RUCHE

RUCHE

APPLIQUE
RUCHE 1L SB

LED intégrée dimmable
2700 °K 900 lm 8W



RUCHE

APPLIQUE
RUCHE 3L SN

LED intégrée dimmable
2700°K 2700 lm 25W

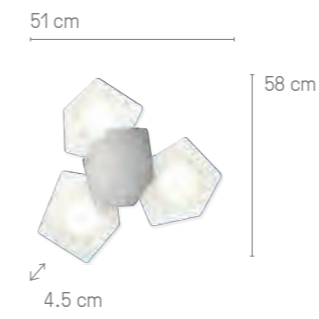

APPLIQUE
RUCHE 2L SG

LED intégrée dimmable
2700 °K 1800 lm 15W

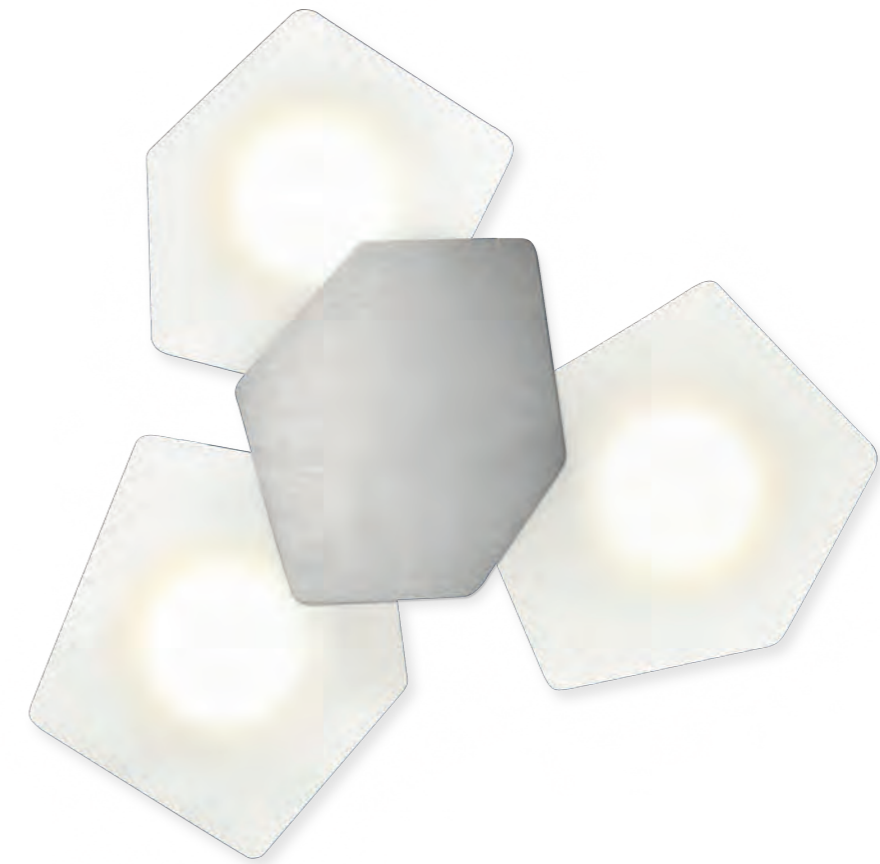

Finitions



NECTAR

APPLIQUE
NECTAR 1L SG

LED intégrée dimmable
2700 °K 900 lm 8W



APPLIQUE
NECTAR 2L SB

LED intégrée dimmable
2700 °K 1800 lm 15W

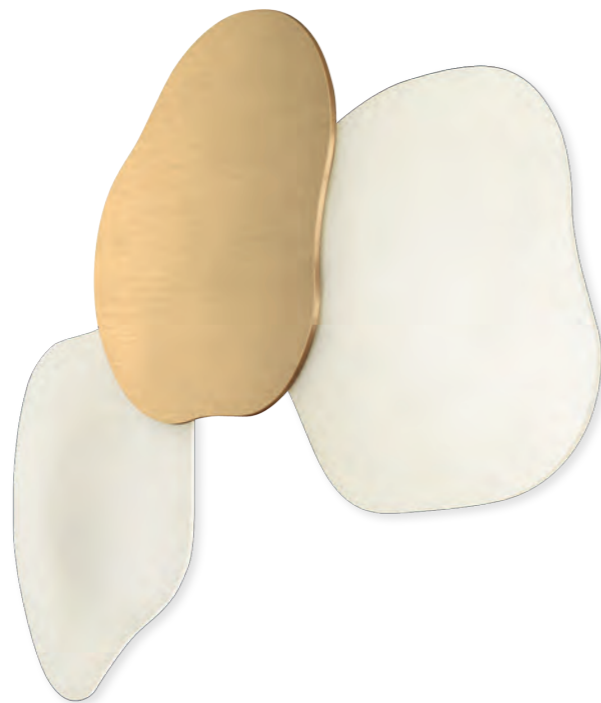
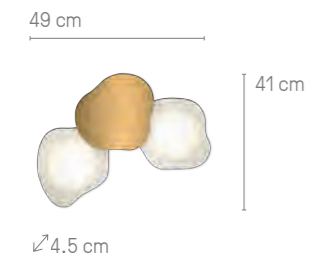

Finitions



NECTAR

APPLIQUE
NECTAR 3L SN

LED intégrée dimmable
2700°K 2700 lm 25W

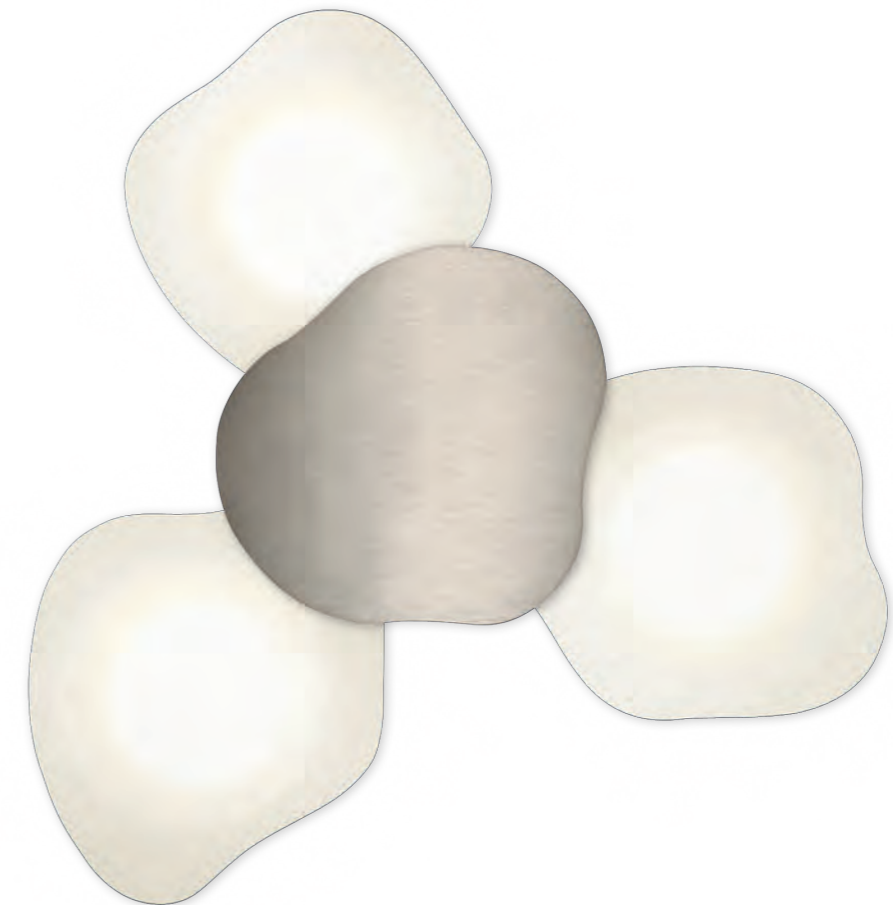
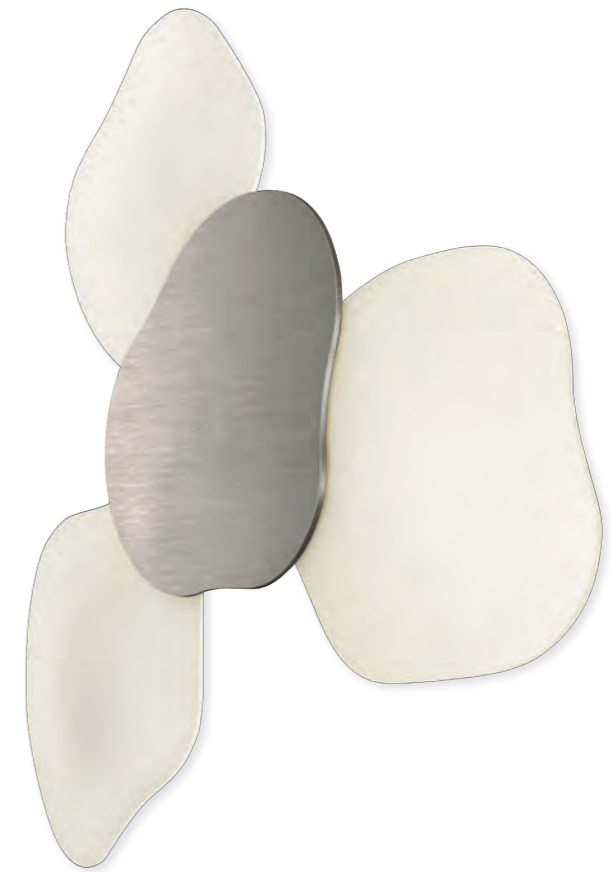
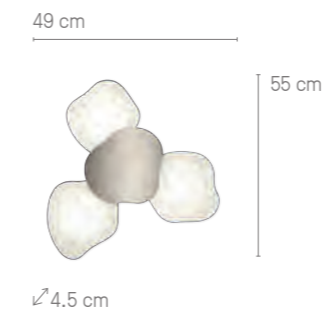



DIAPASON



APPLIQUE
DIAPASON GAUCHE 3L SG/SB OP10
G9 3x 5W LED maxi

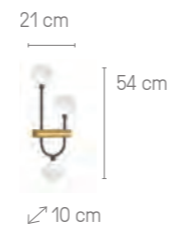

Finitions



BICOLORE disponible
voir détails p158



APPLIQUE
DIAPASON DROITE 3L SB DE09
G9 3x 5W LED maxi



Verreries



APPLIQUE
DIAPASON 3L GAUCHE SN/SG DE09
G9 3x 5W LED maxi



Compléments



WOOL

APPLIQUE
WOOL 2L SB /SG DE07/09

G9 2x 4W LED maxi

10 cm



12 cm

APPLIQUE
WOOL 2L SB DE07/09

G9 2x 4W LED maxi

10 cm



12 cm

APPLIQUE
WOOL 2L SG DE07/09

G9 2x 4W LED maxi

10 cm



12 cm

Finitions



BICOLORE
disponible
voir détails p158

Verreries



INFORMATIONS IMPORTANTES !

Dimensions ampoules G9 LED à respecter :
Hauteur maximum : 53 mm
Diamètre maximum : 18 mm

Compléments



WOOL



NATA



APPLIQUE
NATA 1L BR/SG TU10 OP

G9 5W LED max



APPLIQUE
NATA 1L SN TU12 CLAIRE

G9 5W LED max

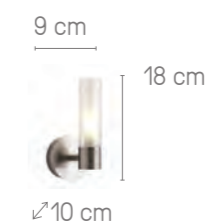

APPLIQUE
NATA 2L SG TU10 OP

G9 2x 5W LED max

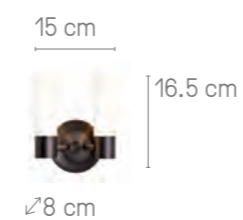

Finitions



BICOLORE
disponible
voir détails p158

Verreries



Compléments



NATA

GÉNÉSIS

SPARTE



APPLIQUE
GÉNÉSIS 2L SN DE09
G9 2x 5W LED maxi



APPLIQUE
GÉNÉSIS 2L SG S100
G9 2x 5W LED maxi

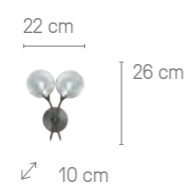

APPLIQUE
GÉNÉSIS 2L BR A210
G9 2x 5W LED maxi

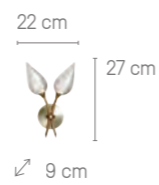

APPLIQUE
SPARTE 3L BR L600 AMBRE
G9 3x 5W LED maxi



APPLIQUE
SPARTE 3L SG A210
G9 3x 5W LED maxi

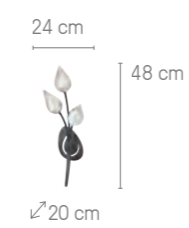

APPLIQUE
SPARTE 3L SN S100
G9 3x 5W LED maxi



Finitions



Verreries



Finitions



Verreries

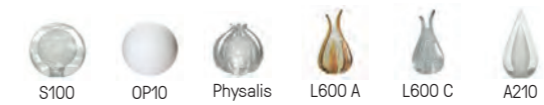

Compléments





PRIAM



APPLIQUE
PRIAM 1L DROITE BR S100
G9 1x 5W LED maxi



APPLIQUE
PRIAM 2L DROITE SG A210
G9 2x 5W LED maxi



APPLIQUE
PRIAM 1L GAUCHE SN OP10
G9 1x 5W LED maxi



APPLIQUE
PRIAM 2L GAUCHE BR L600 AMBRE
G9 2x 5W LED maxi

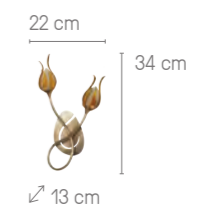

Finitions

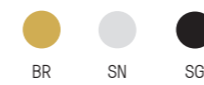

Verreries



Compléments



PRIAM

ILIADE



APPLIQUE
ILIADE 1L SN OP10
G9 1x 5W LED maxi



Finitions



APPLIQUE
ILIADE 1L BR S100
G9 1x 5W LED maxi



Verreries

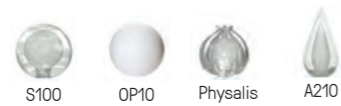

APPLIQUE
ILIADE 1L SG A210
G9 1x 5W LED maxi



OSIRIS



APPLIQUE
OSIRIS 1L BR OP10
G9 1x 5W LED maxi



Finitions

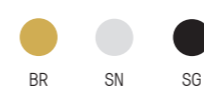

BICOLORE disponible
voir détails p160



APPLIQUE
OSIRIS 1L SG PHYSALIS
G9 1x 5W LED maxi

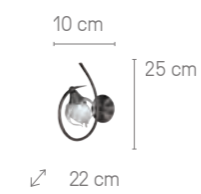

Verreries



APPLIQUE
OSIRIS 1L SN S100
G9 1x 5W LED maxi

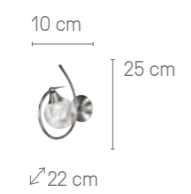

Compléments



LES LAMPES



WOOL



LAMPE
WOOL 2L SG S100

G9 2 x 4W LED maxi

17 cm



13 cm



LAMPE
WOOL 2L SB/SG OP08/10

G9 2 x 4W LED maxi

17 cm



13 cm

WOOL



LAMPE
WOOL 2L SN/SG DE07/09

G9 2 x 4W LED maxi

17 cm



13 cm



LAMPE
WOOL 2L SB DE07/09

G9 2 x 4W LED maxi

17 cm



13 cm

Finitions



BICOLORE
disponible
voir détails p158

Verreries



INFORMATIONS IMPORTANTES !

Dimensions ampoules G9 LED à respecter :
Hauteur maximum : 53 mm
Diamètre maximum : 18 mm

Compléments





TESS

TESS



LAMPE
TESS 3L SG TU10 OPALE
G9 3x 5W LED maxi

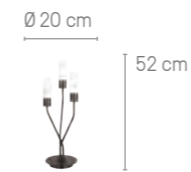

LAMPE
TESS 3L SN TU12 CLAIRE
G9 3x 5W LED maxi

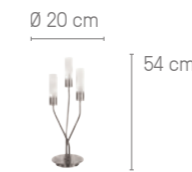

LAMPE
TESS 3L BR/SG TU10 OPALE
G9 3x 5W LED maxi



Finitions



BICOLORE disponible
voir détails p158

Verreries



Compléments

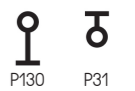

HADES



LAMPE
HADES 3L SG L600 CLAIRE
G9 3x 5W LED maxi



LAMPE
HADES 3L SN S100
G9 3x 5W LED maxi



LAMPE
HADES 3L BR L600 AMBRE
G9 3x 5W LED maxi



Finitions



Verreries



Compléments



HADES

NYMPHÉA



LAMPE
NYMPHÉA 20 1L SN
E27 1x 15W LED maxi

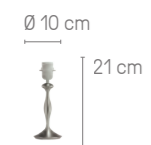

LAMPE
NYMPHÉA 30 1L SG
E27 1x 15W LED maxi

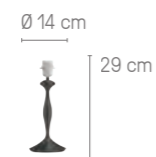

LAMPE
NYMPHÉA 30 1L BR
E27 1x 15W LED maxi

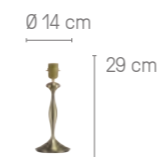

Finitions



TALISMAN



LAMPE
TALISMAN 30 1L SN
E27 1x 15W LED maxi

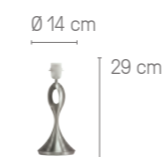

LAMPE
TALISMAN 20 1L BR
E27 1x 15W LED maxi



LAMPE
TALISMAN 20 1L SG
E27 1x 15W LED maxi



Finitions



LES LAMPADAIRES



PAOLA



LAMPADAIRE
PAOLA 5L BR L600 AMBRE

G9 5x 5W LED maxi
Variable



LAMPADAIRE
PAOLA 5L SG S100

G9 5x 5W LED maxi
Variable

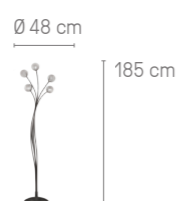

LAMPADAIRE
PAOLA 5L SN L600 CLAIRE

G9 5x 5W LED maxi
Variable

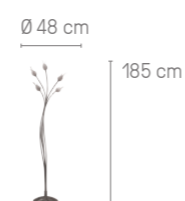

Finitions



Verreries



Compléments



SAKURA



LAMPADAIRE
SAKURA 5L SG S100

G9 5x 5W LED maxi
Variable

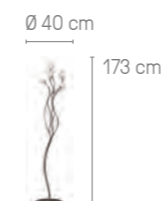

LAMPADAIRE
SAKURA 5L SN OP10

G9 5x 5W LED maxi
Variable

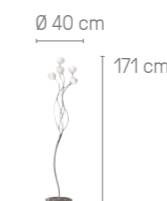

LAMPADAIRE
SAKURA 5L BR A210

G9 5x 5W LED maxi
Variable



Finitions

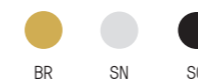

Verreries



Compléments





CIRCÉ

CIRCÉ



LAMPADAIRE
CIRCÉ 5L BR L600 AMBRE

G9 5x 5W LED maxi
Variable

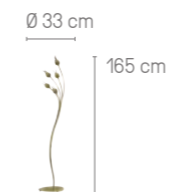

LAMPADAIRE
CIRCÉ 5L SG S100

G9 5x 5W LED maxi
Variable

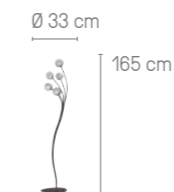

LAMPADAIRE
CIRCÉ 5L SN L600 CLAIRE

G9 5x 5W LED maxi
Variable

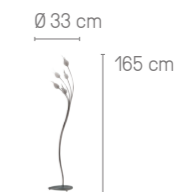

Finitions



Verreries

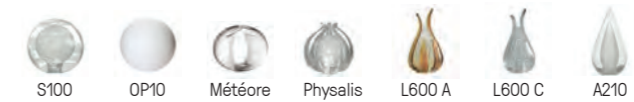

Compléments





TESS

TESS



LAMPADAIRE
TESS 5L SG TU10 OPALE
G9 5x 5W LED maxi
Variable

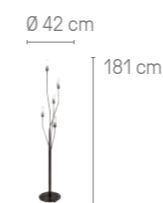

Finitions



LAMPADAIRE
TESS 5L SN TU12 CLAIRE
G9 5x 5W LED maxi
Variable

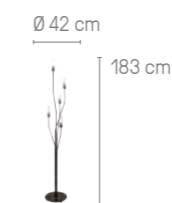

Verreries



LAMPADAIRE
TESS 5L BR/SG TU10 OPALE
G9 5x 5W LED maxi
Variable

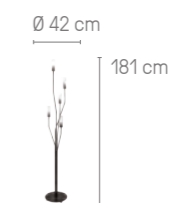

Compléments



LES RÉFLECTEURS TABLEAUX



GAMME 5000

RÉFLECTEUR TABLEAUX 5002 SG

Tube E14 2x 5W LED max
Réflecteur pivotant à 90°



RÉFLECTEUR TABLEAUX 5004 SN

Tube E14 4x 5W LED max
Réflecteur pivotant à 90°

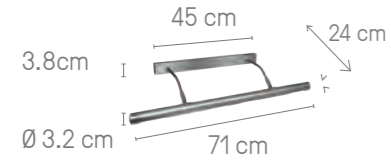

RÉFLECTEUR TABLEAUX 5006 BR

Tube E14 6x 5W LED max
Réflecteur pivotant à 90°

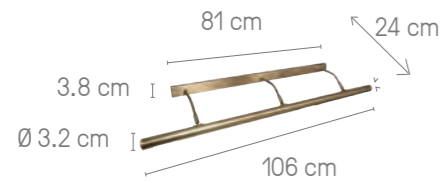

Finitions



GAMME 5000

RÉFLECTEUR TABLEAUX 5012 SN

Tube E14 2x 5W LED max
Réflecteur pivotant à 90°

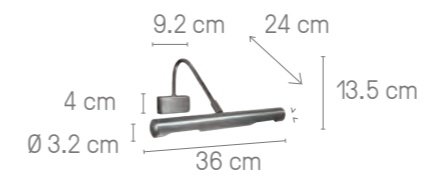

RÉFLECTEUR TABLEAUX 5014 BR

Tube E14 4x 5W LED max
Réflecteur pivotant à 90°

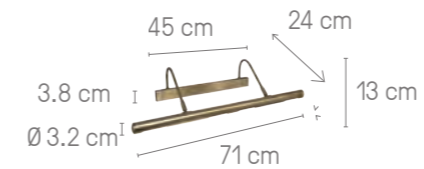

RÉFLECTEUR TABLEAUX 5016 SG

Tube E14 6x 5W LED max
Réflecteur pivotant à 90°

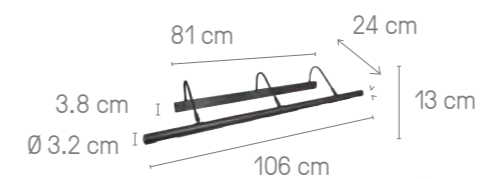



GAMME 9000



RÉFLECTEUR TABLEAUX
9002 SG
G9 2x 4W LED max
Réflecteur pivotant à 360°

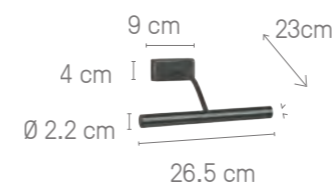

RÉFLECTEUR TABLEAUX
9012 BR
G9 2x 4W LED max
Réflecteur pivotant à 360°

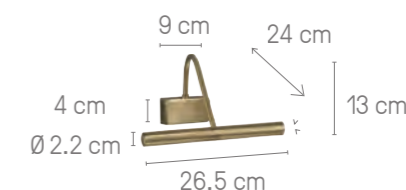

RÉFLECTEUR TABLEAUX
9004 BR
G9 4x 4W LED max
Réflecteur pivotant à 360°

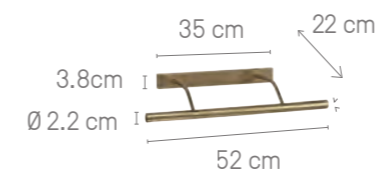

RÉFLECTEUR TABLEAUX
9006 SN
G9 6x 4W LED max
Réflecteur pivotant à 360°

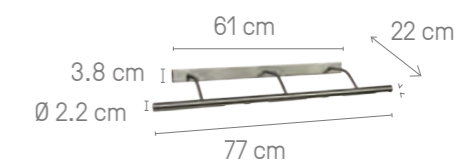

Finitions



GAMME 6000



RÉFLECTEUR TABLEAUX
6020 SN

Tube E14 1x 5W LED max
Réflecteur pivotant à 90°

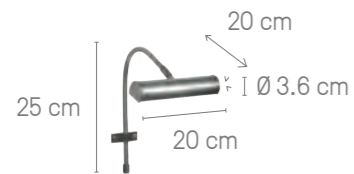

RÉFLECTEUR TABLEAUX
6036 BR

Tube E14 2x 5W LED max
Réflecteur pivotant à 90°

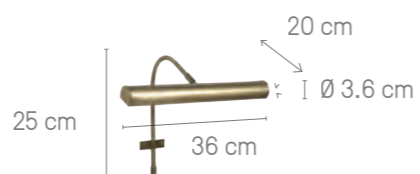

RÉFLECTEUR TABLEAUX
6050 SG

Tube E14 2x 5W LED max
Réflecteur pivotant à 90°

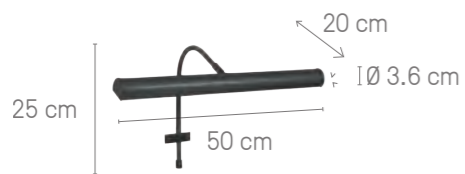

RÉFLECTEUR TABLEAUX
6080 BR

Tube E14 4x 5W LED max
Réflecteur pivotant à 90°

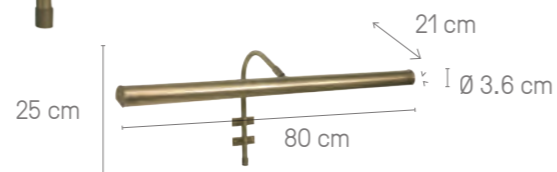
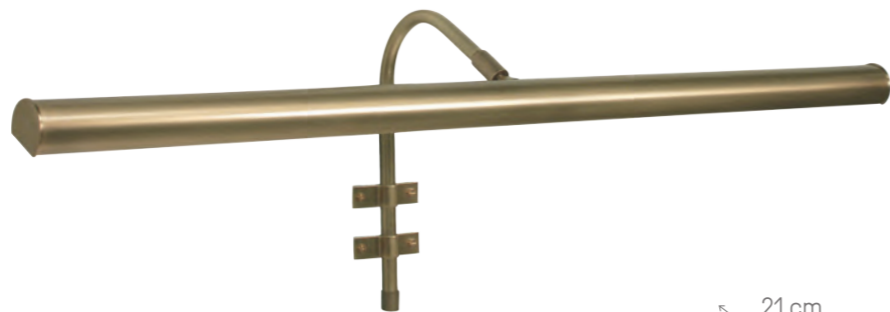

Finitions



6036

LA GAMME CLASSIQUE



CHÂTELET

APPLIQUE
CHÂTELET 1L SG
E14 1x 8W LED max

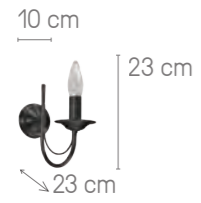

APPLIQUE
CHÂTELET 2L BR
E14 2x 8W LED max

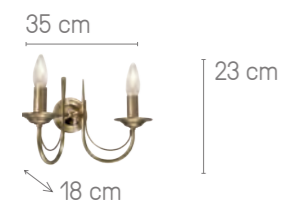

Finitions



BICOLORE
disponible
voir détails p160

AMPOULES FLAMMES E14 NON FOURNIES

CHÂTELET

LUSTRE
CHÂTELET 3L BR
E14 3x 8W LED max

Ø 46 cm



Livré : 78 cm
Mini : 46 cm



LUSTRE
CHÂTELET 5L SN
E14 5x 8W LED max

Ø 58 cm



Livré : 83 cm
Mini : 51 cm



Finitions

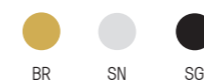

BICOLORE
disponible
voir détails p160

AMPOULES FLAMMES E14 NON FOURNIES

CHÂTELET

LUSTRE CHÂTELET 6L BR/SG

E14 6x 8W LED max

Ø 70 cm



Livré : 85 cm
Mini : 53 cm



LUSTRE CHÂTELET 9L SG

E14 9x 8W LED max

Ø 92 cm



Livré : 163 cm
Mini : 68 cm

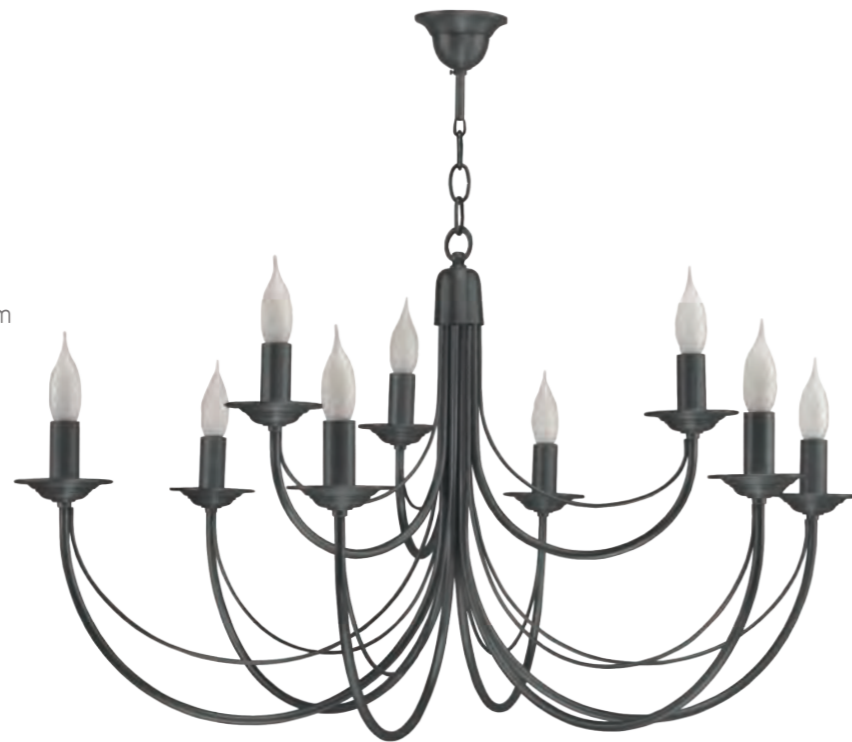

Finitions



BICOLORE
disponible
voir détails p160

AMPOULES FLAMMES E14 NON FOURNIES

CHÂTELET

LUSTRE CHÂTELET 12L BR

E14 12x 8W LED max

Ø 94 cm



Livré : 184cm
Mini : 87 cm



LUSTRE CHÂTELET 18L SN

E14 18x 8W LED max

Ø 119 cm



Livré : 184 cm
Mini : 87 cm



LA GAMME BILLARD



CREIL

LUSTRE
CREIL 2L BR 3926 PÊCHE

Tube E27 2x 15W LED maxi



LUSTRE
CREIL 3L BR 3626 OPALE

Tube E27 3x 15W LED maxi



Finitions



Compléments



P152

KIMI

LUSTRE
KIMI 2L SN 3926 OPALE

E27 2x 15W LED maxi



LUSTRE
KIMI 3L SG 3926 OPALE

E27 3x 15W LED maxi

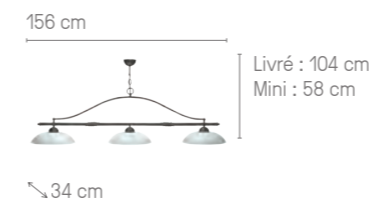

KOLOA

LUSTRE
KOLOA 2L SG 3926 OPALE

E27 2x 15W LED maxi

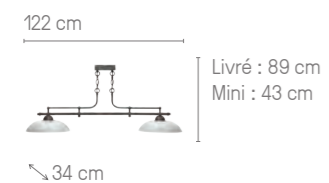

LUSTRE
KOLOA 3L SN 3926 OPALE

E27 3x 15W LED maxi

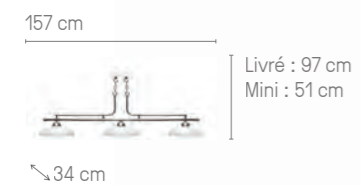

Finitions



Compléments



P152

ÉRAGNY

LUSTRE
ÉRAGNY 2L BR 3926 PÊCHE

E27 2x 15W LED maxi



LUSTRE
ÉRAGNY 3L BR 3926 OPALE

E27 3x 15W LED maxi



MAYENNE



APPLIQUE
MAYENNE 1L BR 5160 OPALE
E27 1x 15W LED maxi



APPLIQUE
MAYENNE 1L BR 3926 PÊCHE
E27 1x 15W LED maxi



GOUDET



SUSPENSION
GOUDET 1L SG 5160 OPALE
E27 1x 15W LED maxi



SUSPENSION
GOUDET 1L SN 3926 OPALE
E27 1x 15W LED maxi

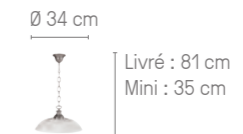

NEPTUNE



APPLIQUE
NEPTUNE 1L SN 5160 OPALE
E27 1x 15W LED maxi



APPLIQUE
NEPTUNE 1L SN 3926 OPALE
E27 1x 15W LED maxi



SUSPENSION
GOUDET 1L BR 3926 PÊCHE
E27 1x 15W LED maxi



SUSPENSION
GOUDET 1L BR 3926 OPALE
E27 1x 15W LED maxi

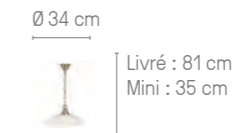

Finitions



Compléments



Finitions



GUERANDE



PLAFONNIER
GUERANDE 1L BR 5160 PÊCHE
E27 1x 15W LED maxi



PLAFONNIER
GUERANDE 1L SG 5160 OPALE
E27 1x 15W LED maxi

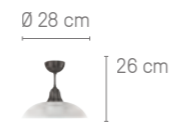

LISIEUX



PLAFONNIER
LISIEUX 1L BR 5160 PÊCHE
E27 2x 15W LED maxi

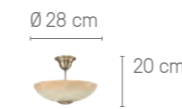

PLAFONNIER
LISIEUX 1L BR 3926 OPALE
E27 2x 15W LED maxi



PLAFONNIER
GUERANDE 1L SN 3926 OPALE
E27 1x 15W LED maxi

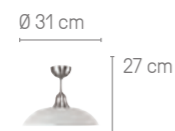

Finitions



Compléments



MERCURE



PLAFONNIER
MERCURE 1L SN 5160 OPALE
E27 2x 15W LED maxi

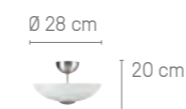

PLAFONNIER
MERCURE 1L SN 3926 OPALE
E27 2x 15W LED maxi

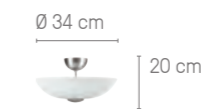

LES VERRERIES



5160 OPALE
Ø : 28.5 cm



5160 PÊCHE
Ø : 28.5 cm

H : 7.5 cm



3926 OPALE
Ø : 34 cm



3926 PÊCHE
Ø : 34 cm

H : 8.5 cm



3945 OPALE
Ø : 43 cm



3945 PÊCHE
Ø : 43 cm

H : 9.5 cm

LES VERRERIES G9



L600 AMBRE
Ø : 5 cm
H : 11 cm



L600 CLAIRE
Ø : 5 cm
H : 11 cm



A210
Ø : 12.5 cm
H : 6.5 cm



PHYSALIS
Ø : 9 cm

LES VERRERIES G9



S100
Ø : 10 cm



MÉTÉORE
Ø : 11 cm
H : 8 cm



OP08
Ø : 8 cm



OP10
Ø : 10 cm



OP12
Ø : 12 cm



DE07
Ø : 7 cm



DE09
Ø : 9 cm



DE12
Ø : 12 cm



TU10 OPALE
Ø : 3 cm
H : 10 cm



TU 12 CLAIRE
Ø : 3 cm
H : 12 cm

CHOISIR SES FINITIONS BICOLORES

FINITIONS 1 et 2

à choisir parmi les finitions proposées pour chaque produit.

EXEMPLE:



FINITION ① = Zones en noir

FINITION ② = Zones en gris

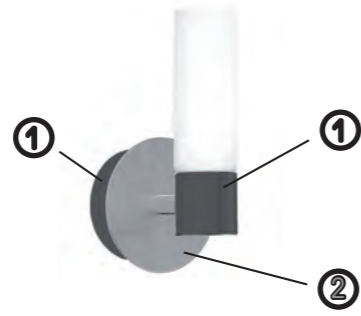

NATA 1L F①/F②



NATA 1L BR/SG

DIAPASON

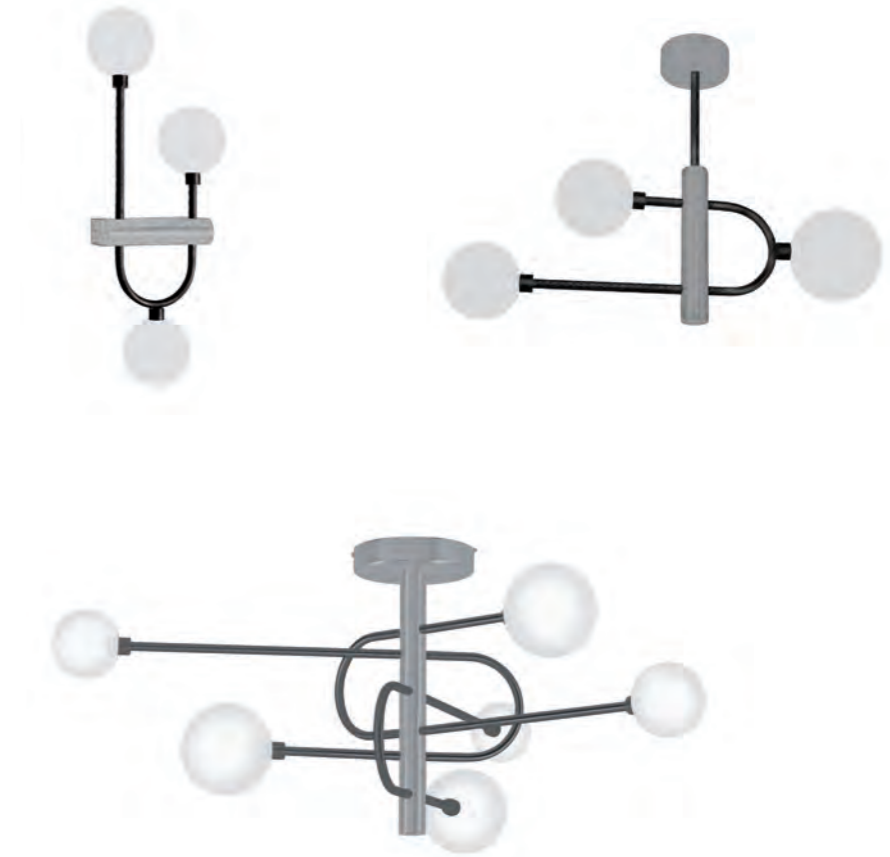

WOOL



NATA



GLOBULE



TESS



CHOISIR SES FINITIONS BICOLORES

FINITION ① = Zones en noir

FINITION ② = Zones en gris

CHÂTELET



LÉTO NIOBÉ



POMPEI



SIAM



BOMBAY MUMBAI



MAORI ORIYA



OSIRIS







C·V·L
MANUFACTURE

Réalisation, textes et photos produits: CVL

Photos produits pages 15, 21, 27, 104 et 115: Atelier grand angle

Photo Ambiance Applique Diapason : Laure Evrat Photographie

Photos Ambiances: Garnier Studios

3D Ambiances : Cgifurniture

Photos Atelier: Yannick Labrousse

WWW.CVL-MANUFACTURE.FR

79 ROUTE DE LA CHEVALLERIE - 49770 LONGUENÉE-EN-ANJOU - FRANCE

TEL. +33 (0) 2 41 32 67 54

EMAIL : CONTACT@CVL-LUMINAIRES.FR