

BUZZI & BUZZI













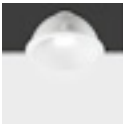

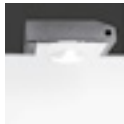



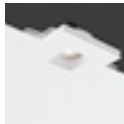













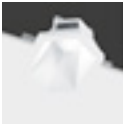





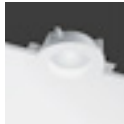

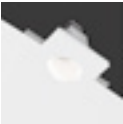

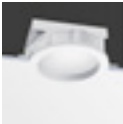





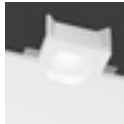

















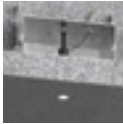

















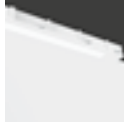



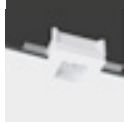

THE LIGHT THAT PURIFIES THE AIR















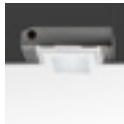







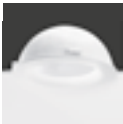
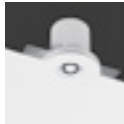























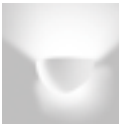





























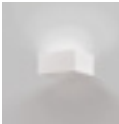







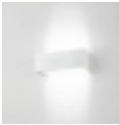

























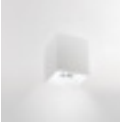



29	RECESSED
289	SURFACE
415	OUTDOOR
493	GENERAL INFORMATION

29 Recessed















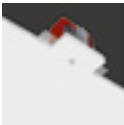







  176 ALKABOX	  230 ARGIA	  142 ATOM	  162 BASIC ROUND	  166 BASIC SQUARE
  116 BELL	  204 BILD	  154 BITRIX	  170 BLACK BOX	  236 BLADE
  108 BULL	  120 BUZZ	  136 CLASS	  132 DRY	  196 ECLA
  126 EGGY	  200 ELIOS	  274 END	  292 FLEXI	  190 FOCUS
  270 GAP	  30 GENIUS	  70 GENIUS BASIC	  74 GENIUS BASIC FLAT	  86 GENIUS BASIC NAKED
  76 GENIUS BASIC SLOPE	  64 GENIUS BLACK	  58 GENIUS BRASS	  88 GENIUS CONCRETE	  66 GENIUS CURVE
  54 GENIUS DIM TO WARM	  50 GENIUS DYNAMIC WHITE	  78 GENIUS NAKED	  42 GENIUS SQUARE	  62 GENIUS SQUARE BRASS
  244 GHOST	  252 GLOBE	  260 INVIDIA	  134 INVISIBLE	  144 INVISILED
  94 INZETA	  150 JACOBBOX	  282 LEAF	  234 LENTIL	  148 LIGHT

 <p>© 214 LYS</p>	 <p>☼ 256 MARKUS</p>	 <p>© 208 MAXI BILD</p>	 <p>© 212 MAXI RIM</p>	 <p>☼ 138 MINI SECRET</p>
 <p>☼ 290 MOTUS</p>	 <p>☼ 286 NASTRO</p>	 <p>☼ 178 NEFI</p>	 <p>☼ 182 NIMBUS</p>	 <p>© 266 NOTHING</p>
 <p>☼ 218 NOVA</p>	 <p>© 242 PHANTOM</p>	 <p>☼ NEW 92 PIXEL</p>	 <p>☼ 226 POLARIS</p>	 <p>© 98 RHINO</p>
 <p>© 210 RIM</p>	 <p>☼ 158 RING</p>	 <p>☼ 112 SLICE</p>	 <p>☼ 248 SPIRIT</p>	 <p>☼ 222 SUPERNOVA</p>
 <p>© 102 TAURUS</p>	 <p>☼ 186 TEKNO</p>	 <p>☼ 156 TETRIS</p>	 <p>☼ 36 TWIN GENIUS</p>	 <p>☼ 84 TWIN GENIUS NAKED</p>
 <p>☼ 46 TWIN GENIUS SQUARE</p>	 <p>☼ 278 UNLEAF</p>	 <p>☼ 172 WHITE BOX</p>	 <p>☼ 192 ZOOM</p>	

295 Surface

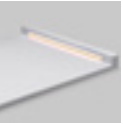
 	  NEW 400	 	 	 
356 ANGOLO	BARD	334 BAUTA ELLISSE	344 BAUTA SFERA	374 CORNICE
 	 	 	 	 
354 CUPOLA	380 DOT	336 ELLISSE	342 ELLISSE BASE	360 FLAG
 	 	 	 	 
362 FRAME	412 FUNNEL LAMP	418 HOLE	416 ITEM ONE	370 LIGHT BOX
 	 	 	 	 
322 LINEA 5	304 MASTER OPEN	328 MAXIMAL	330 MINIMAL	326 MODUS
 	 	 	 	 
302 PIPEDINO DIRECT	298 PIPEDINO INDIRECT	310 PIPEDINO OPEN	296 PIPEDO	300 PIPEDO DIRECT
 	  NEW	 	 	 
306 PIPEDO OPEN	376 PIXEL C	366 PONTE GRANDE	368 PONTE PICCOLO	346 SFERA
 	 	 	 	  NEW
352 SFERA BASE	350 SFERA S 300	396 SIDUS	386 SKY	392 SLICE C
 	 	 	 	 
390 STAR	404 TELESCOPIC	358 TORCE	332 VERSUS	314 YANG
 	 			
318 YIN	408 ZEN			

421 Outdoor

				
456 ALADIN IP65	450 BLADE IP44/IP65	426 GENIUS BASIC IP65	430 GENIUS BASIC NAKED IP65	422 GENIUS IP65
				
428 GENIUS NAKED IP65	440 IDROROUND IP65	436 IDROUT IP65	432 INVISILED IP44/IP65	DC 464 MINIVIRTUS IP65
				
DC 470 MINIVIRTUS DIRECT IP65	DC 490 MOND IP65	DC 462 NUSS IP65	444 ORIS IP65	DC 458 PASSÉ IP65
				
448 PHANTOM IP44/IP65	DC 490 THE BOLLARD	DC NEW 474 THE NUDE	DC 478 UNDERLINE	DC 482 UNDERScore
				
DC 486 VALO IP65	DC 468 VIRTUS IP65	DC 472 VIRTUS DIRECT IP65		





BUZZI & BUZZI

Buzzi & Buzzi viene fondata nel 1990 da Marialuisa Chiari e Pietro Buzzi, professionisti affermati che decidono di esplicitare e coltivare le intuizioni e le conoscenze maturate in anni di esperienza nel settore illuminotecnico.

Sin dai primi anni l'azienda si avvale della collaborazione di affermati architetti, riconoscendo al design l'importante ruolo di differenziazione.

Tecnica e design si fondono per dare vita a concetti inediti di luce: nascono oggetti in grado di esprimersi in modo realmente diverso, non solo dal punto di vista estetico, ma anche funzionale e tecnico.

Buzzi & Buzzi si è affermata sia in campo nazionale che internazionale; attenta alle richieste e ai linguaggi della contemporaneità, si è specializzata nella proposta di prodotti a scomparsa totale, sfruttando le performance tecniche del Coral®.

Questo excursus fa di Buzzi & Buzzi un'azienda di successo, attenta all'innovazione, allo studio dei materiali e al continuo potenziamento della qualità e del servizio.

L'azienda si è contraddistinta negli anni per un impegno etico fondato sull'attenzione per l'ambiente, espresso innanzitutto per mezzo del Coral® che, andando oltre al concetto di impatto zero, si propone con un ruolo attivo che migliori l'ambiente in cui viene installato; ma anche attraverso la scelta delle sorgenti luminose, costituite principalmente da lampade a risparmio energetico fluorescenti e led, previste per buona parte degli apparecchi prodotti dall'azienda.

Inoltre Buzzi & Buzzi garantisce una costante attenzione al cliente e ai propri dipendenti, tramite la ricerca di un materiale che coniuga le scelte produttive a vantaggio di entrambi.

Buzzi & Buzzi was founded in 1990 by Pietro Buzzi and Marialuisa Chiari, two successful professionals who decided to cultivate and explain the insights and knowledge they had gained from years of experience in the lighting sector.

Since the early years, the company has relied on the contribution of renowned architects, thus recognizing the importance of design differentiation.

Technology and design come together to create new concepts of light: the result is objects which are genuinely different, not only from an aesthetic point of view, but also functional and technical.

Buzzi & Buzzi has established itself both nationally and internationally. Due to its alertness towards requests and modern trends, the company has specialized in proposing total recessed lighting products, while making the most of the Coral®'s technical performance.

The company has distinguished itself over the years through an ethical commitment based on its respect for the environment.

This is reflected not only in the use of Coral®, which goes beyond the concept of zero impact and also plays an active role in improving the environment in the space where it is installed, but also through the choice of light sources which are mainly energy-saving and LED lightbulbs used extensively in Buzzi & Buzzi products.

Moreover, Buzzi & Buzzi guarantees a constant attention to its customers and its employees, through the research of a material that links production with benefits for both of them.





Architecture
is the learned
GAME
& CORRECT
MAGNIFICENT
of forms
assembled in the
LIGHT

Le Corbusier

**1 COLLEZIONE,
3 CATEGORIE,
4 MATERIALI.**

***1 COLLECTION,
3 CATEGORIES,
4 MATERIALS.***

Nuovi prodotti e nuove forme di luce.

Dalla perfetta integrazione tra tecnologia e design, nasce una collezione in grado di esprimersi in modo concretamente diverso, non solo dal punto di vista estetico, ma anche da quello tecnico e funzionale. AirCoral®, DurCoral® e Coral WaterOut®, i materiali esclusivi Buzzi & Buzzi, vivono nei prodotti Recessed, Surface e Outdoor, per una collezione che cambia le regole del semplice illuminare, concretizzando il concetto di “luce architettuale”.

New products and new forms of light.

The perfect integration between technology and design leads to the creation of a line whose ways of expression are concretely different not just in terms of aesthetics, but also for what concerns function and technique. AirCoral®, DurCoral® e Coral WaterOut®, the exclusive Buzzi & Buzzi's materials, live in the Recessed, Surface and Outdoor products for the benefit of a line which revolutionises the rules of traditional illumination, perfectly embodying the concept of “architectural light”.



Recessed

**PRODOTTI TECNICI AD
INCASSO E SEMINCASSO**

*RECESSED AND SEMI-RECESSED
LIGHTING*

Surface

**PRODOTTI
ARCHITECTURAL DESIGN**

*ARCHITECTURAL DESIGN
PRODUCTS*

Outdoor

ELEVATO GRADO IP

HIGH IP PROTECTION



Materials



TECHNIQUE, SILKNESS & ESSENTIAL FORMS



WHAT ABOUT

È un materiale innovativo formato da minerali naturali e da elementi aggreganti che lo rendono estremamente resistente alle temperature elevate ed agli shocks termici, e consentono di ottenere superfici lisce al tatto, ma allo stesso tempo resistenti agli urti e ai graffi.

Is an innovative material made from natural minerals and aggregates that make it extremely resistant to high temperatures and shocks and result in surfaces that are smooth-to-the-touch but at the same time shock and scratch proof.



DECORABILE CON PITTURA
customizzazione

PAINTABLE
customization



ASSENZA DI DILATAZIONE
assenza di crepe nell'installazione

NO EXPANSION
absence of cracks in the installation

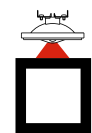

RESISTENZA TERMICA
ampia possibilità di sorgenti luminose

THERMAL RESISTANCE
large choice of light sources



REPELLENTE ALLA POLVERE
non necessita di manutenzione

DUST REPULSIVE
no maintenance necessary



SUPERFICIE SATINATA BIANCA
confortevole al tatto, effetto vellutato

WHITE SATIN SURFACE
touch comfortable, velvet effect



RESISTENTE AI RAGGI UV
inalterabile nel tempo

UV RESISTANT
permanent



BASSISSIMA CONDUCIBILITÀ TERMICA
applicazione in zone accessibili

LOWEST THERMIC CONDUCTIBILITY
application in accessible areas



NON TOSSICO
applicazione in ospedali o in bio-architettura

NOT TOXIC
application in hospitals or in bio-architecture



NON INFIAMMABILITÀ
assenza di fumi tossici

NOT FLAMMABLE
absence of toxic smokes



ANALLERGICO
applicazione in ospedali o in bio-architettura

ANTI-ALLERGIC
application in hospitals or in bio-architecture



RESISTENTE AGLI SHOCK TERMICI
installazione in molteplici condizioni di utilizzo

HIGH RESISTANCE TO TEMPERATURE SHOCKS
installation in multiple purpose conditions



ASSENZA DI REATTIVITÀ CHIMICA
utilizzo in ambienti pubblici (ospedali, spa)

ABSENCE OF CHEMICAL REACTIVITY
use in public surroundings (hospitals, spa)



DUREZZA
elevata durezza all'incisione

HARDNESS
high cut hardness

THE
LIGHT
THAT PURIFIES
THE
AIR

AIRCORAL® PURIFICA L'ARIA PER VIVERE MEGLIO.

AIRCORAL® PURIFIES THE AIR TO IMPROVE THE QUALITY OF LIFE.





MORE THAN CORAL®



ANTIBATTERICO

capacità di eliminazione totale dei batteri dalle superfici

PER CREARE AMBIENTI SALUBRI

AirCoral® è consigliato in tutti quei luoghi pubblici, come ospedali e strutture sanitarie, dove è preponderante la volontà di creare un ambiente salubre.

ANTIBACTERIAL

ability to complete elimination of bacteria from surface

TO CREATE A HEALTHY ENVIRONMENT

AirCoral® is suggested for all those places, such as hospitals and medical structures, where there is an overriding desire to create a healthy environment.



DEGRADO ELEMENTI INQUINANTI

NEGLI AMBIENTI AFFOLLATI

Non tutti sanno che, negli spazi chiusi e affollati, tipici degli ambienti di lavoro, sono spesso presenti il doppio degli agenti inquinanti rispetto all'esterno. I prodotti in AirCoral®, depurando l'aria, provvedono a garantire un contesto ideale anche in presenza di un numero elevato di persone.

DEGRADATION OF POLLUTANTS

IN CROWDED PLACES

In closed and crowded places, such as working environments, there is often a double quantity of polluting agents than outside. AirCoral® products purify the air and grant a healthy context also in presence of a great number of people.

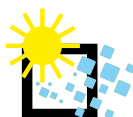

MATERIALE FOTOCATALITICO PER PURIFICARE L'ARIA

BENESSERE NEGLI SPAZI PRIVATI

Le lampade Buzzi & Buzzi realizzate in AirCoral® illuminano, purificano e arredano gli ambienti delle case, permettendo di ridurre l'inquinamento degli spazi in cui abitiamo, eliminando gli agenti inquinanti dannosi per la salute dell'uomo.

PHOTOCATALYTIC MATERIAL TO PURIFY THE AIR

WELLNESS IN PRIVATE SPACES

Buzzi & Buzzi products in AirCoral® light up, purify and decorate the spaces of houses, and reduce the pollution in the spaces where we live by removing the dangerous agents for the human health.

AirCoral®,
l'antibatterico
che purifica l'aria

*AirCoral®,
the antibacterial product
that purifies the air*

AirCoral®, brevettato e certificato dall'ente americano TCNA, Tile Council of North America è un materiale con un potente effetto antibatterico, che ha la capacità di trasformare le sostanze nocive dell'aria in sostanze innocue, con un processo simile alla fotosintesi clorofilliana (fotocatalisi).

AirCoral®, patented and certified by the American authority TCNA, Tile Council of North America, is a material with a powerful antibacterial effect, which is able to transform harmful substances in the air into harmless substances, with a process similar to chlorophyllous photosynthesis (photo catalysis).

Testato da / Tested by



TCNA: Tile Council of North America



University of Manchester

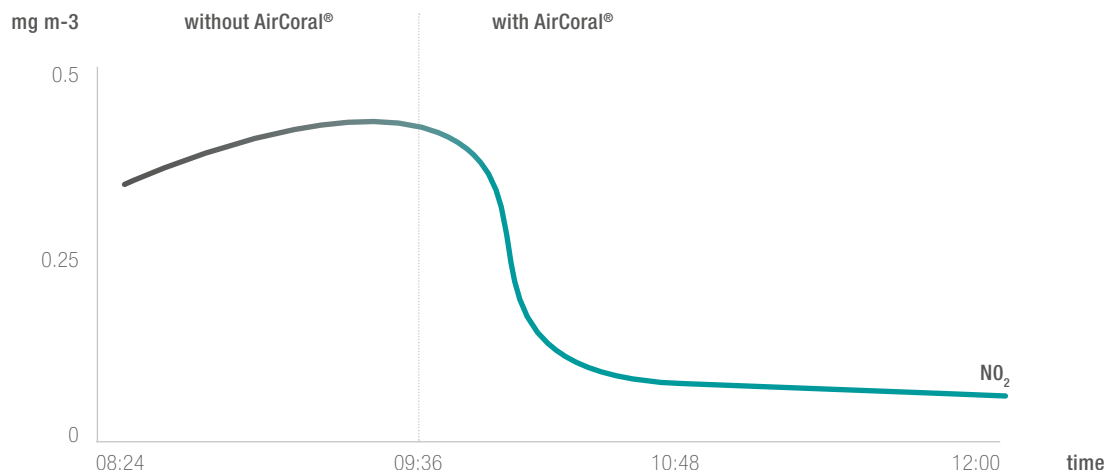

Gli effetti di AirCoral® sono stati validati e misurati dall'Università di Manchester

(November 2017 - School of chemical engineering and analytic Science) che ha evidenziato:

The effects of AirCoral® have been assessed and measured by Manchester University

(November 2017 - School of chemical engineering and analytic Science) which highlighted:

1.

EFFETTO ANTIBATTERICO

AirCoral® è efficace su tutti i batteri con particolare efficacia verso lo **Stafilococco**, la **Pseudomonas aeruginosa** e **Klebsiella Pneumoniae** responsabili di diversi disturbi che colpiscono polmoni e cuore.

ANTIBACTERIAL EFFECT

AirCoral® is effective on all bacteria with particular efficacy on **Staphylococcus**, **Pseudomonas aeruginosa** and **Klebsiella Pneumoniae** responsible for various illnesses involving the lungs and heart.

2.

EFFETTO ANTI-INQUINAMENTO

Le sostanze inquinanti volatili vengono convertite in prodotti innocui, con particolare efficacia verso **anidride carbonica**, **metano**, **ammoniaca** e **metil solfuro**.

ANTI-POLLUTING EFFECT

Volatile polluting substances are converted into harmless products, with particular efficacy towards **carbon dioxide**, **methane**, **ammonia** and **methyl sulphide**.

3.

EFFETTO PURIFICANTE

La capacità di **ridurre** sensibilmente la presenza di **metalli nell'aria**, con maggiore effetto verso il **cadmio** e il **piombo**, metalli pesanti responsabili di gravi problemi alla salute.

PURIFYING EFFECT

The capacity to considerably **reduce** the presence of **metals in the air**, with greater effect on **cadmium** and **lead**, metals responsible for serious health problems.



Puoi calcolare le capacità di AirCoral® con un apposito calcolatore: seleziona i prodotti, inseriscine la quantità e conoscerai così il totale di aria purificata.

You can calculate AirCoral®'s capacity with a special calculator: select the products, enter their quantity and find out the total amount of purified air.

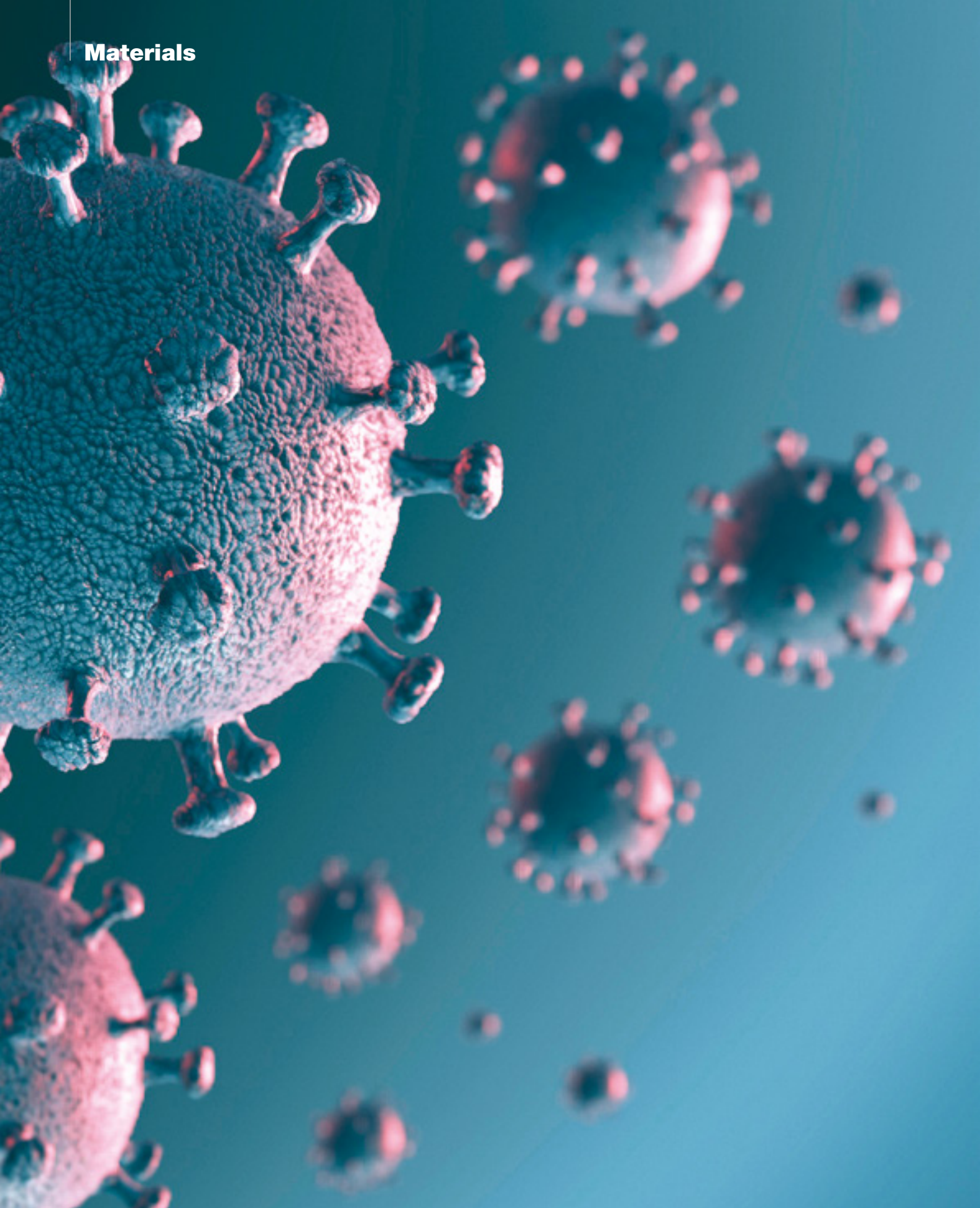

AirCoral[®] trasforma in innocue
le sostanze nocive presenti
nell'aria.

GRAZIE AD UN PROCEDIMENTO SIMILE ALLA FOTOSINTESI
CLOROFFILIANA AIRCORAL[®] UCCIDE I BATTERI.

*AirCoral[®] transforms
the air's harmful substances
into harmless ones.*

*THANKS TO A PROCESS WHICH IS VERY SIMILAR TO CHLOROPHYLL
PHOTOSYNTHESIS AIRCORAL[®] KILLS BACTERIA.*

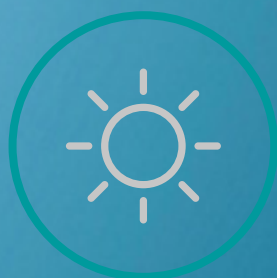

FOTOCATALITICO

capacità di
degrado degli elementi dannosi
testata con metodo UNI 11259.

PHOTOCATALITIC

*degradation ability harmful agents
tested with method UNI 11259.*



ANTIBATTERICO

capacità di
eliminazione totale dei batteri
dalle superfici
testata con metodo UNI 27447.

ANTIBACTERIAL

*ability to
complete elimination of bacteria
from surface
tested with method UNI 27447.*



MENO INQUINAMENTO

riduzione di 17 ppm
di gas hexano nell'aria.

LESS POLLUTION

*Less 17 ppm x n
hexano in the air.*

WATER LIGHT



WHAT ABOUT

Il materiale impermeabile ad acqua e umidità.

The material resistant to water and humidity.

PROOF

MORE THAN CORAL®

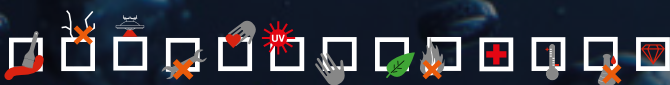

REPELENTE AI LIQUIDI
non necessita di trattamenti superficiali

WATERPROOF
no superficial treatments necessary

Materials

DC DURCORAL®

MORE THAN CORAL®



ANTIVANDALICO

elevata resistenza agli atti vandalici

VANDAL RESISTANT

high resistance to acts of vandalism



RESISTENZA MECCANICA ALLA FLESSIONE

resistenza alla flessione ≥ 55 N/mm²
resistenza alla compressione ≥ 140 N/mm²

MECHANICAL RESISTANCE TO BENDING

bending strength ≥ 55 N/mm²
compressive strength ≥ 140 N/mm²



ANTIGRAFFIO

elevata resistenza all'incisione anche con metalli

SCRATCH RESISTANT

high resistance to scratching even to metal implements



RESISTENZA ALL'ABRASIONE

spolverabilità ≤ 7 g/m²

ABRASION RESISTANCE

sprinkling ability ≤ 7 g/m²



INERTE ALLA SALINITÀ

possibilità di installazione in ambienti con elevata salinità

RESISTANT TO SALT ENVIRONMENTS

safe to install in high salt content environments



INERTE AL CLORO

possibilità di installazione in ambienti ad alta saturazione di cloro

RESISTANT TO CHLORINE ENVIRONMENTS

safe to install in high chlorine content environments



RESISTENZA AL GELO

insensibile all'esfoliazione per gelo e disgelo

FROST RESISTANCE

insensitive to exfoliation due to freezing and thawing



RESISTENZA AGLI AGENTI ATMOSFERICI

porosità all'acqua $\leq 2\%$

WEATHER RESISTANCE

porosity to water $\leq 2\%$



SUPERFICIE EXTRA FINE HI-TECH

elevata resistenza meccanica

EXTRA THIN HI-TECH SURFACE

high mechanical strength



DECORABILE CON PITTURA

customizzazione

PAINTABLE

customization

WHAT ABOUT

Il materiale per l'illuminazione più resistente del cemento.

The lighting material more resistant than cement.

THERE IS A CRACK IN
EVERYTHING.
THAT'S HOW
THE LIGHT GETS IN.

LEONARD COHEN



MATTER SHEDS LIGHT



RECESSED

The technical lighting with the plus of body invisibility



GENIUS



1000 lm IN SOLI 20 mm DI DIAMETRO.
FACILE MANUTENZIONE.

Un prodotto "geniale" a partire dalla forma, discreta ed elegante, in grado di integrarsi perfettamente con le superfici raggiungendo straordinari effetti di scomparsa totale. Genius garantisce una luminosità perfetta in ogni ambiente in cui viene installato: apparecchio da interni a scomparsa totale in AirCoral® per installazione a soffitto di cartongesso o laterizio, è in grado di generare un'intensità luminosa incredibile per un foro di emissione di soli 20 mm, così minimale da scomparire quando il prodotto è spento.

La parte elettrica è estraibile direttamente dal foro luce con un semplice gesto della mano, grazie alla meccanica push-pull, che facilita l'eventuale estrazione e la sostituzione della sorgente LED in caso di manutenzione.



1000 lm IN A DIAMETER OF ONLY 20 mm,
EASY MAINTENANCE.

A bright product starting from its shape, discreet and elegant, able to perfectly integrate itself inside architectures achieving extraordinary complete disappearance effects. Genius guarantees a perfect lighting in every environment it may be installed in: totally disappearing recessed luminaire for indoor spaces, made of AirCoral® and installable on plasterboard or brick ceilings, is able to emit an incredible light intensity for just a 20 mm emission hole, so tiny that it disappears when the product is turned off.

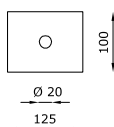
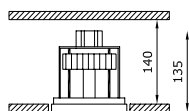
With a simple hand gesture, the electric part can be extracted directly from the hole which allows the light to pour out. This is possible thanks to the push-pull mechanism, which makes the eventual extraction and replacement of the LED source easier in case of maintenance.



TECHNICAL FEATURES

Code	1851.AC	1855.AC
Type	Downlight 90° 	Downlight 90° 
Material	AC: AirCoral®	AC: AirCoral®
Absorption capacity*	1.39 m ²	1.39 m ²
Weight	0.8 Kg	0.8 Kg
Mounting	Ceiling recessed	Ceiling recessed
IP rating	IP20	IP20
Insulation class	III	III
Control gear	Remote constant current electronic driver (not included)	Remote constant current electronic driver and inverter
Cut out for plasterboard	135 x 110 mm	135 x 110 mm
Lamp type	LED 700 mA Vf: 11.5 VDC	LED 700 mA Vf
Lamp wattage	1 x 8.5W	1 x 8.5W
Luminous efficacy	1000 lm - 3000K	1000 lm - 3000K
Light distribution	Wide beam 40°	Wide beam 40°
Fitting	-	-
Light colour	White 3000K White 2700K 4000K (on request)	White 3000K White 2700K 4000K (on request)
Light hole	Ø 20 mm	Ø 20 mm
Voltage connection	By driver (optional)	220-240V · 50/60Hz
CRI	>90	>90
Emergency	-	1 hour
Energy efficiency class	A++	A++
Note	On request available dimmable PUSH or DALI, remote installation. This product could be ordered with IP65 protection grade (see OUTDOOR section - code 1951.CW).	On request available dimmable PUSH or DALI, remote installation. This product could be ordered with IP65 protection grade (see OUTDOOR section - code 1952.CW).

OPTIONAL ACCESSORIES

product code	optional code	description	info
1851.AC	H8700.E	Constant current electronic driver. Remote installation	Suitable for n°1 or n°3 code 1851.AC - 700 mA
	BR1851LT	Brick box	Dimensions L: 195 mm; W: 140 mm; D: 160 mm (instructions on page 502)
1855.AC	BR1855LT	Brick box	Dimensions L: 195 mm; W: 140 mm; D: 160 mm (instructions on page 502)

* The absorption capacity per m² calculated by the American organization TCNA (Tile Council of North America) is measured for an average room of 2.7 m in height and therefore expressed in m²



SUPERFUTUREDESIGN™

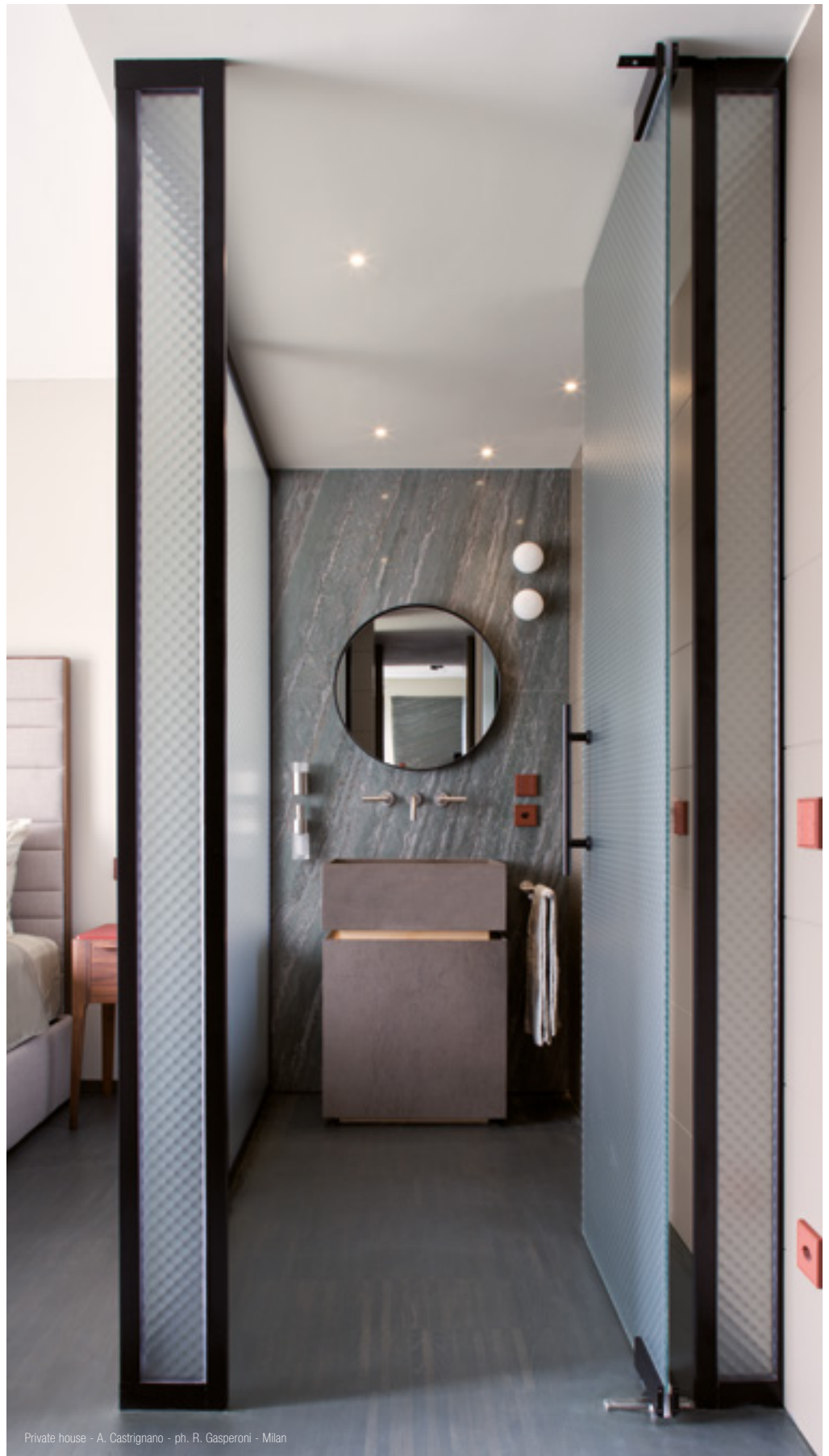

Private house - A. Castrignano - ph. R. Gasperoni - Milan



Private villa - Arch. E.Corti - Cap Ferrat Côte d'Azur





TWIN GENIUS



DOPPIA EFFICIENZA LUMINOSA E FACILE
MANUTENZIONE. MECCANISMO PUSH-PULL.

Il design di Genius si raddoppia: Twin Genius, apparecchio da interni a scomparsa totale in AirCoral® per installazione a soffitto di cartongesso o laterizio. I due fori di emissione di soli 20 mm scompaiono completamente quando il prodotto è spento; ritagliati all'interno del controsoffitto, in piena continuità con la superficie generano coni luminosi dal volume netto che rompono l'oscurità.

La parte elettrica è estraibile direttamente dal foro luce con un semplice gesto della mano, grazie alla meccanica push-pull, che facilita l'eventuale estrazione e la sostituzione della sorgente LED in caso di manutenzione.

*DOUBLE LIGHT EFFICIENCY AND EASY
MAINTENANCE, PUSH-PULL MECHANISM.*

The design of Genius doubles: Twin Genius, a totally disappearing recessed luminaire in AirCoral®, installable on plasterboard or brick ceilings. The two emission holes of just 20 mm almost disappear when the product is turned off: cut out inside the ceilings, in perfect continuity with the surfaces, these products are able to generate bright cones of light with clean volumes, breaking the darkness.

With a simple hand gesture, the electric part can be extracted directly from the hole which allows the light to pour out. This is possible thanks to the push-pull mechanism, which makes the eventual extraction and replacement of the LED source easier in case of maintenance.

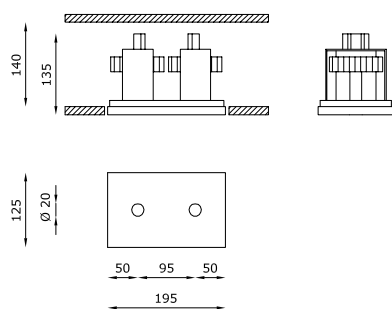

TECHNICAL FEATURES

Code	1852.AC	1857.AC
Type	Downlight 90° 	Downlight 90° 
Material	AC: AirCoral®	AC: AirCoral®
Absorption capacity*	2.78 m ²	2.78 m ²
Weight	2 Kg	2 Kg
Mounting	Ceiling recessed	Ceiling recessed
IP rating	IP20	IP20
Insulation class	III	III
Control gear	Remote constant current electronic driver (not included)	Remote constant current electronic driver and inverter
Cut out for plasterboard	205 x 135 mm	205 x 135 mm
Lamp type	LED 700 mA  Vf: 2 x 1.5 VDC	LED 700 mA 
Lamp wattage	2 x 8.5W	2 x 8.5W
Luminous efficacy	2 x 1000 lm - 3000K	2 x 1000 lm - 3000K
Light distribution	Wide beam 40°	Wide beam 40°
Fitting	-	-
Light colour	White 3000K White 2700K 4000K (on request)	White 3000K White 2700K 4000K (on request)
Light hole	Ø 20 mm	Ø 20 mm
Voltage connection	By driver (optional)	220-240V · 50/60Hz
CRI	>90	>90
Emergency	-	1 hour
Energy efficiency class	A++	A++
Note	On request available dimmable PUSH or DALI, remote installation.	On request available dimmable PUSH or DALI, remote installation.

OPTIONAL ACCESSORIES

product code	optional code	description	info
1852.AC	H8700.E	Constant current electronic driver. Remote installation	Suitable for n°1 code 1852.AC - 700 mA
	BR1852LT	Brick box	Dimensions L: 290 mm; W: 140 mm; D: 160 mm <i>(instructions on page 502)</i>
1857.AC	BR1857LT	Brick box	Dimensions L: 290 mm; W: 140 mm; D: 160 mm <i>(instructions on page 502)</i>

* The absorption capacity per m² calculated by the American organization TCNA (Tile Council of North America) is measured for an average room of 2.7 m in height and therefore expressed in m²



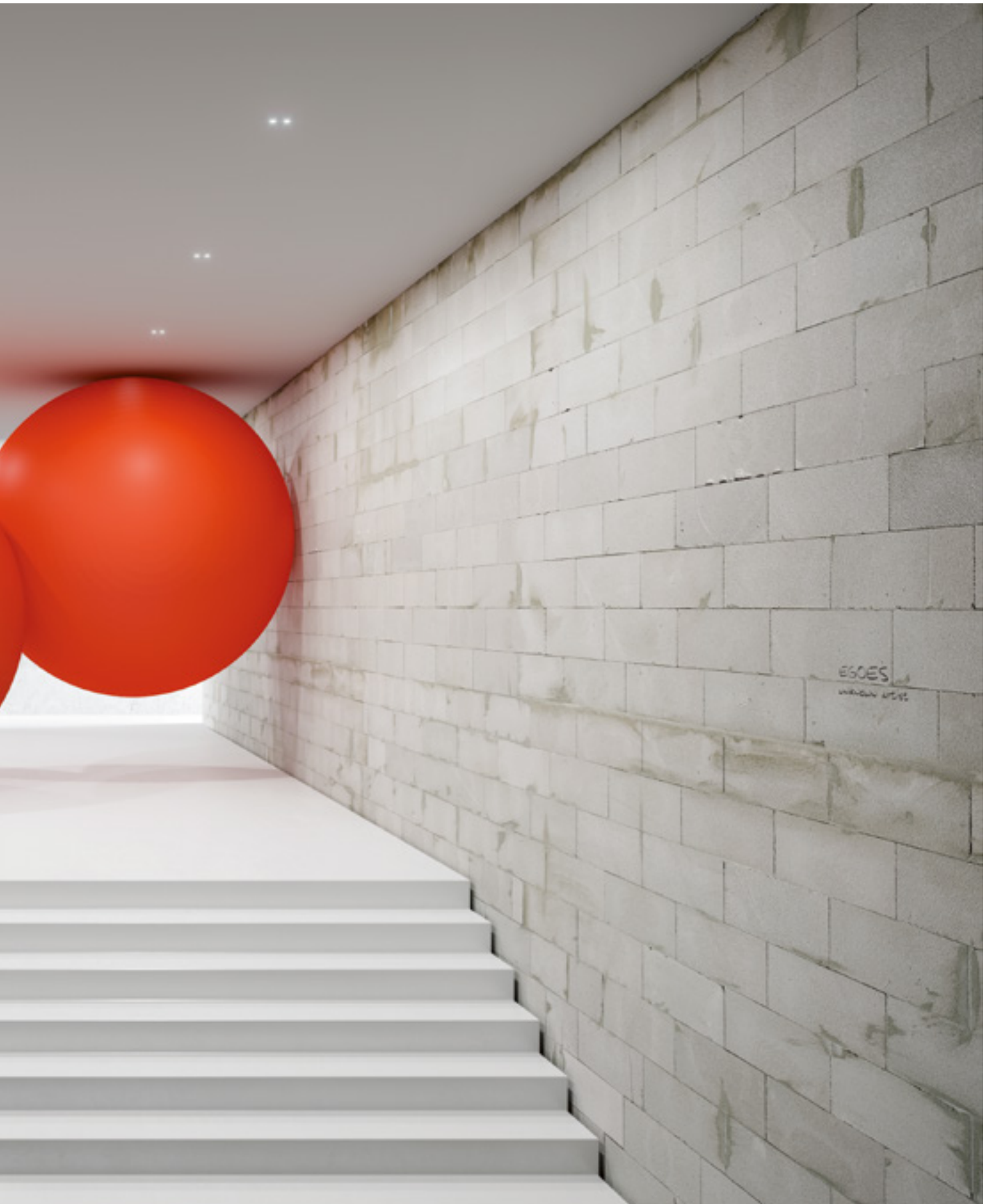



Private villa - Arch. E.Corti - Cap Ferrat Côte d'Azur



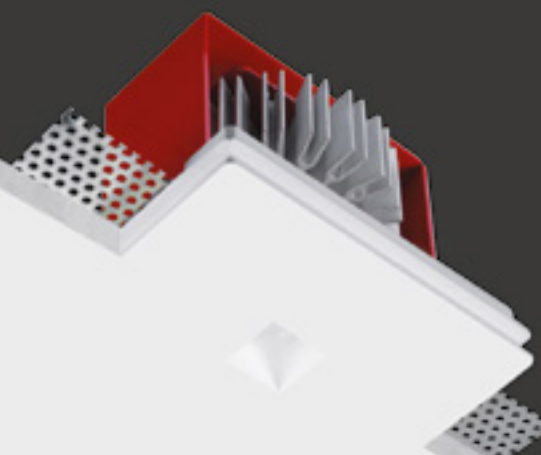

GENIUSQUARE



1000 lm DA UN FORO QUADRATO DI SOLI 20 x 20 mm.

La forma classica del foro di emissione del Genius muta, trasformandosi in quadrata. Sempre discreto ed elegante, si integra perfettamente con le superfici raggiungendo straordinari effetti di scomparsa totale: Geniusquare, apparecchio da interni a scomparsa totale in AirCoral® per installazione a soffitto di cartongesso o laterizio, abbraccia gli oggetti minimizzando il punto luce fino al suo ideale annientamento, in una perfetta sintesi di estetica e tecnologia avanzata.

La parte elettrica è estraibile direttamente dal foro luce con un semplice gesto della mano, grazie alla meccanica push-pull, che facilita l'eventuale estrazione e la sostituzione della sorgente LED in caso di manutenzione.



1000 lm FROM A SQUARE HOLE OF ONLY 20 x 20 mm.

The classic shape of Genius' light emission hole changes, and becomes squared. As always discreet and elegant, it perfectly integrates itself with surfaces achieving extraordinary complete disappearance effects: Geniusquare, a totally disappearing recessed luminaire in AirCoral®, installable on plasterboard or brick ceilings, surrounds objects minimizing the light source up to its ideal disappearance, in a perfect synthesis of aesthetics and advanced technology.

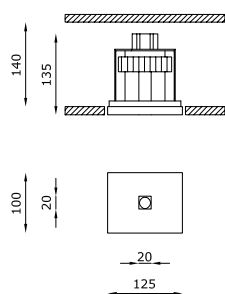
With a simple hand gesture, the electric part can be extracted directly from the hole which allows the light to pour out. This is possible thanks to the push-pull mechanism, which makes the eventual extraction and replacement of the LED source easier in case of maintenance.



TECHNICAL FEATURES

Code	1853.AC	1856.AC
Type	Downlight 90° 	Downlight 90° 
Material	AC: AirCoral®	AC: AirCoral®
Absorption capacity*	1.39 m ²	1.39 m ²
Weight	0.8 Kg	0.8 Kg
Mounting	Ceiling recessed	Ceiling recessed
IP rating	IP20	IP20
Insulation class	III	III
Control gear	Remote constant current electronic driver (not included)	Remote constant current electronic driver and inverter
Cut out for plasterboard	135 x 110 mm	135 x 110 mm
Lamp type	LED 700 mA ⚡ V _f : 11.5 VDC	LED 700 mA ⚡
Lamp wattage	1 x 8.5W	1 x 8.5W
Luminous efficacy	1000 lm - 3000K	1000 lm - 3000K
Light distribution	Wide beam 40°	Wide beam 40°
Fitting	-	-
Light colour	White 3000K White 2700K 4000K (on request)	White 3000K White 2700K 4000K (on request)
Light hole	20 X 20 mm	20 X 20 mm
Voltage connection	By driver (optional)	220-240V - 50/60Hz
CRI	>90	>90
Emergency	-	1 hour
Energy efficiency class	A++	A++
Note	On request available dimmable PUSH or DALI, remote installation.	On request available dimmable PUSH or DALI, remote installation.

OPTIONAL ACCESSORIES

product code	optional code	description	info
1853.AC	H8700.E	Constant current electronic driver. Remote installation	Suitable for n°1 or n°3 code 1853.AC - 700 mA
	BR1853LT	Brick box	Dimensions L: 195 mm; W: 140 mm; D: 160 mm <i>(instructions on page 502)</i>
1856.AC	BR1856LT	Brick box	Dimensions L: 195 mm; W: 140 mm; D: 160 mm <i>(instructions on page 502)</i>

* The absorption capacity per m² calculated by the American organization TCNA (Tile Council of North America) is measured for an average room of 2.7 m in height and therefore expressed in m²





HOW JONAH LEFT THE WHALE



TWIN GENIUSQUARE



DOPPIA EFFICIENZA LUMINOSA DA 2 FORI
DI SOLI 20 x 20 mm.

Geniusquare si duplica e diventa Twin Geniusquare, apparecchio da interni a scomparsa totale in AirCoral® per installazione a soffitto di cartongesso o laterizio, garantendo un'intensità luminosa incredibile. Il doppio foro di emissione della luce di soli 20 mm permette al prodotto di integrarsi perfettamente con le superfici, raggiungendo straordinari effetti di scomparsa totale e garantendo una luminosità perfetta in ogni ambiente in cui viene installato.

La parte elettrica è estraibile direttamente dal foro luce con un semplice gesto della mano, grazie alla meccanica push-pull, che facilita l'eventuale estrazione e la sostituzione della sorgente LED in caso di manutenzione.

*DOUBLE LIGHT EFFICIENCY FROM 2 HOLES
OF ONLY 20 x 20 mm.*



Geniusquare duplicates itself becoming Twin Geniusquare, a totally disappearing recessed luminaire in AirCoral® installable on plasterboard or brick ceilings and guaranteeing an incredible light intensity.

The double light-emission hole, which is only 20mm wide, allows the product to perfectly integrate itself with the surfaces it is installed on, adding extraordinary effects of total disappearance and offering a flawless light suitable for any environments.

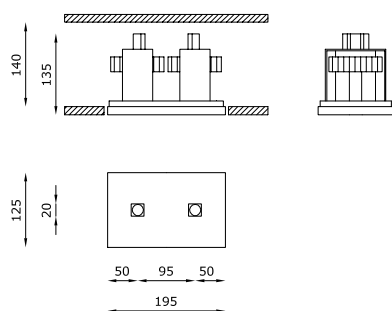
With a simple hand gesture, the electric part can be extracted directly from the hole which allows the light to pour out. This is possible thanks to the push-pull mechanism, which makes the eventual extraction and replacement of the LED source easier in case of maintenance.



TECHNICAL FEATURES

Code	1854.AC	1858.AC
Type	Downlight 90° 	Downlight 90° 
Material	AC: AirCoral®	AC: AirCoral®
Absorption capacity*	2.78 m ²	2.78 m ²
Weight	2 Kg	2 Kg
Mounting	Ceiling recessed	Ceiling recessed
IP rating	IP20	IP20
Insulation class	III	III
Control gear	Remote constant current electronic driver (not included)	Remote constant current electronic driver and inverter
Cut out for plasterboard	205 x 135 mm	205 x 135 mm
Lamp type	LED 700 mA  Vf: 2 x 11.5 VDC	LED 700 mA 
Lamp wattage	2 x 8.5W	2 x 8.5W
Luminous efficacy	2 x 1000 lm - 3000K	2 x 1000 lm - 3000K
Light distribution	Wide beam 40°	Wide beam 40°
Fitting	-	-
Light colour	White 3000K White 2700K 4000K (on request)	White 3000K White 2700K 4000K (on request)
Light hole	20 x 20 mm	20 x 20 mm
Voltage connection	By driver (optional)	220-240V · 50/60Hz
CRI	>90	>90
Emergency	-	1 hour
Energy efficiency class	A++	A++
Note	On request available dimmable PUSH or DALI, remote installation.	On request available dimmable PUSH or DALI, remote installation.

OPTIONAL ACCESSORIES

product code	optional code	description	info
1854.AC	H8700.E	Constant current electronic driver. Remote installation	Suitable for n°1 code 1854.AC - 700 mA
	BR1854LT	Brick box	Dimensions L: 290 mm; W: 140 mm; D: 160 mm <i>(instructions on page 502)</i>
1858.AC	BR1858LT	Brick box	Dimensions L: 290 mm; W: 140 mm; D: 160 mm <i>(instructions on page 502)</i>

* The absorption capacity per m² calculated by the American organization TCNA (Tile Council of North America) is measured for an average room of 2.7 m in height and therefore expressed in m²







GENIUS DYNAMIC WHITE



DIMMERAZIONE DEL BIANCO IN SOLI 20 mm
DI DIAMETRO.

Genius Dynamic White è un incasso a scomparsa totale da interni in AirCoral® per installazione in soffitto di cartongesso o laterizio con un foro luce di soli 20mm, così minimale da scomparire quando il prodotto è spento, e dotato di un chip su cui sono installati 4 LED che permettono di cambiare la temperatura colore.

In grado di percorrere un range da 2700K a 5000K che valorizza e riproduce il completo ciclo circadiano, orologio biologico del corpo. Questa particolarità incrementa il livello di capacità cognitiva dell'organismo e aumenta il metabolismo del corpo, migliorando in modo tangibile il tempo di reazione agli stimoli visivi.

Il design minimalista del Genius si unisce al potenziale benefico della luce: per questo Genius Dynamic White è particolarmente adatto per essere installato in ambienti di lavoro e di studio, oltre che per tutti gli spazi di vita. La parte elettrica è estraibile direttamente dal foro luce con un semplice gesto della mano, grazie alla meccanica push-pull, che facilita l'eventuale estrazione e la sostituzione della sorgente LED in caso di manutenzione.

*DIMMERING OF WHITE IN A DIAMETER OF
ONLY 20 mm.*

Genius Dynamic White is a total recessed indoor luminaire made of AirCoral® and installable on plasterboard or brick ceilings. The light emission hole of minimal design, only 20mm wide, disappears when the luminaire is off and is provided with a chip with 4 LED lights which allows to regulate colour temperature.



The light emanated by this product can vary from 2700K to 5000K, reproducing and valorizing the entire circadian cycle, the biological clock of our body. This particular characteristic enhances the cognitive level of our organism together with the metabolic activity of our body, concretely improving our capacity to react to visual impulses.

Genius' minimal design mingles with the healthy properties of light: that is why Genius Dynamic White is particularly suitable for study or work environments as well as for any kinds of living spaces.

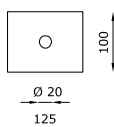
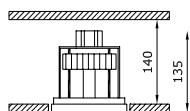
The electrical part can be extracted directly from the emission hole with a simple hand gesture. This is possible thanks to the push-pull mechanism, which facilitates the eventual extraction and replacing of the LED source in case of maintaining.



TECHNICAL FEATURES

Code	1881.AC
Type	Downlight 90° 
Material	AC: AirCoral®
Absorption capacity*	1.39 m ²
Weight	0.8 Kg
Mounting	Ceiling recessed
IP rating	IP20
Insulation class	III
Control gear	Remote constant current electronic driver (not included)**
Cut out for plasterboard	135 x 110 mm
Lamp type	LED  1 x 700mA · Vf: 6 VDC 5000K  1 x 700mA · Vf: 6 VDC 2700K
Lamp wattage	1 x 8.5W
Luminous efficacy	from 364 lm up to 446 lm (from 2700K up to 5000K)
Light distribution	Wide beam 40°
Fitting	-
Light colour	White 2700/5000K
Light hole	Ø 20 mm
Voltage connection	By driver (optional)
CRI	90
Emergency	-
Energy efficiency class	A++
Note	On request available dimmable PUSH or DALI, remote installation. **Genius Dynamic White requires separate power for the 2700K and 5000K. It's possible to use one driver dual channel or two drivers single channel for each. This product could be ordered with IP65 protection grade.

OPTIONAL ACCESSORIES

<i>product code</i>	<i>optional code</i>	<i>description</i>	<i>info</i>
1881.AC	BR1881LT	Brick box	Dimensions L: 195 mm; W: 140 mm; D: 160 mm (<i>instructions on page 502</i>)
	H8700DA	Dimmable constant current electronic driver. Remote installation	You need 2 drivers code H8700DA for one code 1881.AC if installed alone. Attention: with 2 codes H8700DA you are also able to power maximum 2 Genius Dynamic White 1881.AC

* The absorption capacity per m² calculated by the American organization TCNA (Tile Council of North America) is measured for an average room of 2.7 m in height and therefore expressed in m²

Genius Dynamic White







GENIUS DIM TO WARM



DIMMERAZIONE DEL COLORE BIANCO E DELLA POTENZA CON UN SOLO DRIVER.

Genius Dim to Warm è un apparecchio a scomparsa totale, con scocca realizzata in AirCoral®, ideale per installazioni a soffitto in interni, sia su cartongesso che laterizio.

Mantenendo invariate tutte le caratteristiche del Genius originale, la tecnologia LED qui impiegata permette sia il controllo dell'intensità della luce che della temperatura colore, dimmerabile da 1800K a 3000K. Un prodotto con CRI 95, che garantisce tutta l'innovazione tecnologica digitale, ripercorrendo allo stesso tempo le emozioni dell'alogeno.

La parte elettrica è estraibile direttamente dal foro luce, grazie alla meccanica push-pull, che facilita l'estrazione e la sostituzione della sorgente LED. L'unica apertura visibile è il foro da 23 mm, senza la necessità di alcuna botola di ispezione e tantomeno di interventi invasivi in caso di manutenzione.

DIMMERING OF WHITE COLOUR AND POWER WITH ONE SINGLE DRIVER.

Genius Dim to Warm is a totally recessed luminaire, with body made in AirCoral®, ideal for indoor ceiling-mounted installations, both on drywall and bricks.

Without changing any of the features of the original Genius, the LED technology used here allows both light intensity and colour temperature control, dimmable from 1800K to 3000K, to be controlled. A product with CRI 95, which guarantees all digital technology has to offer, while continuing to give the emotions of halogen.

The electrical part can be removed through the light hole, thanks to a push-pull mechanism making it easy to pull the LED light source out and replace it. The only visible aperture is the 23 mm (0.9") outlet, with no need for any inspection hatch, nor for invasive maintenance operations.

DIMMERABILE DIM TO WARM DA 1800K A 3000K

DIMMABLE DIM TO WARM
FROM 1800K TO 3000K



massimo controllo di intensità
luminosa e temperatura colore
gestibili contemporaneamente
con un unico driver

*maximum control of light
intensity and colour temperature
manageable at the same time
with a single driver*

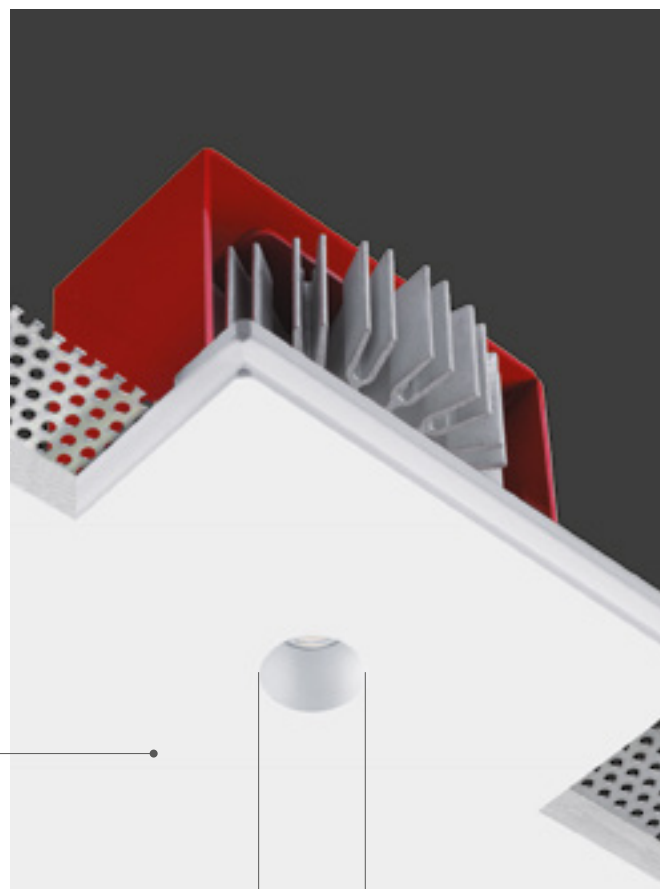

23 mm

l'unica parte visibile è il foro di soli 23 mm

*the only visible part is the emission hole
of 23 mm (0.9")*

PUSH & PULL TECHNOLOGY

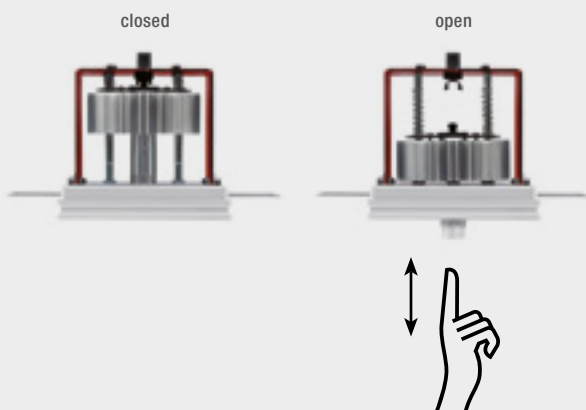

Non necessita di alcuna botola di ispezione. La parte elettrica è estraibile direttamente dal foro luce con un semplice gesto della mano, grazie alla meccanica push-pull, che facilita l'eventuale estrazione e la sostituzione della sorgente LED in caso di manutenzione.

No need for an inspection hatch. The electrical part can be extracted straight from the light hole just with a simple manual gesture, thanks to the push-pull mechanism which makes it easy to extract and replace the LED source for maintenance purposes.

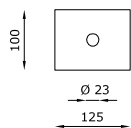
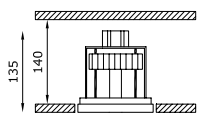

Genius Dim To Warm



CODE COMPOSITION

1875.AC 7 R 40 E 98 WD

TECHNICAL FEATURES

Code	1875.AC XX
Type	Downlight 90° 
Material	AC: AirCoral®
Absorption capacity*	1.39 m ²
Weight	0.8 Kg
Mounting	Ceiling recessed
IP rating	IP20
Insulation class	III
Control gear	Remote constant current electronic driver** (not included)
Cut out for plasterboard	135 x 110 mm
Lamp type	LED 350 mA  Vf: 17 VDC
Lamp wattage	1 x 6W
Luminous efficacy	600 lm (from 1800K up to 3000K)
Light distribution	Wide beam 40°
Fitting	-
Light colour	Dimming range 1800/3000K
Light hole	Ø 23 mm
Voltage connection	By driver (optional)
CRI	95
Emergency	-
Energy efficiency class	A++
Note	On request available dimmable PUSH or DALI, remote installation.

**Genius Dim To Warm requires dimming: amplitude (AM) IEEE1789-2015 dim to warm wide range input voltage.

OPTIONAL ACCESSORIES

<i>product code</i>	<i>optional code</i>	<i>description</i>	<i>info</i>
1875.AC XX	H8350DA.AM	Dimming: amplitude (AM) DALI	Suitable for n°2 code 1875.AC XX
	H8350PH.AM	Dimming: amplitude (AM) PUSH	Suitable for n°2 code 1875.AC XX
	BR1875LT	Brick box	Dimensions L: 195 mm; W: 140 mm; D: 160 mm <i>(instructions on page 502)</i>



3000K

2500K

1800K



GENIUS BRASS



RIFLESSI DORATI SENZA ALTERARE IL COLORE DELLA LUCE.

Genius Brass in AirCoral® è un incasso a scomparsa totale da interni per installazione in soffitto di cartongesso o laterizio. Il foro di emissione luce, di soli 20 mm e dotato di un cilindro in ottone, dona un tocco prezioso ad un prodotto già estremamente raffinato. Genius Brass è un prodotto che con le sue caratteristiche contribuisce ad aumentare il comfort visivo e generare una tonalità di luce più calda, rendendo gli ambienti più accoglienti.

La parte elettrica è estraibile direttamente dal foro luce con un semplice gesto della mano, grazie alla meccanica push-pull, che facilita l'eventuale estrazione e la sostituzione della sorgente LED in caso di manutenzione.

GOLDEN REFLEXES WITHOUT CHANGING THE COLOUR OF THE LIGHT.

Genius Brass is a total recessed indoor luminaire made of AirCoral® and installable on plasterboards or brick ceilings. The light emission hole, only 20 mm wide, is provided with a brass cylinder which gives a precious touch to a product already extremely elegant. Genius Brass' characteristics enhance visual comfort and generates a warm light which makes the environments more welcoming.

The electrical part can be extracted directly from the emission hole with a simple hand gesture. This is possible thanks to the push-pull mechanism, which facilitates the eventual extraction and replacing of the LED source in case of maintaining.

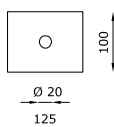
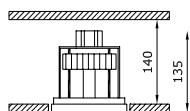

TECHNICAL FEATURES

Code	1861.AC	1862.AC
Type	Downlight 90° 	Downlight 90° 
Material	AC: AirCoral®	AC: AirCoral®
Absorption capacity*	1.39 m²	1.39 m²
Weight	0.8 Kg	0.8 Kg
Mounting	Ceiling recessed	Ceiling recessed
IP rating	IP20	IP20
Insulation class	III	III
Control gear	Remote constant current electronic driver (not included)	Remote constant current electronic driver and inverter
Cut out for plasterboard	135 x 110 mm	135 x 110 mm
Lamp type	LED 700 mA  Vf: 11.5 VDC	LED 700 mA 
Lamp wattage	1 x 8.5W	1 x 8.5W
Luminous efficacy	1000 lm - 3000K	1000 lm - 3000K
Light distribution	Wide beam 40°	Wide beam 40°
Fitting	-	-
Light colour	White 3000K White 2700K 4000K (on request)	White 3000K White 2700K 4000K (on request)
Light hole	Ø 20 mm	Ø 20 mm
Voltage connection	By driver (optional)	220-240V · 50/60Hz
CRI	>90	>90
Emergency	-	1 hour
Energy efficiency class	A++	A++
Note	On request available dimmable PUSH or DALI, remote installation.	On request available dimmable PUSH or DALI, remote installation.

OPTIONAL ACCESSORIES

product code	optional code	description	info
1861.AC	H8700.E	Constant current electronic driver. Remote installation	Suitable for n°1 or n°3 code 1861.AC - 700 mA
	BR1861LT	Brick box	Dimensions L: 195 mm; W: 140 mm; D: 160 mm <i>(instructions on page 502)</i>
1862.AC	BR1862LT	Brick box	Dimensions L: 195 mm; W: 140 mm; D: 160 mm <i>(instructions on page 502)</i>

* The absorption capacity per m³ calculated by the American organization TCNA (Tile Council of North America) is measured for an average room of 2.7 m in height and therefore expressed in m²





Il foyer, Piazza Teatro alla Scala – Michael Vincent Uy MVUY – Milan



GENIUSQUARE BRASS



RIFLESSI DORATI SENZA ALTERARE IL COLORE DELLA LUCE.

Geniusquare Brass è un apparecchio a scomparsa totale, con scocca realizzata in AirCoral®, ideale per installazioni a soffitto in interni, sia su cartongesso che laterizio. In questa variante, che conserva tutte le caratteristiche della linea Genius, l'arretramento del punto luce è corredato da un inserto in ottone che partecipa alla diffusione luminosa, generando una tonalità di luce più calda e sfumature variegata adatte a situazioni di "relaxed ambience".

La parte elettrica è estraibile direttamente dal foro luce, grazie alla meccanica push-pull, che facilita l'estrazione e la sostituzione della sorgente LED. L'unica apertura visibile è il foro da 20 x 20 mm, senza la necessità di alcuna botola di ispezione e tantomeno di interventi invasivi in caso di manutenzione.

GOLDEN REFLEXES WITHOUT CHANGING THE COLOUR OF THE LIGHT.

Geniusquare Brass is a totally recessed luminaire, with body made in AirCoral®, ideal for indoor ceiling-mounted installations, both on drywall and bricks.

In this version, which retains all the features of the Genius line, the backing on the light emission hole is fitted with a brass insert which helps to spread light, generating a warmer tone and variegated shades suitable for relaxed ambience situations.

The electrical part can be removed through the light hole, thanks to a push-pull mechanism making it easy to pull the LED light source out and replace it.

The only visible aperture is the 20 x 20 mm (0.79" x 0.79") outlet, with no need for any inspection hatch, nor for invasive maintenance operations.

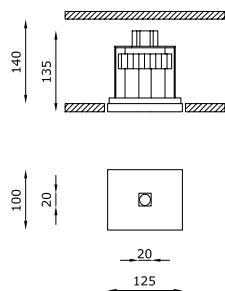

CODE COMPOSITION

1895.AC 4 R 40 E _ WD

light colour

27	2700K
30	3000K
40	4000K





1896.AC 4 R 40 E _ ND

light colour

27	2700K
30	3000K
40	4000K

example of code composition 1895.AC 4 R 40 E 30 WD

TECHNICAL FEATURES

Code	1895.AC XX	1896.AC XX
Type	Downlight 90° 	Downlight 90° 
Material	AC: AirCoral®	AC: AirCoral®
Absorption capacity*	1.39 m ²	1.39 m ²
Weight	0.8 Kg	0.8 Kg
Mounting	Ceiling recessed	Ceiling recessed
IP rating	IP20	IP20
Insulation class	III	III
Control gear	Remote constant current electronic driver (not included)	Remote constant current electronic driver and inverter (included)
Cut out for plasterboard	135 x 110 mm	135 x 110 mm
Lamp type	LED 700 mA  Vf: 11.5 VDC	LED 700 mA 
Lamp wattage	1 x 8.5W	1 x 8.5W
Luminous efficacy	1000 lm - 3000K	1000 lm - 3000K
Light distribution	Wide beam 40°	Wide beam 40°
Fitting	-	-
Light colour	White 3000K White 2700K 4000K (on request)	White 3000K White 2700K 4000K (on request)
Light hole	20 x 20 mm	20 x 20 mm
Voltage connection	By driver (optional)	220-240V · 50/60Hz
CRI	>90	>90
Emergency	-	1 hour
Energy efficiency class	A++	A++
Note	On request available dimmable PUSH or DALI, remote installation.	On request available dimmable PUSH or DALI, remote installation.

OPTIONAL ACCESSORIES

product code	optional code	description	info
1895.AC XX	H8700.E	Constant current electronic driver. Remote installation	Suitable for n°1 or n°3 code 1895.AC XX - 700 mA
	BR1895LT	Brick box	Dimensions L: 195 mm; W: 140 mm; D: 160 mm
1896.AC XX	BR1896LT	Brick box	Dimensions L: 195 mm; W: 140 mm; D: 160 mm

* The absorption capacity per m² calculated by the American organization TCNA (Tile Council of North America) is measured for an average room of 2.7 m in height and therefore expressed in m²



GENIUS BLACK



GENIUS A ZERO ABBAGLIAMENTO.



Genius Black è un incasso a scomparsa totale da interni in AirCoral® per installazione in soffitto di cartongesso o laterizio. Il foro di emissione luce, di soli 20 mm di diametro, viene coestruso con un cilindro nero di alluminio anodizzato arricchendo di eleganza un prodotto puramente tecnico. L'effetto antiabbagliante del collare di colore nero rende il prodotto altamente raffinato: accentua infatti il valore estetico e rende Genius Black la soluzione ideale in tutti gli ambienti che ricercano eleganza. La parte elettrica è estraibile direttamente dal foro luce con un semplice gesto della mano, grazie alla meccanica push-pull, che facilita l'eventuale estrazione e la sostituzione della sorgente LED in caso di manutenzione.

GENIUS WITH ZERO DAZZLING.

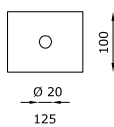
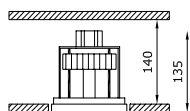
Genius Black is a total recessed indoor luminaire of AirCoral® installable on plasterboard or brick ceilings. The light emission hole, only 20 mm wide, is co-extruded with a black cylinder of anodized aluminium which elegantly embellishes a pure technical product. The anti-reflection effect of the black collar makes the luminaire an example of great, refined style: in fact, this characteristic enhances the aesthetics of the product, making Genius Black the ideal solution for environments that require elegance. The electrical part can be extracted directly from the emission hole with a simple hand gesture. This is possible thanks to the push-pull mechanism, which facilitates the eventual extraction and replacing of the LED source in case of maintaining.



TECHNICAL FEATURES

Code	1871.AC	1872.AC
Type	Downlight 90° 	Downlight 90° 
Material	AC: AirCoral®	AC: AirCoral®
Absorption capacity*	1.39 m ²	1.39 m ²
Weight	0.8 Kg	0.8 Kg
Mounting	Ceiling recessed	Ceiling recessed
IP rating	IP20	IP20
Insulation class	III	III
Control gear	Remote constant current electronic driver (not included)	Remote constant current electronic driver and inverter
Cut out for plasterboard	135 x 110 mm	135 x 110 mm
Lamp type	LED 700 mA Vf: 11.5 VDC	LED 700 mA Vf: 11.5 VDC
Lamp wattage	1 x 8.5W	1 x 8.5W
Luminous efficacy	1000 lm - 3000K	1000 lm - 3000K
Light distribution	Wide beam 40°	Wide beam 40°
Fitting	-	-
Light colour	White 3000K White 2700K 4000K (on request)	White 3000K White 2700K 4000K (on request)
Light hole	Ø 20 mm	Ø 20 mm
Voltage connection	By driver (optional)	220-240V · 50/60Hz
CRI	>90	>90
Emergency	-	1 hour
Energy efficiency class	A++	A++
Note	On request available dimmable PUSH or DALI, remote installation.	On request available dimmable PUSH or DALI, remote installation.

OPTIONAL ACCESSORIES

product code	optional code	description	info
1871.AC	H8700.E	Constant current electronic driver. Remote installation	Suitable for n°1 or n°3 code 1871.AC - 700 mA
	BR1871LT	Brick box	Dimensions L: 195 mm; W: 140 mm; D: 160 mm (instructions on page 502)
1872.AC	BR1872LT	Brick box	Dimensions L: 195 mm; W: 140 mm; D: 160 mm (instructions on page 502)

* The absorption capacity per m² calculated by the American organization TCNA (Tile Council of North America) is measured for an average room of 2.7 m in height and therefore expressed in m²



GENIUS CURVE



FORO STONDATO E FACILE MANUTENZIONE.
SISTEMA PUSH-PULL.



I volumi del Genius si ammorbidiscono e nasce Genius Curve: incasso a scomparsa totale da interni in AirCoral® per installazione in soffitto di cartongesso o laterizio, in cui la forma perfetta del cerchio acquista un nuovo potenziale livello decorativo. La luce si diffonde uniformemente nell'ambiente scivolando, elegante, sul foro di emissione stonato. Forma, luce e tecnica si incontrano per donare grande plasticità al soffitto e un'irripetibile esperienza visiva nell'ambiente. La parte elettrica è estraibile direttamente dal foro luce con un semplice gesto della mano, grazie alla meccanica push-pull, che facilita l'eventuale estrazione e la sostituzione della sorgente LED in caso di manutenzione.

*ROUNDED HOLE AND EASY MAINTENANCE.
PUSH-PULL SYSTEM.*

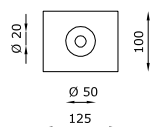
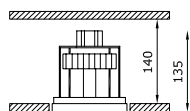
Genius' volumes become softer, giving birth to Genius Curve, a total recessed indoor luminaire made of AirCoral® and installable on plasterboard or brick ceilings. Its perfect circular form allows a higher level of decorative potential: light scatters uniformly in the environment, elegantly sliding on the round emission hole. Form, light and technique meet and combine, giving great plasticity to the ceiling and guaranteeing an unrepeatabe visual experience. The electrical part can be extracted directly from the emission hole with a simple hand gesture. This is possible thanks to the push-pull mechanism, which facilitates the eventual extraction and replacing of the LED source in case of maintaining.



TECHNICAL FEATURES

Code	1891.AC	1892.AC
Type	Downlight 90° 	Downlight 90° 
Material	AC: AirCoral®	AC: AirCoral®
Absorption capacity*	1.39 m ²	1.39 m ²
Weight	0.8 Kg	0.8 Kg
Mounting	Ceiling recessed	Ceiling recessed
IP rating	IP20	IP20
Insulation class	III	III
Control gear	Remote constant current electronic driver (not included)	Remote constant current electronic driver and inverter
Cut out for plasterboard	135 x 110 mm	135 x 110 mm
Lamp type	LED 700 mA Vf: 11.5 VDC	LED 700 mA Vf
Lamp wattage	1 x 8.5W	1 x 8.5W
Luminous efficacy	1000 lm - 3000K	1000 lm - 3000K
Light distribution	Wide beam 40°	Wide beam 40°
Fitting	-	-
Light colour	White 3000K White 2700K 4000K (on request)	White 3000K White 2700K 4000K (on request)
Light hole	Ø 20 mm	Ø 20 mm
Voltage connection	By driver (optional)	220-240V · 50/60Hz
CRI	>90	>90
Emergency	-	1 hour
Energy efficiency class	A++	A++
Note	On request available dimmable PUSH or DALI, remote installation.	On request available dimmable PUSH or DALI, remote installation.

OPTIONAL ACCESSORIES

product code	optional code	description	info
1891.AC	H8700.E	Constant current electronic driver. Remote installation	Suitable for n°1 or n°3 code 1891.AC - 700 mA
	BR1891LT	Brick box	Dimensions L: 195 mm; W: 140 mm; D: 160 mm (instructions on page 502)
1892.AC	BR1892LT	Brick box	Dimensions L: 195 mm; W: 140 mm; D: 160 mm (instructions on page 502)

* The absorption capacity per m² calculated by the American organization TCNA (Tile Council of North America) is measured for an average room of 2.7 m in height and therefore expressed in m²

Genius Curve



SUPERFUTUREDESIGN™





GENIUS BASIC



LUCE RETROCESSA, MINIMO INGOMBRO POSTERIORE.

La versione miniaturizzata di Genius vive ora con Genius Basic: variante dalle dimensioni più compatte, realizzata in Coral®. Apparecchio da incasso a scomparsa totale per interni, Genius Basic è in grado di soddisfare le esigenze del Contract Business, con la consueta affidabilità tecnica di Buzzi & Buzzi.

Un prodotto efficiente e dalle alte prestazioni, in grado di raggiungere 540 lm di emissione da un foro di luce da 20 mm, ma ancora più compatto e installabile in soli 80 mm di intercapedine. Come in tutta la gamma Genius, la variante Basic ha la parte elettrica direttamente estraibile dal foro luce, grazie a un nuovo sistema che facilita l'estrazione e la sostituzione della sorgente LED. L'unica apertura visibile è il foro luce da 20 mm, senza la necessità di alcuna botola di ispezione e tantomeno di interventi invasivi in caso di manutenzione.

REAR LIGHT, MINIMUM REAR DIMENSIONS.

The miniaturised version of Genius is now available with Genius Basic: a version with more compact dimensions, made in Coral®. A totally recessed luminaire for indoor use, Genius Basic satisfies Contract Business needs, with the usual technical reliability of Buzzi & Buzzi.

An efficient product with high performances, able to achieve 540 lm emission from the usual 20 mm (0.79") hole, but even more compact and installable in a cavity of only 80 mm (3.15").

As in the whole Genius range, the Basic version has an electrical part which can be removed through the light hole, thanks to a mechanism that makes it easy to pull the LED light source out and replace it. The only visible aperture is the light emission hole measuring 20 mm (0.79"), so there is no need for any inspection hatch, nor for invasive maintenance operations.

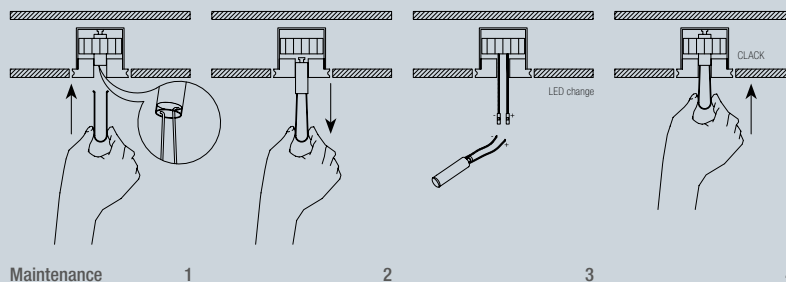
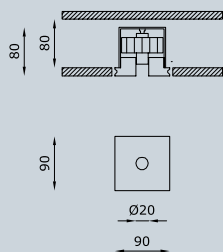

CODE COMPOSITION

1885.00 4 R 24 E _ WD

light colour

27	2700K
30	3000K
40	4000K

1886.00 4 R 24 E _ ND

light colour

27	2700K
30	3000K
40	4000K

example of code composition 1885.00 4 R 24 E **30** WD

TECHNICAL FEATURES

Code	1885.00 XX	1886.00 XX
Type	Downlight 90° 	Downlight 90°
Material	00: Coral®	00: Coral®
Weight	0.65 Kg	0.65 Kg
Mounting	Ceiling recessed	Ceiling recessed
IP rating	IP20	IP20
Insulation class	III	III
Control gear	Remote constant current electronic driver (not included)	Remote constant current electronic driver and inverter (included)
Cut out for plasterboard	100 x 100 mm	100 x 100 mm
Lamp type	LED 700 mA Vf: 6.5 VDC	LED 700 mA
Lamp wattage	1 x 4.5W	1 x 4.5W
Luminous efficacy	540 lm - 3000K	540 lm - 3000K
Light distribution	Wide beam 24°	Wide beam 24°
Fitting	-	-
Light colour	White 3000K White 2700K 4000K (on request)	White 3000K White 2700K 4000K (on request)
Light hole	Ø 20 mm	Ø 20 mm
Voltage connection	By driver (optional)	220-240V · 50/60Hz
CRI	>90	>90
Emergency	-	1 hour
Energy efficiency class	A++	A++
Note	On request available dimmable PUSH or DALI, remote installation. This product could be ordered with IP65 protection grade (code 1985.CW).	On request available dimmable PUSH or DALI, remote installation. This product could be ordered with IP65 protection grade (code 1986.CW).

OPTIONAL ACCESSORIES

product code	optional code	description	info
1885.00 XX	H8700.E	Constant current electronic driver. Remote installation	Suitable for n°3 code 1885.AC XX - 700 mA
	BR1885LT	Brick box	Dimensions L: 195 mm; W: 105 mm; D: 110 mm
1886.00 XX	BR1886LT	Brick box	Dimensions L: 195 mm; W: 105 mm; D: 110 mm







GENIUS BASIC FLAT



IL GENIUS IN SOLI 60 mm DI SPESSORE.

Apparecchio da incasso a scomparsa totale con scocca in Coral[®], ideale per applicazioni a soffitto in ambienti interni.

Genius Basic Flat è il più compatto della famiglia Genius e si caratterizza per un design che minimizza ulteriormente lo spessore della parte superiore, riducendolo a soli 50 mm.

Il consueto foro di 20 mm, eroga 540 lm e permette accesso diretto per interventi di manutenzione, grazie a un nuovo sistema che facilita estrazione e sostituzione, senza necessità di alcuna botola e tantomeno di interventi invasivi in caso di manutenzione.

GENIUS IN A THICKNESS OF JUST 60 mm.

A totally recessed luminaire with body in Coral[®], ideal for indoor ceiling-mounted applications.

Genius Basic Flat is the most compact of the Genius family characterised by a design which further minimises the thickness of the upper part, reducing it to only 50 mm (2").

The usual 20 mm (0.79") light emission hole provides 540 lm and allows direct access for maintenance work, thanks to a new system which makes removal and replacement easy, so there is no need for any inspection hatch, nor for invasive maintenance operations.

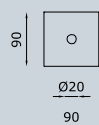

CODE COMPOSITION

1887.00 4 R 24 E _ WD

light colour

27	2700K
30	3000K
40	4000K

1888.00 4 R 24 E _ ND

light colour

27	2700K
30	3000K
40	4000K

example of code composition 1887.00 4 R 24 E **30** WD

TECHNICAL FEATURES

Code	1887.00 XX	1888.00 XX
Type	Downlight 90° 	Downlight 90° 
Material	00: Coral®	00: Coral®
Weight	0.65 Kg	0.65 Kg
Mounting	Ceiling recessed	Ceiling recessed
IP rating	IP20	IP20
Insulation class	III	III
Control gear	Remote constant current electronic driver (not included)	Remote constant current electronic driver and inverter (included)
Cut out for plasterboard	100 x 100 mm	100 x 100 mm
Lamp type	LED 700 mA  Vf: 6.5 VDC	LED 700 mA 
Lamp wattage	1 x 4.5W	1 x 4.5W
Luminous efficacy	540 lm - 3000K	540 lm - 3000K
Light distribution	Wide beam 24°	Wide beam 24°
Fitting	-	-
Light colour	White 3000K White 2700K 4000K (on request)	White 3000K White 2700K 4000K (on request)
Light hole	Ø 20 mm	Ø 20 mm
Voltage connection	By driver (optional)	220-240V · 50/60Hz
CRI	>90	>90
Emergency	-	1 hour
Energy efficiency class	A++	A++
Note	On request available dimmable PUSH or DALI, remote installation.	On request available dimmable PUSH or DALI, remote installation.

OPTIONAL ACCESSORIES

product code	optional code	description	info
1887.00 XX	H8700.E	Constant current electronic driver. Remote installation	Suitable for n°3 code 1887.00 XX - 700 mA
	BR1887LT	Brick box	Dimensions L: 195 mm; W: 105 mm; D: 110 mm
1888.00 XX	BR1888LT	Brick box	Dimensions L: 195 mm; W: 105 mm; D: 110 mm



GENIUS BASIC SLOPE



GENIUS WALL WASHER IN 80 mm DI SPESSORE.

La variante di Genius Slope destinata al mondo Contract è un prodotto compatto, con possibilità di installazione in intercapedini di soli 80 mm, a soffitto e parete come segnapassi. Genius Basic Slope è un apparecchio da incasso a scomparsa totale per interni, realizzato in Coral® per questa nuova versione. Il foro luce asimmetrico, con asse inclinato di 40°, garantisce una emissione luminosa di 540 lm, con possibilità di effetto wall-washer. La parte elettrica è direttamente estraibile dal foro luce, grazie a un sistema che facilita l'estrazione e la sostituzione della sorgente LED, senza la necessità di alcuna botola di ispezione e tantomeno di interventi invasivi in caso di manutenzione.

GENIUS WALL WASHER IN A THICKNESS OF 80 mm.

The "Slope" version of Genius, designed for the Contract world is a very compact product which can be installed in a cavity measuring only 80 mm (3.15"), ceiling and wall mounted as a path lighter. Genius Basic Slope is a totally recessed luminaire for indoor use, made in Coral® for this new variant. The asymmetrical light emission hole, with a 40° angled axis, guarantees a light emission of 540 lm, with possibility of a wall-washer effect. The electrical part can be removed through the light hole, thanks to a mechanism that makes it easy to pull the LED light source out and replace it, so there is no need for any inspection hatch, nor for invasive maintenance operations.

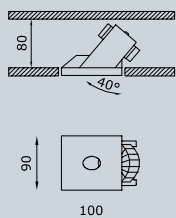

CODE COMPOSITION

1865.00 4 R 24 E _ WD

light colour

27	2700K
30	3000K
40	4000K

1866.00 4 R 24 E _ ND

light colour

27	2700K
30	3000K
40	4000K

example of code composition 1865.00 4 R 24 E **30** WD

TECHNICAL FEATURES

Code	1865.00 XX	1866.00 XX
Type	Downlight 90° 	Downlight 90° 
Material	00: Coral®	00: Coral®
Weight	0.65 Kg	0.65 Kg
Mounting	Ceiling recessed	Ceiling recessed
IP rating	IP20	IP20
Insulation class	III	III
Control gear	Remote constant current electronic driver (not included)	Remote constant current electronic driver and inverter (included)
Cut out for plasterboard	100 x 100 mm	100 x 100 mm
Lamp type	LED 700 mA  Vf: 6.5 VDC	LED 700 mA 
Lamp wattage	1 x 4.5W	1 x 4.5W
Luminous efficacy	540 lm - 3000K	540 lm - 3000K
Light distribution	Wide beam 24°	Wide beam 24°
Fitting	-	-
Light colour	White 3000K White 2700K 4000K (on request)	White 3000K White 2700K 4000K (on request)
Light hole	Ø 20 mm	Ø 20 mm
Voltage connection	By driver (optional)	220-240V · 50/60Hz
CRI	>90	>90
Emergency	-	1 hour
Energy efficiency class	A++	A++
Note	On request available dimmable PUSH or DALI, remote installation.	On request available dimmable PUSH or DALI, remote installation.

OPTIONAL ACCESSORIES

product code	optional code	description	info
1865.00 XX	H8700.E	Constant current electronic driver. Remote installation	Suitable for n°3 code 1865.00 XX - 700 mA
	BR1865LT	Brick box	Dimensions L: 195 mm; W: 140 mm; D: 160 mm
1866.00 XX	BR1866LT	Brick box	Dimensions L: 195 mm; W: 140 mm; D: 160 mm

GENIUS NAKED



UN GENIUS NUDO
ADATTO PER QUALSIASI SUPPORTO E MATERIALE.

Genius Naked è l'evoluzione della famiglia Genius, che estende il concetto di totale integrazione superficiale a qualsiasi materiale e contesto. E' un apparecchio a scomparsa totale, per installazione a soffitto in ambienti interni, che può essere installato su qualsiasi superficie: legno, cemento, specchio, marmo, moduli industriali con uno spessore da 5 mm a massimo 20 mm.

Unica parte visibile è il foro di soli 20 mm, in grado di generare un potente fascio luminoso.

Infatti la variante "Naked" mantiene tutte le prestazioni del Genius, con la parte elettrica estraibile direttamente dal foro luce, grazie alla meccanica push-pull, che facilita l'estrazione e la sostituzione della sorgente LED, senza la necessità di alcuna botola di ispezione e tantomeno di interventi invasivi in caso di manutenzione.

A BARE GENIUS
SUITABLE FOR ANY SUPPORT AND MATERIAL.

Genius Naked is the evolution of the Genius family, extending the total surface integration concept to any material and context. It is a totally recessed luminaire, for ceiling-mounted indoor installation, which can be installed on any surface: wood, cement, mirror, marble, industrial modules with a thickness from 5 mm (0.2") to a maximum of 20 mm (0.79").

The only visible part is the light emission hole of only 20 mm (0.79"), capable of generating a powerful light beam.

In fact, the "Naked" version retains all the performances of the Genius, with the electrical part which can be removed through the light hole, thanks to a push-pull mechanism making it easy to pull the LED light source out and replace it, with no need for any inspection hatch, nor for invasive maintenance operations.

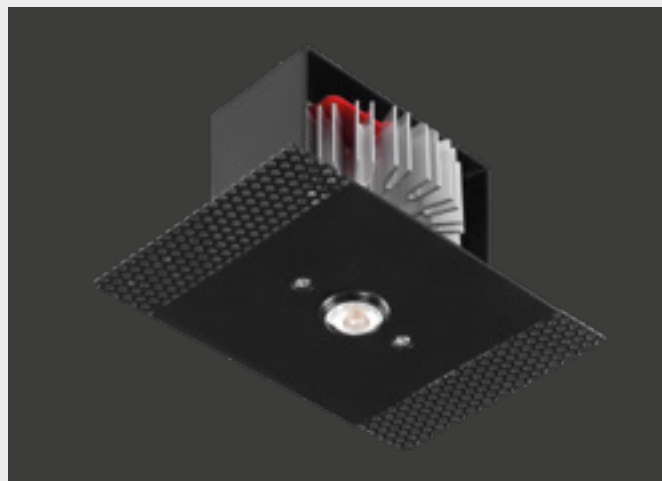

**SCOMPARSATA TOTALE
CON QUALSIASI MATERIALE**

TOTALLY CONCEALED INSTALLATION
WITH ANY MATERIAL



legno / wood



marmo / marble



specchio / mirror

il corpo illuminante viene
pre-montato sul pannello di
rivestimento

*the lighting body is pre-mounted
on the cladding panel*

installabile su materiali con
spessore da 5 a 20 mm

*it can be installed on materials with
a thickness from 5 mm (0.2")
to 20 mm (0.79")*

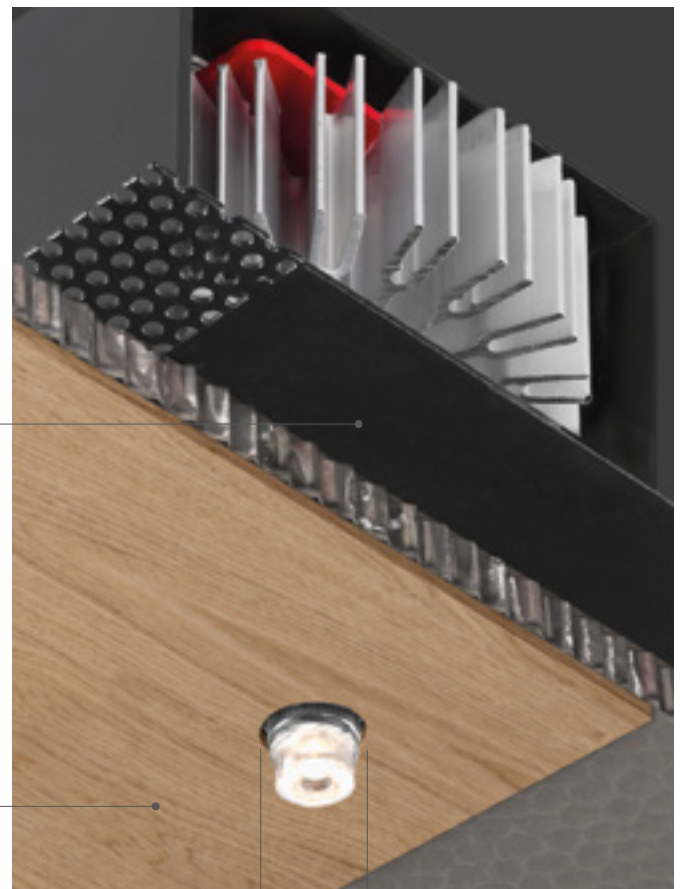

20 mm

l'unica parte visibile è il foro di soli 20 mm

*the only visible part is the emission hole
of 20 mm (0.79")*

PUSH & PULL TECHNOLOGY

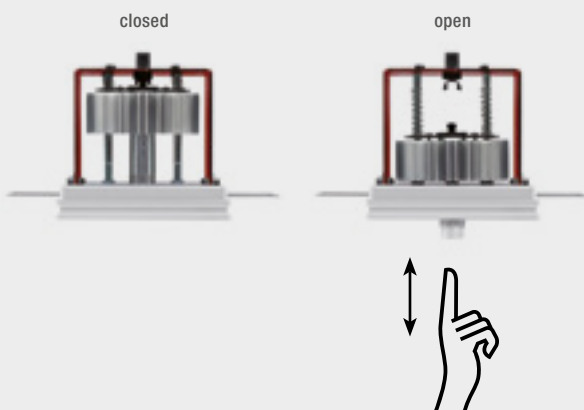

Non necessita di alcuna botola di ispezione. La parte elettrica è estraibile direttamente dal foro luce con un semplice gesto della mano, grazie alla meccanica push-pull, che facilita l'eventuale estrazione e la sostituzione della sorgente LED in caso di manutenzione.

No need for an inspection hatch. The electrical part can be extracted straight from the light hole just with a simple manual gesture, thanks to the push-pull mechanism which makes it easy to extract and replace the LED source for maintenance purposes.

Genius Naked

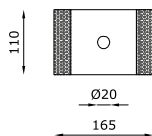
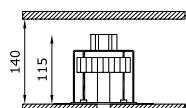

CODE COMPOSITION

1061 BL 4 R 40 E _ WD

light colour

27	2700K
30	3000K
40	4000K

1062 BL 4 R 40 E _ ND





light colour

27	2700K
30	3000K
40	4000K

example of code composition

1061 BL 4 R 40 E **30** WD

TECHNICAL FEATURES

Code	1061 XX	1062 XX
Type	Downlight 90° 	Downlight 90° 
Material	Aluminum I Steel	Aluminum I Steel
Finishing	Black	Black
Weight	0.65 Kg	0.65 Kg
Mounting	Ceiling recessed	Ceiling recessed
IP rating	IP20	IP20
Insulation class	III	III
Control gear	Remote constant current electronic driver (not included)	Remote constant current electronic driver and inverter (included)
Lamp type	LED 700 mA  Vf: 11.5 VDC	LED 700 mA 
Lamp wattage	1 x 8.5W	1 x 8.5W
Luminous efficacy	1000 lm - 3000K	1000 lm - 3000K
Light distribution	Wide beam 40°	Wide beam 40°
Fitting	-	-
Light colour	White 3000K White 2700K I 4000K (on request)	White 3000K White 2700K I 4000K (on request)
Light hole	Ø 20 mm	Ø 20 mm
Voltage connection	By driver (optional)	220-240V · 50/60Hz
CRI	>90	>90
Emergency	-	1 hour
Energy efficiency class	A++	A++
Note	On request available dimmable PUSH or DALI, remote installation. Suitable for installation on surfaces max 20 mm deep. This product could be ordered with IP65 protection grade (see OUTDOOR section - code 2075).	On request available dimmable PUSH or DALI, remote installation. Suitable for installation on surfaces max 20 mm deep. This product could be ordered with IP65 protection grade (see OUTDOOR section - code 2075).

OPTIONAL ACCESSORIES

product code	optional code	description	info
1061 XX	H8700.E	Constant current electronic driver. Remote installation	Suitable for n°1 or n°3 code 1061 XX - 700 mA



Chalet Sauze d'Oulx - AB2ER, Lighting And





Il foyer, Piazza Teatro alla Scala – Michael Vincent Uy MVUY – Milan

TWIN GENIUS NAKED

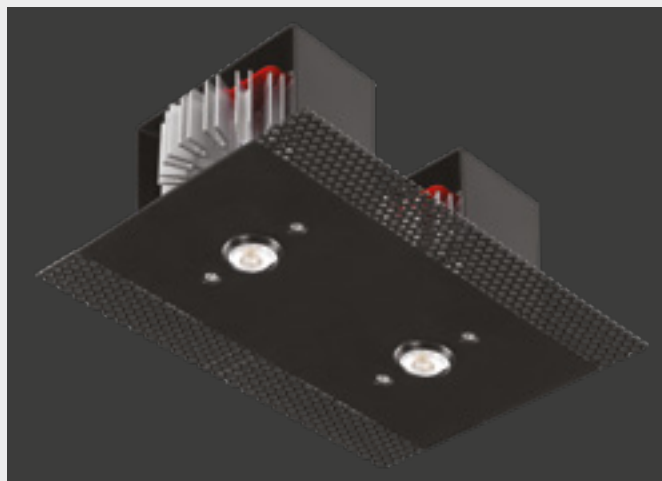

UN GENIUS PER QUALSIASI MATERIALE.

Il design di Genius si raddoppia: Twin Genius, apparecchio da interni a scomparsa totale per installazione a soffitto, che vive ora nella sua versione "Naked", estendendo il concetto di totale integrazione superficiale a qualsiasi materiale e superficie. Dotato di due fori di emissione da soli 20 mm, l'apparecchio scompare completamente quando spento, grazie alla totale integrazione con le superfici in cui è installato: legno, cemento, specchio, marmo, moduli industriali con uno spessore da 5 mm ad un massimo di 20 mm.

L'elettronica mantiene le prestazioni del Genius, con la parte elettrica estraibile direttamente dal foro luce, grazie alla meccanica push-pull, che facilita la sostituzione della sorgente LED, senza la necessità di alcuna botola di ispezione e tantomeno di interventi invasivi in caso di manutenzione.

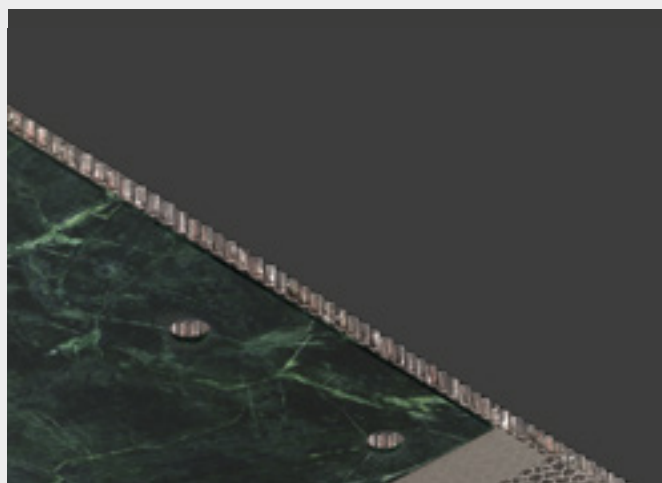

A GENIUS FOR ANY MATERIAL.

The Genius design has been doubled: Twin Genius, a totally recessed indoor luminaire for ceiling mounting, now available in its "Naked" version, extending the total surface integration concept to any material and surface.

Fitted with two light emission holes measuring only 20 mm (0.79"), the luminaire disappears completely when it is switched off, thanks to its total integration with the surfaces on which it is installed: wood, cement, mirror, marble and industrial modules with a thickness from 5 mm (0.2") to a maximum of 20 mm (0.79").

The electronics retain the performances of the Genius, with the electrical part which can be removed through the light hole, thanks to a push-pull mechanism making it easy to pull the LED light source out and replace it, so there is no need for any inspection hatch, nor for invasive maintenance operations.

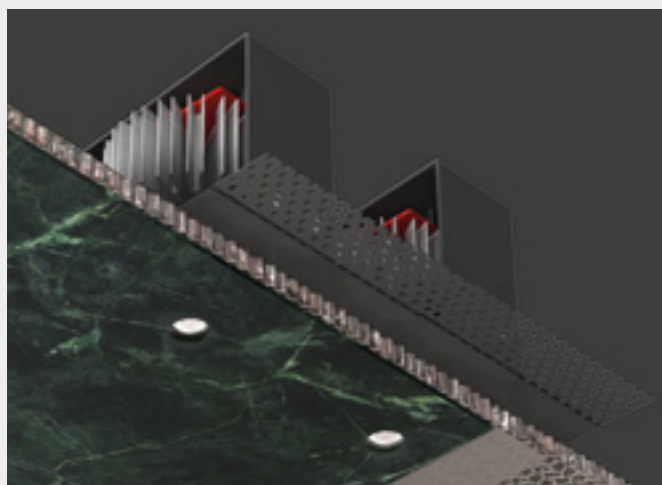

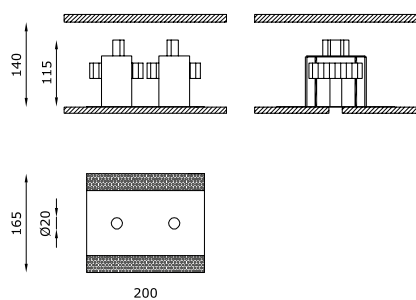

CODE COMPOSITION

1065 BL 4 R 40 E _ WD

light colour

27	2700K
30	3000K
40	4000K



1066 BL 4 R 40 E _ ND

light colour

27	2700K
30	3000K
40	4000K

example of code composition 1065 BL 4 R 40 E 30 WD

TECHNICAL FEATURES

Code	1065 XX	1066 XX
Type	Downlight 90° 	Downlight 90° 
Material	Aluminum I Steel	Aluminum I Steel
Finishing	Black	Black
Weight	1.3 Kg	1.3 Kg
Mounting	Ceiling recessed	Ceiling recessed
IP rating	IP20	IP20
Insulation class	III	III
Control gear	Remote constant current electronic driver (not included)	Remote constant current electronic driver and inverter (included)
Lamp type	LED 700 mA  Vf: 2 x 11.5 VDC	LED 700 mA 
Lamp wattage	2 x 8.5W	2 x 8.5W
Luminous efficacy	2 x 1000 lm - 3000K	2 x 1000 lm - 3000K
Light distribution	Wide beam 40°	Wide beam 40°
Fitting	-	-
Light colour	White 3000K White 2700K I 4000K (on request)	White 3000K White 2700K I 4000K (on request)
Light hole	Ø 20 mm	Ø 20 mm
Voltage connection	By driver (optional)	220-240V · 50/60Hz
CRI	>90	>90
Emergency	-	1 hour
Energy efficiency class	A++	A++
Note	On request available dimmable PUSH or DALI, remote installation. Suitable for installation on surfaces max 20 mm deep.	On request available dimmable PUSH or DALI, remote installation. Suitable for installation on surfaces max 20 mm deep.

OPTIONAL ACCESSORIES

product code	optional code	description	info
1065 XX	H8700.E	Constant current electronic driver. Remote installation	Suitable for n°1 code 1065 XX - 700 mA

GENIUS BASIC NAKED

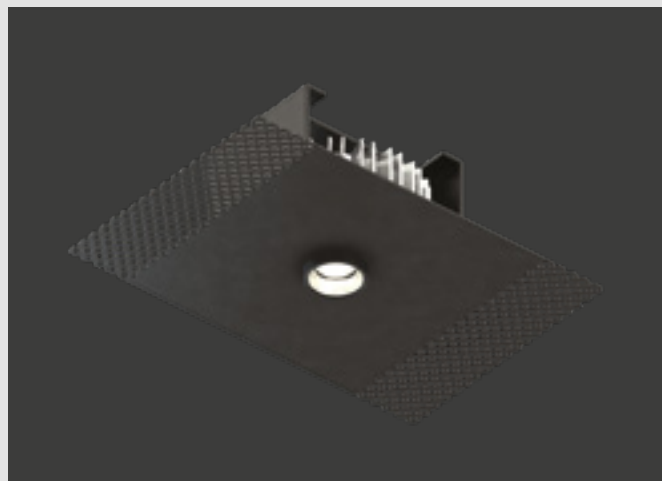

IL PIÙ COMPATTO DA INSTALLARE SU QUALSIASI MATERIALE.

Apparecchio da incasso a scomparsa totale per interni, Genius Basic Naked è una variante di Genius Basic, che unisce alle sue note caratteristiche la possibilità di integrazione superficiale in qualunque contesto e materiale. Questo nuovo Genius non solo estende la consueta affidabilità tecnica di Buzzi & Buzzi al concetto di Contract Business, ma è anche installabile su legno, cemento, specchio, marmo, moduli industriali con uno spessore da 4 mm a massimo 30 mm. Inoltre, questa versione è ancora più compatta ed offre la possibilità di installazione in soli 80 mm di intercapedine.

Genius Basic Naked è la sintesi della tecnologia Buzzi & Buzzi in termini di versatilità ed efficienza: unica parte visibile è il foro di soli 20 mm, da cui eroga un flusso di 540 lm; la parte elettrica è estraibile direttamente dal foro luce, senza necessità di alcuna botola di ispezione e tantomeno di interventi invasivi in caso di manutenzione.

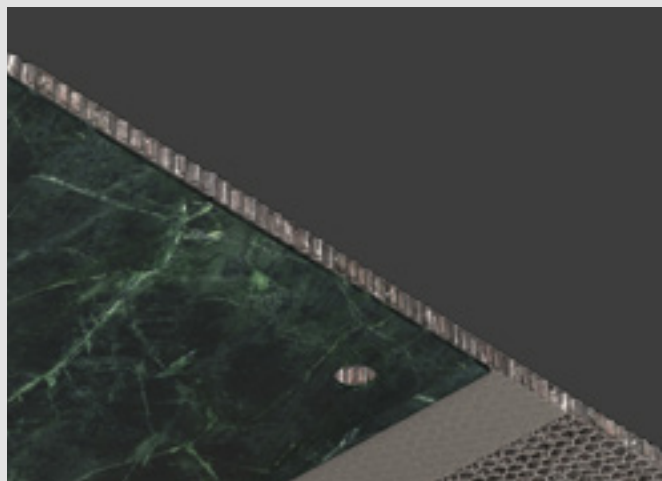

THE MOST COMPACT TO INSTALL ON ANY MATERIAL.

A totally recessed indoor luminaire, Genius Basic Naked is a variation of the Genius Basic, blending its characteristic notes with the possibility of surface integration in any context and material.

Not only does this new Genius extend the usual technical reliability of Buzzi & Buzzi to the Contract Business concept, but it can also be installed on wood, cement, mirror, marble, industrial modules with a thickness of from 4 mm (0.16") to a maximum of 30 mm (1.18").

This version is also more compact and can be installed in a cavity of only 80 mm (3.15").

Genius Basic Naked is the synthesis of Buzzi & Buzzi technology in terms of versatility and efficiency: the only visible part is the light emission hole measuring only 20 mm (0.79"), which provides a light flow of 540 lm; the electrical part can be removed through the light hole, so there is no need for any inspection hatch, nor for invasive maintenance operations.

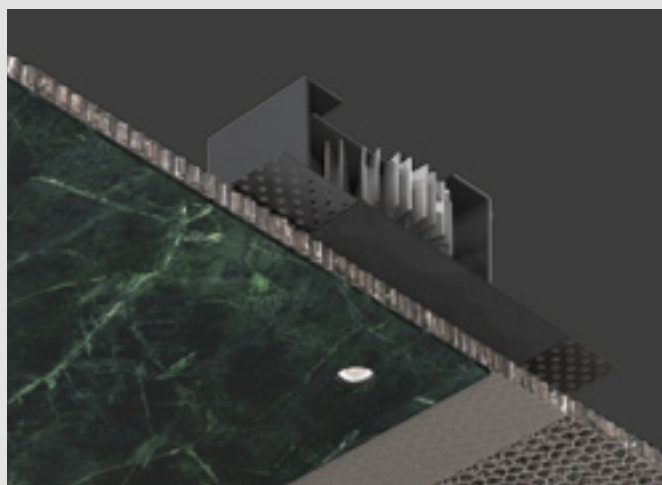

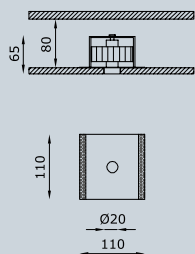

CODE COMPOSITION

1071 BL 4 R 24 E _ WD

light colour

27	2700K
30	3000K
40	4000K

1072 BL 4 R 24 E _ ND





light colour

27	2700K
30	3000K
40	4000K

example of code composition

1071 BL 4 R 24 E **30** WD

TECHNICAL FEATURES

Code	1071 XX	1072 XX
Type	Downlight 90° 	Downlight 90° 
Material	Aluminum I Steel	Aluminum I Steel
Finishing	Black	Black
Weight	0.65 Kg	0.65 Kg
Mounting	Ceiling recessed	Ceiling recessed
IP rating	IP20	IP20
Insulation class	III	III
Control gear	Remote constant current electronic driver (not included)	Remote constant current electronic driver and inverter (included)
Lamp type	LED 700 mA  Vf: 6.5 VDC	LED 700 mA 
Lamp wattage	1 x 4.5W	1 x 4.5W
Luminous efficacy	540 lm - 3000K	540 lm - 3000K
Light distribution	Wide beam 24°	Wide beam 24°
Fitting	-	-
Light colour	White 3000K White 2700K I 4000K (on request)	White 3000K White 2700K I 4000K (on request)
Light hole	Ø 20 mm	Ø 20 mm
Voltage connection	By driver (optional)	220-240V · 50/60Hz
CRI	>90	>90
Emergency	-	1 hour
Energy efficiency class	A++	A++
Note	On request available dimmable PUSH or DALI, remote installation. Suitable for installation on surfaces max 20 mm deep.	On request available dimmable PUSH or DALI, remote installation. Suitable for installation on surfaces max 20 mm deep.
	This product could be ordered with IP65 protection grade (code 2071).	This product could be ordered with IP65 protection grade (code 2072).

OPTIONAL ACCESSORIES

product code	optional code	description	info
1071 XX	H8700.E	Constant current electronic driver. Remote installation	Suitable for n°3 code 1071 XX - 700 mA



GENIUS CONCRETE



LUCE INTEGRATA NEL CEMENTO FACCIA A VISTA.

Genius Concrete è la variante più rivoluzionaria della linea Genius: un apparecchio a scomparsa totale per interni, concepito per superfici in cemento faccia-vista ed installabile durante la fase di getto del calcestruzzo.

Mantiene le prestazioni del Genius, ma ha un corpo lampada semplificato che funziona come cassaforma a perdere, con la parte elettrica estraibile direttamente dal foro luce, grazie ad un nuovo brevetto che permette l'estrazione e la sostituzione della sorgente LED. L'unica apertura visibile è il foro da 23 mm, senza la necessità di alcuna scatola di ispezione ed è installabile per getti con spessore minimo di 12 mm.

INTEGRATED LIGHT IN EXPOSED CEMENT.

Genius Concrete is the most revolutionary version of the Genius line: a totally recessed indoor luminaire, designed for exposed cement surfaces and installable during the concrete casting phase.

It maintains all the performances of the Genius, but has a simplified lamp body which functions as formwork, with the electrical part removable from the light hole, thanks to a new patent which allows the LED light source to be pulled out and replaced.

The only visible aperture is the 23 mm (0.90") outlet, so there is no need for any inspection hatch, and it can be installed with a minimum concrete cover of 12 mm (0.47").

**INSTALLABILE DURANTE LA FASE
DI GETTO DEL CALCESTRUZZO**

INSTALLABLE DURING THE CONCRETE
CASTING PHASE

fissaggio con magnete

magnetic holder

scatola a perdere

disposable box

massima integrabilità con la
superficie (cemento faccia-vista)

*maximum integrability with the
surface (exposed cement)*

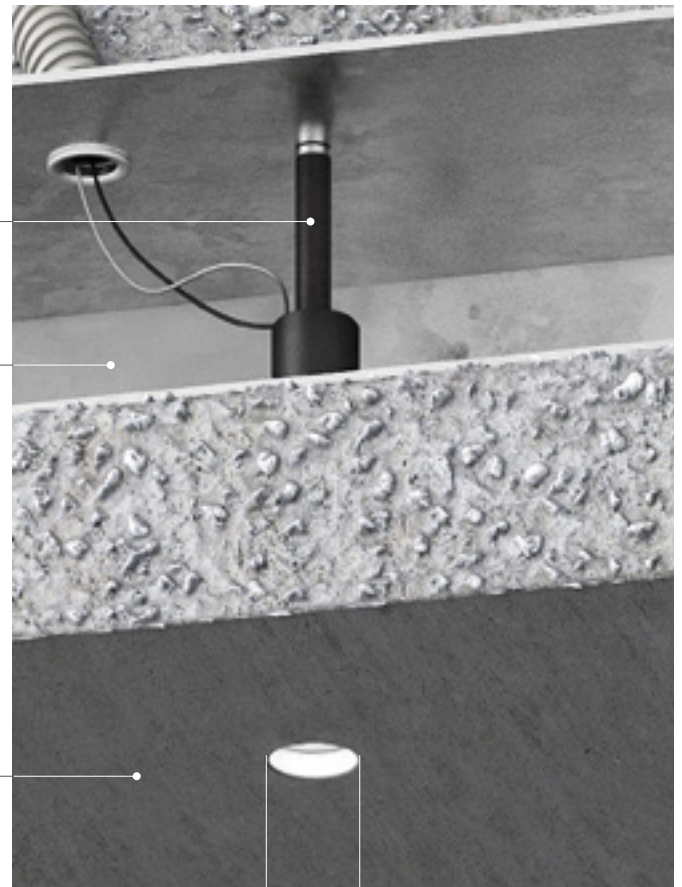

23 mm

l'unica parte visibile è il foro di soli 23 mm

*the only visible part is the emission hole
of 23 mm (0.9")*

INSTALLATION

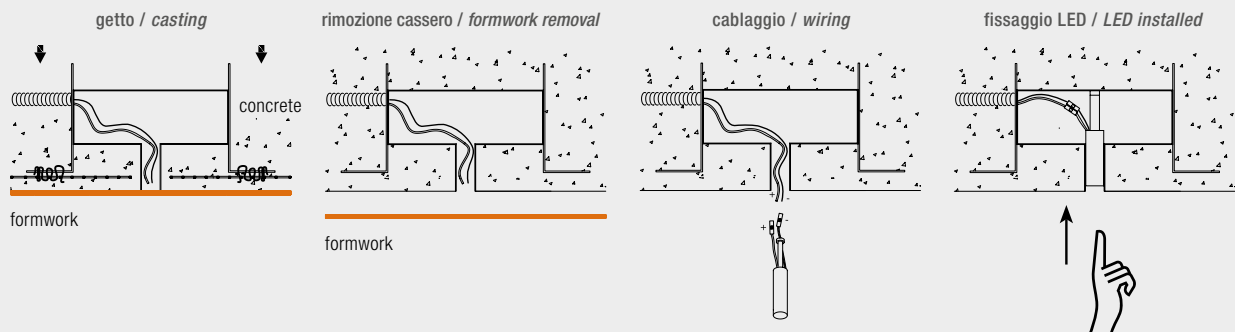

Genius Concrete è installabile durante la fase di getto del calcestruzzo. Grazie ad uno speciale meccanismo, che permette di estrarre la sorgente LED, non sono necessarie botole di ispezione per la manutenzione.

Genius Concrete can be installed during the concrete casting phase. Thanks to a special mechanism which allows the LED source to be extracted, no inspection hatches are required for maintenance purposes.

Genius Concrete

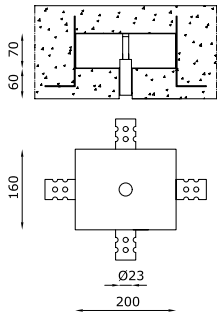

CODE COMPOSITION

1075 BL 4 R 22 E _ WD

light colour

27	2700K
30	3000K
40	4000K

1076 BL 4 R 22 E _ ND



light colour

27	2700K
30	3000K
40	4000K

example of code composition

1075 BL 4 R 22 E **30** WD

TECHNICAL FEATURES

Code	1075 XX	1076 XX
Type	Downlight 90° 	Downlight 90° 
Material	Aluminum	Aluminum
Finishing	Black	Black
Weight	0.4 Kg	0.4 Kg
Mounting	Ceiling recessed	Ceiling recessed
IP rating	IP40	IP40
Insulation class	III	III
Control gear	Remote constant current electronic driver (not included)	Remote constant current electronic driver and inverter (included)
Cut out for plasterboard	-	-
Lamp type	LED 500 mA  Vf: 11.5 VDC	LED 500 mA 
Lamp wattage	1 x 6W	1 x 6W
Luminous efficacy	600 lm - 3000K	600 lm - 3000K
Light distribution	Beam 22°	Beam 22°
Fitting	-	-
Light colour	White 3000K White 2700K 4000K (on request)	White 3000K White 2700K 4000K (on request)
Voltage connection	By driver (optional)	220-240V · 50/60Hz
CRI	>90	>90
Emergency	-	1 hour
Energy efficiency class	A++	A++
Note	On request available dimmable PUSH or DALI.	On request available dimmable PUSH or DALI.

OPTIONAL ACCESSORIES

product code	optional code	description	info
1075 XX	H8500.E	Constant current electronic driver. Remote installation	Suitable for n°3 code 1075 XX - 500 mA



SUPERFUTUREDESIGN™

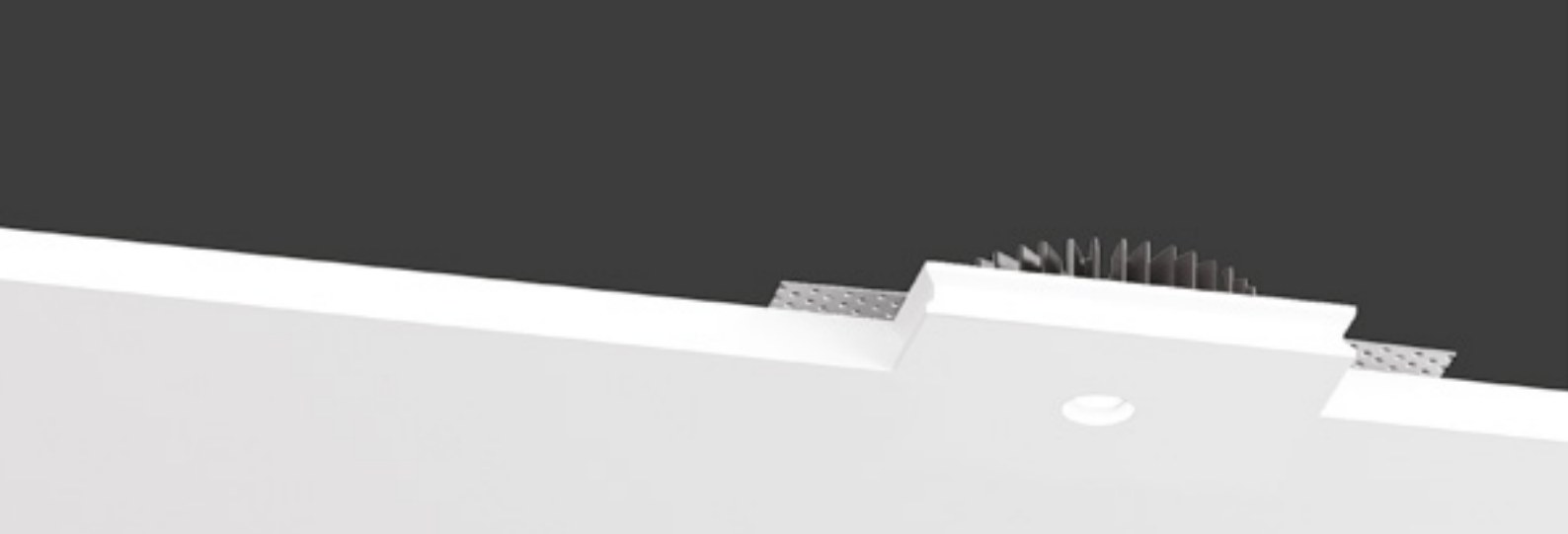

PIXEL



OLTRE 1000 lm IN 35 mm DI INGOMBRO.

Pixel, il nuovo prodotto che si ispira alla famiglia Genius, caratterizzato da linee semplici e raffinate si integra perfettamente nelle superfici in cui viene installato. Lo spazio di installazione si riduce e anche il meccanismo si semplifica. Apparecchio da interni a scomparsa totale in AirCoral® per soffitti in laterizio o cartongesso. La manutenzione della sorgente Led si effettua agevolmente attraverso il foro di emissione luce. Con un diametro di soli 16 mm e un fascio puntuale e scenografico è in grado di creare giochi di luce d'effetto attraverso la sua semplicità tecnica.

MORE THAN 1000 lm IN A SPACE OF 35 mm.

Pixel, the new product inspired by the Genius family and characterized by simple and refined lines, fits perfectly into the surfaces where it is installed. The installation space is reduced and the mechanism is also simplified. Totally disappearing indoor luminaire in AirCoral® for brick or plasterboard ceilings. The LED source maintenance is easily carried out through the emission hole. With its only Ø 16 mm diameter and a punctual and scenographic beam, it's capable of creating impactful light effects through its technical simplicity.

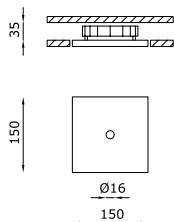

CODE COMPOSITION

1007.AC 4 R _ E _ WD

light colour

27	2700K
30	3000K
40	4000K

lens

15	15°
25	25°
45	45°

example of code composition

1007.AC 4 R 25 E 30 WD

TECHNICAL FEATURES

Code	1007 XX
Type	Downlight 90°
Material	AC: AirCoral®
Absorption capacity*	1.39 m ²
Weight	-
Mounting	Ceiling recessed
IP rating	IP40
Insulation class	III
Control gear	Remote constant current driver (not included)
Cut out for plasterboard	150 x 150 mm
Lamp type	LED 700 mA Vf: 11.5 VDC
Lamp wattage	1 x 8.5W
Luminous efficacy	1000 lm
Light distribution	Narrow beam 15° Beam 25° 45° (on request)
Fitting	-
Light colour	White 3000K White 2700K 4000K (on request)
Light hole	Ø 16 mm
Voltage connection	By driver (optional)
CRI	90
Emergency	-
Energy efficiency class	A++
Note	On request available dimmable PUSH or DALI, remote installation.

OPTIONAL ACCESSORIES

product code	optional code	description	info
1007.AC	H8700.E	Constant current electronic driver. Remote installation	Suitable for n°1 or n°3 code 1007.AC - 700 mA
	BR1007LT	Brick box	Dimensions L: 195 mm; W: 160 mm; D: 120 mm (instructions on page 502)

* The absorption capacity per m² calculated by the American organization TCNA (Tile Council of North America) is measured for an average room of 2.7 m in height and therefore expressed in m²

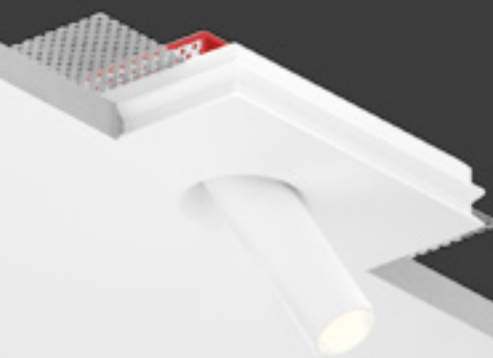

INZETA



PROIETTORE ORIENTABILE A SCOMPARSA.

Inzeta è un apparecchio a incasso a scomparsa totale per interni, con proiettore in alluminio montato semi-recesso su una scocca in AirCoral®, con giunto meccanico invisibile. Inclinabile di 35° e orientabile sull'asse verticale a 360°, Inzeta è caratterizzato dalla qualità della sua luce, con elevata potenza e CRI 90. Un apparecchio miniaturizzato che coniuga le caratteristiche peculiari della scomparsa totale del corpo in AirCoral® con quelle di un proiettore miniaturizzato.

ADJUSTABLE RECESSED PROJECTOR.

Inzeta is a totally recessed luminaire for indoor use, with metal projector half-recessed inside a body made of AirCoral®, with no visible mechanical joints. Inclinabile by 35° and adjustable on the vertical axis at 360°, Inzeta is characterised by the quality of its light, with high power and CRI 90. A miniaturised luminaire which blends the special total-recess characteristics of the AirCoral® body with those of miniaturized projector.

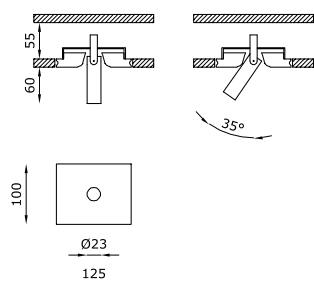

CODE COMPOSITION

184.AC 4 R _ E _ WD

		<i>light colour</i>	
27	2700K		
30	3000K		
40	4000K		
		<i>lens</i>	
22	22°		
50	50°		
		<i>finishing</i>	
6	black		
8	white		

184.AC 4 R _ E _ ND

		<i>light colour</i>	
27	2700K		
30	3000K		
40	4000K		
		<i>lens</i>	
22	22°		
50	50°		
		<i>finishing</i>	
7	black		
9	white		

example of code composition

1846.AC 4 R 22 E 30 WD

TECHNICAL FEATURES

Code	1846.AC XX / 1848.AC XX	1847.AC XX / 1849.AC XX
Type	Tiltable downlight ± 360° / ± 35° 	Tiltable downlight ± 360° / ± 35°
Material	AC: AirCoral®	AC: AirCoral®
Absorption capacity*	1.39 m²	1.39 m²
Finishing	Black I White	Black I White
Weight	0.8 Kg	0.8 Kg
Mounting	Wall and ceiling recessed	Wall and ceiling recessed
IP rating	IP40	IP40
Insulation class	III	III
Control gear	Remote constant current electronic driver (not included)	Remote constant current electronic driver and inverter (included)
Cut out for plasterboard	135 x 110 mm	135 x 110 mm
Lamp type	LED 500 mA Vf: 11.5 VDC	LED 500 mA
Lamp wattage	1 x 6W	1 x 6W
Luminous efficacy	600 lm - 3000K	600 lm - 3000K
Light distribution	Beam 22° Beam 50° (on request)	Beam 22° Beam 50° (on request)
Fitting	-	-
Light colour	White 3000K White 2700K I 4000K (on request)	White 3000K White 2700K I 4000K (on request)
Light hole	Ø 23 mm	Ø 23 mm
Voltage connection	By driver (optional)	220-240V · 50/60Hz
CRI	>90	>90
Emergency	-	1 hour
Energy efficiency class	A++	A++
Note	On request available dimmable PUSH or DALI.	On request available dimmable PUSH or DALI.

OPTIONAL ACCESSORIES

product code	optional code	description	info
1846.AC XX / 1848.AC XX	H8500.E	Constant current electronic driver. Remote installation	Suitable for n°3 code 1846.AC XX / 1848.AC XX - 500 mA



SUPERFUTUREDESIGN*





RHINO



ESTRAIBILE E ORIENTABILE.

Rhino, apparecchio da interni in Coral® per installazione a soffitto o parete di cartongesso, è un prodotto versatile e funzionale, caratterizzato da un incasso a scomparsa totale e un faretto estraibile e direzionabile, dotato di lenti intercambiabili. Rhino è in grado di illuminare gli ambienti in modo determinante, arricchendoli semplicemente grazie a giochi di luce spot e sempre diversi. Il proiettore può essere posizionato in diversi modi dalla posizione completamente esterna a retrocessa. Quest'ultima posizione è studiata per avere il minimo impatto visivo. Quando non recesso è orientabile di 360° sull'asse orizzontale e 90° sull'asse verticale.

EXTRACTABLE AND ADJUSTABLE.

Rhino, an indoor totally disappearing recessed luminaire made of Coral®, installable on plasterboard ceilings or walls, is a versatile product, characterized by an extractable recess with interchangeable lens. It enlightens spaces perfectly and in a very incisive way, enriching them with ever-changing plays of light. The projector can be oriented in several ways, in a completely external position or in a recessed one. The latter, conceived to obtain a minimal visual impact. When the projector is not recessed it is 360° adjustable on the horizontal line and 90° on the vertical one.

Recessed

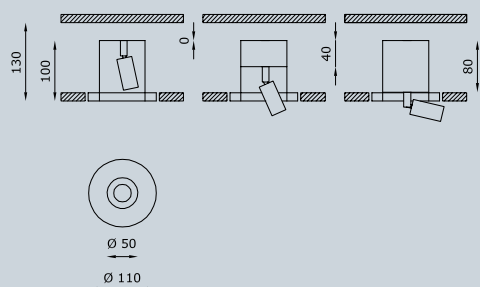

TECHNICAL FEATURES

Code	1841.00	1843.00
Type	Tilttable downlight $\pm 360^\circ / \pm 90^\circ$ 	Tilttable downlight $\pm 360^\circ / \pm 90^\circ$
Material	00: Coral®	00: Coral®
Finishing	Black	White
Weight	0.8 Kg	0.8 Kg
Mounting	Wall and ceiling recessed	Wall and ceiling recessed
IP rating	IP40	IP40
Insulation class	III	III
Control gear	Constant current electronic driver (not included)	Constant current electronic driver (not included)
Cut out for plasterboard	$\varnothing 120$ mm	$\varnothing 120$ mm
Lamp type	LED 500 mA Vf: 11 VDC	LED 500 mA Vf: 11 VDC
Lamp wattage	1 x 6W	1 x 6W
Luminous efficacy	520 lm - 3000K	520 lm - 3000K
Light distribution	Beam 22° Beam 50° (on request)	Beam 22° Beam 50° (on request)
Fitting	-	-
Light colour	White 3000K White 2700K 4000K (on request)	White 3000K White 2700K 4000K (on request)
Light hole	$\varnothing 50$ mm	$\varnothing 50$ mm
Voltage connection	By driver (optional)	By driver (optional)
CRI	>90	>90
Emergency	-	-
Energy efficiency class	A++	A++
Note	On request available dimmable PUSH or DALI.	On request available dimmable PUSH or DALI.

OPTIONAL ACCESSORIES

product code	optional code	description	info
1841.00 / 1843.00	H8500.E	Constant current electronic driver. Remote installation	Suitable for n°3 code 1841.00 / 1843.00 - 500 mA
	H8500.C	Constant current electronic driver	Suitable for n°1 code 1841.00 / 1843.00 - 500 mA



Showroom - Dubai





TAURUS



ESTRAIBILE ED ORIENTABILE
CON 1, 2, O 3 PUNTI LUCE, BIANCO O NERO.

Taurus, apparecchio da interni per installazione a soffitto o parete di cartongesso, dotato di incasso in Coral® e faretto estraibile, evidenzia con precisione ed eleganza ogni dettaglio dello spazio progettuale.

Taurus, grazie alla direzionalità e all'intercambiabilità delle lenti, risponde con precisione alle necessità di una luce precisa, decisa e concreta.

Il proiettore può essere posizionato in diversi modi, dalla posizione completamente esterna a quella retrocessa. Quest'ultima posizione è studiata per avere il minimo impatto visivo. Quando il proiettore non è retrocesso è orientabile di 360° sull'asse orizzontale e 90° sull'asse verticale. Le dimensioni compatte e il design minimale lo rendono la soluzione ideale per illuminare gli ambienti con discrezione.

EXTRACTABLE AND ADJUSTABLE
WITH 1, 2 OR 3 LIGHT POINTS, BLACK OR WHITE.

Taurus, an indoor totally disappearing luminaire installable on plasterboard ceilings or walls, with a recessed body made of Coral® and an extractable projector, underlines spaces and details with a precise and elegant beam of light. Thanks to the orientable and interchangeable lens, Taurus appropriately answers to the necessity of obtaining a sharp, precise and concrete light. The projector can be oriented in several ways, in a completely external position or in a recessed one. The latter, conceived to obtain a minimal visual impact. When the projector is not recessed it is 360° adjustable on the horizontal line and 90° on the vertical one. The solid forms and the minimal design makes this luminaire perfect for illuminating the environment in a discreet manner.

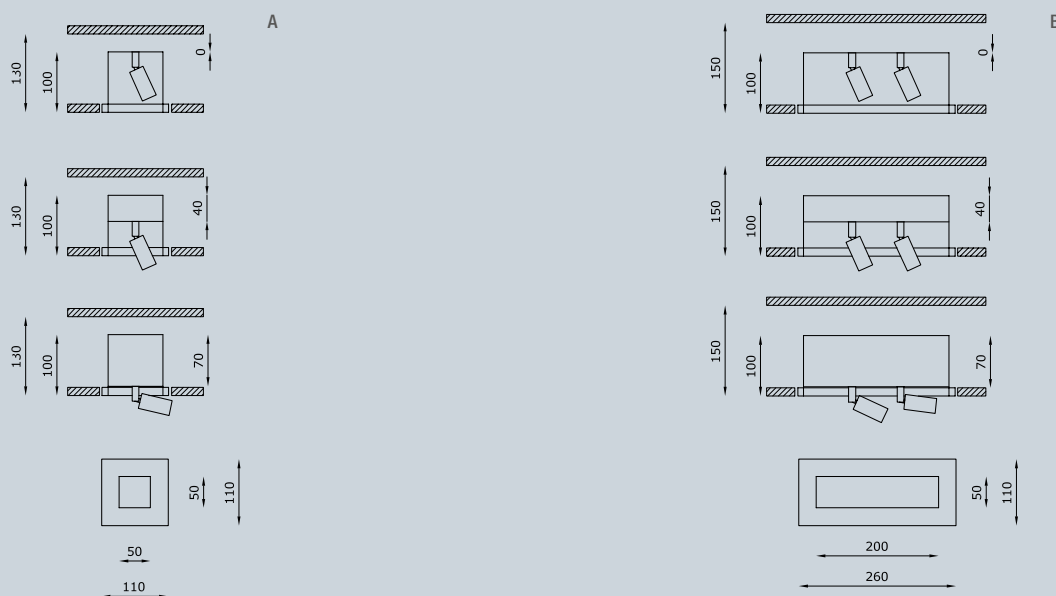

TECHNICAL FEATURES

Code	1831.00 (fig.A)	1834.00 (fig.A)	1832.00 (fig.B)	1835.00 (fig.B)
Type	Tilttable downlight $\pm 360^\circ / \pm 90^\circ$ 	Tilttable downlight $\pm 360^\circ / \pm 90^\circ$ 	Tilttable downlight $\pm 360^\circ / \pm 90^\circ$ 	Tilttable downlight $\pm 360^\circ / \pm 90^\circ$
Material	00: Coral®	00: Coral®	00: Coral®	00: Coral®
Finishing	Black	White	Black	White
Weight	1 Kg	1 Kg	2 Kg	2 Kg
Mounting	Wall and ceiling recessed	Wall and ceiling recessed	Wall and ceiling recessed	Wall and ceiling recessed
IP rating	IP40	IP40	IP40	IP40
Insulation class	III	III	III	III
Control gear	Constant current electronic driver (not included)	Constant current electronic driver (not included)	Constant current electronic driver (not included)	Constant current electronic driver (not included)
Cut out for plasterboard	120 x 120 mm	120 x 120 mm	270 x 120 mm	270 x 120 mm
Lamp type	LED 500 mA Vf: 11 VDC	LED 500 mA Vf: 11 VDC	LED 500 mA Vf: 2 x 11 VDC	LED 500 mA Vf: 2 x 11 VDC
Lamp wattage	1 x 6W	1 x 6W	2 x 6W	2 x 6W
Luminous efficacy	520 lm - 3000K	520 lm - 3000K	2 x 520 lm - 3000K	2 x 520 lm - 3000K
Light distribution	Beam 22° Beam 50° (on request)	Beam 22° Beam 50° (on request)	Beam 22° Beam 50° (on request)	Beam 22° Beam 50° (on request)
Fitting	-	-	-	-
Light colour	White 3000K White 2700K 4000K (on request)	White 3000K White 2700K 4000K (on request)	White 3000K White 2700K 4000K (on request)	White 3000K White 2700K 4000K (on request)
Light hole	50 x 50 mm	50 x 50 mm	50 x 200 mm	50 x 200 mm
Voltage connection	By driver (optional)	By driver (optional)	By driver (optional)	By driver (optional)
CRI	>90	>90	>90	>90
Emergency	-	-	-	-
Energy efficiency class	A++	A++	A++	A++
Note	On request available dimmable PUSH or DALI, remote installation.	On request available dimmable PUSH or DALI, remote installation.	On request available dimmable PUSH or DALI.	On request available dimmable PUSH or DALI.

OPTIONAL ACCESSORIES

product code	optional code	description	info
1831.00 / 1834.00	H8500.E	Constant current electronic driver. Remote installation	Suitable for n°3 code 1831.00 / 1834.00 - 500 mA
	H8500.C	Constant current electronic driver	Suitable for n°1 code 1831.00 / 1834.00 - 500 mA
1832.00 / 1835.00	H8500.E	Constant current electronic driver	Suitable for n°1 code 1832.00 / 1835.00 - 500 mA



SUPERFUTUREDESIGN™

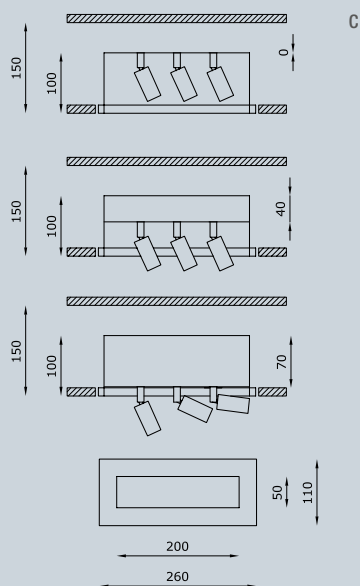

TECHNICAL FEATURES

Code	1833.00 (fig.C)	1836.00 (fig.C)
Type	Tilttable downlight $\pm 360^\circ / \pm 90^\circ$ 	Tilttable downlight $\pm 360^\circ / \pm 90^\circ$
Material	00: Coral®	00: Coral®
Finishing	Black	White
Weight	2.1 Kg	2.1 Kg
Mounting	Wall and ceiling recessed	Wall and ceiling recessed
IP rating	IP40	IP40
Insulation class	III	III
Control gear	Constant current electronic driver (not included)	Constant current electronic driver (not included)
Cut out for plasterboard	270 x 120 mm	270 x 120 mm
Lamp type	LED 500 mA Vf: 3 x 11 VDC	LED 500 mA Vf: 3 x 11 VDC
Lamp wattage	3 x 6W	3 x 6W
Luminous efficacy	3 x 520 lm - 3000K	3 x 520 lm - 3000K
Light distribution	Beam 22° Beam 50° (on request)	Beam 22° Beam 50° (on request)
Fitting	-	-
Light colour	White 3000K White 2700K 4000K (on request)	White 3000K White 2700K 4000K (on request)
Light hole	50 x 200 mm	50 x 200 mm
Voltage connection	By driver (optional)	By driver (optional)
CRI	>90	>90
Emergency	-	-
Energy efficiency class	A++	A++
Note	On request available dimmable PUSH or DALI.	On request available dimmable PUSH or DALI.

OPTIONAL ACCESSORIES

product code	optional code	description	info
1833.00 / 1836.00	H8500.E	Constant current electronic driver	Suitable for n°1 code 1833.00 / 1836.00 - 500 mA





Private villa - Arch. E.Corti - Cap Ferrat Côte d'Azur



BULL



ESTRAIBILE DALL'INCASSO E ORIENTABILE.

Un occhio puntato su un elemento da valorizzare, su un arredo da enfatizzare: Bull, apparecchio da interni a scomparsa totale per installazione a soffitto di cartongesso, è composto da un incasso in Coral[®], una cassa posteriore nera in acciaio completa di proiettore orientabile, che può essere estratto dall'incasso per un puntamento preciso del fascio luminoso. Il proiettore in posizione arretrata è studiato per avere il minimo impatto visivo, è orientabile di 360° sull'asse orizzontale e di 90° sull'asse verticale, inoltre ha la possibilità di ottiche intercambiabili. Illuminare con Bull vuol dire dare risalto a precisi elementi, definendo gli spazi e stabilendo nuove prospettive.

ADJUSTABLE AND EXTRACTABLE FROM RECESSED FITTING.

An eye focused on an element to be enhanced, on a decor to be exalted: Bull, an indoor totally disappearing recessed luminaire, installable on plasterboard ceilings, is composed by a Coral[®] body, a rear black-coloured steel case provided with an adjustable spotlight, which can be extracted from the recess in order to redirect luminescent beams in a more precise way. The rear spotlight, designed for having a minimal visual impact, is 360° orientable on the horizontal line and 90° on the vertical one. With Bull, lighting means giving prominence to precise elements, defining spaces and setting new interchangeable optical perspectives.

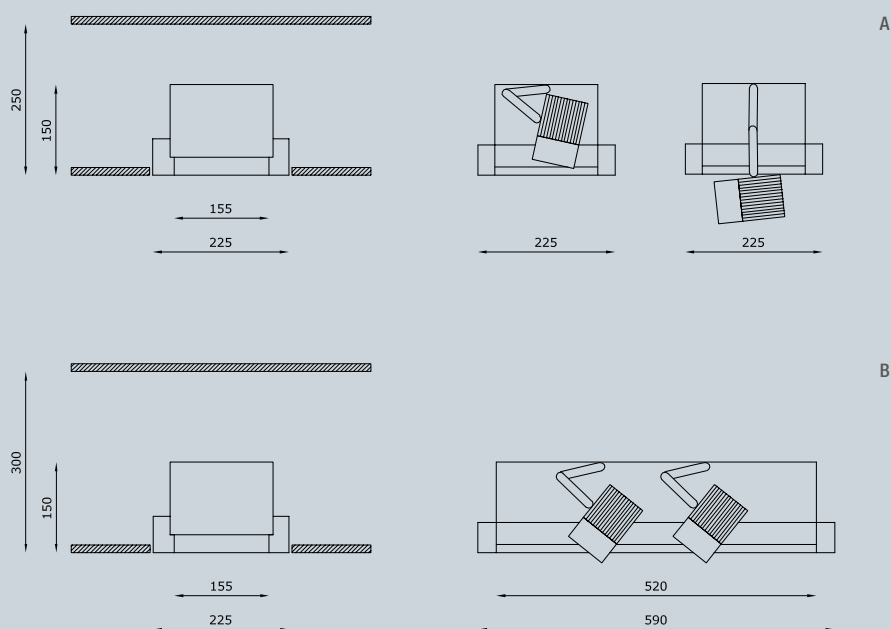

TECHNICAL FEATURES

Code	1811.00 (fig.A)	1812.00 (fig.B)
Type	Tiltable downlight $\pm 360^\circ / \pm 90^\circ$ 	Tiltable downlight $\pm 360^\circ / \pm 90^\circ$
Material	00: Coral®	00: Coral®
Weight	4.5 Kg	7 Kg
Mounting	Ceiling recessed	Ceiling recessed
IP rating	IP40	IP40
Insulation class	III	III
Control gear	Constant current electronic driver (not included)	Constant current electronic driver (not included)
Cut out for plasterboard	235 x 235 mm	235 x 600 mm
Lamp type	LED 700 mA Vf: 37 VDC	LED 700 mA Vf: 2 x 37 VDC
Lamp wattage	1 x 26W	2 x 26W
Luminous efficacy	3500 lm - 3000K	2 x 3500 lm - 3000K
Light distribution	Beam 24° Beam 38° (on request)	Beam 24° Beam 38° (on request)
Fitting	-	-
Light colour	White 3000K White 2700K 4000K (on request)	White 3000K White 2700K 4000K (on request)
Light hole	155 x 155 mm	155 x 520 mm
Voltage connection	By driver (optional)	By driver (optional)
CRI	>90	>90
Emergency	-	-
Energy efficiency class	A++	A++
Note	On request available dimmable PUSH or DALI.	On request available dimmable PUSH or DALI.

OPTIONAL ACCESSORIES

product code	optional code	description	info
1811.00	H8730	Constant current electronic driver	You need n°1 code H8730 for n°1 code 1811.00 - 700 mA
1812.00	H8730	Constant current electronic driver	You need n°2 code H8730 for n°1 code 1812.00 - 700 mA



SUPERFUTUREDESIGN™

C

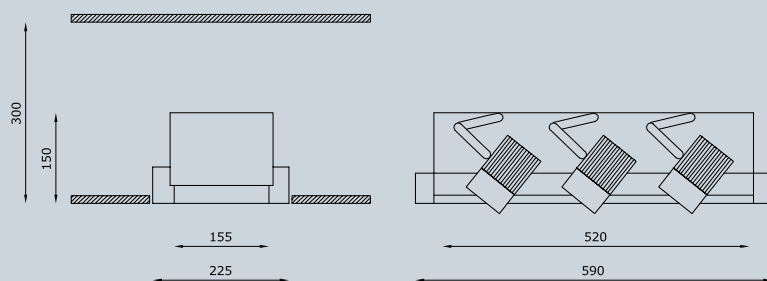

TECHNICAL FEATURES

Code	1813.00 (fig.C)
Type	Tiltable downlight $\pm 360^\circ / \pm 90^\circ$ 
Material	00: Coral®
Weight	10 Kg
Mounting	Ceiling recessed
IP rating	IP40
Insulation class	III
Control gear	Constant current electronic driver (not included)
Cut out for plasterboard	235 x 600 mm
Lamp type	LED 700 mA  Vf: 3 x 37 VDC
Lamp wattage	3 x 26W
Luminous efficacy	3 x 3500 lm - 3000K
Light distribution	Beam 24° Beam 38° (on request)
Fitting	-
Light colour	White 3000K White 2700K 4000K (on request)
Light hole	155 x 520 mm
Voltage connection	By driver (optional)
CRI	>90
Emergency	-
Energy efficiency class	A++
Note	On request available dimmable PUSH or DALI.

OPTIONAL ACCESSORIES

product code	optional code	description	info
1813.00	H8730	Constant current electronic driver	You need n°3 code H8730 for n°1 code 1813.00 - 700 mA



SLICE



800 lm IN 12.5 mm DI INGOMBRO.

Slice è un apparecchio da incasso a scomparsa totale per interni, che si caratterizza per il design estremamente sottile: 12.5 mm di spessore. Grazie all'assenza di scatole di montaggio, Slice permette installazioni sia a soffitto che a parete, rimanendo all'interno del solo spessore della lastra di cartongesso, o di intonaco. Questo rivoluzionario prodotto da incasso è realizzato in AirCoral® di cui mantiene tutte le caratteristiche di scomparsa totale. L'ottica LED è in grado di emettere 800 lumen. Installabile con driver remoto, permette la manutenzione dal solo lato frontale dell'apparecchio, riducendo al minimo interventi post installazione.

800 lm IN A SPACE OF 12.5 mm.

Slice is a totally recessed luminaire for indoor use, characterised by its extremely slim design: 12.5 mm (0.49") thick. Thanks to the absence of mounting boxes, Slice can be both ceiling and wall mounted, fitted into the thickness of the drywall panel or plaster. This revolutionary recessed product is made in AirCoral® of which it maintains all its total recessed characteristics. The LED optics can emit 800 lumen. Installable with remote driver, maintenance can be carried out only from the front of the luminaire, reducing to the minimum any post-installation operations.

**SCOMPARSATA TOTALE
IN SOLI 12.5 mm**

TOTALLY CONCEALED INSTALLATION
IN JUST 12.5 mm (0.49")

necessita di soli 5 mm per
l'installazione, senza cassaforma

*needs 5 mm (0.2") for installation,
without mounting formwork*

ispezione frontale
per la manutenzione

*front inspection
for maintenance purposes*

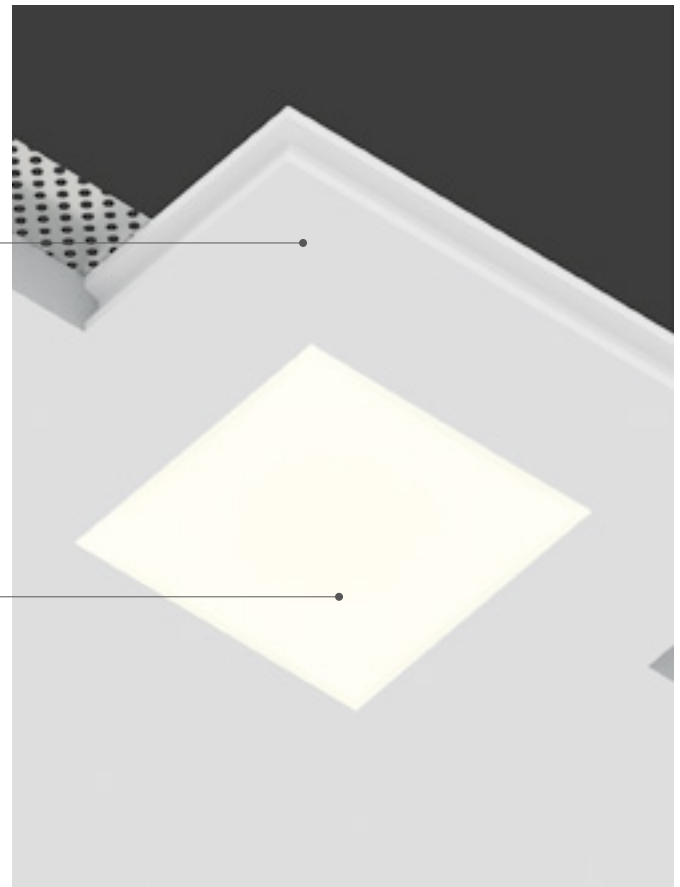

800 lm

elevato output luminoso

high luminous output

MINIMUM REAR SIZE

soli 5 mm per l'installazione
only 5 mm (0.2") for installation

driver remoto

remote constant current driver

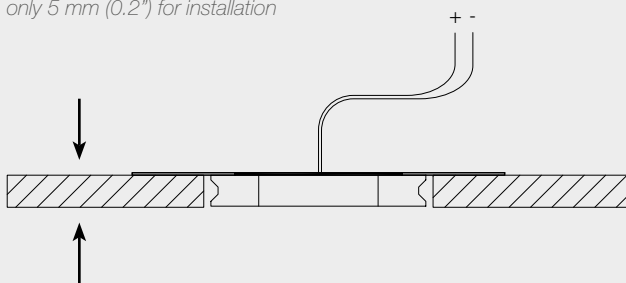

12.5 mm, stesso spessore del cartongesso
12.5 mm (0.49"), same thickness as drywall

Slice necessita di 5 mm per l'installazione, è privo di cassaforma di montaggio ed è installabile all'interno dei soli 12.5 mm di strato di cartongesso. Grazie alla possibilità di ispezione frontale, non è necessaria alcuna botola di controllo.

Slice needs 5 mm (0.2") for installation, is without mounting formwork and can be installed in a layer of drywall just 12.5 mm (0.49") thick. Because it can be inspected from the front it does not need any inspection hatch.

Slice

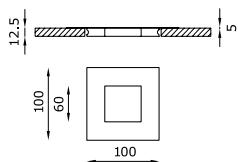

CODE COMPOSITION

1921.AC 4 R 00 E _ WD

light colour

27	2700K
30	3000K
40	4000K

example of code composition 1921.AC 4 R 00 E **27** WD

TECHNICAL FEATURES

Code	1921.AC XX
Type	Downlight 90° 
Material	AC: AirCoral®
Absorption capacity*	1.20 m ²
Weight	0.08 Kg
Mounting	Wall and ceiling recessed
IP rating	IP40
Insulation class	III
Control gear	Remote constant current driver (not included)
Cut out for plasterboard	130 x 130 mm
Lamp type	LED 300 mA Vf: 23.5 VDC
Lamp wattage	1 x 7W
Luminous efficacy	800 lm
Light distribution	Diffuse
Fitting	-
Light colour	White 3000K White 2700K 4000K (on request)
Light hole	60 x 60 mm
Voltage connection	By driver (optional)
CRI	90
Emergency	-
Energy efficiency class	A++
Note	On request available dimmable PUSH or DALI, remote installation.

OPTIONAL ACCESSORIES

<i>product code</i>	<i>optional code</i>	<i>description</i>	<i>info</i>
1921.AC XX	H8300.A	Constant current electronic driver. Remote installation	Suitable for n°1 code 1921.AC XX - 350 mA



SUPERFUTUREDESIGN

Design
Marco Acerbis



BELL



LAMPADA DA INCASSO CON SCURETTO INTEGRATO.

Apparecchio da interni a scomparsa totale in AirCoral® per installazione a soffitto di cartongesso o laterizio. Bell è caratterizzato da una superficie interna stondata e un vuoto perimetrale che crea una contrapposizione tra luce e ombra, presenza e assenza di materia. La sorgente arretrata crea una luce definita ma che allo stesso tempo si distribuisce morbida sia sulla superficie del corpo che nello spazio. Bell, una nuova tipologia di lampada, la cui presenza si rileva sia spenta che accesa e che conferisce una raffinata personalità agli ambienti.

RECESSED LIGHT WITH INTEGRATED SHADE.

An indoor and total disappearing luminaire of AirCoral®, Bell is installable on plasterboard or brick ceilings. It is characterised by an internal, rounded perimetral empty space creating a contrast between light and shadow, of presence and absence of matter. The backward light source casts a sharp beam which, at the same time, scatters softly both on the body surface and in the environment. Bell is a new typology of lamp whose personality is always visible, with the light switched on or off as well. This personality reflects itself in the surrounding environment too.

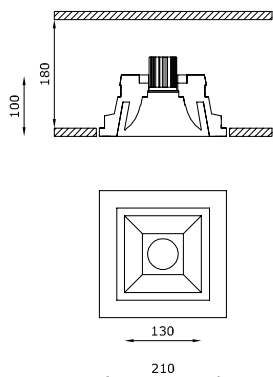

TECHNICAL FEATURES

Code	1901.AC	1902.AC
Type	Downlight 90° 	Downlight 90° 
Material	AC: AirCoral®	AC: AirCoral®
Absorption capacity*	5.69 m ²	5.69 m ²
Weight	2.9 Kg	3 Kg
Mounting	Ceiling recessed	Ceiling recessed
IP rating	IP20	IP20
Insulation class	III	III
Control gear	Constant current electronic driver (not included)	Remote constant current electronic driver and inverter
Cut out for plasterboard	220 x 220 mm	220 x 220 mm
Lamp type	LED 500 mA  Vf: 18 VDC	LED 500 mA 
Lamp wattage	1 x 9W	1 x 9W
Luminous efficacy	1125 lm - 3000K	1125 lm - 3000K
Light distribution	Wide beam 40°	Wide beam 40°
Fitting	-	-
Light colour	White 3000K White 2700K 4000K (on request)	White 3000K White 2700K 4000K (on request)
Light hole	130 x 130 mm	130 x 130 mm
Voltage connection	By driver (optional)	220-240V · 50/60Hz
CRI	>90	>90
Emergency	-	1 hour
Energy efficiency class	A++	A++
Note	On request available dimmable PUSH or DALI, remote installation.	On request available dimmable PUSH or DALI, remote installation.

OPTIONAL ACCESSORIES

product code	optional code	description	info
1901.AC	H8500.E	Constant current electronic driver. Remote installation	Suitable for n°2 code 1901.AC - 500 mA
	H8500.B	Constant current electronic driver	Suitable for n°1 code 1901.AC - 500 mA

* The absorption capacity per m² calculated by the American organization TCNA (Tile Council of North America) is measured for an average room of 2.7 m in height and therefore expressed in m²





Design
Andrea Sensoli

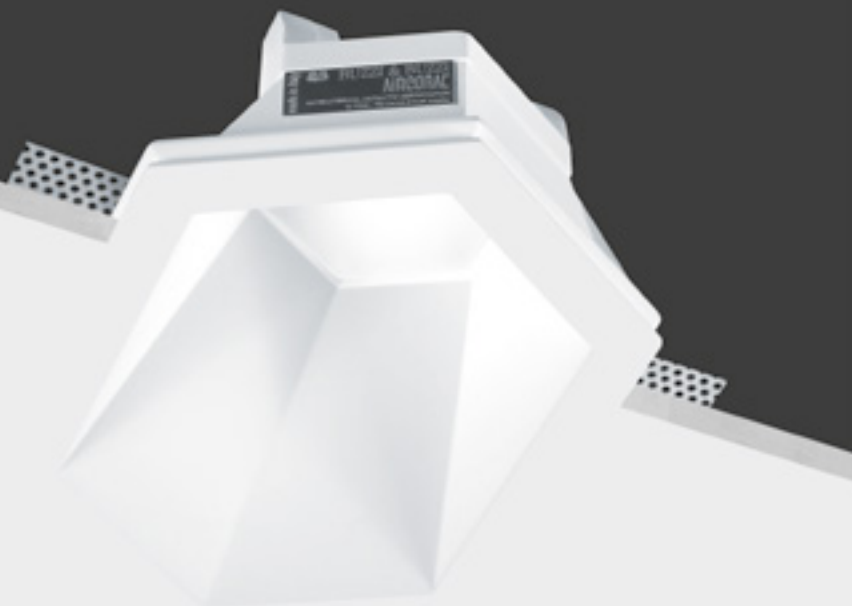

BUZZZ



UN GIOCO DI LUCI E OMBRE A SOFFITTO.

Un prodotto dal design esclusivo e ricercato, in cui eleganza e tecnica si fondono per dare vita ad atmosfere di luce uniche. Un apparecchio da interni in AirCoral®, un incasso a scomparsa totale, per installazione in soffitto di cartongesso o laterizio, che valorizza gli ambienti determinandone l'estetica. Buzzz ha una forma esagonale unica ed un fascio di luce asimmetrico che, uniti al vetro, creano luci suggestive sia sulle sfaccettature del corpo che all'interno dello spazio in cui viene installato. Il connubio tra tecnologia ed emozioni accende l'ambiente di mistero.

A PLAY OF LIGHTS AND SHADES ON THE CEILING.





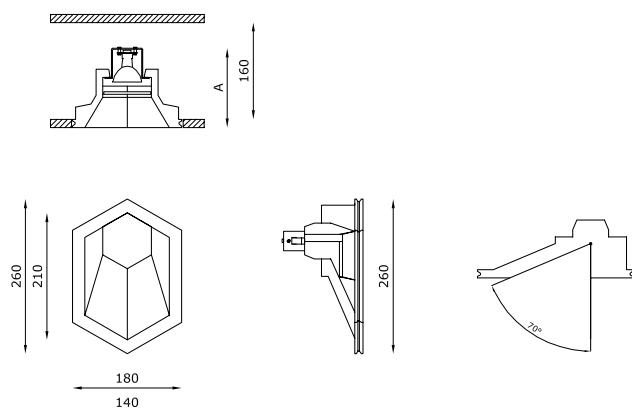

A product with an exclusive and refined design, where elegance and technique are combined to give life to unique light atmospheres. A totally disappearing indoor recessed luminaire made of AirCoral®, installable in plasterboard or brick ceilings, able to enhance environments defining their beauty. Buzzz has a unique hexagonal shape and it emanates asymmetric beams of light which, together with the glass, create suggestive lights both on the sides of the body and within the space it is installed in. This combination of technology and emotions fills the environment with mystery.

Recessed



Restaurant Chef Alessandro Borghese, Il lusso della semplicità
Arch. A. Canelli, Arch. G. Antonelli Dudan - Milan

TECHNICAL FEATURES

Code	6157.Z.AC	6158.Z.AC	6155.AC
Type	Asymmetric downlight 70° 	Asymmetric downlight 70° 	Asymmetric downlight 70° 
Material	AC: AirCoral®	AC: AirCoral®	AC: AirCoral®
Absorption capacity*	4.64 m ²	4.64 m ²	4.64 m ²
Weight	0.9 Kg	0.9 Kg	0.9 Kg
Mounting	Ceiling recessed	Ceiling recessed	Ceiling recessed
IP rating	IP40	IP40	IP40
Insulation class	III	III	III
Control gear	Constant current electronic driver (not included)	Constant current electronic driver	Electronic transformer (not included)
Dimensions	A: 140 mm	A: 140 mm	A: 130 mm
Cut out for plasterboard	see instructions	see instructions	see instructions
Lamp type	LED 500 mA  Vf: 18 VDC	LED 500 mA 	QR CB 51 
Lamp wattage	1 x 9W	1 x 9W	1 x 50W max
Luminous efficacy	1125 lm - 3000K	1125 lm - 3000K	-
Light distribution	Wide beam 40°	Wide beam 40°	-
Fitting	-	-	GU5.3
Light colour	White 3000K White 2700K 4000K (on request)	White 3000K White 2700K 4000K (on request)	-
Light hole	210 x 140 mm	210 x 140 mm	210 x 140 mm
Voltage connection	By driver (optional)	220-240V · 50/60Hz	By driver (optional)
CRI	>90	>90	-
Emergency	-	1 hour	-
Energy efficiency class	A++	A++	A
Note	Extra white satin glass. Frosted glass recessed 50 mm into the ceiling. On request available dimmable PUSH or DALI.	Extra white satin glass. Frosted glass recessed 50 mm into the ceiling. On request available dimmable PUSH or DALI.	Extra white satin glass. Frosted glass recessed 50 mm into the ceiling.

OPTIONAL ACCESSORIES

product code	optional code	description	info
6157.Z.AC	H8500.E	Constant current electronic driver	Suitable for n°2 code 6157.Z.AC - 500 mA
	H8500.B	Constant current electronic driver	Suitable for n°1 code 6157.Z.AC - 500 mA
6155.AC	H8060.LED 0008KIT	Dimmable electronic transformer Kit LED dimmable	Max watt 60W Volts · Hz 230/12V · 50/60Hz Bulb 7W · 12V

* The absorption capacity per m² calculated by the American organization TCNA (Tile Council of North America) is measured for an average room of 2.7 m in height and therefore expressed in m²



Restaurant Chef Alessandro Borghese, Il lusso della semplicità - Arch. A. Canelli Arch. G. Antonelli Dudan - Milan



Private house - ASZ Architetti - Dubai



Restaurant Chef Alessandro Borghese, Il lusso della semplicità - Arch. A. Canelli, Arch. G. Antonelli Dudan - Milan



Design

Stefano Dall'Osso



EGGY



UNA SOLUZIONE ARRETRATA ANTIABBAGLIAMENTO.

Incasto in AirCoral® a scomparsa totale a tecnologia LED per installazione a soffitto di cartongesso o laterizio che, grazie alla sua forma, può essere utilizzato in ogni tipologia di ambiente e si presta ad un'interpretazione progettuale visionaria e dal forte impatto visivo. Con Eggy, la funzionalità di un'illuminazione discreta, avvolgente e ben distribuita, si sposa con la componente emozionale dove la forma dell'uovo si staglia sul soffitto creando una suggestione visiva. Grazie alla meccanica push-pull è possibile estrarre la parte elettrica ed avere un prodotto senza viti o molle a vista per il fissaggio della sorgente LED.

A RECESSED ANTI-DAZZLE SOLUTION.

A LED technology totally disappearing recessed luminaire made of AirCoral®, installable on plasterboard or brick ceilings that, thanks to its ovoid shape, can be used in any kind of environment and is suitable for a visionary project interpretation, with a strong visual impact. With Eggy, the functionality of a discreet illumination, embracing and well-distributed, is combined with the emotional elements, as the egg shape stands out on the ceiling creating a visual fascination. Thanks to the push-pull mechanism, it is possible to extract the electric part obtaining a product without screws or visible springs for the fixing of the LED source.

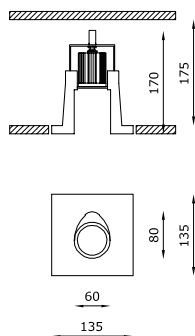

TECHNICAL FEATURES

Code	6498.AC
Type	Asymmetric beam 40° 
Material	AC: AirCoral®
Absorption capacity*	3 m ²
Weight	1.3 Kg
Mounting	Ceiling recessed
IP rating	IP20
Insulation class	III
Control gear	Constant current electronic driver (not included)
Cut out for plasterboard	145 x 145 mm
Lamp type	LED 500 mA ☑ Vf: 18 VDC
Lamp wattage	1 x 9W
Luminous efficacy	1125 lm - 3000K
Light distribution	Wide beam 40°
Fitting	-
Light colour	White 3000K White 2700K 4000K (on request)
Light hole	Ovoid 80 x 60 mm
Voltage connection	By driver (optional)
CRI	>90
Emergency	-
Energy efficiency class	A++
Note	On request available dimmable PUSH or DALI. On request available emergency.

OPTIONAL ACCESSORIES

<i>product code</i>	<i>optional code</i>	<i>description</i>	<i>info</i>
6498.AC	H8500.E	Constant current electronic driver. Remote installation	Suitable for n°2 code 6498.AC - 500 mA
	H8500.B	Constant current electronic driver	Suitable for n°1 code 6498.AC - 500 mA
	BR6498LT	Brick box	Dimensions L: 195 mm; W: 150 mm; D: 200 mm (<i>instructions on page 502</i>)

* The absorption capacity per m³ calculated by the American organization TCNA (Tile Council of North America) is measured for an average room of 2.7 m in height and therefore expressed in m²



Restaurant Chef Alessandro Borghese, Il lusso della semplicità - Arch. A. Canelli, Arch. G. Antonelli Dudan - Milan

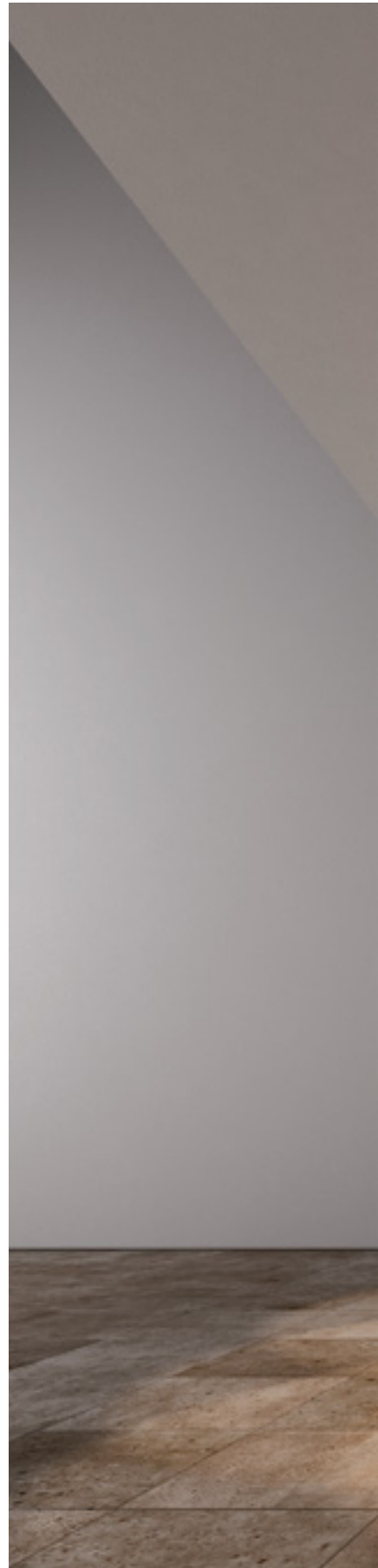







DRY



INCASSO QUADRATO A PARETE, MINIMO INGOMBRO.

Creare percorsi luminosi ricchi di stile, valorizzare gli ambienti, enfatizzare dettagli: Dry, apparecchio da interni a scomparsa totale in AirCoral® per installazione in parete di cartongesso o laterizio, è la soluzione perfetta per chi vuole illuminare i propri spazi, prestando un'attenzione particolare al design e all'eleganza.

SQUARE RECESSED WALL FITTING, MINIMUM DIMENSIONS.

Creating stylish light paths, enhancing rooms, highlighting details: Dry, a totally disappearing luminaire made of AirCoral®, installable on plasterboard or brick walls, is the perfect solution to light spaces up, with particular attention to design and elegance.



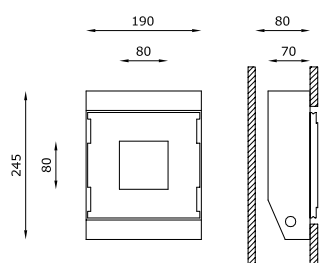

A. DRY 8X8

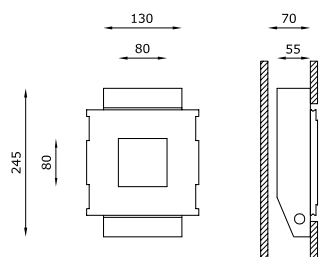

B. DRY MICRO 8X8
for minimal dimensions

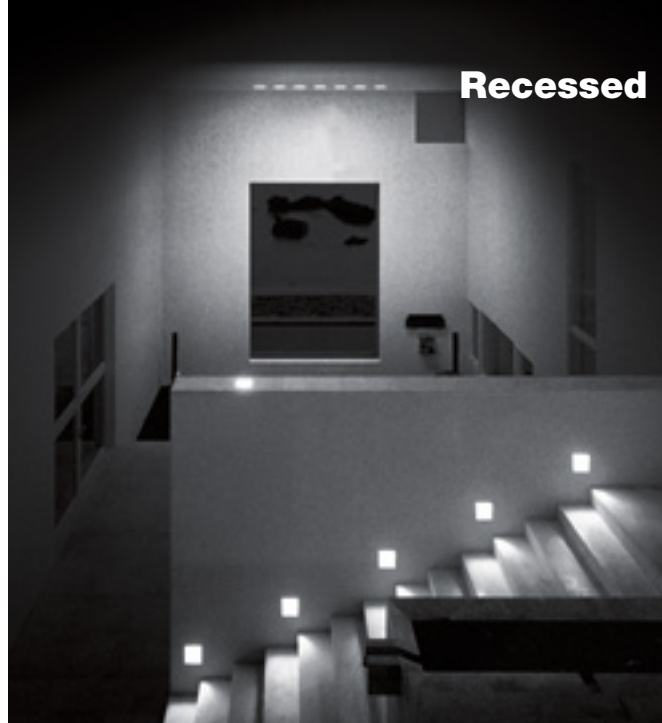

TECHNICAL FEATURES

Code	6111.AC (fig. A)	6112.AC (fig. A)	6113.Z.AC (fig. A)	6121.AC (fig. B)	6122.AC (fig. B)
Type	Wall recessed 45° 	Wall recessed 90° 	Wall recessed 90° 	Wall recessed 45° 	Wall recessed 90° 
Material	AC: AirCoral®	AC: AirCoral®	AC: AirCoral®	AC: AirCoral®	AC: AirCoral®
Absorption capacity*	2.53 m ²	2.53 m ²	2.53 m ²	2.53 m ²	2.53 m ²
Weight	1.5 Kg	1.5 Kg	1.5 Kg	1.3 Kg	1.3 Kg
Mounting	Wall recessed	Wall recessed	Wall recessed	Wall recessed	Wall recessed
IP rating	IP40	IP40	IP40	IP40	IP40
Insulation class	III	III	III	III	III
Control gear	Dimmable electronic transformer	Dimmable electronic transformer	Constant current electronic driver	Dimmable electronic transformer	Dimmable electronic transformer
Cut out for plasterboard	195 x 185 mm	195 x 185 mm	195 x 185 mm	195 x 185 mm	195 x 185 mm
Lamp type	QR CB 51 	QR CB 51 	LED 500 mA 	QR CB 35 	QR CB 35 
Lamp wattage	1 x 50W max	1 x 50W max	1 x 9W	1 x 35W max	1 x 35W max
Luminous efficacy	-	-	1125 lm - 3000K	-	-
Light distribution	-	-	Wide beam 40°	-	-
Fitting	GU5.3	GU5.3	-	GU4	GU4
Light colour	-	-	White 3000K White 2700K 4000K (on request)	-	-
Light hole	80 x 80 mm	80 x 80 mm	80 x 80 mm	80 x 80 mm	80 x 80 mm
Voltage connection	220-240V / 12V · 50/60Hz	220-240V / 12V · 50/60Hz	220-240V · 50/60Hz	220-240V / 12V · 50/60Hz	220-240V / 12V · 50/60Hz
CRI	-	-	>90	-	-
Emergency	-	-	-	-	-
Energy efficiency class	A	A	A++	A	A
Note	Extra white satin glass fixed by clip on wall level.	Extra white satin glass fixed by clip on wall level.	Extra white satin glass fixed by clip on wall level. On request available dimmable PUSH or DALI.	Extra white satin glass fixed by clip on wall level.	Extra white satin glass fixed by clip on wall level.

OPTIONAL ACCESSORIES

product code	optional code	description	info
6111.AC / 6112.AC	0008KIT	Kit LED dimmable	Bulb 7W - 12V

* The absorption capacity per m² calculated by the American organization TCNA (Tile Council of North America) is measured for an average room of 2.7 m in height and therefore expressed in m²

INVISIBILE



INCASSO A PARETE E SOFFITTO CON VETRO A FILO.

Il nome evoca la caratteristica principale di questo apparecchio: Invisibile 10x10 è un apparecchio da interni in AirCoral®, un incasso per installazione in parete e soffitto di cartongesso o laterizio che si integra completamente con la superficie, raggiungendo uno straordinario risultato di scomparsa totale. Superficie e luce diventano così inscindibili, grazie anche alla presenza del vetro satinato, fissato con viti in polycarbonato bianche e completamente a filo sia con il vetro che con il corpo.







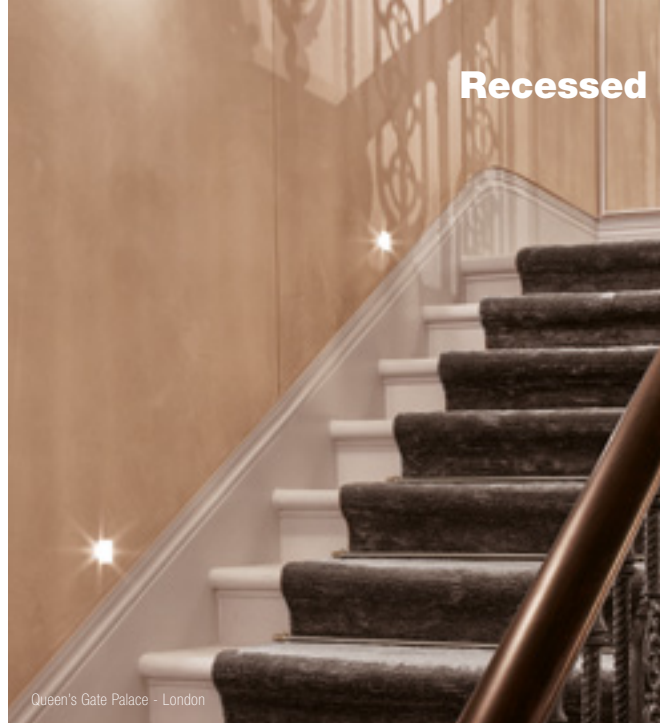
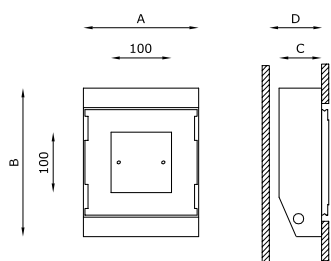

WALL OR CEILING RECESSED FITTING WITH FLUSH GLASS.

Its name evokes the main feature of this product: Invisibile 10x10 is a totally disappearing indoor recessed luminaire made of AirCoral®, installable on plasterboard or brick walls and ceilings, perfectly blending into surfaces, achieving an extraordinary complete disappearance effect. Surface and light become inseparable also thanks to the presence of satin glass, fixed with screws in white polycarbonate which are placed right at the level of both the glass material and the body.





TECHNICAL FEATURES

Code	6131.AC	6132.AC	6133.Z.AC	6139.Z.AC
Type	Downlight 45° Wall recessed 45° 	Downlight 90° Wall recessed 90° 	Downlight 90° Wall recessed 90° 	Downlight 90° Wall recessed 90° 
Material	AC: AirCoral®	AC: AirCoral®	AC: AirCoral®	AC: AirCoral®
Absorption capacity*	2.3 m ²	2.3 m ²	2.3 m ²	2.3 m ²
Weight	1.5 Kg	1.5 Kg	1.5 Kg	1.5 Kg
Mounting	Wall and ceiling recessed	Wall and ceiling recessed	Wall and ceiling recessed	Wall and ceiling recessed
IP rating	IP40	IP40	IP40	IP40
Insulation class	III	III	III	III
Control gear	Dimmable electronic transformer	Dimmable electronic transformer	Constant current electronic driver	Constant current electronic driver
Dimensions	A: 190mm; B: 245mm; C: 70mm; D: 80mm	A: 190mm; B: 245mm; C: 70mm; D: 80mm	A: 190mm; B: 245mm; C: 70mm; D: 80mm	A: 190mm; B: 350mm; C: 70mm; D: 80mm
Cut out for plasterboard	195 x 185 mm	195 x 185 mm	195 x 185 mm	195 x 250 mm
Lamp type	QR CB 51 	QR CB 51 	LED 500 mA 	LED 500 mA 
Lamp wattage	1 x 50W max	1 x 50W max	1 x 9W	1 x 9W
Luminous efficacy	-	-	1125 lm - 3000K	1125 lm - 3000K
Light distribution	-	-	Wide beam 40°	Wide beam 40°
Fitting	GU5.3	GU5.3	-	-
Light colour	-	-	White 3000K White 2700K 4000K (on request)	White 3000K White 2700K 4000K (on request)
Light hole	100 x 100 mm	100 x 100 mm	100 x 100 mm	100 x 100 mm
Voltage connection	220-240V / 12V · 50/60Hz	220-240V / 12V · 50/60Hz	220-240V · 50/60Hz	220-240V · 50/60Hz
CRI	-	-	>90	>90
Emergency	-	-	-	1 hour
Energy efficiency class	A	A	A++	A++
Note	Extra white satin glass fixed by screws on wall/ceiling level.	Extra white satin glass fixed by screws on wall/ceiling level.	Extra white satin glass fixed by screws on wall/ceiling level. On request available dimmable PUSH or DALI.	Extra white satin glass fixed by screws on wall/ceiling level.

OPTIONAL ACCESSORIES

product code	optional code	description	info
6131.AC / 6132.AC	0008KIT	Kit LED dimmable	Bulb 7W - 12V

* The absorption capacity per m² calculated by the American organization TCNA (Tile Council of North America) is measured for an average room of 2.7 m in height and therefore expressed in m²

CLASS



INCASSO A PARETE E SOFFITTO CON VETRO A FILO.

La tecnologia sposa l'eleganza per dare vita a un prodotto dal design pulito e minimale: il corpo in AirCoral® dell'apparecchio, un incasso a scomparsa totale da interni adatto per installazione in parete e soffitto di cartongesso o laterizio, è completamente invisibile. La presenza del vetro satinato, fissato con viti in policarbonato bianche e completamente a filo con il corpo, genera un cono di luce puro e dal volume netto, che avvolge le superfici sottostanti, interrompendo l'oscurità.

WALL OR CEILING RECESSED FITTING WITH FLUSH GLASS.





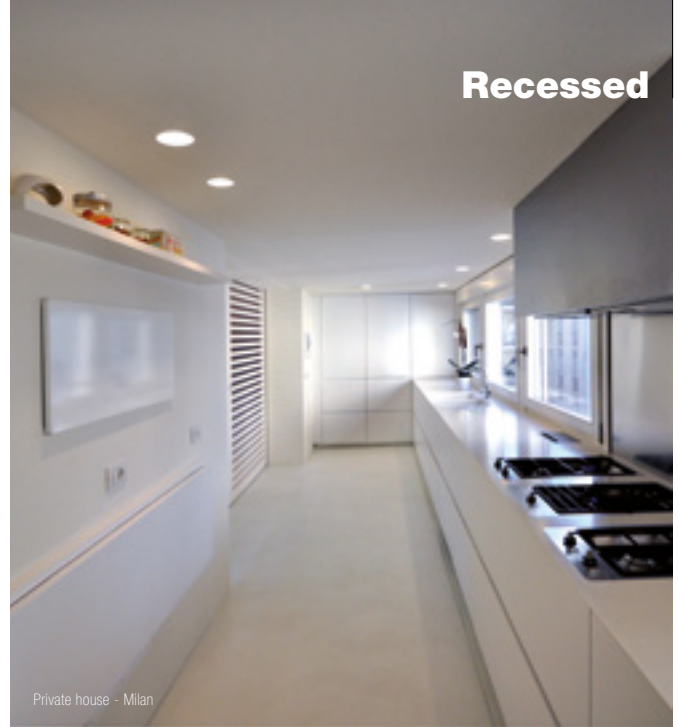
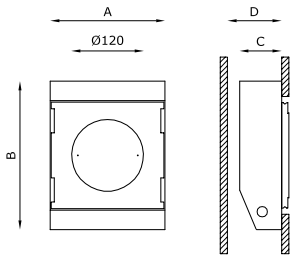

Technology combines with elegance to give life to a product with a clean and minimal design: the AirCoral® body of this luminaire, a totally disappearing, indoor, recessed, installable on plasterboard or brick walls and ceilings, is completely invisible. The satin glass, fixed with white polycarbonate screws perfectly positioned at the level of the body, creates a pure cone of light with a neat volume which embraces the surfaces below, breaking into darkness.





Private house - Milan

TECHNICAL FEATURES

Code	6191.AC	6192.AC	6193.Z.AC	6199.Z.AC
Type	Downlight 45° Wall recessed 45° 	Downlight 90° Wall recessed 90° 	Downlight 90° Wall recessed 90° 	Downlight 90° Wall recessed 90° 
Material	AC: AirCoral®	AC: AirCoral®	AC: AirCoral®	AC: AirCoral®
Absorption capacity*	1.88 m ²	1.88 m ²	1.88 m ²	1.88 m ²
Weight	1.5 Kg	1.5 Kg	1.5 Kg	2.5 Kg
Mounting	Wall and ceiling recessed	Wall and ceiling recessed	Wall and ceiling recessed	Wall and ceiling recessed
IP rating	IP40	IP40	IP40	IP40
Insulation class	III	III	III	III
Control gear	Dimmable electronic transformer	Dimmable electronic transformer	Constant current electronic driver	Constant current electronic driver
Dimensions	A: 190mm; B: 245mm; C: 70mm; D: 80mm	A: 190mm; B: 245mm; C: 70mm; D: 80mm	A: 190mm; B: 245mm; C: 70mm; D: 80mm	A: 190mm; B: 350mm; C: 70mm; D: 80mm
Cut out for plasterboard	195 x 185 mm	195 x 185 mm	195 x 185 mm	195 x 250 mm
Lamp type	QR CB 51 	QR CB 51 	LED 500 mA 	LED 500 mA 
Lamp wattage	1 x 50W max	1 x 50W max	1 x 9W	1 x 9W
Luminous efficacy	-	-	1125 lm - 3000K	1125 lm - 3000K
Light distribution	-	-	Wide beam 40°	Wide beam 40°
Fitting	GU5.3	GU5.3	-	-
Light colour	-	-	White 3000K White 2700K 4000K (on request)	White 3000K White 2700K 4000K (on request)
Light hole	Ø 120 mm	Ø 120 mm	Ø 120 mm	Ø 120 mm
Voltage connection	220-240V / 12V · 50/60Hz	220-240V / 12V · 50/60Hz	220-240V · 50/60Hz	220-240V · 50/60Hz
CRI	-	-	>90	>90
Emergency	-	-	-	1 hour
Energy efficiency class	A	A	A++	A++
Note	Extra white satin glass fixed by screws on wall/ceiling level.	Extra white satin glass fixed by screws on wall/ceiling level.	Extra white satin glass fixed by screws on wall/ceiling level. On request available dimmable PUSH or DALI.	Extra white satin glass fixed by screws on wall/ceiling level.

OPTIONAL ACCESSORIES

product code	optional code	description	info
6191.AC / 6192.AC	0008KIT	Kit LED dimmable	Bulb 7W - 12V

* The absorption capacity per m² calculated by the American organization TCNA (Tile Council of North America) is measured for an average room of 2.7 m in height and therefore expressed in m²



MINI SECRET



INCASSO A SOFFITTO CON VETRO A FILO.

Un piccolo scrigno che racchiude un segreto luminoso: Mini Secret 10x10, apparecchio da interni a scomparsa totale in AirCoral® per installazione in soffitto di cartongesso o laterizio, custodisce una luce in grado di impreziosire ambienti e arredi. Mini Secret 10x10 crea geometrie con rigore all'interno dell'ambiente, un punto di riferimento essenziale che, con semplicità ed eleganza, genera una luce in grado di valorizzare particolari e dettagli di ogni spazio.

CEILING RECESSED FITTING WITH FLUSH GLASS.



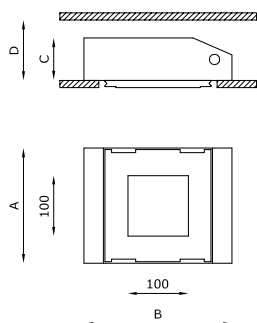





A small treasure chest that guards a bright secret: Mini Secret 10x10, a totally disappearing indoor recessed luminaire made of AirCoral®, installable on plasterboard or brick ceilings, enshrines a light able to enhance furniture and architectures. With precision and linearity, Mini Secret 10x10 creates geometries inside spaces, an essential reference point generating a light that enhances particulars and details inside any environment, with simplicity and elegance.



Recessed

Private house - ph. F. Gambina - Milan

TECHNICAL FEATURES

Code	6141.AC	6142.AC	6143.Z.AC	6149.Z.AC
Type	Downlight 45° 	Downlight 90° 	Downlight 90° 	Downlight 90° 
Material	AC: AirCoral®	AC: AirCoral®	AC: AirCoral®	AC: AirCoral®
Absorption capacity*	2.3 m ²	2.3 m ²	2.3 m ²	2.3 m ²
Weight	1.5 Kg	1.5 Kg	1.5 Kg	2.5 Kg
Mounting	Ceiling recessed	Ceiling recessed	Ceiling recessed	Ceiling recessed
IP rating	IP40	IP40	IP40	IP40
Insulation class	III	III	III	III
Control gear	Dimmable electronic transformer	Dimmable electronic transformer	Constant current electronic driver	Constant current electronic driver
Dimensions	A: 190mm; B: 245mm; C: 70mm; D: 80mm	A: 190mm; B: 245mm; C: 70mm; D: 80mm	A: 190mm; B: 245mm; C: 70mm; D: 80mm	A: 190mm; B: 350mm; C: 70mm; D: 80mm
Cut out for plasterboard	195 x 185 mm	195 x 185 mm	195 x 185 mm	195 x 250 mm
Lamp type	QR CB 51 	QR CB 51 	LED 500 mA 	LED 500 mA 
Lamp wattage	1 x 50W max	1 x 50W max	1 x 9W	1 x 9W
Luminous efficacy	-	-	1125 lm - 3000K	1125 lm - 3000K
Light distribution	-	-	Wide beam 40°	Wide beam 40°
Fitting	GU5.3	GU5.3	-	-
Light colour	-	-	White 3000K White 2700K 4000K (on request)	White 3000K White 2700K 4000K (on request)
Light hole	100 x 100 mm	100 x 100 mm	100 x 100 mm	100 x 100 mm
Voltage connection	220-240V / 12V · 50/60Hz	220-240V / 12V · 50/60Hz	220-240V · 50/60Hz	220-240V · 50/60Hz
CRI	-	-	>90	>90
Emergency	-	-	-	1 hour
Energy efficiency class	A	A	A++	A++
Note	Extra white satin glass leaned on ceiling level.	Extra white satin glass leaned on ceiling level.	Extra white satin glass leaned on ceiling level. On request available dimmable PUSH or DALI.	Extra white satin glass leaned on ceiling level.

OPTIONAL ACCESSORIES

product code	optional code	description	info
6141.AC / 6142.AC	0008KIT	Kit LED dimmable	Bulb 7W - 12V

* The absorption capacity per m² calculated by the American organization TCNA (Tile Council of North America) is measured for an average room of 2.7 m in height and therefore expressed in m²



Private villa - A. Ogarrió J. Zapata Arquitectos SC - Mexico



Design
Matteo Baroni



ATOM



UN SEMI INCASSO DALLE FORME SINUOSE.

La forma si coniuga con la sostanza, il design diventa l'essenza dell'eleganza, in un apparecchio dalle linee morbide e sinuose: Atom, semincasso a scomparsa totale per installazione in soffitto di cartongesso o laterizio, è una soluzione dal fascino unico. Il vetro si adagia sulle linee sinuose del corpo in AirCoral® e grazie alla finitura satinata consente al fascio di luce di diffondersi in modo omogeneo nello spazio.

Un apparecchio che fa della semplicità la sua forza, una risposta innovativa al desiderio di illuminare con stile qualsiasi ambiente.

A SEMI-RECESSED FITTING WITH SINUOUS SHAPES.

Form combines with substance and design becomes the essence of elegance in a product with soft and sinuous lines: Atom, an indoor totally disappearing semi recessed luminaire, installable on plasterboard or brick ceilings, is a solution with a unique appeal. The glass covers up the elegant lines of the AirCoral® body thanks to satin finishing touches, which allow the beams of light to uniformly scatter within the space. A luminaire with a strong yet delicate effect, an innovative answer to the desire of lighting every environment with style.

Recessed

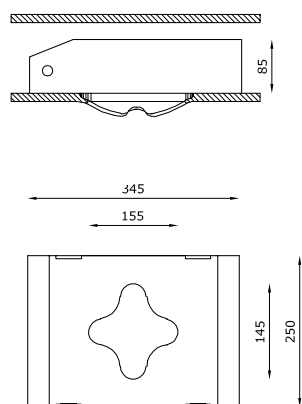

Private House - Arch. L. Picardi - Naples

TECHNICAL FEATURES

Code	6153.Z.AC	6152.AC
Type	Downlight 90° 	Downlight 90° 
Material	AC: AirCoral®	AC: AirCoral®
Absorption capacity*	4.28 m²	4.28 m²
Weight	2.5 Kg	1.5 Kg
Mounting	Ceiling half recessed	Ceiling half recessed
IP rating	IP40	IP40
Insulation class	III	III
Control gear	Constant current electronic driver	Dimmable electronic transformer
Cut out for plasterboard	250 x 280 mm	250 x 280 mm
Lamp type	LED 500mA 	QR CB 51 
Lamp wattage	1 x 9W	1 x 50W max
Luminous efficacy	1125 lm - 3000K	-
Light distribution	Wide beam 40°	-
Fitting	-	GU5.3
Light colour	White 3000K White 2700K 4000K (on request)	-
Light hole	145 x 155 mm	145 x 155 mm
Voltage connection	220-240V · 50/60Hz	220-240V / 12V · 50/60Hz
CRI	>90	-
Emergency	-	-
Energy efficiency class	A++	A
Note	Extra white satin glass. On request available dimmable PUSH or DALI.	Extra white satin glass.

OPTIONAL ACCESSORIES

product code	optional code	description	info
6152.AC	0008KIT	Kit LED dimmable	Bulb 7W · 12V

* The absorption capacity per m³ calculated by the American organization TCNA (Tile Council of North America) is measured for an average room of 2.7 m in height and therefore expressed in m²



INVISILED



MINIME DIMENSIONI: 40 x 40 mm.

La luce scaturisce improvvisamente da un punto nella parete, pura e delicata si diffonde in modo omogeneo nello spazio, avvolgendo, indisturbata, tutto l'ambiente. Invisiled, incasso a scomparsa totale in AirCoral® per installazione in parete e soffitto di cartongesso o laterizio, è pensato per progetti in cui la luce deve essere protagonista. Invisiled si adatta ad ogni ambiente, regalando concretezza agli spunti del progettista, inserendosi con discrezione negli spazi.

MINIMUM DIMENSIONS: 40 x 40 mm.

Pure and delicate light suddenly springs from a spot on the wall, and it spreads out homogeneously in the space, enfolding the whole room, undisturbed. Invisiled, a totally disappearing recessed luminaire made of AirCoral®, installable on plasterboard or brick walls and ceilings, is studied for projects where light has the main role. Invisiled fits into any environment, giving concreteness to the designer's inspirations, and discreetly integrating itself into spaces.

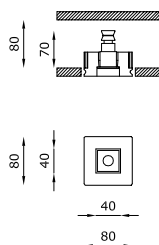

TECHNICAL FEATURES

Code	6348.AC
Type	Downlight 90° Wall recessed 90°
Material	AC: AirCoral®
Absorption capacity*	1.05 m ²
Weight	0.3 Kg
Mounting	Wall and ceiling recessed
IP rating	IP40
Insulation class	III
Control gear	Constant current electronic driver (not included)
Cut out for plasterboard	90 x 90 mm
Lamp type	LED Vf: 3 VDC
Lamp wattage	1W - 350 mA 2W - 500 mA
Luminous efficacy	75 lm - 3000K 350 mA 170 lm - 3000K 500 mA
Light distribution	Narrow beam 14°
Fitting	-
Light colour	White 3000K White 2700K (on request)
Light hole	40 x 40 mm
Voltage connection	By driver (optional)
CRI	>90
Emergency	-
Energy efficiency class	A++
Note	On request available dimmable PUSH or DALI, remote installation. This product could be ordered with IP44 / IP65 protection grade (see OUTDOOR section - code 6349.CW / 6347.CW).

OPTIONAL ACCESSORIES

<i>product code</i>	<i>optional code</i>	<i>description</i>	<i>info</i>
6348.AC	H8350	Constant current electronic driver	Suitable for n°1 code 6348.AC - 350 mA
	H8500.B	Constant current electronic driver. Remote installation	Suitable for n°5 code 6348.AC - 500 mA
	H8500.C	Constant current electronic driver. Remote installation	Suitable for n°2 code 6348.AC - 500 mA

* The absorption capacity per m² calculated by the American organization TCNA (Tile Council of North America) is measured for an average room of 2.7 m in height and therefore expressed in m²





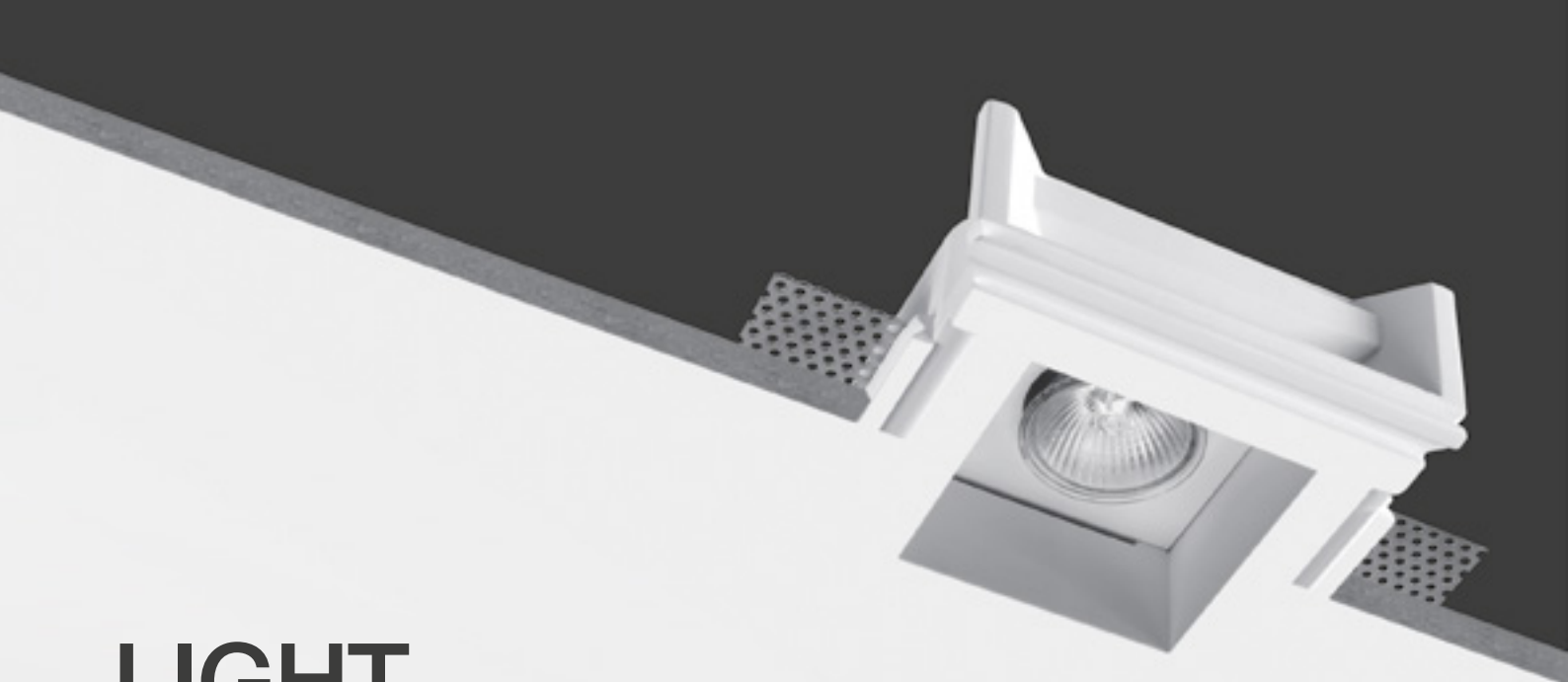

LIGHT



SINGOLA E DOPPIA LUCE CON LED A VISTA.

Light è sostanza che si fonde con la materia per dare vita a una tecnologia che garantisca sempre il miglior risultato possibile, è pura luce. Apparecchio da interni a scomparsa totale in AirCoral® per installazione in soffitto di cartongesso o laterizio, Light si fonde con lo spazio in cui viene inserito. Disponibile in versione singola (Monolight) o doppia (Bilight), la sorgente luminosa retrocessa con meccanica a vista genera una luce precisa e tecnica, in grado di cambiare l'equilibrio di un ambiente.

SINGLE AND DOUBLE LIGHT WITH EXPOSED LED.

Light is substance blending in with matter to give life to a technology that guarantees the best result ever, is pure light. A totally disappearing indoor recessed luminaire made of AirCoral®, installable on plasterboard or brick ceilings, Light blends into the space it is inserted in. Available in single (Monolight) or double version (Bilight), its recessed light source with in-view mechanics creates a precise, technical light, able to change the balance of an environment.

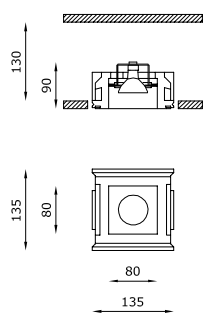



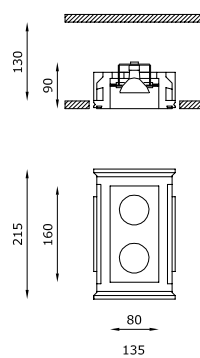





A. MONOLIGHT



B. BILIGHT

TECHNICAL FEATURES

Code	6323.AC (fig. A)	6328.Z.AC (fig. A)	6313.AC (fig. B)	6318.Z.AC (fig. B)
Type	Downlight 90° 	Downlight 90° 	Downlight 90° 	Downlight 90° 
Material	AC: AirCoral®	AC: AirCoral®	AC: AirCoral®	AC: AirCoral®
Absorption capacity*	2.82 m ²	2.82 m ²	4.68 m ²	4.68 m ²
Weight	0.9 Kg	0.9 Kg	1.3 Kg	1.3 Kg
Mounting	Ceiling recessed	Ceiling recessed	Ceiling recessed	Ceiling recessed
IP rating	IP20	IP20	IP20	IP20
Insulation class	III	III	III	III
Control gear	Electronic transformer (not included)	Constant current electronic driver (not included)	Electronic transformer (not included)	Constant current electronic driver (not included)
Cut out for plasterboard	145 x 145 mm	145 x 145 mm	225 x 145 mm	225 x 145 mm
Lamp type	QR CB 51 	LED 500 mA  Vf: 18 VDC	QR CB 51 	LED 500 mA  Vf: 2 x 18 VDC
Lamp wattage	1 x 50W max	1 x 9W	2 x 50W max	2 x 9W
Luminous efficacy	-	1125 lm - 3000K	-	2 x 1125 lm - 3000K
Light distribution	-	Wide beam 40°	-	Wide beam 40°
Fitting	GU5.3	-	GU5.3	-
Light colour	-	White 3000K White 2700K 4000K (on request)	-	White 3000K White 2700K 4000K (on request)
Light hole	80 x 80 mm	80 x 80 mm	160 x 80 mm	160 x 80 mm
Voltage connection	By driver (optional)	By driver (optional)	By driver (optional)	By driver (optional)
CRI	-	>90	-	>90
Emergency	-	-	-	-
Energy efficiency class	A	A++	A	A++
Note	-	On request available dimmable PUSH or DALI. On request available emergency.	-	On request available dimmable PUSH or DALI. On request available emergency.

OPTIONAL ACCESSORIES

product code	optional code	description	info
6323.AC	H8060.LED	Dimmable electronic transformer	Max watt 60W Volts · Hz 230/12V · 50/60Hz
	0008KIT	Kit LED dimmable	Bulb 7W · 12V
	BR6323LT	Brick box	Dimensions L: 195 mm; W: 160 mm; D: 160 mm (instructions on page 502)
6328.Z.AC	H8500.E	Constant current electronic driver	Suitable for n°2 code 6328.Z.AC - 500 mA
	H8500.B	Constant current electronic driver	Suitable for n°1 code 6328.Z.AC - 500 mA
	BR6328LT	Brick box	Dimensions L: 195 mm; W: 160 mm; D: 160 mm (instructions on page 502)
6313.AC	H8105	Dimmable electronic transformer	Max watt 105W Volts · Hz 230/12V · 50/60Hz
	0008KIT	Kit LED dimmable	Bulb 7W · 12V
	BR6313LT	Brick box	Dimensions L: 230 mm; W: 150 mm; D: 160 mm (instructions on page 502)
6318.Z.AC	H8500.E	Constant current electronic driver	Suitable for n°1 code 6318.Z.AC - 500 mA
	BR6318LT	Brick box	Dimensions L: 230 mm; W: 150 mm; D: 160 mm (instructions on page 502)

* The absorption capacity per m² calculated by the American organization TCNA (Tile Council of North America) is measured for an average room of 2.7 m in height and therefore expressed in m²



JACOBBOX



INCASSO DIREZIONABILE.

Jacobox è un apparecchio da interni a scomparsa totale per installazione in parete e soffitto di cartongesso o laterizio realizzato in AirCoral®.







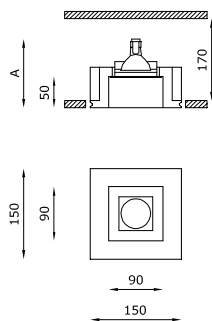

La sorgente luminosa retrocessa con meccanica a vista orientabile dona una luce precisa e puntuale, senza sacrificare l'eleganza degli spazi.

ADJUSTABLE RECESSED FITTING.

Jacobox is a totally disappearing indoor recessed luminaire, installable on plasterboard or brick walls and ceilings made of AirCoral®. With its visible and adjustable mechanic structure, the recessed luminescent source emanates a precise and punctual light without renouncing space elegance.



TECHNICAL FEATURES

Code	6248.Z.AC	6249.Z.AC	6241.AC	6244.AC
Type	Tilttable downlight and wall recessed $\pm 30^\circ$ 	Tilttable downlight and wall recessed $\pm 30^\circ$ 	Tilttable downlight and wall recessed $\pm 30^\circ$ 	Tilttable downlight and wall recessed $\pm 30^\circ$ 
Material	AC: AirCoral®	AC: AirCoral®	AC: AirCoral®	AC: AirCoral®
Absorption capacity*	3.07 m ²	3.07 m ²	3.07 m ²	3.07 m ²
Weight	1.3 Kg	1.8 Kg	1.1 Kg	1.1 Kg
Mounting	Wall and ceiling recessed	Wall and ceiling recessed	Wall and ceiling recessed	Wall and ceiling recessed
IP rating	IP20	IP20	IP20	IP20
Insulation class	III	III	III	I
Control gear	Constant current electronic driver (not included)	Constant current electronic driver	Electronic transformer (not included)	-
Dimensions	A: 130 mm	A: 130 mm	A: 130 mm	A: 130 mm
Cut out for plasterboard	160 x 160 mm	160 x 160 mm	160 x 160 mm	160 x 160 mm
Lamp type	LED 500 mA  Vf: 18 VDC	LED 500 mA 	QR CB 51 	QPAR 16 
Lamp wattage	1 x 9W	1 x 9W	1 x 50W max	1 x 50W max
Luminous efficacy	1125 lm - 3000K	1125 lm - 3000K	-	-
Light distribution	Wide beam 40°	Wide beam 40°	-	-
Fitting	-	-	GU5.3	GU10
Light colour	White 3000K White 2700K 4000K (on request)	White 3000K White 2700K 4000K (on request)	-	-
Light hole	90 x 90 mm	90 x 90 mm	90 x 90 mm	90 x 90 mm
Voltage connection	By driver (optional)	220-240V · 50/60Hz	By driver (optional)	220-240V · 50/60Hz
CRI	>90	>90	-	-
Emergency	-	1 hour	-	-
Energy efficiency class	A++	A++	A	A
Note	On request available dimmable PUSH or DALI.	-	-	-

OPTIONAL ACCESSORIES

product code	optional code	description	info
6248.Z.AC	H8500.E	Constant current electronic driver	Suitable for n°2 code 6248.Z.AC - 500 mA
	H8500.B	Constant current electronic driver	Suitable for n°1 code 6248.Z.AC - 500 mA
	BR6248LT	Brick box	Dimensions L: 195 mm; W: 160 mm; D: 160 mm (instructions on page 502)
6241.AC	H8060.LED	Dimmable electronic transformer	Max watt 60W Volts · Hz 230/12V · 50/60Hz
	0008KIT	Kit LED dimmable	Bulb 7W · 12V
	BR6241LT	Brick box	Dimensions L: 195 mm; W: 160 mm; D: 160 mm (instructions on page 502)
6244.AC	0009KIT	Kit LED dimmable	Bulb 6W · 220-240V
	BR6244LT	Brick box	Dimensions L: 195 mm; W: 160 mm; D: 160 mm (instructions on page 502)

* The absorption capacity per m² calculated by the American organization TCNA (Tile Council of North America) is measured for an average room of 2.7 m in height and therefore expressed in m²



Private house - ASZ Architeti



Private villa - Forti





BITRIX



INCASSO DOPPIO ED ORIENTABILE.

Apparecchio da interni a scomparsa totale in AirCoral® per installazione in soffitto di cartongesso. Bitrix è dotato di meccanica a vista orientabile, con una sorgente retrocessa di 50 mm. Il fascio di luce emanato è orientabile di 30°, riuscendo a completare e valorizzare il progetto illuminotecnico in ogni suo dettaglio.

DOUBLE AND ADJUSTABLE RECESSED FITTING.

A total recessed indoor luminaire of AirCoral® installable on plasterboards ceilings, Bitrix is provided with visible and orientable mechanisms. It also has a tiltable recessed light source of 50 mm and its beam, adjustable up to 30°, completes and valorizes every single detail of the lighting project.

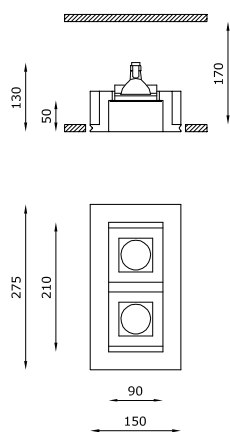

TECHNICAL FEATURES

Code	6343.Z.AC	6342.AC
Type	Tilttable downlight ± 30° 	Tilttable downlight ± 30° 
Material	AC: AirCoral®	AC: AirCoral®
Absorption capacity*	5.83 m ²	5.83 m ²
Weight	2 Kg	2 Kg
Mounting	Ceiling recessed	Ceiling recessed
IP rating	IP20	IP20
Insulation class	III	III
Control gear	Constant current electronic driver (not included)	Electronic transformer (not included)
Cut out for plasterboard	285 x 160 mm	285 x 160 mm
Lamp type	LED 500 mA  Vf: 2 x 18 VDC	QR CB 51 
Lamp wattage	2 x 9W	2 x 50W max
Luminous efficacy	2 x 1125 lm - 3000K	-
Light distribution	Wide beam 40°	-
Fitting	-	GU5.3
Light colour	White 3000K White 2700K 4000K (on request)	-
Light hole	210 x 90 mm	210 x 90 mm
Voltage connection	By driver (optional)	By driver (optional)
CRI	>90	-
Emergency	-	-
Energy efficiency class	A++	A
Note	On request available dimmable PUSH or DALI. On request available emergency.	-

OPTIONAL ACCESSORIES

product code	optional code	description	info
6343.Z.AC	H8500.E	Constant current electronic driver	Suitable for n°1 code 6343.Z.AC - 500 mA
6342.AC	H8150 0008KIT	Dimmable electronic transformer Kit LED dimmable	Max watt 150W Volts · Hz 230/12V · 50/60Hz Bulb 7W · 12V

* The absorption capacity per m² calculated by the American organization TCNA (Tile Council of North America) is measured for an average room of 2.7 m in height and therefore expressed in m²

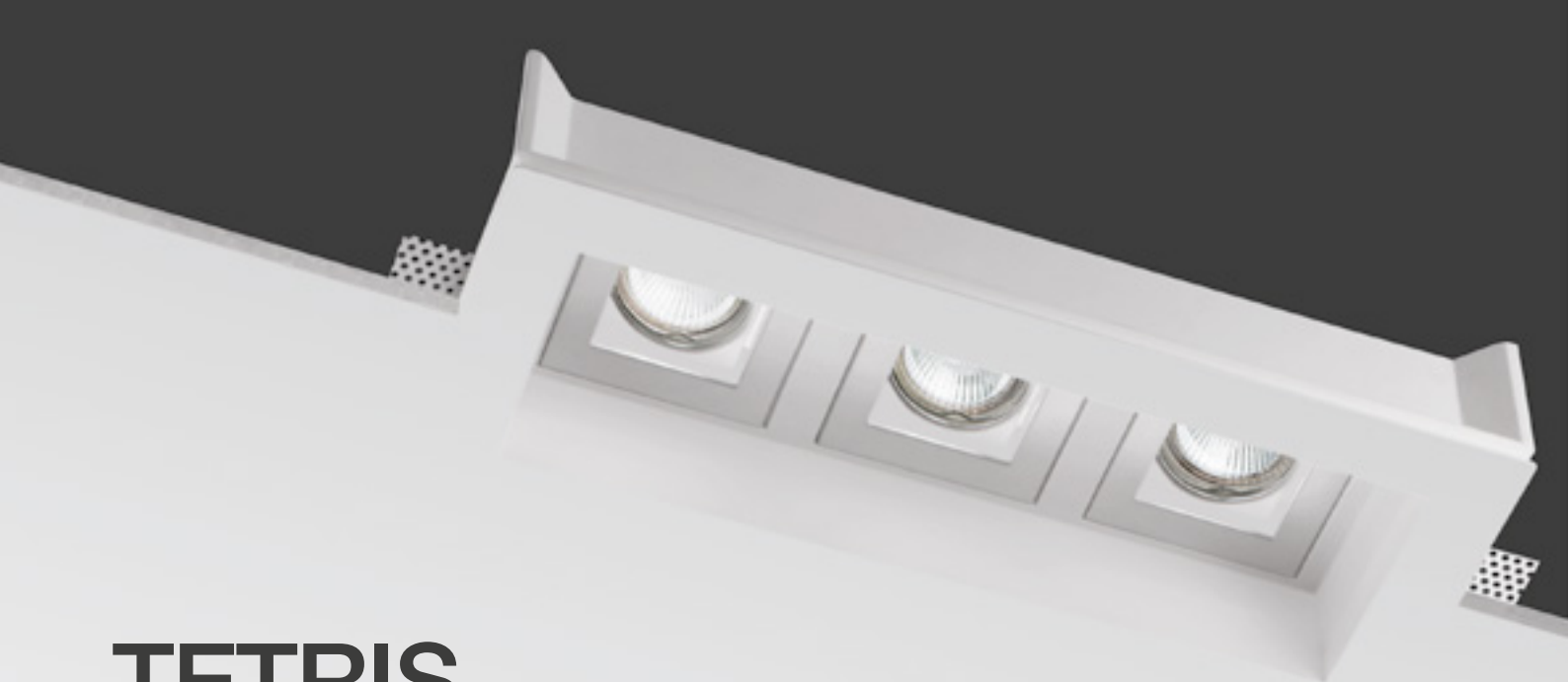

TETRIS



INCASSO TRIPLO ED ORIENTABILE.

Giocare con la luce non è mai stato così semplice come con Tetris, un incasso a scomparsa totale da interni in AirCoral® per installazione in soffitto di cartongesso dotato di meccanica a vista orientabile. La luce, emanata da tre sorgenti retrocesse di 50 mm, si incastra perfettamente all'interno del progetto architettonico in modo sempre preciso e deciso sull'oggetto da illuminare.

TRIPLE AND ADJUSTABLE RECESSED FITTING.

Playing with light has never been as easy as with Tetris, a totally disappearing luminaire made of AirCoral®, installable on plasterboard ceilings and provided with a visible and adjustable mechanic structure. Coming from three different recessed sources of 50mm each, the light perfectly suits the architectonic project, illuminating spaces and objects in a constantly precise and effective way.

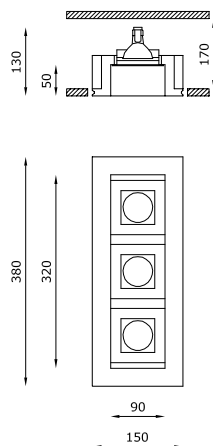

TECHNICAL FEATURES

Code	6246.Z.AC	6242.AC
Type	Tilttable downlight ± 30° 	Tilttable downlight ± 30° 
Material	AC: AirCoral®	AC: AirCoral®
Absorption capacity*	8.29 m ²	8.29 m ²
Weight	2.7 Kg	2.7 Kg
Mounting	Ceiling recessed	Ceiling recessed
IP rating	IP20	IP20
Insulation class	III	III
Control gear	Constant current electronic driver (not included)	Electronic transformer (not included)
Cut out for plasterboard	390 x 160 mm	390 x 160 mm
Lamp type	LED 500 mA ⚡ V _f : 3 x 18 VDC	QR CB 51 
Lamp wattage	3 x 9W	3 x 50W max
Luminous efficacy	3 x 1125 lm - 3000K	-
Light distribution	Wide beam 40°	-
Fitting	-	GU5.3
Light colour	White 3000K White 2700K 4000K (on request)	-
Light hole	320 x 90 mm	320 x 90 mm
Voltage connection	By driver (optional)	By driver (optional)
CRI	>90	-
Emergency	-	-
Energy efficiency class	A++	A
Note	On request available dimmable PUSH or DALI. On request available emergency.	-

OPTIONAL ACCESSORIES

product code	optional code	description	info
6246.Z.AC	H8500.E	Constant current electronic driver	Required 2 remote drivers code H8500.E for each code 6246.Z.AC - 500 mA
6242.AC	H8150 0008KIT	Dimmable electronic transformer Kit LED dimmable	Max watt 150W Volts · Hz 230/12V · 50/60Hz Bulb 7W · 12V

* The absorption capacity per m² calculated by the American organization TCNA (Tile Council of North America) is measured for an average room of 2.7 m in height and therefore expressed in m²

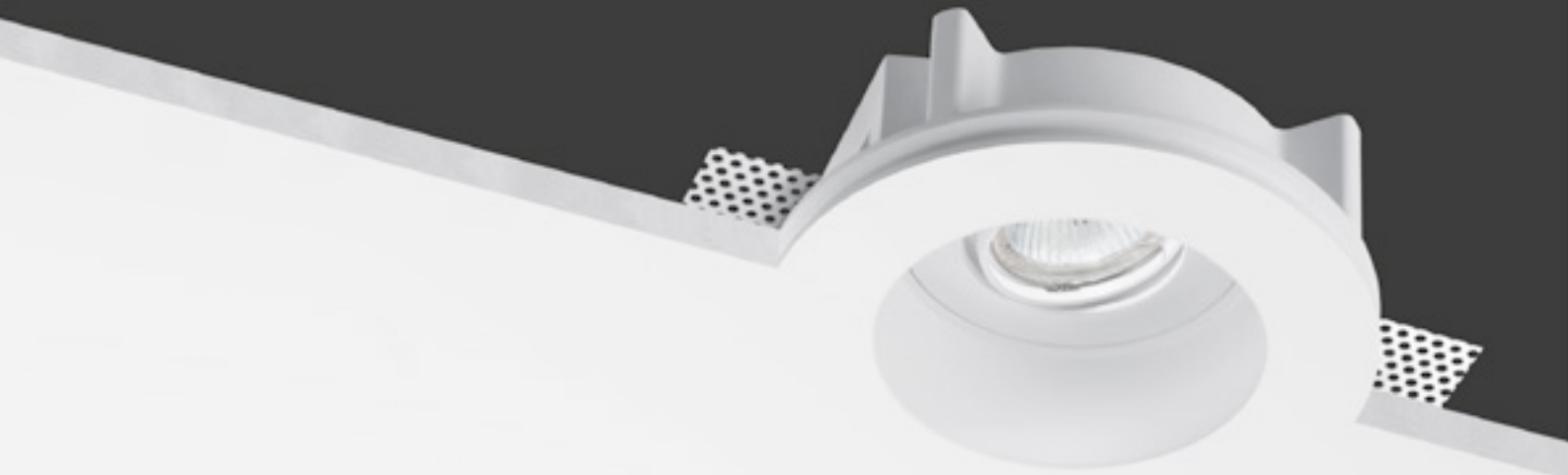

RING



INCASSO ORIENTABILE.

Armonia e luce, design e semplicità, eleganza e discrezione: Ring è un incasso a scomparsa totale da interni con corpo in AirCoral® per installazione a soffitto e a parete di cartongesso o laterizio che impreziosisce gli ambienti in cui viene installato. Una luce essenziale che dialoga con un prodotto altamente tecnico. La meccanica orientabile e la sorgente retrocessa di 40 mm rendono Ring estremamente versatile e lo mantengono in equilibrio tra funzionalità e design.

ADJUSTABLE RECESSED FITTING.

Harmony and light, design and simplicity, elegance and discretion: Ring is the indoor totally disappearing recessed luminaire made of AirCoral®, installable on plasterboard or brick ceilings, that decorates the spaces it is installed in. A simple shaped light combined with a highly technical product. The directable mechanic and the 40 mm reverse light source make Ring extremely versatile and balanced between functionality and design.

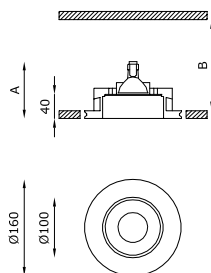

TECHNICAL FEATURES

Code	6238.Z.AC	6239.Z.AC	6243.AC	6253.AC
Type	Tilttable downlight and wall recessed $\pm 30^\circ$ 	Tilttable downlight and wall recessed $\pm 30^\circ$ 	Tilttable downlight and wall recessed $\pm 30^\circ$ 	Tilttable downlight and wall recessed $\pm 30^\circ$
Material	AC: AirCoral®	AC: AirCoral®	AC: AirCoral®	AC: AirCoral®
Absorption capacity*	2.52 m ²	2.52 m ²	2.52 m ²	2.52 m ²
Weight	0.9 Kg	1.4 Kg	0.8 Kg	0.8 Kg
Mounting	Wall and ceiling recessed	Wall and ceiling recessed	Wall and ceiling recessed	Wall and ceiling recessed
IP rating	IP20	IP20	IP20	IP20
Insulation class	III	III	III	I
Control gear	Constant current electronic driver (not included)	Constant current electronic driver	Electronic transformer (not included)	-
Dimensions	A: 90 mm; B: 120 mm	A: 90 mm; B: 150 mm	A: 100 mm; B: 150 mm	A: 100 mm; B: 150 mm
Cut out for plasterboard	Ø 170 mm	Ø 170 mm	Ø 170 mm	Ø 170 mm
Lamp type	LED 500 mA Vf: 18 VDC	LED 500 mA 	QR CB 51 	QPAR 16
Lamp wattage	1 x 9W	1 x 9W	1 x 50W max	1 x 50W max
Luminous efficacy	1125 lm - 3000K	1125 lm - 3000K	-	-
Light distribution	Wide beam 40°	Wide beam 40°	-	-
Fitting	-	-	GU5.3	GU10
Light colour	White 3000K White 2700K 4000K (on request)	White 3000K White 2700K 4000K (on request)	-	-
Light hole	Ø 100 mm	Ø 100 mm	Ø 100 mm	Ø 100 mm
Voltage connection	By driver (optional)	220-240V · 50/60Hz	By driver (optional)	220-240V · 50/60Hz
CRI	>90	>90	-	-
Emergency	-	1 hour	-	-
Energy efficiency class	A++	A++	A	A
Note	On request available dimmable PUSH or DALI.	-	-	-

OPTIONAL ACCESSORIES

product code	optional code	description	info
6238.Z.AC	H8500.E	Constant current electronic driver	Suitable for n°2 code 6238.Z.AC - 500 mA
	H8500.B	Constant current electronic driver	Suitable for n°1 code 6238.Z.AC - 500 mA
	BR6238LT	Brick box	Dimensions L: 195 mm; W: 160 mm; D: 160 mm (instructions on page 502)
6243.AC	H8060.LED	Dimmable electronic transformer	Max watt 60W Volts · Hz 230/12V · 50/60Hz
	0008KIT	Kit LED dimmable	Bulb 7W · 12V
	BR6243LT	Brick box	Dimensions L: 195 mm; W: 160 mm; D: 160 mm (instructions on page 502)
6253.AC	0009KIT	Kit LED dimmable	Bulb 6W · 220-240V
	BR6253LT	Brick box	Dimensions L: 195 mm; W: 160 mm; D: 160 mm (instructions on page 502)

* The absorption capacity per m² calculated by the American organization TCNA (Tile Council of North America) is measured for an average room of 2.7 m in height and therefore expressed in m²



SUPERFUTUREDESIGN* - ph. Alessandro Moggi





BASIC ROUND



ECONOMICO, SEMPLICE E MINIMO INGOMBRO.

Le linee pure e semplici della forma geometrica per eccellenza — il cerchio — la cui armonia si incontra con la luce con l'obiettivo di impreziosire ambienti e situazioni: Basic Round è un incasso a scomparsa totale in Coral® per installazione a soffitto di cartongesso o laterizio dal design unico e minimale, perfetto per illuminare gli spazi in modo discreto ed elegante.

Un apparecchio da interni adatto ad accogliere unicamente sorgenti luminose LED, retrocesse di 20 mm rispetto al filo del soffitto, che soddisfa qualsiasi esigenza progettuale ed esalta con naturalezza le superfici in cui l'apparecchio viene installato.

CHEAP, SIMPLE AND MINIMUM DIMENSIONS.

The pure and simple lines of the geometrical shape par excellence — the circle — whose harmony come together with light to enhance spaces and situations: Basic Round is a totally disappearing recessed luminaire made of Coral®, installable on plasterboard or brick ceilings with a unique and minimal design, perfect for illuminating spaces in a discreet and elegant way. Designed for the indoor, it can be only provided with LED luminescent sources positioned 20 mm backwards from the ceiling level. Basic Round suits any architectonic projects, spontaneously emphasizing the surfaces it is installed on.

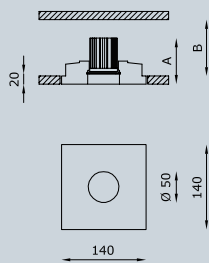

TECHNICAL FEATURES

Code	3121.00	3122.00	3123.Z.00
Type	Downlight 90°	Downlight 90°	Downlight 90°
Material	00: Coral®	00: Coral®	00: Coral®
Weight	0.7 Kg	0.7 Kg	0.8 Kg
Mounting	Ceiling recessed	Ceiling recessed	Ceiling recessed
IP rating	IP20	IP20	IP20
Insulation class	III	I	III
Control gear	Electronic transformer (not included)	-	Constant current electronic driver (not included)
Dimensions	A: 70 mm; B: 90 mm	A: 80 mm; B: 100 mm	A: 80 mm; B: 100 mm
Cut out for plasterboard	150 x 150 mm	150 x 150 mm	150 x 150 mm
Lamp type	QR CB 51 LED (optional)	QPAR 16 LED (optional)	LED 500 mA Vf: 18 VDC
Lamp wattage	-	-	1 x 9W
Luminous efficacy	-	-	1125 lm - 3000K
Light distribution	-	-	Wide beam 40°
Fitting	GU5.3	GU10	-
Light colour	-	-	White 3000K White 2700K 4000K (on request)
Light hole	Ø 50 mm	Ø 50 mm	Ø 50 mm
Voltage connection	By driver (optional)	220-240V · 50/60Hz	By driver (optional)
CRI	-	-	>90
Emergency	-	-	-
Energy efficiency class	A	A	A++
Note	-	-	On request available dimmable PUSH or DALI.

OPTIONAL ACCESSORIES

product code	optional code	description	info
3121.00	H8060.LED	Dimmable electronic transformer	Max watt 60W Volts · Hz 230/12V · 50/60Hz
	0008KIT	Kit LED dimmable	Bulb 7W · 12V
	BR3121LT	Brick box	Dimensions L: 195 mm; W: 150 mm; D: 160 mm (instructions on page 502)
3122.00	0009KIT	Kit LED dimmable	Bulb 6W · 220-240V
	BR3122LT	Brick box	Dimensions L: 195 mm; W: 150 mm; D: 160 mm (instructions on page 502)
3123.Z.00	H8500.E	Constant current electronic driver. Remote installation	Suitable for n°2 code 3123.Z.00 - 500 mA
	H8500.B	Constant current electronic driver	Suitable for n°1 code 3123.Z.00 - 500 mA
	BR3123LT	Brick box	Dimensions L: 195 mm; W: 150 mm; D: 160 mm (instructions on page 502)

Basic Round



SUPERFUTUREDESIGN™





BASIC SQUARE



MINIMO INGOMBRO ED ATTENZIONE AL BUDGET.





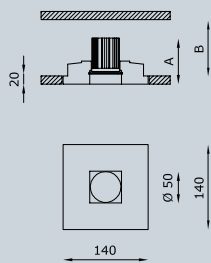

In Basic Square, incasso a scomparsa totale da interni in Coral® per installazione a soffitto di cartongesso o laterizio, le linee geometriche e il design minimale si compongono per creare una luce concreta, che mostra fin dal primo sguardo tutta la sua consistenza. Un apparecchio da interni adatto ad accogliere unicamente sorgenti luminose LED, retrocesse di 20 mm rispetto al filo del soffitto.

MINIMUM DIMENSIONS AND ATTENTION TO THE BUDGET.

In Basic Square, an indoor totally disappearing recessed luminaire made of Coral®, installable on plasterboard or brick ceilings, geometrical lines and minimal design come together to create a concrete light, that shows all its consistency since the first glance. Designed for the indoor, it can be only provided with LED luminescent sources positioned 20 mm backwards from the ceiling level.



TECHNICAL FEATURES

Code	3111.00	3112.00	3113.Z.00
Type	Downlight 90° 	Downlight 90° 	Downlight 90° 
Material	00: Coral®	00: Coral®	00: Coral®
Weight	0.7 Kg	0.7 Kg	0.8 Kg
Mounting	Ceiling recessed	Ceiling recessed	Ceiling recessed
IP rating	IP20	IP20	IP20
Insulation class	III	I	III
Control gear	Electronic transformer (not included)	-	Constant current electronic driver (not included)
Dimensions	A: 70 mm; B: 90 mm	A: 80 mm; B: 100 mm	A: 80 mm; B: 100 mm
Cut out for plasterboard	150 x 150 mm	150 x 150 mm	150 x 150 mm
Lamp type	QR CB 51 LED (optional) 	QPAR 16 LED (optional) 	LED 500 mA  Vf: 18 VDC
Lamp wattage	-	-	1 x 9W
Luminous efficacy	-	-	1125 lm - 3000K
Light distribution	-	-	Wide beam 40°
Fitting	GU5.3	GU10	-
Light colour	-	-	White 3000K White 2700K 4000K (on request)
Light hole	50 x 50 mm	50 x 50 mm	50 x 50 mm
Voltage connection	By driver (optional)	220-240V · 50/60Hz	By driver (optional)
CRI	-	-	>90
Emergency	-	-	-
Energy efficiency class	A	A	A++
Note	-	-	On request available dimmable PUSH or DALI.

OPTIONAL ACCESSORIES

product code	optional code	description	info
3111.00	H8060.LED	Dimmable electronic transformer	Max watt 60W Volts · Hz 230/12V · 50/60Hz
	0008KIT	Kit LED dimmable	Bulb 7W · 12V
	BR3111LT	Brick box	Dimensions L: 195 mm; W: 150 mm; D: 160 mm (instructions on page 502)
3112.00	0009KIT	Kit LED dimmable	Bulb 6W · 220-240V
	BR3112LT	Brick box	Dimensions L: 195 mm; W: 150 mm; D: 160 mm (instructions on page 502)
3113.Z.00	H8500.E	Constant current electronic driver. Remote installation	Suitable for n°2 code 3113.Z.00 - 500 mA
	H8500.B	Constant current electronic driver	Suitable for n°1 code 3113.Z.00 - 500 mA
	BR3113LT	Brick box	Dimensions L: 195 mm; W: 150 mm; D: 160 mm (instructions on page 502)

Basic Square



SUPERFUTUREDESIGN





BLACK BOX



INCASSO ORIENTABILE
A 1, 2 O 3 PUNTI LUCE.





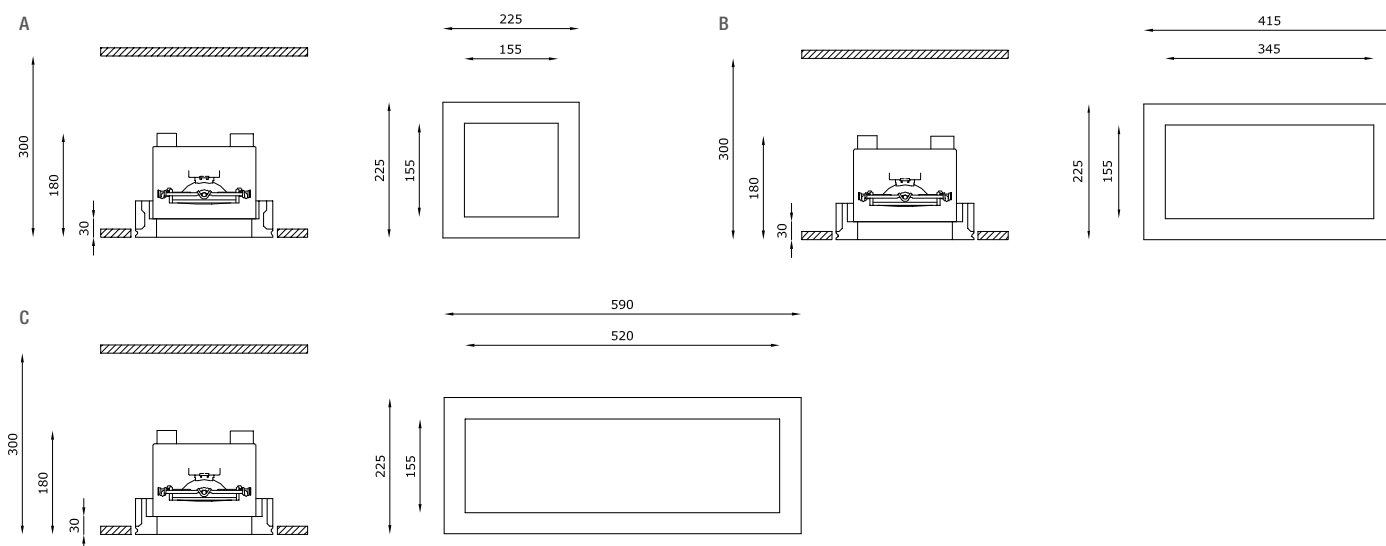

Una scatola nera da cui la luce emana tutta la sua potenza: Black Box, con corpo in AirCoral[®], è un apparecchio per interni a scomparsa totale per installazione in soffitto di cartongesso, in cui la posizione arretrata delle sorgenti luminose è studiata per avere il minimo impatto visivo. Disponibile in versione singola, doppia e tripla, Black Box è il prodotto ideale per valorizzare, attraverso la luce dettagli, oggetti e situazioni in modo deciso e preciso.

ADJUSTABLE RECESSED LIGHT
WITH 1, 2 OR 3 LIGHT POINTS.

A black box emanating light in all its power: Black Box, made of AirCoral[®], is a totally disappearing indoor recessed plasterboard ceiling flush mount, whose rearward light sources are studied to have a minimal visual impact. Available in single, double or triple version, Black Box is the ideal product to highlight details, objects and situations through light, in a moderate and precise way.



TECHNICAL FEATURES

Code	6061.AC (fig. A)	6071.AC (fig. B)	6081.AC (fig. C)
Type	Tilttable downlight $\pm 40^\circ$ 	Tilttable downlight $\pm 40^\circ$ 	Tilttable downlight $\pm 40^\circ$ 
Material	AC: AirCoral®	AC: AirCoral®	AC: AirCoral®
Absorption capacity*	4.55 m ²	6.75 m ²	8.95 m ²
Weight	3.2 Kg	4.2 Kg	4.6 Kg
Mounting	Ceiling recessed	Ceiling recessed	Ceiling recessed
IP rating	IP20	IP20	IP20
Insulation class	III	III	III
Control gear	Electronic transformer (not included)	Electronic transformer (not included)	Electronic transformer (not included)
Cut out for plasterboard	235 x 235 mm	235 x 425 mm	235 x 600 mm
Lamp type	QR 111 	QR 111 	QR 111 
Lamp wattage	1 x 100W max	2 x 100W max	3 x 100W max
Luminous efficacy	-	-	-
Light distribution	-	-	-
Fitting	G53	G53	G53
Light colour	-	-	-
Light hole	155 x 155 mm	155 x 345 mm	155 x 520 mm
Voltage connection	By driver (optional)	By driver (optional)	By driver (optional)
CRI	-	-	-
Emergency	-	-	-
Energy efficiency class	A	A	A
Note	-	-	-

OPTIONAL ACCESSORIES

product code	optional code	description	info
6061.AC	H8105	Dimmable electronic transformer	Max watt 105W Volts · Hz 230/12V · 50/60Hz
	00010KIT	Kit LED dimmable	Bulb 10W · 12V
6071.AC	H8105	Dimmable electronic transformer	Max watt 105W Volts · Hz 230/12V · 50/60Hz You need n°2 ballast code H8105 for n°1 code 6071.AC
	00010KIT	Kit LED dimmable	Bulb 10W · 12V
6081.AC	H8105	Dimmable electronic transformer	Max watt 105W Volts · Hz 230/12V · 50/60Hz
	00010KIT	Kit LED dimmable	Bulb 10W · 12V

* The absorption capacity per m² calculated by the American organization TCNA (Tile Council of North America) is measured for an average room of 2.7 m in height and therefore expressed in m²



WHITE BOX



INCASSO ORIENTABILE A 1,2 O 3 PUNTI LUCE
E MINIMO INGOMBRO.

Un box prezioso da cui il fascio luminoso si sprigiona determinato: White Box, apparecchio per interni a scomparsa totale in AirCoral® per installazione in soffitto di cartongesso, grazie alla posizione arretrata delle sorgenti luminose, è pensato per avere il minimo impatto visivo all'interno del progetto architettonico, trasformando la luce in pura emozione. Disponibile nella versione singola, doppia e tripla, White Box è il prodotto ideale per valorizzare, attraverso la luce, dettagli, oggetti o situazioni in modo deciso.

*ADJUSTABLE RECESSED LIGHT WITH 1, 2 OR 3 LIGHT
POINTS AND MINIMUM DIMENSIONS.*

A precious box that emits a beam of light in a determined way: White Box, an indoor totally disappearing recessed luminaire made of AirCoral® and installable on plasterboard ceilings, is designed for having a minimal visual impact on the architectonic project, transforming light into pure emotion. This is possible thanks to the rearward position of the light sources. Available in three versions — single, double or triple —, White Box is the ideal product to incisively valorize details, objects and settings through light.

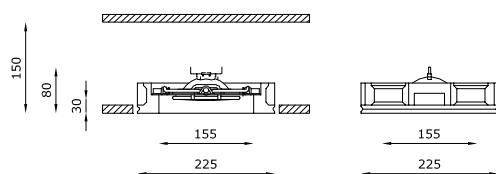

A

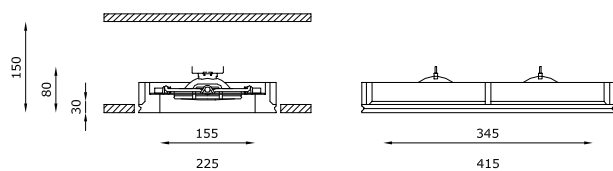



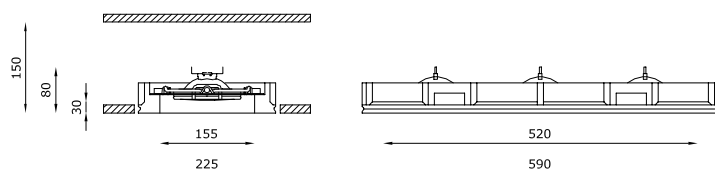



B



C

WITHOUT REAR BOX

TECHNICAL FEATURES

Code	6066.AC (fig. A)	6076.AC (fig. B)	6086.AC (fig. C)
Type	Tiltable downlight $\pm 40^\circ$ 	Tiltable downlight $\pm 40^\circ$ 	Tiltable downlight $\pm 40^\circ$ 
Material	AC: AirCoral®	AC: AirCoral®	AC: AirCoral®
Absorption capacity*	4.55 m ²	6.75 m ²	8.95 m ²
Weight	3.2 Kg	4.2 Kg	4.6 Kg
Mounting	Ceiling recessed	Ceiling recessed	Ceiling recessed
IP rating	IP20	IP20	IP20
Insulation class	III	III	III
Control gear	Electronic transformer (not included)	Electronic transformer (not included)	Electronic transformer (not included)
Cut out for plasterboard	235 x 235 mm	235 x 425 mm	235 x 600 mm
Lamp type	QR 111 	QR 111 	QR 111 
Lamp wattage	1 x 100W max	2 x 100W max	3 x 100W max
Luminous efficacy	-	-	-
Light distribution	-	-	-
Fitting	G53	G53	G53
Light colour	-	-	-
Light hole	155 x 155 mm	155 x 345 mm	155 x 520 mm
Voltage connection	By driver (optional)	By driver (optional)	By driver (optional)
CRI	-	-	-
Emergency	-	-	-
Energy efficiency class	A	A	A
Note	-	-	-

Optional accessories on page 171

* The absorption capacity per m² calculated by the American organization TCNA (Tile Council of North America) is measured for an average room of 2.7 m in height and therefore expressed in m²



Angelo Coppola Showroom - Arch. M. Rosa - Arketipo Design - Monza

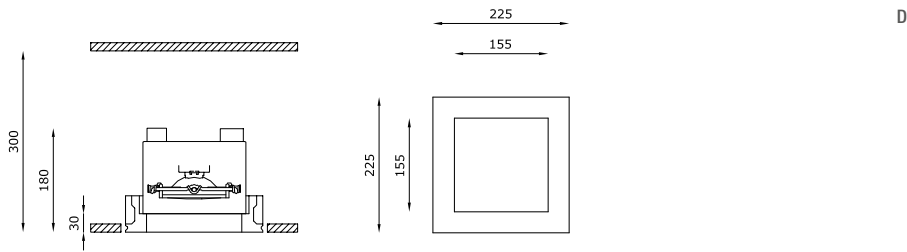

D

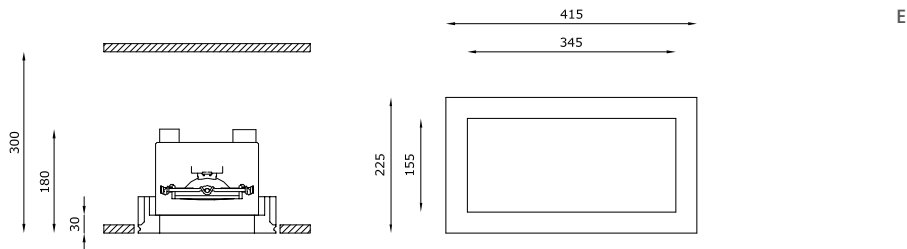

E

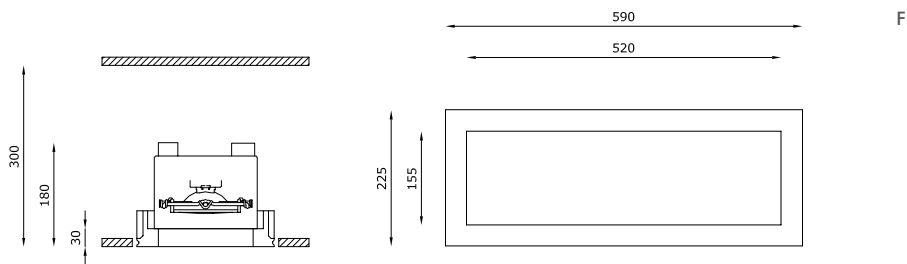

F

WITH REAR BOX

OPTIONAL ACCESSORIES

<i>product code</i>	<i>optional code</i>	<i>description</i>	<i>info</i>
6066.AC	H8105	Dimmable electronic transformer	Max watt 105W Volts · Hz 230/12V · 50/60Hz
	00010KIT	Kit LED dimmable	Bulb 10W · 12V
	H3535	Rear box	see fig. D
6076.AC	H8105	Dimmable electronic transformer	Max watt 105W Volts · Hz 230/12V · 50/60Hz You need n°2 ballast code H8105 for n°1 code 6076.AC
	00010KIT	Kit LED dimmable	Bulb 10W · 12V
	H3536	Rear box	see fig. E
6086.AC	H8105	Dimmable electronic transformer	Max watt 105W Volts · Hz 230/12V · 50/60Hz
	00010KIT	Kit LED dimmable	Bulb 10W · 12V
	H3537	Rear box	see fig. F

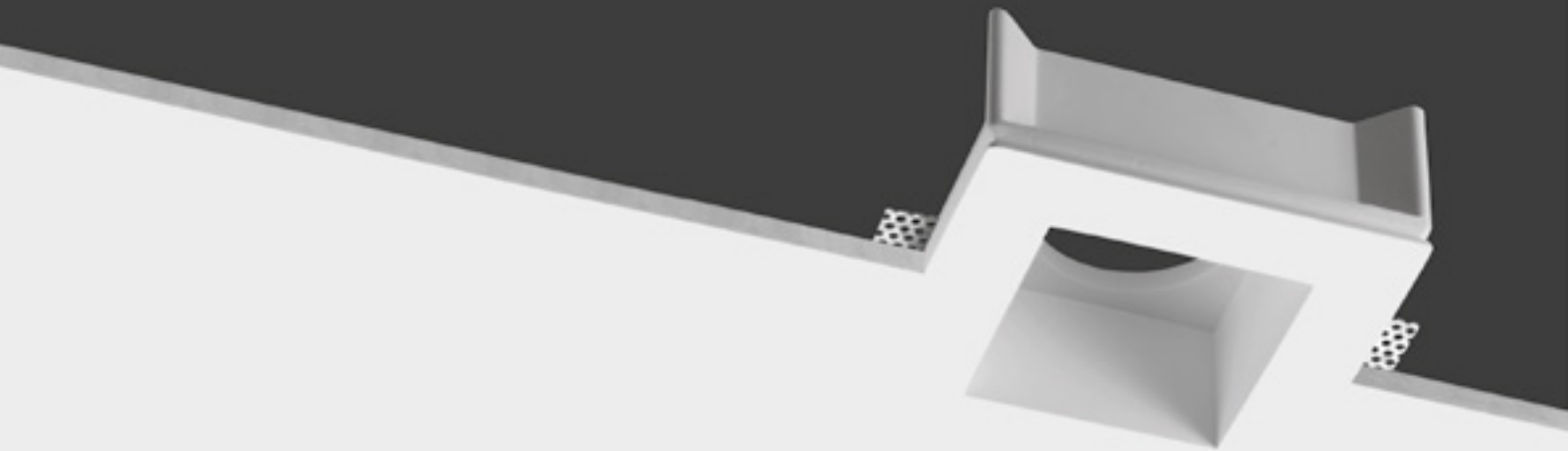

ALKABOX



UN BOX PER MOLTEPLICI FARETTI.

Alkabox, apparecchio da interni, incasso installabile in soffitti di cartongesso, un "case" vuoto atto ad accogliere i faretti ad incasso adatti ad ogni necessità, risultando in uno straordinario effetto di totale scomparsa grazie a linee pulite e design essenziale. Il prodotto è disponibile in 3 versioni a seconda delle esigenze: adatto ad ospitare faretti da incasso standard con dimensioni Ø 73/158 mm e ghiera max Ø 88/178 mm. Coniugando un'estrema versatilità a uno stile unico, Alkabox dona carattere agli ambienti in cui viene installato. Realizzato in Coral[®], risulta estremamente liscio al tatto e allo stesso tempo resistente agli urti e ai graffi.

A BOX FOR MULTIPLE SPOTLIGHTS.

Alkabox, an indoor recessed luminaire, installable on plasterboard ceilings, and fit for multiple types of reflectors thanks to its whole "case". It is able to achieve an extraordinary effect of total disappearance thanks to its clean lines and essential design.

Available in 3 versions depending on the necessity: with Ø 73/158 mm body dimensions and max Ø 88/178 mm ferrule, the product combines an extreme versatility to a unique style, to characterize the spaces it is installed in. Made of Coral[®], it is very smooth to the touch yet very resistant to shocks and scratches.

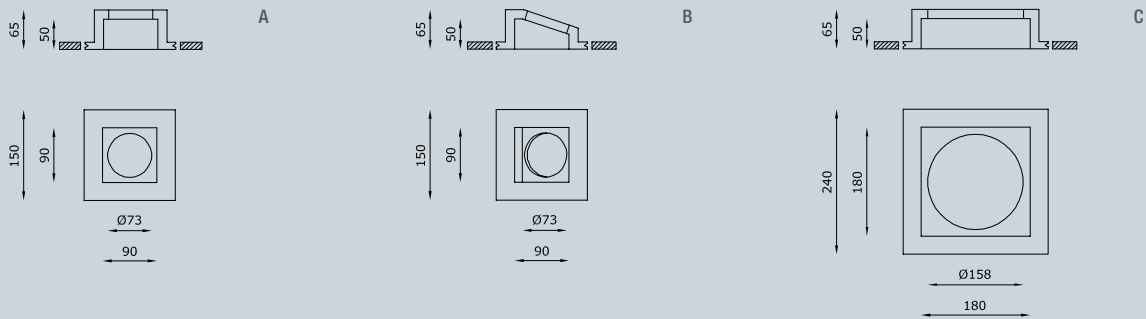

TECHNICAL FEATURES

Code	6211.00 (fig. A)	6221.00 (fig. B)	6231.00 (fig. C)
Type	Downlight 90°	Downlight 90°	Downlight 90°
Material	00: Coral®	00: Coral®	00: Coral®
Weight	0.8 Kg	0.85 Kg	0.85 Kg
Mounting	Ceiling recessed	Ceiling recessed	Ceiling recessed
IP rating	-	-	-
Insulation class	-	-	-
Control gear	-	-	-
Cut out for plasterboard	160 x 160 mm	160 x 160 mm	250 x 250 mm
Lamp type	-	-	-
Lamp wattage	-	-	-
Luminous efficacy	-	-	-
Light distribution	-	-	-
Fitting	-	-	-
Light colour	-	-	-
Light hole	90 x 90 mm	90 x 90 mm	180 x 180 mm
Voltage connection	-	-	-
CRI	-	-	-
Emergency	-	-	-
Energy efficiency class	-	-	-
Note	Box for the mounting at 90° of a recessed luminaire. Adapted for recessed luminaires of any type and brand with metal ring of max Ø 88 mm and hole for recessed luminaire of Ø 73 mm.	Box for the mounting at 30° of a recessed luminaire. Adapted for recessed luminaires of any type and brand with metal ring of max Ø 88 mm and hole for recessed luminaire of Ø 73 mm.	Box for the mounting at 90° of a recessed luminaire. Adapted for recessed luminaires of any type and brand with metal ring of max Ø 178 mm and hole for recessed luminaire of Ø 158 mm.

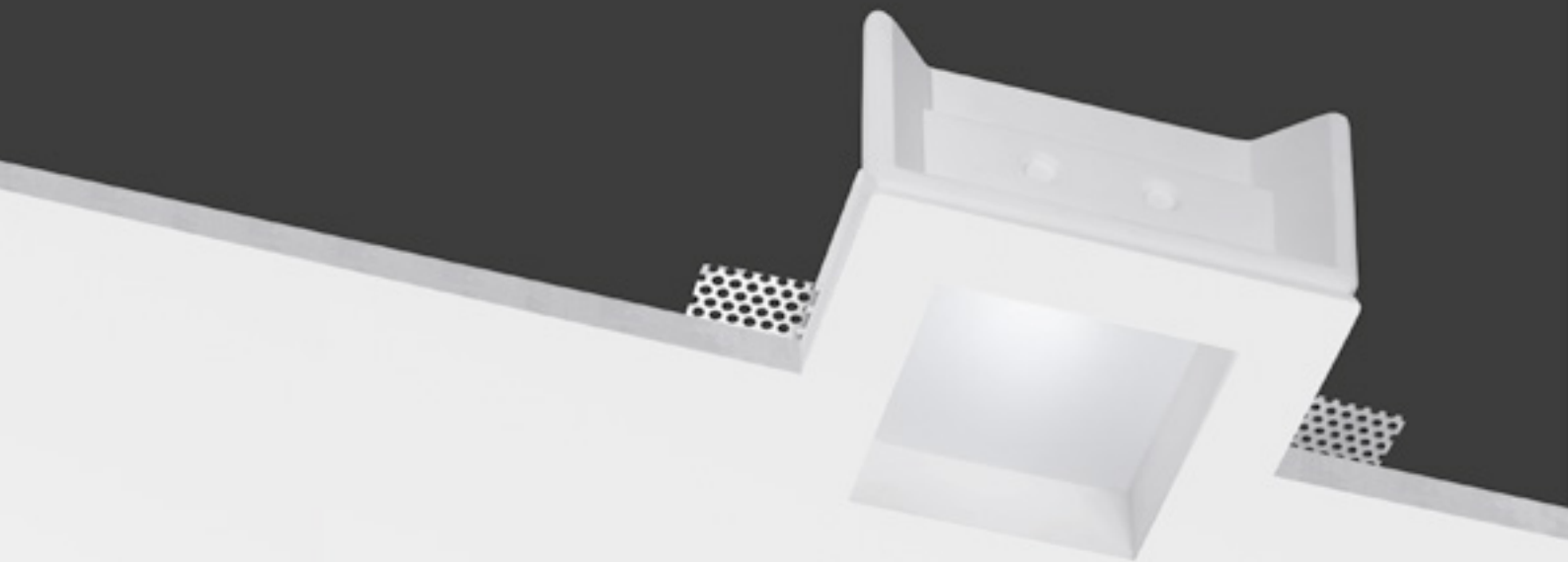

NEFI



INCASSO CON VETRO RETROCESSO,
MASSIMA INVISIBILITÀ.







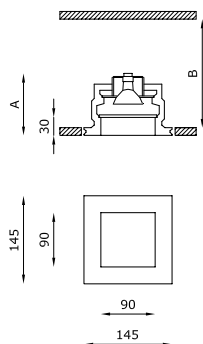

Un fascio luminoso che attraversa il buio, determinando un nuovo equilibrio nello spazio abitativo. Luce e ombra si alternano, giocano con gli arredi, fondono e compongono atmosfere dal fascino unico e delicato: Nefi, apparecchio da interni a scomparsa totale in AirCoral® per installazione in soffitto di cartongesso o laterizio, è dotato di un vetro satinato per un'armoniosa diffusione della luce. Design e tecnologia, geometria ed eleganza per inondare gli ambienti di luce viva.

*RECESSED FITTING WITH REAR GLASS,
MAXIMUM INVISIBILITY.*

A light beam that breaks darkness, establishing a new balance inside the living space. Light and shadows alternate, playing with furniture, creating atmospheres with a unique and delicate charm: Nefi, a totally disappearing indoor recessed luminaire made of AirCoral®, installable on plasterboard or brick ceilings, is equipped with a satined glass, creating an armonious diffusion of light. Design and technology, geometry and elegance to flood the space with bright light.



TECHNICAL FEATURES

Code	6218.Z.AC	6219.Z.AC	6261.AC	6262.AC
Type	Downlight 90° 	Downlight 90° 	Downlight 90° 	Downlight 90° 
Material	AC: AirCoral®	AC: AirCoral®	AC: AirCoral®	AC: AirCoral®
Absorption capacity*	4.07 m ²	4.07 m ²	4.07 m ²	4.07 m ²
Weight	1.6 Kg	2.1 Kg	1.4 Kg	1.5 Kg
Mounting	Ceiling recessed	Ceiling recessed	Ceiling recessed	Ceiling recessed
IP rating	IP40	IP40	IP40	IP40
Insulation class	III	III	III	I
Control gear	Constant current electronic driver (not included)	Constant current electronic driver	Electronic transformer (not included)	-
Dimensions	A: 140 mm; B: 160 mm	A: 140 mm; B: 160 mm	A: 120 mm; B: 160 mm	A: 120 mm; B: 160 mm
Cut out for plasterboard	155 x 155 mm	155 x 155 mm	155 x 155 mm	155 x 155 mm
Lamp type	LED 500 mA  Vf: 18 VDC	LED 500 mA 	QR CB 51 	QPAR 16 
Lamp wattage	1 x 9W	1 x 9W	1 x 50W max	1 x 50W max
Luminous efficacy	1125 lm - 3000K	1125 lm - 3000K	-	-
Light distribution	Wide beam 40°	Wide beam 40°	-	-
Fitting	-	-	GU5.3	GU10
Light colour	White 3000K White 2700K I 4000K (on request)	White 3000K White 2700K I 4000K (on request)	-	-
Light hole	90 x 90 mm	90 x 90 mm	90 x 90 mm	90 x 90 mm
Voltage connection	By driver (optional)	220-240V · 50/60Hz	By driver (optional)	220-240V · 50/60Hz
CRI	>90	>90	-	-
Emergency	-	1 hour	-	-
Energy efficiency class	A++	A++	A	A
Note	Extra white satin glass. Frosted glass recessed 30 mm into the ceiling. On request available dimmable PUSH or DALI.	Extra white satin glass. Frosted glass recessed 30 mm into the ceiling.	Extra white satin glass. Frosted glass recessed 30 mm into the ceiling.	Extra white satin glass. Frosted glass recessed 30 mm into the ceiling.

OPTIONAL ACCESSORIES

product code	optional code	description	info
6218.Z.AC	H8500.E	Constant current electronic driver	Suitable for n°2 code 6218.Z.AC - 500 mA
	H8500.B	Constant current electronic driver	Suitable for n°1 code 6218.Z.AC - 500 mA
	BR6218LT	Brick box	Dimensions L: 195 mm; W: 160 mm; D: 160 mm (instructions on page 502)
6261.AC	H8060.LED	Dimmable electronic transformer	Max watt 60W Volts · Hz 230/12V · 50/60Hz
	0008KIT	Kit LED dimmable	Bulb 7W · 12V
	BR6261LT	Brick box	Dimensions L: 195 mm; W: 160 mm; D: 160 mm (instructions on page 502)
6262.AC	0009KIT	Kit LED dimmable	Bulb 6W · 220-240V
	BR6262LT	Brick box	Dimensions L: 195 mm; W: 160 mm; D: 160 mm (instructions on page 502)

* The absorption capacity per m² calculated by the American organization TCNA (Tile Council of North America) is measured for an average room of 2,7 m in height and therefore expressed in m²



Private villa - ph. T. Pagani - Lugano





NIMBUS



INCASSO CON VETRO RETROCESSO,
MASSIMA INVISIBILITÀ.

Apparecchio da interni a scomparsa totale in AirCoral® per installazione in soffitto di cartongesso o laterizio, Nimbus è pensato per diventare parte integrante del soffitto e scomparire completamente alla vista una volta installato. Il vetro satinato diffonde la luce nell'ambiente, così da valorizzarne gli spazi, trasformandoli ogni volta in uno spettacolo da scoprire, determinando precisi percorsi di luce caratterizzati da uno stile esclusivo che parla la lingua del design.

*RECESSED FITTING WITH REAR GLASS,
MAXIMUM INVISIBILITY.*

A recessed indoor system made of AirCoral® for plasterboard or brick ceilings designed to become an integral part of the ceiling, Nimbus is completely disappearing from the view once installed. Its satin glass diffuses light in the environment, enhancing the spaces, transforming them in a sight to rediscover every time, defining precise light paths with a distinctive style that speaks the language of design.

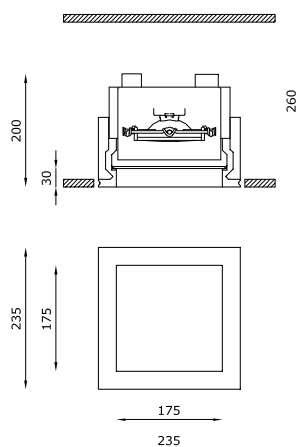



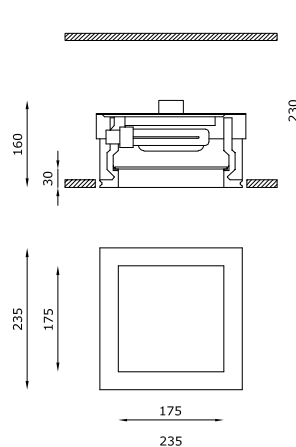







A



B

TECHNICAL FEATURES

Code	6271.AC (fig. A)	6276.AC (fig. B)	6285.AC (fig. B)	6281.AC (fig. B)	6283.AC (fig. B)
Type	Tiltable downlight ± 30° 	Downlight 90° 	Downlight 90° 	Downlight 90° 	Downlight 90° 
Material	AC: AirCoral®	AC: AirCoral®	AC: AirCoral®	AC: AirCoral®	AC: AirCoral®
Absorption capacity*	6.82 m²	6.82 m²	6.82 m²	6.82 m²	6.82 m²
Weight	4.1 Kg	3.8 Kg	4.1 Kg	3 Kg	3 Kg
Mounting	Ceiling recessed	Ceiling recessed	Ceiling recessed	Ceiling recessed	Ceiling recessed
IP rating	IP40	IP40	IP40	IP40	IP40
Insulation class	III	I	I	I	I
Control gear	Dimmable electronic transformer	Electronic ballast	Electronic ballast	Constant current electronic driver	Dimmable constant current driver
Cut out for plasterboard	245 x 245 mm	245 x 245 mm	245 x 245 mm	245 x 245 mm	245 x 245 mm
Lamp type	QR 111 	TC-TEL 	TC-TEL 	LED 1050 mA 	LED 350 mA 
Lamp wattage	1 x 100W max	2 x 26/32W	2 x 26W	1 x 40W	2 x 6.5W
Luminous efficacy	-	-	-	4680 lm - 3000K	2 x 810 lm - 3000K
Light distribution	-	-	-	Wide beam 40°	Wide beam 120°
Fitting	G53	Gx24q-3	Gx24q-3	-	-
Light colour	-	-	-	White 3000K White 2700K 4000K (on request)	White 3000K White 2700K 4000K (on request)
Light hole	175 x 175 mm	175 x 175 mm	175 x 175 mm	175 x 175 mm	175 x 175 mm
Voltage connection	220-240V / 12V · 50/60Hz	220-240V · 50/60Hz	220-240V · 50/60Hz	220-240V · 50/60Hz	220-240V · 50/60Hz
CRI	-	-	-	>90	>90
Emergency	-	-	1 hour	-	-
Energy efficiency class	A	A	A	A++	A+
Note	Extra white satin glass with transparent central part Ø 110 mm. Frosted glass recessed 30 mm into the ceiling.	Extra white satin glass. Frosted glass recessed 30 mm into the ceiling.	Extra white satin glass. Frosted glass recessed 30 mm into the ceiling.	Extra white satin glass. Frosted glass recessed 30 mm into the ceiling.	Extra white satin glass. Frosted glass recessed 30 mm into the ceiling. Trailing-edge and leading-edge dimming (20 - 100%).

OPTIONAL ACCESSORIES

product code	optional code	description	info
6271.AC	00010KIT	Kit LED dimmable	Bulb 10W · 12V
6276.AC	BR6276LT	Brick box	Dimensions L: 445 mm; W: 250 mm; D: 180 mm (instructions on page 502)
6283.AC	BR6283LT	Brick box	Dimensions L: 445 mm; W: 250 mm; D: 180 mm (instructions on page 502)

* The absorption capacity per m² calculated by the American organization TCNA (Tile Council of North America) is measured for an average room of 2,7 m in height and therefore expressed in m²



Private villa - ph. G. Doppiu - Olbia



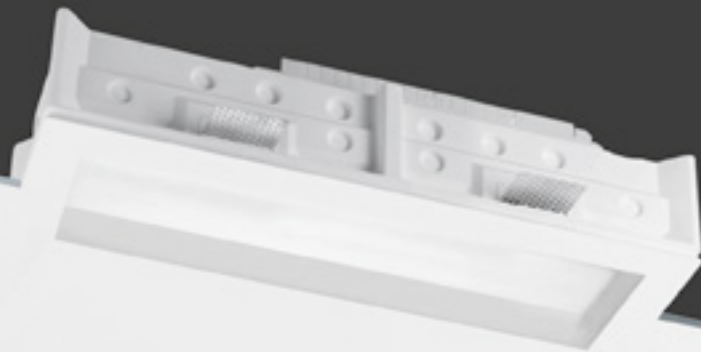

TEKNO



INCASSO CON VETRO RETROCESSO,
MASSIMA INVISIBILITÀ.

La tecnologia si trasforma in emozione grazie a Tekno, incasso a scomparsa totale da interni in AirCoral® per installazione in soffitto di cartongesso o laterizio che, con la sua luce, avvolge gli ambienti trasmettendo sensazioni di delicato benessere e armonia.

Un design pulito ed essenziale per dare assoluto risalto all'effetto luminoso che, senza nessuna esitazione, valorizza gli spazi e gli arredi.



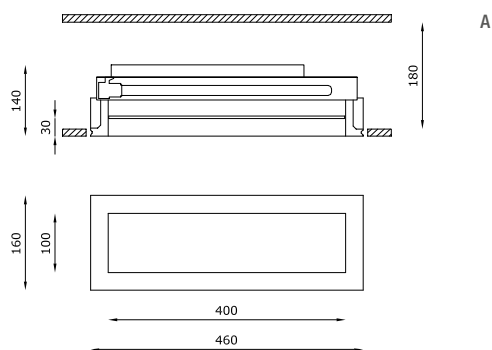

*RECESSED FITTING WITH REAR GLASS,
MAXIMUM INVISIBILITY.*

Technology becomes emotion thanks to Tekno, a totally disappearing recessed luminaire made of AirCoral®, installable on plasterboard or brick ceilings: with its light, it wraps spaces up spreading sensation of delicate well-being and harmony.

A clean and essential design to give absolute prominence to the lit effect which, with no hesitation, enhances spaces and furniture.



TECHNICAL FEATURES

Code	6034.AC (fig. A)	6036.AC (fig. A)	6038.PAC (fig. A)	6051.AC (fig. A)	6052.AC (fig. A)
Type	Downlight 90°	Downlight 90°	Downlight 90°	Downlight 90°	Downlight 90°
Material	AC: AirCoral®	AC: AirCoral®	AC: AirCoral®	AC: AirCoral®	AC: AirCoral®
Absorption capacity*	11.04 m²	11.04 m²	11.04 m²	11.04 m²	11.04 m²
Weight	4.7 Kg	5.5 Kg	5.9 Kg	6 Kg	6 Kg
Mounting	Ceiling recessed	Ceiling recessed	Ceiling recessed	Ceiling recessed	Ceiling recessed
IP rating	IP40	IP40	IP40	IP40	IP40
Insulation class	I	I	I	III	III
Control gear	Electronic ballast	Electronic ballast	Dimmable electronic ballast	Constant current electronic driver	Constant current electronic driver
Cut out for plasterboard	170 x 470 mm	170 x 470 mm	170 x 470 mm	170 x 470 mm	170 x 470 mm
Lamp type	TC-L 	TC-L 	TC-L 	LED 350 mA 	LED 350 mA 
Lamp wattage	1 x 36W	1 x 36W	1 x 36W	1 x 12W	2 x 12W
Luminous efficacy	-	-	-	1640 lm - 3000K	2 x 1640 lm - 3000K
Light distribution	-	-	-	Wide beam 120°	Wide beam 120°
Fitting	2G11	2G11	2G11	-	-
Light colour	-	-	-	White 3000K White 2700K 4000K (on request)	White 3000K White 2700K 4000K (on request)
Light hole	100 x 400 mm	100 x 400 mm	100 x 400 mm	100 x 400 mm	100 x 400 mm
Voltage connection	220-240V · 50/60Hz	220-240V · 50/60Hz	220-240V · 50/60Hz	220-240V · 50/60Hz	220-240V · 50/60Hz
CRI	-	-	-	>90	>90
Emergency	-	1 hour	-	-	-
Energy efficiency class	A	A	A	A+	A+
Note	Extra white satin glass. Frosted glass recessed 30 mm into the ceiling.	Extra white satin glass. Frosted glass recessed 30 mm into the ceiling.	Extra white satin glass. Frosted glass recessed 30 mm into the ceiling.	Extra white satin glass. Frosted glass recessed 30 mm into the ceiling.	Extra white satin glass. Frosted glass recessed 30 mm into the ceiling.

Standard: dimmable switch dim. / push (on request: dimmable 1-10V or DALI).





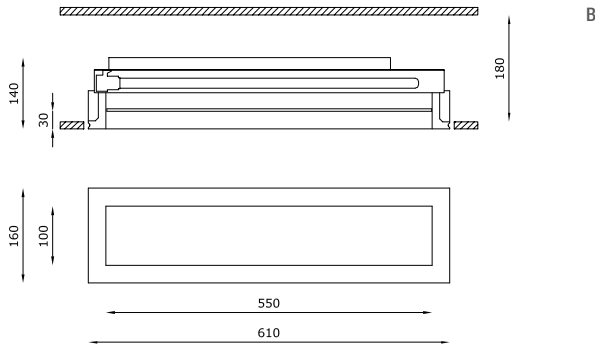

OPTIONAL ACCESSORIES

product code	optional code	description	info
6034.AC	BR6034LT	Brick box	Dimensions L: 570 mm; W: 170 mm; D: 160 mm (instructions on page 502)
6036.AC	BR6036LT	Brick box	Dimensions L: 570 mm; W: 170 mm; D: 160 mm (instructions on page 502)
6038.PAC	BR6038PLT	Brick box	Dimensions L: 570 mm; W: 170 mm; D: 160 mm (instructions on page 502)
6051.AC	BR6051LT	Brick box	Dimensions L: 570 mm; W: 170 mm; D: 160 mm (instructions on page 502)
6052.AC	BR6052LT	Brick box	Dimensions L: 570 mm; W: 170 mm; D: 160 mm (instructions on page 502)

* The absorption capacity per m² calculated by the American organization TCNA (Tile Council of North America) is measured for an average room of 2.7 m in height and therefore expressed in m²



TECHNICAL FEATURES

Code	6025.AC (fig. B)	6027.AC (fig. B)	6029.PAC (fig. B)
Type	Downlight 90° 	Downlight 90° 	Downlight 90° 
Material	AC: AirCoral®	AC: AirCoral®	AC: AirCoral®
Absorption capacity*	13.95 m ²	13.95 m ²	13.95 m ²
Weight	5.4 Kg	6.2 Kg	6.4 Kg
Mounting	Ceiling recessed	Ceiling recessed	Ceiling recessed
IP rating	IP40	IP40	IP40
Insulation class	I	I	I
Control gear	Electronic ballast	Electronic ballast	Dimmable electronic ballast
Cut out for plasterboard	170 x 620 mm	170 x 620 mm	170 x 620 mm
Lamp type	TC-L 	TC-L 	TC-L 
Lamp wattage	1 x 55W	1 x 55W	1 x 55W
Luminous efficacy	-	-	-
Light distribution	-	-	-
Fitting	2G11	2G11	2G11
Light colour	-	-	-
Light hole	100 x 550 mm	100 x 550 mm	100 x 550 mm
Voltage connection	220-240V · 50/60Hz	220-240V · 50/60Hz	220-240V · 50/60Hz
CRI	-	-	-
Emergency	-	1 hour	-
Energy efficiency class	A	A	A
Note	Extra white satin glass. Frosted glass recessed 30 mm into the ceiling.	Extra white satin glass. Frosted glass recessed 30 mm into the ceiling.	Extra white satin glass. Frosted glass recessed 30 mm into the ceiling. Standard: dimmable switch dim. / push (on request: dimmable 1-10V or DALI).

OPTIONAL ACCESSORIES

product code	optional code	description	info
6025.AC	BR6025LT	Brick box	Dimensions L: 720 mm; W: 170 mm; D: 160 mm (instructions on page 502)
6027.AC	BR6027LT	Brick box	Dimensions L: 720 mm; W: 170 mm; D: 160 mm (instructions on page 502)
6029.PAC	BR6029PLT	Brick box	Dimensions L: 720 mm; W: 170 mm; D: 160 mm (instructions on page 502)



Dental Clinic - Padova

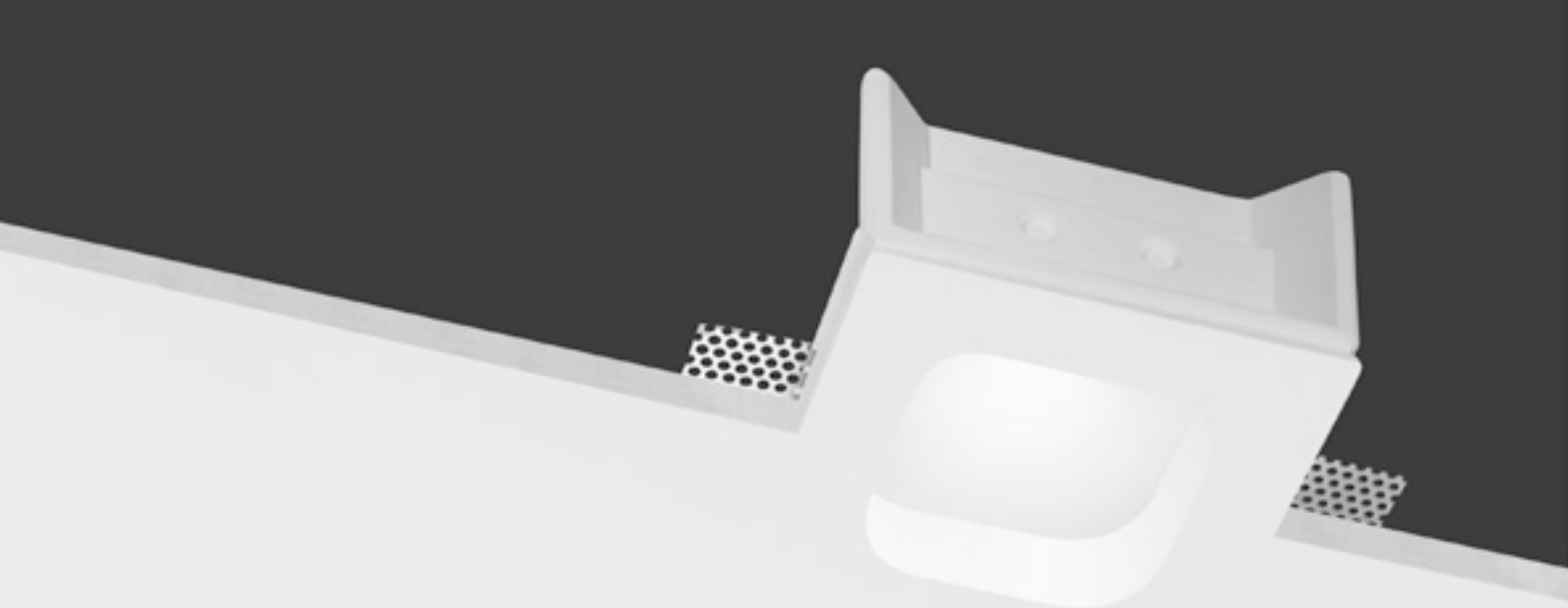

FOCUS



INCASSO CON VETRO RETROCESSO E FORME SINUOSE.

Un prodotto che delinea la strada dell'architettura contemporanea, con le sue linee pulite e il design geometrico: Focus, un apparecchio da interni, un incasso a scomparsa totale per installazione a soffitto di cartongesso o laterizio. Il prodotto scompare, per dare spazio solo al fascio luminoso, che illumina, evidenzia e arreda gli spazi in cui viene installato. Il corpo di Focus è realizzato in AirCoral®, per una perfetta combinazione di design e tecnologia all'avanguardia, attenta all'ambiente e alla qualità dell'aria che respiriamo.

RECESSED FITTING WITH REAR GLASS AND SINUOUS SHAPES.

Outlining the path of contemporary architecture, with its clean lines and geometric design: through its light Focus, a totally disappearing indoor recessed luminaire, installable on plasterboard or brick ceilings. This product disappears, in order to give way to the light beam alone, which lights up, points out and decorates the spaces it is installed in. The body of Focus is made of AirCoral®, for a perfect combination of design and cutting-edge technology, with particular attention to the environment and air quality.

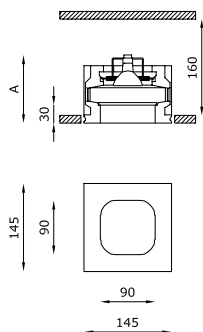

TECHNICAL FEATURES

Code	6163.Z.AC	6169.Z.AC	6161.AC	6162.AC
Type	Downlight 90° 	Downlight 90° 	Downlight 90° 	Downlight 90°
Material	AC: AirCoral®	AC: AirCoral®	AC: AirCoral®	AC: AirCoral®
Absorption capacity*	4.05 m ²	4.05 m ²	4.05 m ²	4.05 m ²
Weight	1.8 Kg	2.3 Kg	1.7 Kg	1.7 Kg
Mounting	Ceiling recessed	Ceiling recessed	Ceiling recessed	Ceiling recessed
IP rating	IP40	IP40	IP40	IP40
Insulation class	III	III	III	I
Control gear	Constant current electronic driver (not included)	Constant current electronic driver	Electronic transformer (not included)	-
Dimensions	A: 140 mm	A: 140 mm	A: 120 mm	A: 120 mm
Cut out for plasterboard	155 x 155 mm	155 x 155 mm	155 x 155 mm	155 x 155 mm
Lamp type	LED 500 mA Vf: 18 VDC	LED 500 mA 	QR CB 51 	QPAR 16
Lamp wattage	1 x 9W	1 x 9W	1 x 50W max	1 x 50W max
Luminous efficacy	1125 lm - 3000K	1125 lm - 3000K	-	-
Light distribution	Wide beam 40°	Wide beam 40°	-	-
Fitting	-	-	GU5.3	GU10
Light colour	White 3000K White 2700K I 4000K (on request)	White 3000K White 2700K I 4000K (on request)	-	-
Light hole	90 x 90 mm	90 x 90 mm	90 x 90 mm	90 x 90 mm
Voltage connection	By driver (optional)	220-240V · 50/60Hz	By driver (optional)	220-240V / 12V · 50/60Hz
CRI	>90	>90	-	-
Emergency	-	1 hour	-	-
Energy efficiency class	A++	A++	A	A
Note	Extra white satin glass. Frosted glass recessed 30 mm into the ceiling. On request available dimmable PUSH or DALI.	Extra white satin glass. Frosted glass recessed 30 mm into the ceiling.	Extra white satin glass. Frosted glass recessed 30 mm into the ceiling.	Extra white satin glass. Frosted glass recessed 30 mm into the ceiling.

OPTIONAL ACCESSORIES

product code	optional code	description	info
6163.Z.AC	H8500.E	Constant current electronic driver	Suitable for n°2 code 6163.Z.AC - 500 mA
	H8500.B	Constant current electronic driver	Suitable for n°1 code 6163.Z.AC - 500 mA
	BR6163LT	Brick box	Dimensions L: 195 mm; W: 160 mm; D: 160 mm (instructions on page 502)
6161.AC	H8060.LED	Dimmable electronic transformer	Max watt 60W Volts · Hz 230/12V · 50/60Hz
	0008KIT	Kit LED dimmable	Bulb 7W · 12V
	BR6161LT	Brick box	Dimensions L: 195 mm; W: 160 mm; D: 160 mm (instructions on page 502)
6162.AC	0009KIT	Kit LED dimmable	Bulb 6W · 220-240V
	BR6162LT	Brick box	Dimensions L: 195 mm; W: 160 mm; D: 160 mm (instructions on page 502)

* The absorption capacity per m² calculated by the American organization TCNA (Tile Council of North America) is measured for an average room of 2.7 m in height and therefore expressed in m²

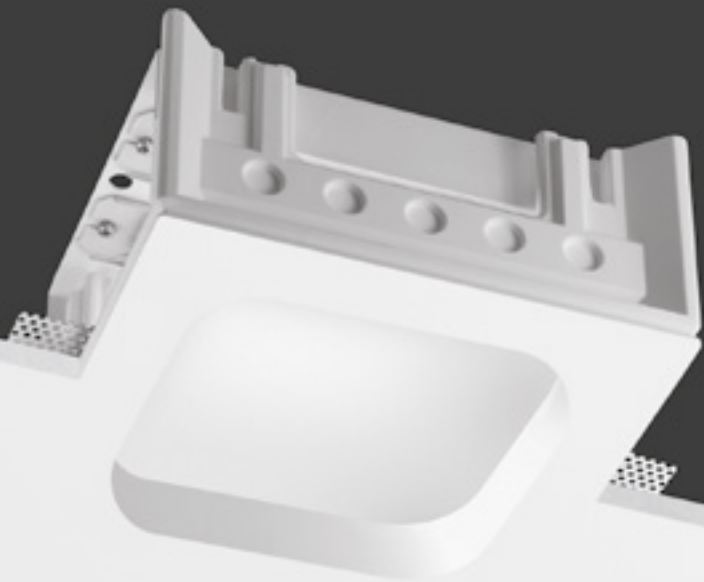

ZOOM



INCASSO CON VETRO RETROCESSO E FORME SINUOSE.







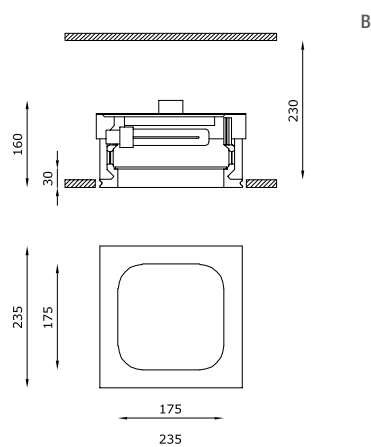
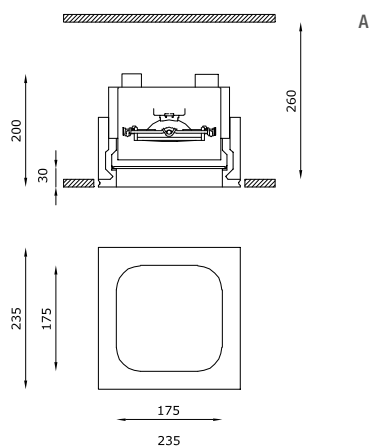



Luce che valorizza i dettagli, che illumina con delicatezza, per arredare in modo innovativo: Zoom è un incasso da interni a scomparsa totale per installazione in soffitto di cartongesso. Il corpo in AirCoral® è pensato per diventare parte integrante del controsoffitto e sparire completamente alla vista, in modo da dare assoluta importanza al fascio luminoso.

RECESSED FITTING WITH REAR GLASS AND SINUOUS SHAPES.

A light that enhances details, that illuminates gently, to decorate in an innovative way: Zoom is an indoor totally disappearing recessed luminaire, installable on plasterboard ceilings. Its body in AirCoral® is designed to become an integral part of the plasterboard ceiling and to completely disappear from the view in order to give absolute importance to the light beam.



TECHNICAL FEATURES

Code	6171.AC (fig. A)	6176.AC (fig. B)	6185.AC (fig. B)	6181.AC (fig. B)	6183.AC (fig. B)
Type	Tilttable downlight $\pm 30^\circ$ 	Downlight 90° 	Downlight 90° 	Downlight 90° 	Downlight 90° 
Material	AC: AirCoral®	AC: AirCoral®	AC: AirCoral®	AC: AirCoral®	AC: AirCoral®
Absorption capacity*	7.72 m ²	7.72 m ²	7.72 m ²	7.72 m ²	7.72 m ²
Weight	4.4 Kg	4 Kg	4.2 Kg	3.2 Kg	3.2 Kg
Mounting	Ceiling recessed	Ceiling recessed	Ceiling recessed	Ceiling recessed	Ceiling recessed
IP rating	IP40	IP40	IP40	IP40	IP40
Insulation class	III	I	I	I	I
Control gear	Dimmable electronic transformer	Electronic ballast	Electronic ballast	Constant current electronic driver	Dimmable constant current driver
Cut out for plasterboard	245 x 245 mm	245 x 245 mm	245 x 245 mm	245 x 245 mm	245 x 245 mm
Lamp type	QR 111 	TC-TEL 	TC-TEL 	LED 1050 mA 	LED 350 mA 
Lamp wattage	1 x 100W max	2 x 26/32W	2 x 26W	1 x 40W	2 x 6.5W
Luminous efficacy	-	-	-	4680 lm - 3000K	2 x 810 lm - 3000K
Light distribution	-	-	-	Wide beam 40°	Wide beam 120°
Fitting	G53	Gx24q-3	Gx24q-3	-	-
Light colour	-	-	-	White 3000K White 2700K 4000K (on request)	White 3000K White 2700K 4000K (on request)
Light hole	175 x 175 mm	175 x 175 mm	175 x 175 mm	175 x 175 mm	175 x 175 mm
Voltage connection	220-240V / 12V · 50/60Hz	220-240V · 50/60Hz	220-240V · 50/60Hz	220-240V · 50/60Hz	220-240V · 50/60Hz
CRI	-	-	-	>90	>90
Emergency	-	-	1 hour	-	-
Energy efficiency class	A	A	A	A++	A+
Note	Extra white satin glass. Frosted glass recessed 30 mm into the ceiling.	Extra white satin glass. Frosted glass recessed 30 mm into the ceiling.	Extra white satin glass. Frosted glass recessed 30 mm into the ceiling.	Extra white satin glass. Frosted glass recessed 30 mm into the ceiling.	Extra white satin glass. Frosted glass recessed 30 mm into the ceiling. Trailing-edge and leading-edge dimming (20 - 100%).

OPTIONAL ACCESSORIES

product code	optional code	description	info
6171.AC	00010KIT	Kit LED dimmable	Bulb 10W · 12V

* The absorption capacity per m² calculated by the American organization TCNA (Tile Council of North America) is measured for an average room of 2,7 m in height and therefore expressed in m²

Zoom



Restaurant - Cosenza



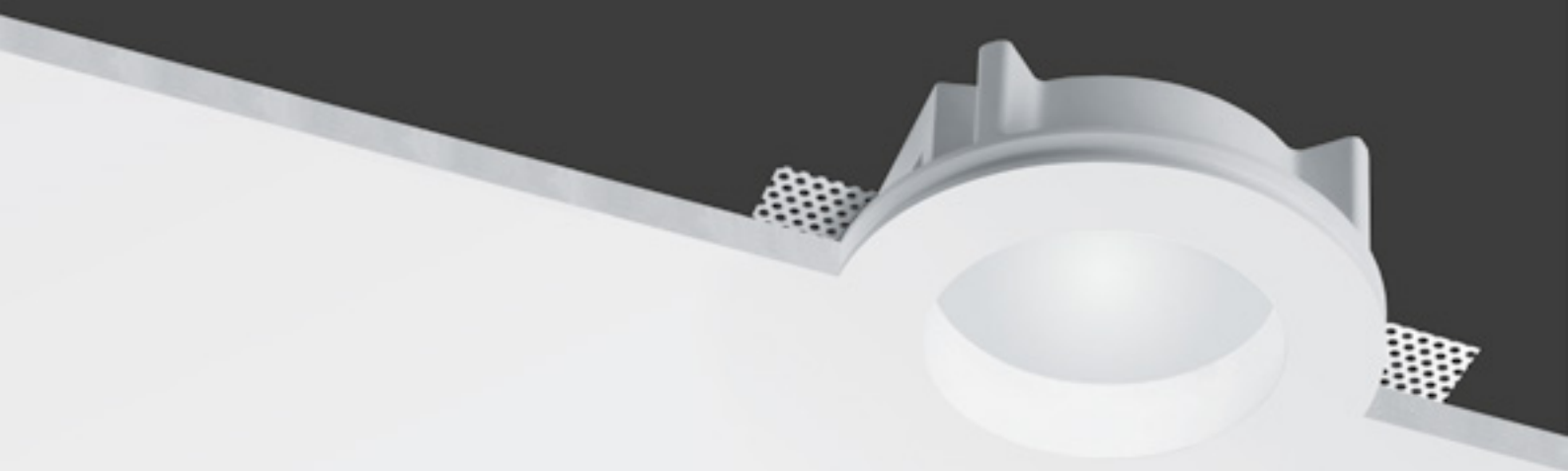

ECLA



INCASSO CON VETRO RETROCESSO,
MASSIMA INVISIBILITÀ.







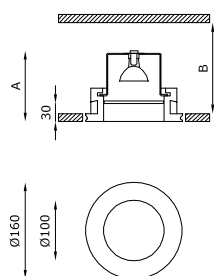

Un prodotto invisibile, un design discreto, una luce unica per infinite soluzioni progettuali: Ecla, è un prodotto da interni in AirCoral[®], un incasso a scomparsa totale per installazione a soffitto di cartongesso o laterizio. L'armonia creata dalla perfetta combinazione tra tecnologia ed eleganza è la caratteristica fondante dell'Ecla. Un unico prodotto, per 3 diversi tipi di sorgenti luminose, la risposta a qualsiasi esigenza progettuale.

*RECESSED FITTING WITH REAR GLASS,
MAXIMUM INVISIBILITY.*

An invisible product, a discreet design, a unique light for infinite project solutions: Ecla, is a totally disappearing indoor recessed luminaire made of AirCoral[®], installable on plasterboard or brick ceilings. The harmony created by the perfect combination of technology and elegance, is the main features of Ecla. A unique line, for 3 different lamp types, the answer to any design need.



TECHNICAL FEATURES

Code	6268.Z.AC	6213.Z.AC	6265.AC	6263.AC
Type	Downlight 90° 	Downlight 90° 	Downlight 90° 	Downlight 90° 
Material	AC: AirCoral®	AC: AirCoral®	AC: AirCoral®	AC: AirCoral®
Absorption capacity*	2.72 m ²	2.72 m ²	2.72 m ²	2.72 m ²
Weight	1.2 Kg	1.7 Kg	1 Kg	1 Kg
Mounting	Ceiling recessed	Ceiling recessed	Ceiling recessed	Ceiling recessed
IP rating	IP40	IP40	IP40	IP40
Insulation class	III	III	III	I
Control gear	Constant current electronic driver (not included)	Constant current electronic driver	Electronic transformer (not included)	-
Dimensions	A: 120 mm; B: 130 mm	A: 120 mm; B: 150 mm	A: 120 mm; B: 150 mm	A: 135 mm; B: 150 mm
Cut out for plasterboard	Ø 170 mm	Ø 170 mm	Ø 170 mm	Ø 170 mm
Lamp type	LED 500 mA  Vf: 18 VDC	LED 500 mA 	QR CB 51 	QPAR 16 
Lamp wattage	1 x 9W	1 x 9W	1 x 50W max	1 x 50W max
Luminous efficacy	1125 lm - 3000K	1125 lm - 3000K	-	-
Light distribution	Wide beam 40°	Wide beam 40°	-	-
Fitting	-	-	GU5.3	GU10
Light colour	White 3000K White 2700K 4000K (on request)	White 3000K White 2700K 4000K (on request)	-	-
Light hole	Ø 100 mm	Ø 100 mm	Ø 100 mm	Ø 100 mm
Voltage connection	By driver (optional)	220-240V · 50/60Hz	By driver (optional)	220-240V · 50/60Hz
CRI	>90	>90	-	-
Emergency	-	1 hour	-	-
Energy efficiency class	A++	A++	A	A
Note	Extra white satin glass. Frosted glass recessed 30 mm into the ceiling. On request available dimmable PUSH or DALI.	Extra white satin glass. Frosted glass recessed 30 mm into the ceiling.	Extra white satin glass. Frosted glass recessed 30 mm into the ceiling.	Extra white satin glass. Frosted glass recessed 30 mm into the ceiling.

OPTIONAL ACCESSORIES

product code	optional code	description	info
6268.Z.AC	H8500.E	Constant current electronic driver	Suitable for n°2 code 6268.Z.AC - 500 mA
	H8500.B	Constant current electronic driver	Suitable for n°1 code 6268.Z.AC - 500 mA
	BR6268LT	Brick box	Dimensions L: 195 mm; W: 160 mm; D: 160 mm (instructions on page 502)
6265.AC	H8060.LED	Dimmable electronic transformer	Max watt 60W Volts · Hz 230/12V · 50/60Hz
	0008KIT	Kit LED dimmable	Bulb 7W · 12V
	BR6265LT	Brick box	Dimensions L: 195 mm; W: 160 mm; D: 160 mm (instructions on page 502)
6263.AC	0009KIT	Kit LED dimmable	Bulb 6W · 220-240V
	BR6263LT	Brick box	Dimensions L: 195 mm; W: 160 mm; D: 160 mm (instructions on page 502)

* The absorption capacity per m² calculated by the American organization TCNA (Tile Council of North America) is measured for an average room of 2.7 m in height and therefore expressed in m²



Armani Casa - Maçka Residences - ph. E. Abrate - Istanbul





ELIOS



INCASSO CON VETRO RETROCESSO,
MASSIMA INVISIBILITÀ.

Un nome evocativo, un design circolare che si integra con l'ambiente in cui viene installato, avvolgendo gli ambienti di luce viva. Elios è un apparecchio illuminante da interni, un incasso a scomparsa totale realizzato in AirCoral® per installazione a soffitto di cartongesso o laterizio. L'armonia delle forme è espressione di assoluta eleganza, la qualità dei materiali è garanzia di durata nel tempo e resistenza, per una luce pura e dallo stile unico.

Elios: luce che illumina e che purifica, esaltando in modo naturale ogni ambiente.

*RECESSED FITTING WITH REAR GLASS,
MAXIMUM INVISIBILITY.*

An evocative name, a circular design that fits in the space it is installed in, enveloping rooms in bright light. Elios is a totally disappearing indoor recessed luminaire made of AirCoral®, installable on plasterboard or brick ceilings. Its purity of shapes is an expression of absolute elegance, the quality of its materials guarantees long duration and resistance, for a pure light and a unique style.

Elios: a light that illuminates and purifies, naturally exalting every space.

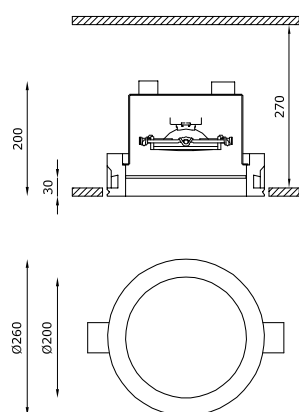



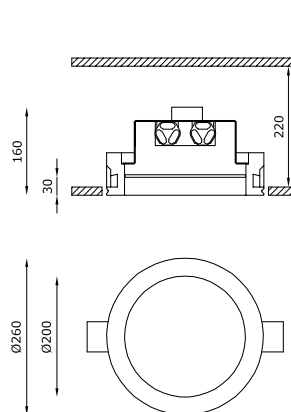







A



B

TECHNICAL FEATURES

Code	6371.AC (fig. A)	6376.AC (fig. B)	6385.AC (fig. B)	6381.AC (fig. B)	6383.AC (fig. B)
Type	Tiltable downlight ± 30° 	Downlight 90° 	Downlight 90° 	Downlight 90° 	Downlight 90° 
Material	AC: AirCoral®	AC: AirCoral®	AC: AirCoral®	AC: AirCoral®	AC: AirCoral®
Absorption capacity*	5.28 m ²	5.28 m ²	5.28 m ²	5.28 m ²	5.28 m ²
Weight	3.6 Kg	3.6 Kg	3.8 Kg	2.6 Kg	2.6 Kg
Mounting	Ceiling recessed	Ceiling recessed	Ceiling recessed	Ceiling recessed	Ceiling recessed
IP rating	IP40	IP40	IP40	IP40	IP40
Insulation class	III	I	I	I	I
Control gear	Dimmable electronic transformer	Electronic ballast	Electronic ballast	Constant current electronic driver	Dimmable constant current driver
Cut out for plasterboard	Ø 270 mm	Ø 270 mm	Ø 270 mm	Ø 270 mm	Ø 270 mm
Lamp type	QR 111 	TC-TEL 	TC-TEL 	LED 1050 mA 	LED 350 mA 
Lamp wattage	1 x 100W max	2 x 26/32W	2 x 26W	1 x 40W	2 x 6.5W
Luminous efficacy	-	-	-	4680 lm - 3000K	2 x 810 lm - 3000K
Light distribution	-	-	-	Wide beam 40°	Wide beam 120°
Fitting	G53	Gx24q-3	Gx24q-3	-	-
Light colour	-	-	-	White 3000K White 2700K 4000K (on request)	White 3000K White 2700K 4000K (on request)
Light hole	Ø 200 mm	Ø 200 mm	Ø 200 mm	Ø 200 mm	Ø 200 mm
Voltage connection	220-240V / 12V · 50/60Hz	220-240V · 50/60Hz	220-240V · 50/60Hz	220-240V · 50/60Hz	220-240V · 50/60Hz
CRI	-	-	-	>90	>90
Emergency	-	-	1 hour	-	-
Energy efficiency class	A	A	A	A++	A+
Note	Extra white satin glass with transparent central part Ø 110 mm. Frosted glass recessed 30 mm into the ceiling.	Extra white satin glass. Frosted glass recessed 30 mm into the ceiling.	Extra white satin glass. Frosted glass recessed 30 mm into the ceiling.	Extra white satin glass. Frosted glass recessed 30 mm into the ceiling.	Extra white satin glass. Frosted glass recessed 30 mm into the ceiling. Trailing-edge and leading-edge dimming (20 - 100%).

OPTIONAL ACCESSORIES

product code	optional code	description	info
6371.AC	00010KIT	Kit LED dimmable	Bulb 10W · 12V
6376.AC	BR6376LT	Brick box	Dimensions L: 445 mm; W: 270 mm; D: 225 mm (instructions on page 502)
6383.AC	BR6383LT	Brick box	Dimensions L: 445 mm; W: 270 mm; D: 225 mm (instructions on page 502)

* The absorption capacity per m² calculated by the American organization TCNA (Tile Council of North America) is measured for an average room of 2,7 m in height and therefore expressed in m²



Madiolanum headquarter - Milan





BILD



MINIMALISMO E SEMPLICITÀ.

Geometria e luce, eleganza e semplicità: Bild è incasso a scomparsa totale da interni con corpo in Coral® per l'installazione a soffitto di cartongesso o laterizio. La linearità diventa base di partenza per realizzare soluzioni uniche, dove il fascio di luce diventa protagonista assoluto all'interno degli ambienti. L'assenza di viti o ghiera nel corpo dell'apparecchio consente straordinari risultati di scomparsa totale: l'apparecchio diventa parte integrante delle superfici in cui viene installato. Il vetro, satinato e recesso, posato in appoggio senza l'ausilio di sostegni meccanici, contribuisce a creare una luce diffusa nell'ambiente.

MINIMALISM AND SIMPLICITY.

Geometry and light, elegance and simplicity: Bild is a totally disappearing indoor recessed luminaire made of Coral®, installable on plasterboard or brick ceilings, whose linearity becomes the starting point to create unique solutions, where the light beam becomes the absolute protagonist of indoor spaces. The lack of screws or ring nuts in the body of this product allows an extraordinary total disappearance: the luminaire becomes an integral part of the surfaces it is installed on. The satin and recessed glass, laid without the aid of mechanical supports, contributes to creating a scattered light.

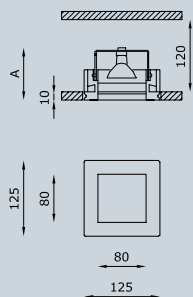

TECHNICAL FEATURES

Code	4423.Z.00	4424.00	4422.00
Type	Downlight 90° 	Downlight 90° 	Downlight 90° 
Material	00: Coral®	00: Coral®	00: Coral®
Weight	1.05 Kg	0.9 Kg	0.95 Kg
Mounting	Ceiling recessed	Ceiling recessed	Ceiling recessed
IP rating	IP40	IP40	IP40
Insulation class	III	III	I
Control gear	Constant current electronic driver (not included)	Electronic transformer (not included)	-
Dimensions	A: 100 mm	A: 90 mm	A: 100 mm
Cut out for plasterboard	135 x 135 mm	135 x 135 mm	135 x 135 mm
Lamp type	LED 500 mA  Vf: 18 VDC	QR CB 51 	QPAR 16 
Lamp wattage	1 x 9W	1 x 50W max	1 x 50W max
Luminous efficacy	1125 lm - 3000K	-	-
Light distribution	Wide beam 40°	-	-
Fitting	-	GU5.3	GU10
Light colour	White 3000K White 2700K 4000K (on request)	-	-
Light hole	80 x 80 mm	80 x 80 mm	80 x 80 mm
Voltage connection	By driver (optional)	By driver (optional)	220-240V · 50/60Hz
CRI	>90	-	-
Emergency	-	-	-
Energy efficiency class	A++	A++	A++
Note	Extra white satin glass. Frosted glass recessed 10 mm into the ceiling. On request available dimmable PUSH or DALI.	Extra white satin glass. Frosted glass recessed 10 mm into the ceiling.	Extra white satin glass. Frosted glass recessed 10 mm into the ceiling.

OPTIONAL ACCESSORIES

product code	optional code	description	info
4423.Z.00	H8500.E	Constant current electronic driver	Suitable for n°2 code 4423.Z.00 - 500 mA
	H8500.B	Constant current electronic driver	Suitable for n°1 code 4423.Z.00 - 500 mA
	BR4423LT	Brick box	Dimensions L: 195 mm; W: 160 mm; D: 160 mm (instructions on page 502)
4424.00	H8060.LED	Dimmable electronic transformer	Max watt 60W Volts · Hz 230/12V · 50/60Hz
	0008KIT	Kit LED dimmable	Bulb 7W · 12V
	BR4424LT	Brick box	Dimensions L: 195 mm; W: 160 mm; D: 160 mm (instructions on page 502)
4422.00	0009KIT	Kit LED dimmable	Bulb 6W · 220-240V
	BR4422LT	Brick box	Dimensions L: 195 mm; W: 160 mm; D: 160 mm (instructions on page 502)



Restaurant - Varazze



Private villa - Olbia

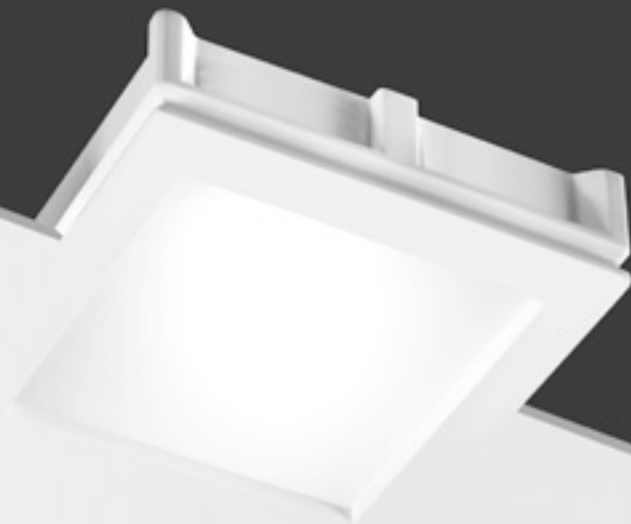

MAXI BILD



MINIMALISMO E POTENZA LUMINOSA.

Il design lineare di Maxi Bild, che si integra nello spazio, crea una luce decisa e delicata che esalta la purezza delle forme. Incasso a scomparsa totale da interni in Coral® per installazione a soffitto di cartongesso o laterizio.

Sintesi di efficienza ed eleganza, Maxi Bild consente infinite soluzioni progettuali: un inserto perfetto per comporre mosaici di luce ricchi di fascino. La presenza del vetro satinato, in appoggio, contribuisce a creare una luce nitida e diffusa nell'ambiente.

MINIMALISM AND LIGHT POWER.

Maxi Bild's linear design, that blends with the environment, creates a decisive and delicate light that exalts the purity of shapes. A totally disappearing indoor recessed luminaire made of Coral®, installable on plasterboard or brick ceilings.

A combination of efficiency and elegance, Maxi Bild allows infinite project solutions: it is the perfect insert for creating light mosaics full of fascination. The satin glass, laid in support, emanates a neat and scattered light within the environmental setting.

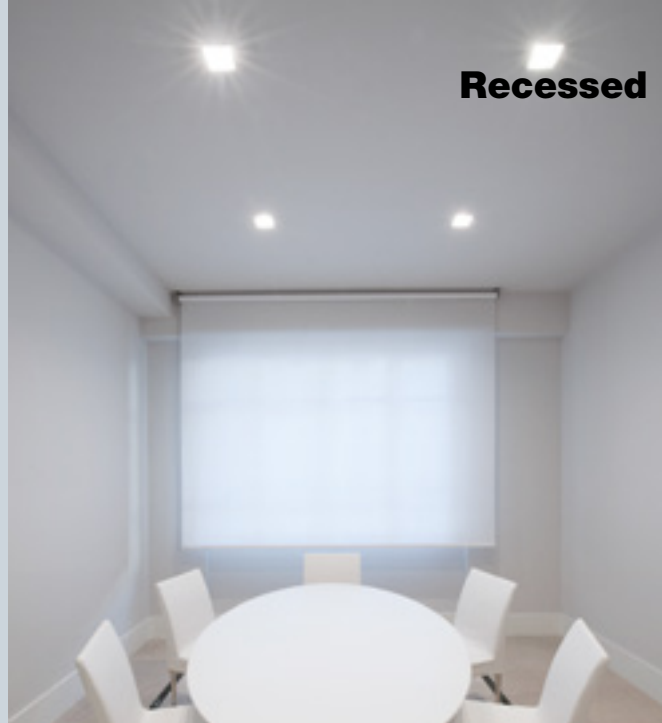
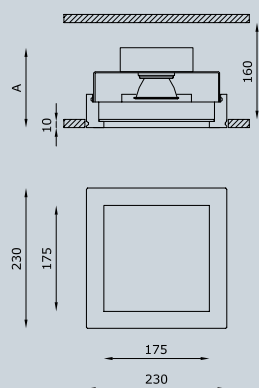

TECHNICAL FEATURES

Code	4411.00	4416.00	4417.00
Type	Downlight 90° 	Downlight 90° 	Downlight 90° 
Material	00: Coral®	00: Coral®	00: Coral®
Weight	3 Kg	3 Kg	3 Kg
Mounting	Ceiling recessed	Ceiling recessed	Ceiling recessed
IP rating	IP40	IP40	IP40
Insulation class	I	I	I
Control gear	Constant current electronic driver	Electronic ballast	Electronic ballast
Dimensions	A: 135 mm	A: 120 mm	A: 120 mm
Cut out for plasterboard	240 x 240 mm	240 x 240 mm	240 x 240 mm
Lamp type	LED 700 mA 	TC-TEL 	TC-TEL 
Lamp wattage	1 x 27W	2 x 26/32W	2 x 26W
Luminous efficacy	102 lm/W - 3000K	-	-
Light distribution	Wide beam 40°	-	-
Fitting	-	Gx24q-3	Gx24q-3
Light colour	White 3000K White 2700K I 4000K (on request)	-	-
Light hole	175x175 mm	175x175 mm	175x175 mm
Voltage connection	220-240V · 50/60Hz	220-240V · 50/60Hz	220-240V · 50/60Hz
CRI	>90	-	-
Emergency	-	-	1 hour
Energy efficiency class	A++	A	A
Note	Extra white satin glass. Frosted glass recessed 10 mm into the ceiling.	Extra white satin glass. Frosted glass recessed 10 mm into the ceiling.	Extra white satin glass. Frosted glass recessed 10 mm into the ceiling.

OPTIONAL ACCESSORIES

product code	optional code	description	info
4416.00	BR4416LT	Brick box	Dimensions L: 445 mm; W: 250 mm; D: 180 mm (instructions on page 502)



RIM



MINIMALISMO E SEMPLICITÀ.

Lo spazio e la luce si fondono, composti dalla stessa sostanza, grazie a Rim, apparecchio da interni a scomparsa totale in Coral® per installazione a soffitto di cartongesso o laterizio.

La luce del Rim, diffusa uniformemente grazie al vetro satinato, interpreta il ruolo di protagonista assoluta avvolgendo lo spazio.

MINIMALISM AND SIMPLICITY.

Space and light become the same substance by Rim, an indoor totally disappearing recessed luminaire made of Coral®, installable on plasterboard or brick ceilings. Rim's light, uniformly scattered within the spaces thanks to the presence of satin glass, features as the main protagonist of the environment it softly embraces.

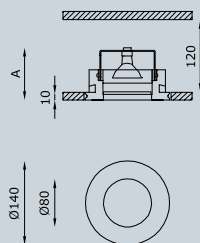

TECHNICAL FEATURES

Code	4433.Z.00	4434.00	4432.00
Type	Downlight 90° 	Downlight 90° 	Downlight 90° 
Material	00: Coral®	00: Coral®	00: Coral®
Weight	0.8 Kg	0.65 Kg	0.7 Kg
Mounting	Ceiling recessed	Ceiling recessed	Ceiling recessed
IP rating	IP40	IP40	IP40
Insulation class	III	III	I
Control gear	Constant current electronic driver (not included)	Electronic transformer (not included)	-
Dimensions	A: 100 mm	A: 90 mm	A: 100 mm
Cut out for plasterboard	Ø 150 mm	Ø 150 mm	Ø 150 mm
Lamp type	LED 500 mA  Vf: 18 VDC	QR CB 51 	QPAR 16 
Lamp wattage	1 x 9W	1 x 50W max	1 x 50W max
Luminous efficacy	1125 lm - 3000K	-	-
Light distribution	Wide beam 40°	-	-
Fitting	-	GU5.3	GU10
Light colour	White 3000K White 2700K 4000K (on request)	-	-
Light hole	Ø 80 mm	Ø 80 mm	Ø 80 mm
Voltage connection	By driver (optional)	By driver (optional)	220-240V · 50/60Hz
CRI	>90	-	-
Emergency	-	-	-
Energy efficiency class	A++	A	A
Note	Extra white satin glass. Frosted glass recessed 10 mm into the ceiling. On request available dimmable PUSH or DALI.	Extra white satin glass. Frosted glass recessed 10 mm into the ceiling.	Extra white satin glass. Frosted glass recessed 10 mm into the ceiling.

OPTIONAL ACCESSORIES

product code	optional code	description	info
4433.Z.00	H8500.E	Constant current electronic driver	Suitable for n°2 code 4433.Z.00 - 500 mA
	H8500.B	Constant current electronic driver	Suitable for n°1 code 4433.Z.00 - 500 mA
	BR4433LT	Brick box	Dimensions L: 195 mm; W: 160 mm; D: 160 mm (instructions on page 502)
4434.00	H8060.LED	Dimmable electronic transformer	Max watt 60W Volts · Hz 230/12V · 50/60Hz
	0008KIT	Kit LED dimmable	Bulb 7W · 12V
	BR4434LT	Brick box	Dimensions L: 195 mm; W: 160 mm; D: 160 mm (instructions on page 502)
4432.00	0009KIT	Kit LED dimmable	Bulb 6W · 220-240V
	BR4432LT	Brick box	Dimensions L: 195 mm; W: 160 mm; D: 160 mm (instructions on page 502)



MAXI RIM



MINIMALISMO E POTENZA LUMINOSA.

La purezza e la perfezione della luce trovano perfetta rappresentazione in Maxi Rim, apparecchio da interni a scomparsa totale in Coral® per l'installazione a soffitto di cartongesso o laterizio, la cui forma circolare si integra negli ambienti con eleganza. Un cerchio luminoso caratterizzato da un vetro satinato che genera un fascio di luce netto e concreto, come un faro che guida alla scoperta dello spazio costruito, delicato e allo stesso tempo deciso, dando vita a scenografie ogni volta diverse.

MINIMALISM AND LIGHT POWER.

The purity and perfection of light are perfectly represented by Maxi Rim, a totally disappearing indoor recessed luminaire, made of Coral® and installable on plasterboard or brick ceilings. It has a circular shape which elegantly integrates itself with the surrounding spaces. A bright sphere in satin glass which creates a neat and concrete beam, like a headlight guiding to the discovery of architectonic spaces, in a delicate yet sharp manner, giving life to ever new light settings.

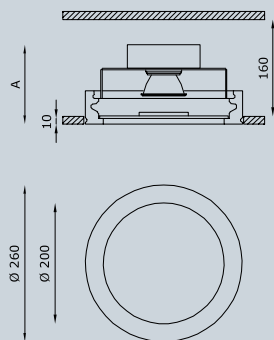

TECHNICAL FEATURES

Code	4441.00	4446.00	4447.00
Type	Downlight 90° 	Downlight 90° 	Downlight 90° 
Material	00: Coral®	00: Coral®	00: Coral®
Weight	2.1 Kg	3.1 Kg	3.3 Kg
Mounting	Ceiling recessed	Ceiling recessed	Ceiling recessed
IP rating	IP40	IP40	IP40
Insulation class	I	I	I
Control gear	Constant current electronic driver	Electronic ballast	Electronic ballast
Dimensions	A: 135 mm	A: 120 mm	A: 120 mm
Cut out for plasterboard	Ø 270 mm	Ø 270 mm	Ø 270 mm
Lamp type	LED 700 mA 	TC-TEL 	TC-TEL 
Lamp wattage	1 x 27W	2 x 26/32W	2 x 26W
Luminous efficacy	102 lm/W - 3000K	-	-
Light distribution	Wide beam 40°	-	-
Fitting	-	Gx24q-3	Gx24q-3
Light colour	White 3000K White 2700K 4000K (on request)	-	-
Light hole	Ø 200 mm	Ø 200 mm	Ø 200 mm
Voltage connection	220-240V · 50/60Hz	220-240V · 50/60Hz	220-240V · 50/60Hz
CRI	>90	-	-
Emergency	-	-	1 hour
Energy efficiency class	A++	A	A
Note	Extra white satin glass. Frosted glass recessed 10 mm into the ceiling.	Extra white satin glass. Frosted glass recessed 10 mm into the ceiling.	Extra white satin glass. Frosted glass recessed 10 mm into the ceiling.

OPTIONAL ACCESSORIES

product code	optional code	description	info
4446.00	BR4446LT	Brick box	Dimensions L: 445 mm; W: 270 mm; D: 225 mm (instructions on page 502)



LYS



MINIMALISMO E SEMPLICITÀ.

Nel Lys, apparecchio da interni a scomparsa totale per installazione a soffitto di cartongesso o laterizio, la resistenza del Coral® si unisce alla delicatezza del vetro satinato extra white retrocesso 5 mm. Performance e diffusione per una luce unica, un quadrato perfetto che conferisce rinnovato stile alle superfici.

MINIMALISM AND SIMPLICITY.

In Lys, a totally disappearing indoor recessed luminaire, installable on plasterboard or brick walls and ceilings, Coral®'s strength merges with the extra-white 5mm recessed satin glass delicacy of the covering. Performances and distribution for a unique light, a perfect square that lends an improved style to surfaces.

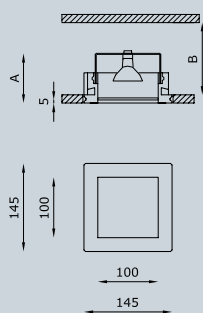

TECHNICAL FEATURES

Code	4426.Z.00	4421.00	4425.00
Type	Downlight 90° 	Downlight 90° 	Downlight 90° 
Material	00: Coral®	00: Coral®	00: Coral®
Weight	0.9 Kg	0.8 Kg	0.85 Kg
Mounting	Ceiling recessed	Ceiling recessed	Ceiling recessed
IP rating	IP40	IP40	IP40
Insulation class	III	III	I
Control gear	Constant current electronic driver (not included)	Electronic transformer (not included)	-
Dimensions	A: 100 mm; B: 130 mm	A: 90 mm; B: 120 mm	A: 100 mm; B: 130 mm
Cut out for plasterboard	155 x 155 mm	155 x 155 mm	155 x 155 mm
Lamp type	LED 500 mA  Vf: 18 VDC	QR CB 51 	QPAR 16 
Lamp wattage	1 x 9W	1 x 50W max	1 x 50W max
Luminous efficacy	1125 lm - 3000K	-	-
Light distribution	Wide beam 40°	-	-
Fitting	-	GU5.3	GU10
Light colour	White 3000K White 2700K 4000K (on request)	-	-
Light hole	100 x 100 mm	100 x 100 mm	100 x 100 mm
Voltage connection	By driver (optional)	By driver (optional)	220-240V · 50/60Hz
CRI	>90	-	-
Emergency	-	-	-
Energy efficiency class	A++	A++	A++
Note	Extra white satin glass. Frosted glass recessed 5 mm into the ceiling. On request available dimmable PUSH or DALI.	Extra white satin glass. Frosted glass recessed 5 mm into the ceiling.	Extra white satin glass. Frosted glass recessed 5 mm into the ceiling.

OPTIONAL ACCESSORIES

product code	optional code	description	info
4426.Z.00	H8500.E	Constant current electronic driver	Suitable for n°2 code 4426.Z.00 - 500 mA
	H8500.B	Constant current electronic driver	Suitable for n°1 code 4426.Z.00 - 500 mA
	BR4426LT	Brick box	Dimensions L: 195 mm; W: 160 mm; D: 160 mm (instructions on page 502)
4421.00	H8060.LED	Dimmable electronic transformer	Max watt 60W Volts · Hz 230/12V · 50/60Hz
	0008KIT	Kit LED dimmable	Bulb 7W · 12V
	BR4421LT	Brick box	Dimensions L: 195 mm; W: 160 mm; D: 160 mm (instructions on page 502)
4425.00	0009KIT	Kit LED dimmable	Bulb 6W · 220-240V
	BR4425LT	Brick box	Dimensions L: 195 mm; W: 160 mm; D: 160 mm (instructions on page 502)



Armani Casa - Maçka Residences - ph. E. Abrate - Istanbul



Armani Casa - Maçka Residences - Istanbul



NOVA



INCASSO A SCOMPARSA DAI BORDI STONDATI.

Un incasso a scomparsa totale da interni in AirCoral® per installazione in soffitto di cartongesso caratterizzato da un foro luce stonato in grado di donare grande plasticità al soffitto. Il fascio luminoso creato da Nova accentua l'effetto di morbidezza delle superfici su cui è installato e degli ambienti.

TOTALLY RECESSED FITTING WITH ROUNDED EDGES.

This indoor recessed lighting system made of AirCoral® has a rounded light hole and a total disappearance effect into plasterboard ceilings able to give great plasticity to the ceiling. The light created by Nova emphasizes the smooth effect given by the surfaces it is installed on.

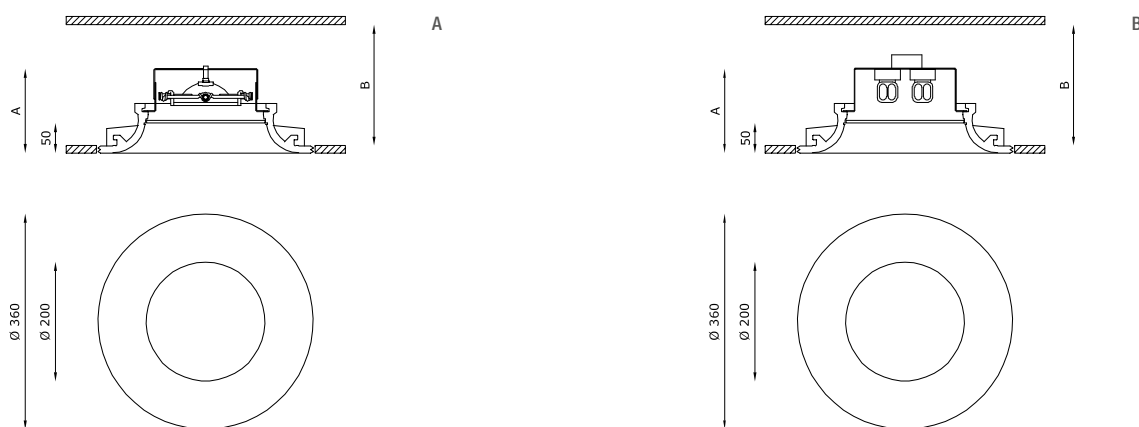

TECHNICAL FEATURES

Code	5271.AC (fig. A)	5276.AC (fig. B)	5285.AC (fig. B)	5291.AC (fig. B)	5293.AC (fig. B)
Type	Tilttable downlight $\pm 30^\circ$ 	Downlight 90° 	Downlight 90° 	Downlight 90° 	Downlight 90°
Material	AC: AirCoral®	AC: AirCoral®	AC: AirCoral®	AC: AirCoral®	AC: AirCoral®
Absorption capacity*	8.92 m ²	8.92 m ²	8.92 m ²	8.92 m ²	8.92 m ²
Weight	5.5 Kg	5.6 Kg	5.8 Kg	6.8 Kg	5.8 Kg
Mounting	Ceiling recessed	Ceiling recessed	Ceiling recessed	Ceiling recessed	Ceiling recessed
IP rating	IP40	IP40	IP40	IP40	IP40
Insulation class	III	I	I	I	I
Control gear	Dimmable electronic transformer	Electronic ballast	Electronic ballast	Constant current electronic driver	Dimmable constant current driver
Dimensions	A: 165 mm; B: 250 mm	A: 165 mm; B: 250 mm	A: 180 mm; B: 250 mm	A: 200 mm; B: 220 mm	A: 170 mm; B: 220 mm
Cut out for plasterboard	\varnothing 370 mm	\varnothing 370 mm	\varnothing 370 mm	\varnothing 370 mm	\varnothing 370 mm
Lamp type	QR 111 	TC-TEL 	TC-TEL 	LED 1050 mA 	LED 350 mA
Lamp wattage	1 x 100W max	2 x 26/32W	2 x 26W	1 x 40W	2 x 6.5W
Luminous efficacy	-	-	-	4680 lm - 3000K	2 x 810 lm - 3000K
Light distribution	-	-	-	Wide beam 40°	Wide beam 120°
Fitting	G53	Gx24q-3	Gx24q-3	-	-
Light colour	-	-	-	White 3000K White 2700K 4000K (on request)	White 3000K White 2700K 4000K (on request)
Light hole	\varnothing 200 mm	\varnothing 200 mm	\varnothing 200 mm	\varnothing 200 mm	\varnothing 200 mm
Voltage connection	220-240V / 12V · 50/60Hz	220-240V · 50/60Hz	220-240V · 50/60Hz	220-240V · 50/60Hz	220-240V · 50/60Hz
CRI	-	-	-	>90	>90
Emergency	-	-	1 hour	-	-
Energy efficiency class	A	A+	A+	A++	A+
Note	Extra white satin glass. Frosted glass recessed 50 mm into the ceiling.	Extra white satin glass. Frosted glass recessed 50 mm into the ceiling.	Extra white satin glass. Frosted glass recessed 50 mm into the ceiling.	Extra white satin glass. Frosted glass recessed 50 mm into the ceiling.	Extra white satin glass. Frosted glass recessed 50 mm into the ceiling. Trailing-edge and leading-edge dimming (20 - 100%).

OPTIONAL ACCESSORIES

product code	optional code	description	info
5271.AC	00010KIT	Kit LED dimmable	Bulb 10W · 12V

* The absorption capacity per m² calculated by the American organization TCNA (Tile Council of North America) is measured for an average room of 2,7 m in height and therefore expressed in m²



Bar I Mulini - ph- G. Doppiu - Cagliari





SUPERNOVA



UNA LAMPADA DA INCASSO
MA ANCHE UNA BOTOLA DI ISPEZIONE.

Un'esplosione luminosa, un dettaglio di luce che all'improvviso si staglia nell'ambiente conferendo un effetto di morbidezza delle superfici, illuminandolo in modo deciso. Supernova è un apparecchio da interni a scomparsa totale con corpo in AirCoral® a luce diretta per installazione in soffitto di cartongesso che dona vita ai particolari costruttivi.







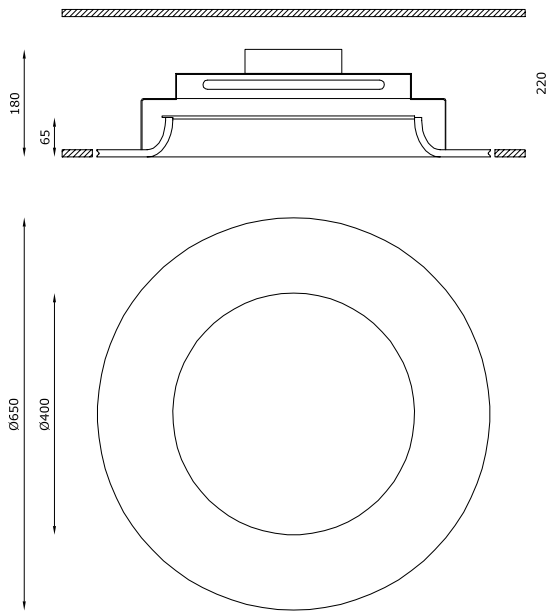

Il foro luce stondato esalta la plasticità dei soffitti, rispondendo alle esigenze architettoniche contemporanee. La parte elettrica di Supernova può essere sollevata e **utilizzata come botola di accesso per l'ispezione** del controsoffitto.

*A LIGHT WITH RECESSED FITTING
BUT ALSO AN INSPECTION HATCH.*

*A bright explosion, a detail of light that suddenly stands out in the spaces, illuminating in a decisive way. Supernova is a totally disappearing direct light recessed indoor luminaire made of AirCoral®, installable on plasterboard ceilings, perfect to enlighten architectural details. The rounded light hole creates a decisive light to enhance the plasticity of the ceiling, satisfying the contemporary architectural requests. The electric part of Supernova can be lifted from the support and **be used as trapdoor for the inspection** of the false ceiling.*



TECHNICAL FEATURES

Code	5134.AC	5133.AC	5135.AC
Type	Downlight 90° 	Downlight 90° 	Downlight 90° 
Material	AC: AirCoral®	AC: AirCoral®	AC: AirCoral®
Absorption capacity*	21.04 m ²	21.04 m ²	21.04 m ²
Weight	9.4 Kg	9 Kg	9 Kg
Mounting	Ceiling recessed	Ceiling recessed	Ceiling recessed
IP rating	IP40	IP40	IP40
Insulation class	I	III	III
Control gear	Electronic ballast	Constant current electronic driver	Constant current electronic driver
Cut out for plasterboard	Ø 660 mm	Ø 660 mm	Ø 660 mm
Lamp type	TR5 	LED 700 mA 	LED 1050 mA 
Lamp wattage	1 x 55W	1 x 20W	1 x 30W
Luminous efficacy	-	2750 lm	3950 lm
Light distribution	-	Wide beam 120°	Wide beam 120°
Fitting	2Gx13	-	-
Light colour	-	White 3000K White 4000K (on request)	White 3000K White 4000K (on request)
Light hole	Ø 400 mm	Ø 400 mm	Ø 400 mm
Voltage connection	220-240V · 50/60Hz	220-240V · 50/60Hz	220-240V · 50/60Hz
CRI	-	>90	>90
Emergency	-	-	-
Energy efficiency class	A	A+	A+
Note	Can be used as a trap door for inspecting the false ceiling. 	Can be used as a trap door for inspecting the false ceiling. 	Can be used as a trap door for inspecting the false ceiling. 

* The absorption capacity per m² calculated by the American organization TCNA (Tile Council of North America) is measured for an average room of 2,7 m in height and therefore expressed in m²







POLARIS



UNA CUPOLA DI LUCE
MA ANCHE UNA BOTOLA DI ISPEZIONE.







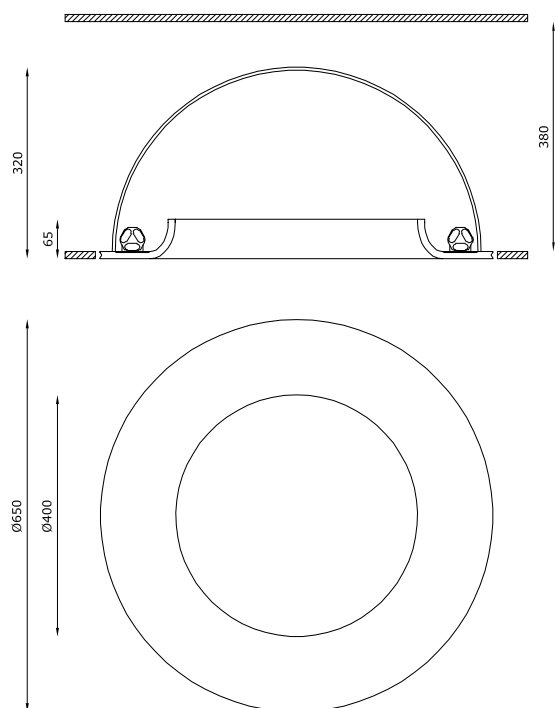





Incasto a scomparsa totale da interni in AirCoral® a luce indiretta per installazione in soffitto di cartongesso, Polaris è dotato di una cupola realizzata in un materiale composito alleggerito, in grado di riflettere la luce emessa dalla sorgente luminosa nascosta e diffonderla in modo indiretto nello spazio. Non è semplicemente un apparecchio illuminante ma anche un prezioso elemento che parla la lingua della funzionalità. La cupola del Polaris, infatti, può essere sollevata e **utilizzata come botola di accesso per l'ispezione** del controsoffitto.

A DOME OF LIGHT
BUT ALSO AN INSPECTION HATCH.

*Polaris is a totally disappearing direct light recessed indoor luminaire made of AirCoral®, installable on plasterboard ceilings. It has a bright cupola made out of a composite unloaded material capable of reflecting the source light and spread it out indirectly in the room. Not just a light source but also a precious furniture item, that speaks the language of functionality. As a matter of fact, Polaris can be lifted from the support and **be used as trapdoor for the inspection** of the false ceiling.*



TECHNICAL FEATURES

Code	6977.AC	6974.AC	6978.AC	6975.PAC
Type	Downlight 90° 	Downlight 90° 	Downlight 90° 	Downlight 90° 
Material	AC: AirCoral®	AC: AirCoral®	AC: AirCoral®	AC: AirCoral®
Absorption capacity*	21.04 m ²	21.04 m ²	21.04 m ²	21.04 m ²
Weight	10.2 Kg	10.6 Kg	10 Kg	10.2 Kg
Mounting	Ceiling recessed	Ceiling recessed	Ceiling recessed	Ceiling recessed
IP rating	IP20	IP20	IP20	IP20
Insulation class	I	I	III	I
Control gear	Electronic ballast	Electronic ballast	Constant voltage driver	Dimmable electronic ballast
Cut out for plasterboard	Ø 660 mm	Ø 660 mm	Ø 660 mm	Ø 660 mm
Lamp type	TC-TEL 	TC-TEL 	LED 12V 	TC-TEL 
Lamp wattage	4 x 42W	4 x 26/32W	1 x 24W	4 x 26/32W
Luminous efficacy	-	-	1800 lm	-
Light distribution	-	-	Wide beam 120°	-
Fitting	Gx24q-4	Gx24q-3	-	Gx24q-3
Light colour	-	-	White 3000K	-
Light hole	Ø 400 mm	Ø 400 mm	Ø 400 mm	Ø 400 mm
Voltage connection	220-240V · 50/60Hz	220-240V · 50/60Hz	220-240V / 12V · 50/60Hz	220-240V · 50/60Hz
CRI	-	-	>90	-
Emergency	-	1 hour	-	-
Energy efficiency class	A	A	A+	A
Note	Can be used as a trap door for inspecting the false ceiling. 	Can be used as a trap door for inspecting the false ceiling. 	Can be used as a trap door for inspecting the false ceiling. 	Can be used as a trap door for inspecting the false ceiling. 
				Standard: dimmable switch dim. / push (on request: dimmable 1-10V or DALI).

* The absorption capacity per m² calculated by the American organization TCNA (Tile Council of North America) is measured for an average room of 2,7 m in height and therefore expressed in m²





Design

Mammini+Candido



ARGIA



LA VALORIZZAZIONE DELLA "LAMPADINA".

Apparecchio illuminante in AirCoral® pensato in sottrazione di materia, per installazione in parete e soffitto di cartongesso o laterizio. Plasticità e versatilità sono le sue caratteristiche principali: due le versioni disponibili, per adattarsi a tutte le esigenze illuminotecniche. Argia crea una luce morbida e accogliente che ha un preciso obiettivo: avvolgere gli ambienti, in modo discreto in un delicato gioco di luci e ombre.

VALORISATION OF THE "BULB".

A lighting fixture made of AirCoral® thought without material, installable on plasterboard or brick walls and ceilings. Plasticity and versatility are the main features: two versions available, to adapt to every lighting design need. Argia creates a warm and welcoming light with a specific goal: to wrap spaces up, in a discreet and noninvasive way in a delicate play of lights and shadows.

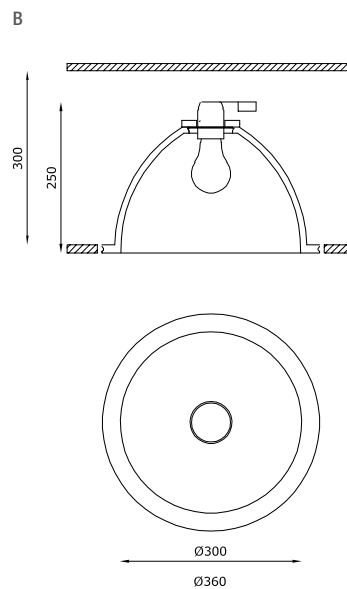
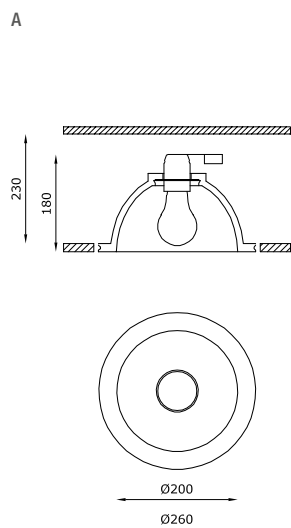

TECHNICAL FEATURES

Code	6921.AC (fig A)	6931.AC (fig B)
Type	Downlight 90° Wall recessed 90° 	Downlight 90° Wall recessed 90°
Material	AC: AirCoral®	AC: AirCoral®
Absorption capacity*	7.75 m ²	14.86 m ²
Weight	2.5 Kg	3.5 Kg
Mounting	Wall and ceiling recessed	Wall and ceiling recessed
IP rating	IP20	IP20
Insulation class	I	I
Control gear	-	-
Cut out for plasterboard	Ø 270 mm	Ø 370 mm
Lamp type	A 60 	A 60
Lamp wattage	1 x 100W max	1 x 100W max
Luminous efficacy	-	-
Light distribution	-	-
Fitting	E27	E27
Light colour	-	-
Light hole	Ø 200 mm	Ø 300 mm
Voltage connection	220-240V · 50/60Hz	220-240V · 50/60Hz
CRI	-	-
Emergency	-	-
Energy efficiency class	A	A
Note	Fits to LED bulb with E27 socket.	Fits to LED bulb with E27 socket.

* The absorption capacity per m² calculated by the American organization TCNA (Tile Council of North America) is measured for an average room of 2.7 m in height and therefore expressed in m²



Private villa - Austria



Design

Mammini+Candido

LENTIL



UN SEGNAPASSO DAL MINIMO INGOMBRO.

Indicare percorsi, creare composizioni, accentuare dettagli: Lentil è incasso a scomparsa totale in AirCoral® per installazione in parete e soffitto di cartongesso o laterizio che definisce gli spazi suggerendo emozioni precise e delicate. Un segnapasso dallo stile unico nella sua essenzialità, con parabola wall-washer che sfuma la luce, per un delicato risultato finale che risponde alle esigenze di progettisti e committenti.

A PATH LIGHTER WITH MINIMUM DIMENSIONS.

Pointing out paths, creating compositions, highlighting details: Lentil is a totally disappearing indoor recessed luminaire made of AirCoral®, installable on plasterboard or brick walls and ceilings that defines architectures suggesting precise and delicate emotions. A walkway source of lighting, with a unique style in its simplicity and a wall-washer parabola which blends light for a delicate result that answers the needs of designers and customers.



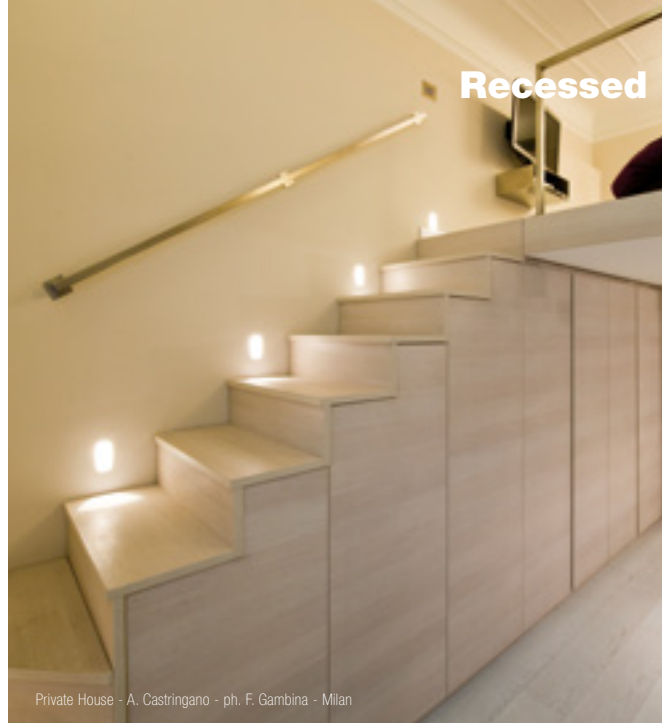
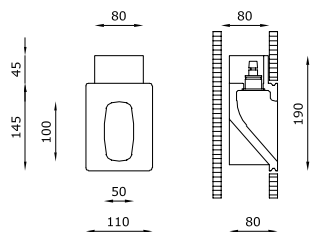

Private House - A. Castrignano - ph. F. Gambina - Milan

TECHNICAL FEATURES

Code	6358.AC
Type	Wall-washer
Material	AC: AirCoral®
Absorption capacity*	2.29 m ²
Weight	1 Kg
Mounting	Wall and ceiling recessed
IP rating	IP40
Insulation class	III
Control gear	Constant current electronic driver (not included)
Cut out for plasterboard	120 x 155 mm
Lamp type	LED ⚡ Vf: 3 VDC
Lamp wattage	1W - 350 mA 2W - 500 mA
Luminous efficacy	75 lm - 3000K 350 mA 170 lm - 3000K 500 mA
Light distribution	Wide beam 120°
Fitting	-
Light colour	White 3000K White 2700K (on request)
Light hole	50 x 100 mm
Voltage connection	By driver (optional)
CRI	>90
Emergency	-
Energy efficiency class	A++
Note	On request available dimmable PUSH or DALI, remote installation.

OPTIONAL ACCESSORIES

<i>product code</i>	<i>optional code</i>	<i>description</i>	<i>info</i>
6358.AC	H8350	Constant current electronic driver	Suitable for n°1 code 6358.AC - 350 mA
	H8500.B	Constant current electronic driver. Remote installation	Suitable for n°5 code 6358.AC - 500 mA
	H8500.C	Constant current electronic driver. Remote installation	Suitable for n°2 code 6358.AC - 500 mA
	BR6358LT	Brick box	Dimensions L: 260 mm; W: 120 mm; D: 100 mm (<i>instructions on page 502</i>)

* The absorption capacity per m² calculated by the American organization TCNA (Tile Council of North America) is measured for an average room of 2.7 m in height and therefore expressed in m²

Design

Mammini+Candido

BLADE



SISTEMA MODULARE E TAGLIABILE A MISURA.

Blade è un sistema modulare da interni a scomparsa totale in AirCoral® per l'installazione a parete e soffitto di cartongesso o laterizio. Una lama di luce che fende il buio, che segna i percorsi, che determina gli spazi interni. Blade può essere utilizzato a moduli multipli con una o due sorgenti luminose contrapposte che illuminano il corpo interno.

Integrato nella parete o nel soffitto, crea scenografie luminose dal fascino unico e suggestivo.

MODULAR SYSTEM WHICH CAN BE CUT TO MEASURE.

Blade is a totally disappearing indoor recessed luminaire made of AirCoral®, installable on plasterboard or brick walls and ceilings. A blade of light that can be used in multiple ways, creating actual bright cuts inside walls. Blade can be installed with one or two counterposed light sources that illuminate the body. Integrate inside walls or ceilings, it highlights paths and defines spaces.



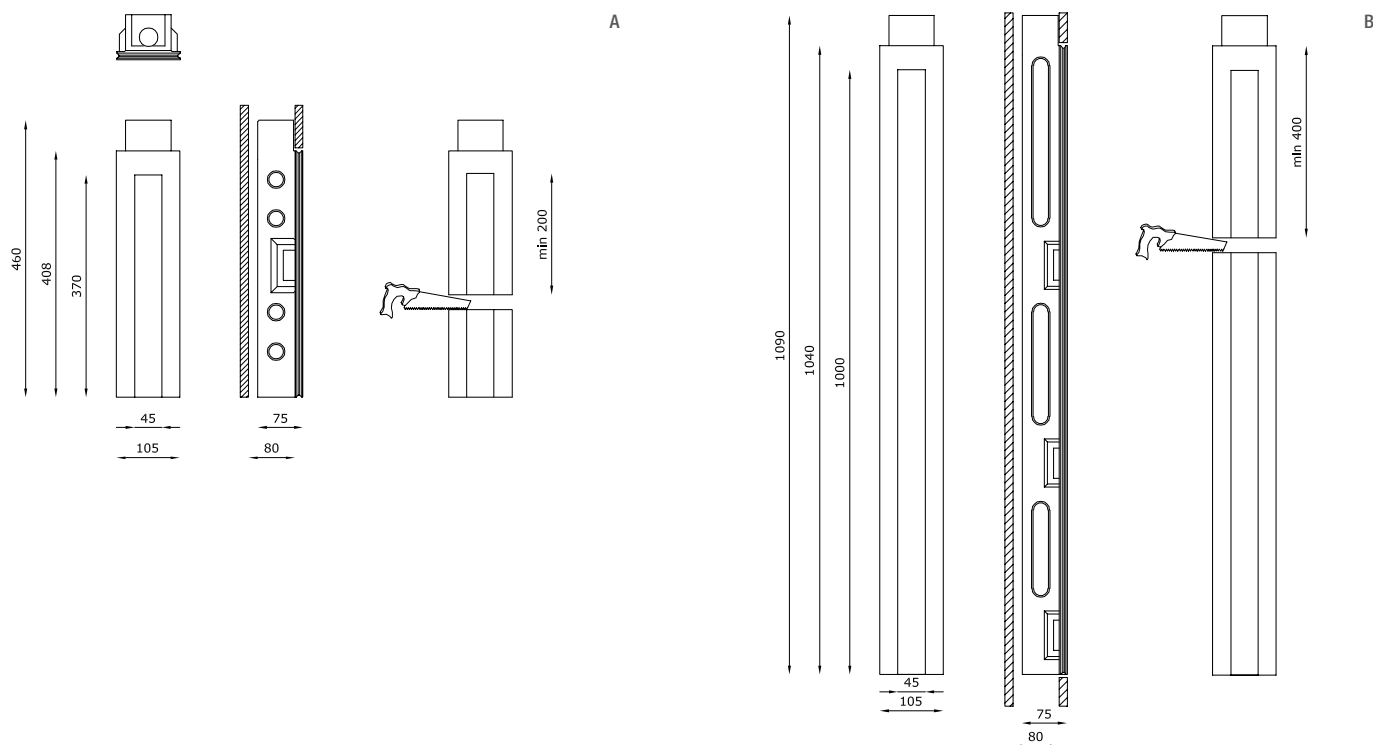

TECHNICAL FEATURES | ELECTRIFIED BODY

Code	6968.AC (fig. A)	6967.AC (fig. B)
Type	Downlight 90° Wall recessed 90° ▲▲▲	Downlight 90° Wall recessed 90° ▲▲▲
Material	AC: AirCoral®	AC: AirCoral®
Absorption capacity*	8.14 m ²	19.28 m ²
Weight	2.8 Kg	6.2 Kg
Mounting	Wall and ceiling recessed	Wall and ceiling recessed
IP rating	IP40	IP40
Insulation class	III	III
Control gear	-	-
Cut out for plasterboard	415 x 115 mm	1050 x 115 mm
Lamp type	LED ☑ Vf: 3 VDC	LED ☑ Vf: 3 VDC
Lamp wattage	1W - 350 mA 2W - 500 mA	1W - 350 mA 2W - 500 mA
Luminous efficacy	75 lm - 3000K 350 mA 170 lm - 3000K 500 mA	75 lm - 3000K 350 mA 170 lm - 3000K 500 mA
Light distribution	Narrow beam 14°	Narrow beam 14°
Fitting	-	-
Light colour	White 3000K White 2700K (on request)	White 3000K White 2700K (on request)
Light hole	370 x 45 mm	370 x 45 mm
Voltage connection	By driver (optional)	By driver (optional)
CRI	>90	>90
Emergency	-	-
Energy efficiency class	A++	A++
Note	It is possible to cut the electrified body to obtain a light hole 200 mm minimum. On request available dimmable PUSH or DALI, remote installation. This product could be ordered with IP44 / IP65 protection grade (see OUTDOOR section - code 6965.CW / 6987.CW).	It is possible to cut the electrified body to obtain a light hole 400 mm minimum. On request available dimmable PUSH or DALI, remote installation. This product could be ordered with IP44 / IP65 protection grade (see OUTDOOR section - code 6966.CW / 6988.CW).

Optional accessories on page 234

* The absorption capacity per m² calculated by the American organization TCNA (Tile Council of North America) is measured for an average room of 2.7 m in height and therefore expressed in m²

OPTIONAL ACCESSORIES

product code	optional code	description	info
6968.AC	H8350	Constant current electronic driver	Suitable for n°1 code 6968.AC - 350 mA
	H8500.B	Constant current electronic driver. Remote installation	Suitable for n°5 code 6968.AC - 500 mA
	H8500.C	Constant current electronic driver. Remote installation	Suitable for n°2 code 6968.AC - 500 mA
	BR6968LT	Brick box	Dimensions L: 490 mm; W: 110 mm; D: 85 mm <i>(instructions on page 502)</i>
6967.AC	H8350	Constant current electronic driver	Suitable for n°1 code 6967.AC - 350 mA
	H8500.B	Constant current electronic driver. Remote installation	Suitable for n°5 code 6967.AC - 500 mA
	H8500.C	Constant current electronic driver. Remote installation	Suitable for n°2 code 6967.AC - 500 mA
	BR6967LT	Brick box	Dimensions L: 1120 mm; W: 110 mm; D: 85 mm <i>(instructions on page 502)</i>

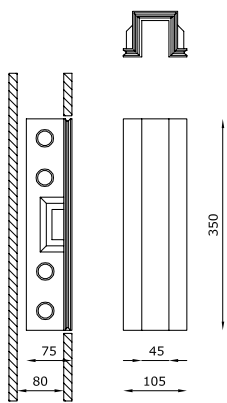

C

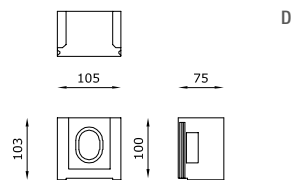

D

TECHNICAL FEATURES | MODULAR BODY

Code	6961.AC (fig. C)
Material	AC: AirCoral®
Absorption capacity*	6.47 m ²
Weight	2 Kg
IP rating	-
Cut out for plasterboard	(350 mm for each module installed) x 115 mm
Light hole	(350 mm for each module installed) x 45 mm
Note	This product could be ordered with IP44 / IP65 protection grade (see OUTDOOR section - code 6964.CW).

TECHNICAL FEATURES | CLOSURE HEADPARTS

Code	6962.AC (fig. D)
Material	AC: AirCoral®
Absorption capacity*	2.59 m ²
Weight	0.7 Kg
IP rating	-
Cut out for plasterboard	115 x 115 mm
Light hole	-
Note	This product could be ordered with IP44 / IP65 protection grade (see OUTDOOR section - code 6963.CW).

Supplied singularly it can be used in alternative to a further electrified body (code 6968.AC / 6967.AC) to close a continuous line of the BLADE product.

EXAMPLES OF INSTALLATION

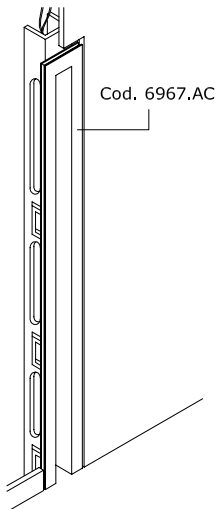
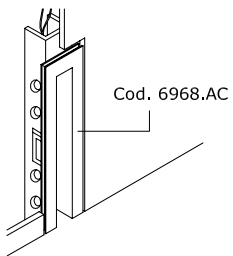

Singular module
No. 1 electrified body

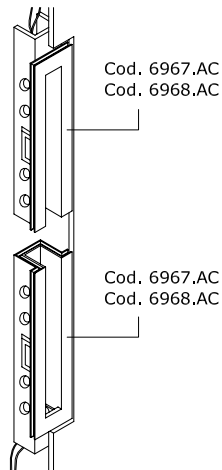

No. 2 electrified bodies
in opposite position

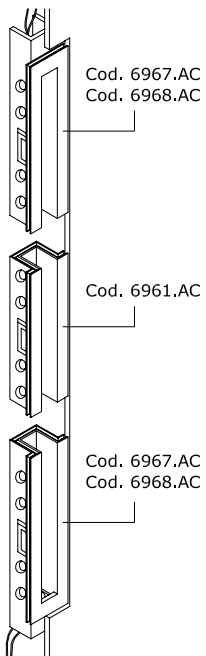

No. 2 electrified bodies
in opposite position
No. 1 modular body in AirCoral®

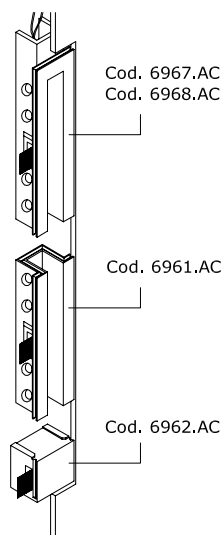

No. 1 electrified body
No. 1 modular body in AirCoral®
No. 1 closure headpart







PHANTOM



INCASSO WALL WASHER DI PICCOLE DIMENSIONI.



Le superfici sono valorizzate da Phantom, un incasso per interni a scomparsa totale in Coral® per l'installazione in parete e soffitto di cartongesso o laterizio caratterizzato da una parabola che crea una luce dall'effetto wall washer. Le linee pulite ed eleganti conferiscono un valore aggiunto alla luce, enfatizzando i percorsi, e rendendo Phantom perfetto per impieghi sia come luce decorativa che d'accento oppure come segnapasso. Un fantasma che ritaglia spiragli luminosi negli ambienti, abbracciando con delicatezza gli arredi e le superfici.

SMALL WALL WASHER RECESSED FITTING.

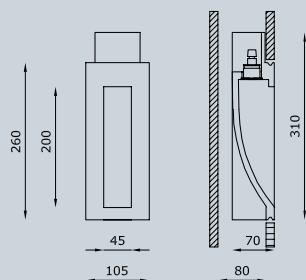
Phantom, an indoor totally disappearing recessed luminaire made of Coral® installable on plasterboard or brick ceilings and walls, is characterized by a parabola that creates a wall washer light effect. Its clean and elegant lines give an added value to the light, and make it perfect to be used as a decoration, to emphasize a place or as a footpath. A ghost that cuts off luminous openings in the ambients, encompassing delicately both furniture and surfaces.



TECHNICAL FEATURES

Code	6488.00
Type	Wall-washer 
Material	00: Coral®
Weight	1.4 Kg
Mounting	Wall and ceiling recessed
IP rating	IP40
Insulation class	III
Control gear	Constant current electronic driver (not included)
Cut out for plasterboard	115 x 270 mm
Lamp type	LED  Vf: 3 VDC
Lamp wattage	1W - 350 mA 2W - 500 mA
Luminous efficacy	75 lm - 3000K 350 mA 170 lm - 3000K 500 mA
Light distribution	Narrow beam 14°
Fitting	-
Light colour	White 3000K White 2700K (on request)
Light hole	45 x 200 mm
Voltage connection	By driver (optional)
CRI	>90
Emergency	-
Energy efficiency class	A++
Note	On request available dimmable PUSH or DALI, remote installation.

OPTIONAL ACCESSORIES

product code	optional code	description	info
6488.00	H8350	Constant current electronic driver	Suitable for n°1 code 6488.00 - 350 mA
	H8500.B	Constant current electronic driver. Remote installation	Suitable for n°5 code 6488.00 - 500 mA
	H8500.C	Constant current electronic driver. Remote installation	Suitable for n°2 code 6488.00 - 500 mA
	BR6488LT	Brick box	Dimensions L: 340 mm; W: 115 mm; D: 80 mm (instructions on page 502)

GHOST



INCASSO WALL WASHER.

Ghost scompare nelle superfici, si integra con la materia, plasma e modella pareti e soffitti: un vero fantasma luminoso che dà vita a scenografie dal design esclusivo, caratterizzato da una parabola wall-washer; sintesi perfetta di efficienza ed eleganza. Discreto e lineare, l'apparecchio per interni a scomparsa totale per installazione in parete e soffitto di cartongesso o laterizio è prodotto con l'esclusivo materiale AirCoral®. Ghost si presenta come una soluzione versatile all'interno del progetto architettonico, potendo adattarsi ad impieghi sia come luce d'accento, sia decorativa e segnapasso.

WALL WASHER RECESSED FITTING.

Ghost disappears inside surfaces, integrating with matter, moulding and shaping spaces and ceilings: a real bright ghost that gives life to sceneries with an exclusive design and a parabola-shaped body that creates a wall-washer light effect; perfect combination of efficiency and elegance.

Discrete and linear, the front body of this totally disappearing indoor recessed luminaire, installable on plasterboard or brick walls and ceilings, is made of AirCoral®. Ghost offers a wide range of solutions for architectonic projects, as it can be used as underlying, decorative or guiding light.



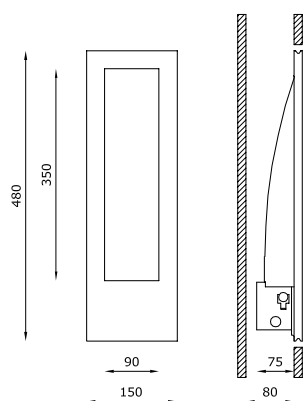

3.5W - 350 mA LED



3.5W - 350 mA LED



3.5W - 350 mA LED

TECHNICAL FEATURES

Code	6333.AC
Type	Wall-washer
Material	AC: AirCoral®
Absorption capacity*	7.83 m ²
Weight	3 Kg
Mounting	Wall and ceiling recessed
IP rating	IP40
Insulation class	III
Control gear	Constant current electronic driver
Cut out for plasterboard	160 x 490 mm
Lamp type	LED 350 mA
Lamp wattage	1 x 3.5W
Luminous efficacy	470 lm - 3000K
Light distribution	Wide beam 120°
Fitting	-
Light colour	White 3000K White 2700K 4000K (on request)
Light hole	90 x 350 mm
Voltage connection	220-240V · 50/60Hz
CRI	>90
Emergency	-
Energy efficiency class	A++
Note	-

OPTIONAL ACCESSORIES

<i>product code</i>	<i>optional code</i>	<i>description</i>	<i>info</i>
6333.AC	BR6333LT	Brick box	Dimensions L: 160 mm; W: 550 mm; D: 85 mm (<i>instructions on page 502</i>)

* The absorption capacity per m³ calculated by the American organization TCNA (Tile Council of North America) is measured for an average room of 2.7 m in height and therefore expressed in m²

Ghost



Private villa - Austria



SPIRIT



INCASSO WALL WASHER.

Luce che arreda, semplicemente con la forza della purezza e del design: Spirit è un apparecchio da interni a scomparsa totale in AirCoral® per installazione in parete e soffitto di cartongesso o laterizio. È un incasso che cambia la percezione degli spazi, costruendo scenografie suggestive, grazie alle sue forme geometriche precise; gli ambienti prendono vita in modo unico attraverso una luce con effetto wall-washer.

WALL WASHER RECESSED FITTING.

A light that decorates, simply by force of purity and design: Spirit is an indoor totally disappearing product made of AirCoral®, installable on plasterboard or brick walls and ceilings. It is a recessed luminaire which changes space perception, building suggestive light sceneries thanks to its precise geometric forms; the environment comes to life through a wall-washer light effect.



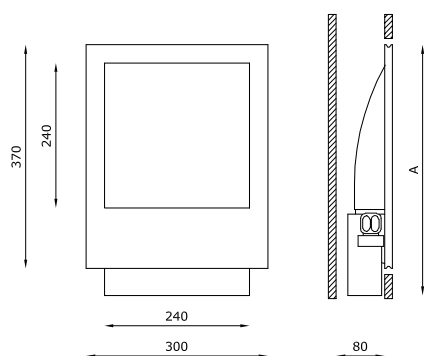

max 60W R7s
max 26/32W Gx24q-3
max 42W Gx24q-4
max 6.5W - 350 mA LED



max 150W R7s
max 26/32W Gx24q-3
max 6.5W - 350 mA LED



max 150W R7s
max 26/32W Gx24q-3
max 42W Gx24q-4
max 6.5W - 350 mA LED

TECHNICAL FEATURES

Code	6252.AC	6264.EB.AC	6258.AC	6259.AC
Type	Wall-washer 	Wall-washer 	Wall-washer 	Wall-washer
Material	AC: AirCoral®	AC: AirCoral®	AC: AirCoral®	AC: AirCoral®
Absorption capacity*	10.86 m ²	10.86 m ²	10.86 m ²	10.86 m ²
Weight	3.3 Kg	3.4 Kg	3.9 Kg	3.5 Kg
Mounting	Wall and ceiling recessed	Wall and ceiling recessed	Wall and ceiling recessed	Wall and ceiling recessed
IP rating	IP40	IP40	IP40	IP40
Insulation class	I	I	I	I
Control gear	-	Electronic ballast	Electronic ballast	Dimmable constant current driver
Dimensions	A: 370 mm	A: 435 mm	A: 520 mm	A: 370 mm
Cut out for plasterboard	310 x 380 mm	310 x 380 mm	310 x 380 mm	310 x 380 mm
Lamp type	QT-DE12 (75 mm) 	TC-DEL/TEL 	TC-DEL/TEL 	LED 350 mA
Lamp wattage	1 x 60W	1 x 26/32W	1 x 26/32W	1 x 6.5W
Luminous efficacy	-	-	-	810 lm - 3000K
Light distribution	-	-	-	Wide beam 120°
Fitting	R7s	Gx24q-3	Gx24q-3	-
Light colour	-	-	-	White 3000K White 2700K 4000K (on request)
Light hole	240 x 240 mm	240 x 240 mm	240 x 240 mm	240 x 240 mm
Voltage connection	220-240V · 50/60Hz	220-240V · 50/60Hz	220-240V · 50/60Hz	220-240V · 50/60Hz
CRI	-	-	-	>90
Emergency	-	-	1 hour	-
Energy efficiency class	A	A	A	A+
Note	-	-	-	Trailing-edge and leading-edge dimming (20 - 100%).

OPTIONAL ACCESSORIES

product code	optional code	description	info
6252.AC	BR6252LT	Brick box	Dimensions L: 455 mm; W: 310 mm; D: 160 mm (instructions on page 502)
6264.EB.AC	BR6264EBLT	Brick box	Dimensions L: 455 mm; W: 310 mm; D: 160 mm (instructions on page 502)
6258.AC	BR6258LT	Brick box	Dimensions L: 540 mm; W: 310 mm; D: 160 mm (instructions on page 502)
6259.AC	BR6259LT	Brick box	Dimensions L: 455 mm; W: 310 mm; D: 160 mm (instructions on page 502)

* The absorption capacity per m² calculated by the American organization TCNA (Tile Council of North America) is measured for an average room of 2.7 m in height and therefore expressed in m²



Private House - A. Castrignano - ph. F. Gambina - Milan



Private house - A. Castrignano - ph. E. Abrate - Milan

GLOBE



INCASSO WALL WASHER.

Elegante, un design circolare che inonda gli ambienti di luce, prestandosi a composizioni originali a parete e soffitto, creando atmosfere delicate e, allo stesso tempo, ricche di stile. Globe è un apparecchio da interni a scomparsa totale per installazione in parete e soffitto di cartongesso o laterizio con corpo realizzato in AirCoral®. Globe crea con la sua parabola wall-washer un cerchio luminoso che ha un preciso obiettivo: attribuire alla luce il ruolo di assoluta protagonista regalando un valore aggiunto ad ogni spazio in cui viene installato.

WALL WASHER RECESSED FITTING.

Elegant, a circular design that floods spaces with suffused lighting, creating delicate and stylish atmospheres. Globe is a totally disappearing indoor recessed luminaire, installable on plasterboard or brick walls and ceilings, with a body made of AirCoral®.

Globe creates with its wall-washer parabola a luminous circle that has a precise aim: giving light the role of absolute protagonist, adding value on any space it is installed in.



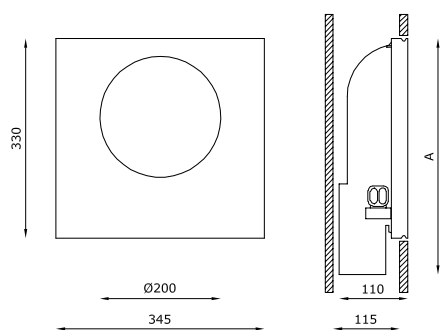

max 60W R7s
max 26/32W Gx24q-3
max 42W Gx24q-4
max 6.5W - 350 mA LED











max 150W R7s
max 26/32W Gx24q-3
max 6.5W - 350 mA LED



max 150W R7s
max 26/32W Gx24q-3
max 42W Gx24q-4
max 6.5W - 350 mA LED

TECHNICAL FEATURES

Code	6292.AC	6294.EB.AC	6298.AC	6289.AC
Type	Wall-washer 	Wall-washer 	Wall-washer 	Wall-washer 
Material	AC: AirCoral®	AC: AirCoral®	AC: AirCoral®	AC: AirCoral®
Absorption capacity*	14.61 m ²	14.61 m ²	14.61 m ²	14.61 m ²
Weight	6 Kg	6.1 Kg	6.5 Kg	6 Kg
Mounting	Wall and ceiling recessed	Wall and ceiling recessed	Wall and ceiling recessed	Wall and ceiling recessed
IP rating	IP40	IP40	IP40	IP40
Insulation class	I	I	I	I
Control gear	-	Electronic ballast	Electronic ballast	Dimmable constant current driver
Dimensions	A: 330 mm	A: 390 mm	A: 470 mm	A: 330 mm
Cut out for plasterboard	350 x 340 mm	350 x 340 mm	350 x 340 mm	350 x 340 mm
Lamp type	QT-DE12 (75 mm) 	TC-DEL/TEL 	TC-DEL/TEL 	LED 350 mA 
Lamp wattage	1 x 60W	1 x 26/32W	1 x 26/32W	1 x 6.5W
Luminous efficacy	-	-	-	810 lm - 3000K
Light distribution	-	-	-	Wide beam 120°
Fitting	R7s	Gx24q-3	Gx24q-3	-
Light colour	-	-	-	White 3000K White 2700K 4000K (on request)
Light hole	Ø 200 mm	Ø 200 mm	Ø 200 mm	Ø 200 mm
Voltage connection	220-240V · 50/60Hz	220-240V · 50/60Hz	220-240V · 50/60Hz	220-240V · 50/60Hz
CRI	-	-	-	>90
Emergency	-	-	1 hour	-
Energy efficiency class	A	A	A	A+
Note	-	-	-	Trailing-edge and leading-edge dimming (20 - 100%).

* The absorption capacity per m² calculated by the American organization TCNA (Tile Council of North America) is measured for an average room of 2.7 m in height and therefore expressed in m²



Private villa - ph - T. Pagani - Lugano



Private House - A. Castrignano - arch. R. Gasperoni - Milan

MARKUS



SISTEMA MODULARE PER CREARE CANALI DI LUCE.

Markus è un sistema modulare da interni in fila continua a scomparsa totale con corpo in AirCoral®, per installazione in parete e soffitto di cartongesso o laterizio che si compone nello spazio dando vita a un dettaglio di luce continua, un inserto luminoso che dà carattere agli spazi creando scenografie in cui la luce è assoluta protagonista.

Gli spazi diventano così materia da modellare tra le mani del progettista: la luce si trasforma in un canale di pura emozione.

MODULAR SYSTEM TO CREATE CHANNELS OF LIGHT.

Markus is totally disappearing continuous line modular indoor system made of AirCoral®, installable on plasterboard or brick walls and ceilings that arranges itself in the space giving life to a continuous detail of light, a bright insert that gives character to all spaces, creating settings where light plays the main part.

In this way, spaces become matter to be moulded by the hands of the designer: light becomes a channel of pure emotion.



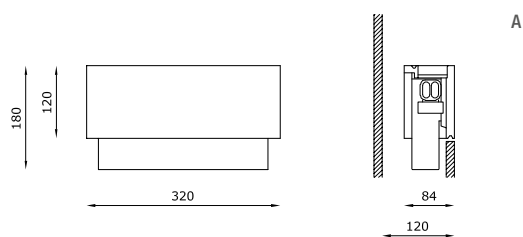

TECHNICAL FEATURES | ELECTRIFIED BODY

Code	6953.AC (fig. A)	6954.EB.AC (fig. A)
Type	Downlight 90° Wall recessed 90° 	Downlight 90° Wall recessed 90°
Material	AC: AirCoral®	AC: AirCoral®
Absorption capacity*	5.44 m ²	5.44 m ²
Weight	2 Kg	1.9 Kg
Mounting	Wall and ceiling recessed	Wall and ceiling recessed
IP rating	IP40	IP40
Insulation class	I	I
Control gear	Dimmable constant current driver	Electronic ballast
Cut out for plasterboard	130 x 330 mm	130 x 330 mm
Lamp type	LED 350 mA 	TC-DEL/TEL
Lamp wattage	1 x 6.5W	1 x 26/32W
Luminous efficacy	810 lm - 3000K	-
Light distribution	Wide beam 120°	-
Fitting	-	Gx24q-3
Light colour	White 3000K White 2700K 4000K (on request)	-
Light hole	-	-
Voltage connection	220-240V · 50/60Hz	220-240V · 50/60Hz
CRI	>90	-
Emergency	-	-
Energy efficiency class	A ⁺	A
Note	Trailing-edge and leading-edge dimming (20 - 100%).	-

* The absorption capacity per m³ calculated by the American organization TCNA (Tile Council of North America) is measured for an average room of 2.7 m in height and therefore expressed in m²



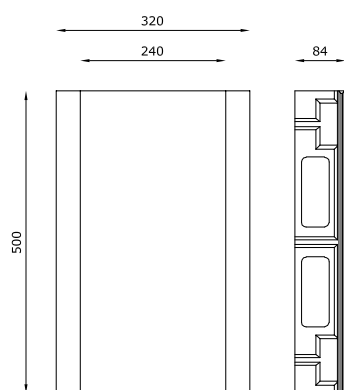

B

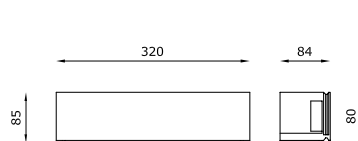

C

TECHNICAL FEATURES | MODULAR BODY

Code	6900.AC (fig. B)
Material	AC: AirCoral®
Absorption capacity*	17.97 m ²
Weight	8.3 Kg
IP rating	-
Cut out for plasterboard	(500 mm for each module installed) x 330 mm
Light hole	(500 mm for each module installed) x 240 mm
Note	-

TECHNICAL FEATURES | CLOSURE HEADPARTS

Code	6910.AC (fig. C)
Material	AC: AirCoral®
Absorption capacity*	4.33 m ²
Weight	-
IP rating	-
Cut out for plasterboard	90 x 330 mm
Light hole	-
Note	Supplied singularly it can be used in alternative to a further electrified body (code 6954.EB.AC / 6953.AC) to close a continuous line of the MARKUS product.

EXAMPLES OF INSTALLATION

Note Attention, the code 6900.AC must be installed for multiples of 500 mm and cannot be cut

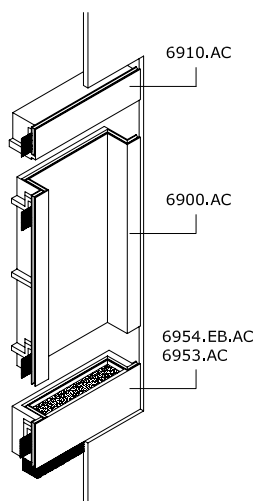

No. 1 electric body
 No. 1 modular body in AirCoral®
 No. 1 headpart

* The absorption capacity per m² calculated by the American organization TCNA (Tile Council of North America) is measured for an average room of 2.7 m in height and therefore expressed in m²



INVIDIA



INCASSO A LINEA CONTINUA.

Invidia, sistema modulare da interni in linea continua a scomparsa totale in AirCoral® per installazione in parete e soffitto di cartongesso.

L'integrazione totale consente di definire gli spazi architettonici sia a parete che a soffitto; la particolare sovrapposizione delle sorgenti luminose evita qualsiasi cono d'ombra e lo schermo in policarbonato satinato permette una diffusione omogenea e delicata, in grado di definire precisi percorsi di luce continui e concettualmente infiniti.

RECESSED FITTING WITH CONTINUOUS LINE.

The perfect combination of light, architecture and emotion: thanks to Invidia, a totally disappearing continuous line modular indoor system made of AirCoral®, installable on walls and plasterboard ceilings. This complete integration inside walls or ceilings allows the definition of architectural spaces; the particular overlapping of light sources avoids any kind of "shadow cone" and its satined polycarbonate screen allows for a uniform and delicate lighting, able to define precise, continuous bright paths.

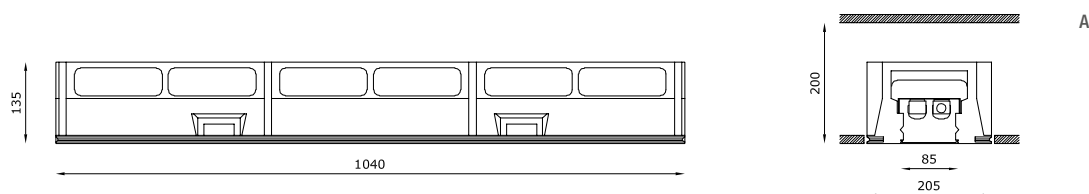

TECHNICAL FEATURES | BODYFRAME

Code	6640.AC (fig. A)	6650.AC (fig. A)
Material	AC: AirCoral®	AC: AirCoral®
Absorption capacity*	37.4 m ²	37.4 m ²
Weight	17 Kg	17 Kg
Mounting	Ceiling recessed	Wall recessed
IP rating	IP40	IP40
Cut out for plasterboard	(1040 mm for each module installed + 410 mm) x 215 mm	(1040 mm for each module installed + 410 mm) x 215 mm
Light hole	(1040 mm for each module installed) x 85 mm	(1040 mm for each module installed) x 85 mm
Note	-	-

TECHNICAL FEATURES | CLOSURE HEADPARTS

Code	6631.AC (fig. B)
Material	AC: AirCoral®
Absorption capacity*	18.12 m ²
Weight	-
Mounting	Ceiling and wall recessed
IP rating	-
Cut out for plasterboard	210 x 210 mm
Note	You need two headparts delivered as couple with a unique code 6631.AC to close a continuous line of the INVIDIA product (code 6640.AC / 6650.AC).

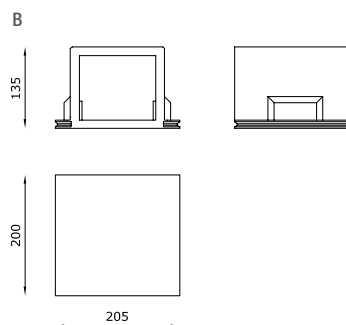

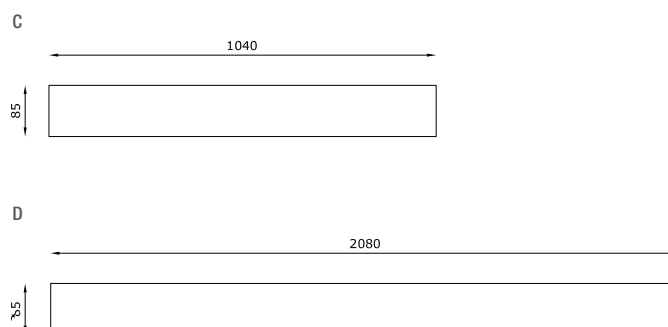

TECHNICAL FEATURES | PROTECTION SHIELD

Code	6600 (fig. C)	6601 (fig. D)
Material	Satin polycarbonate	Satin polycarbonate
Dimensions	1040 x 85 mm	2080 x 85 mm
Note	-	-



* The absorption capacity per m² calculated by the American organization TCNA (Tile Council of North America) is measured for an average room of 2.7 m in height and therefore expressed in m²

TECHNICAL FEATURES | LIGHT SOURCE

Code	6639
Type	Downlight 90° Wall recessed 90° 
Weight	-
IP rating	IP40
Insulation class	III
Control gear	Constant voltage driver
Lamp type	LED 24V 
Lamp wattage	1 x 28W
Luminous efficacy	2800 lm
Light distribution	Wide beam 120°
Fitting	-
Light colour	White 3000K White 2700K (on request)
Light hole	-
Voltage connection	220-240V / 24V · 50/60Hz
CRI	>90
Emergency	-
Energy efficiency class	A++
Note	-

EXAMPLE OF INSTALLATION

Note

Attention, the code 6640.AC / 6650.AC must be installed for multiples of 1040 mm and cannot be cut

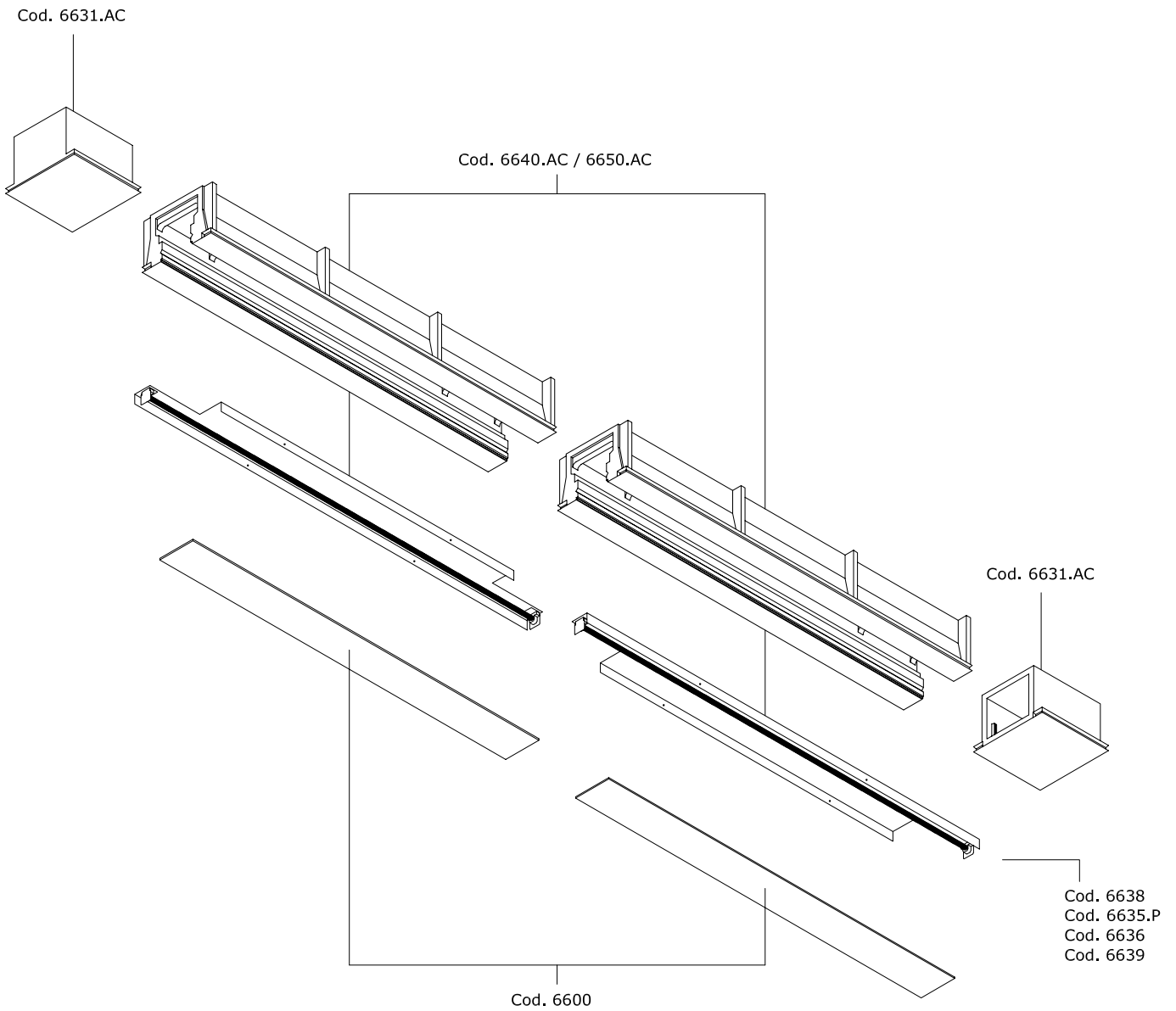





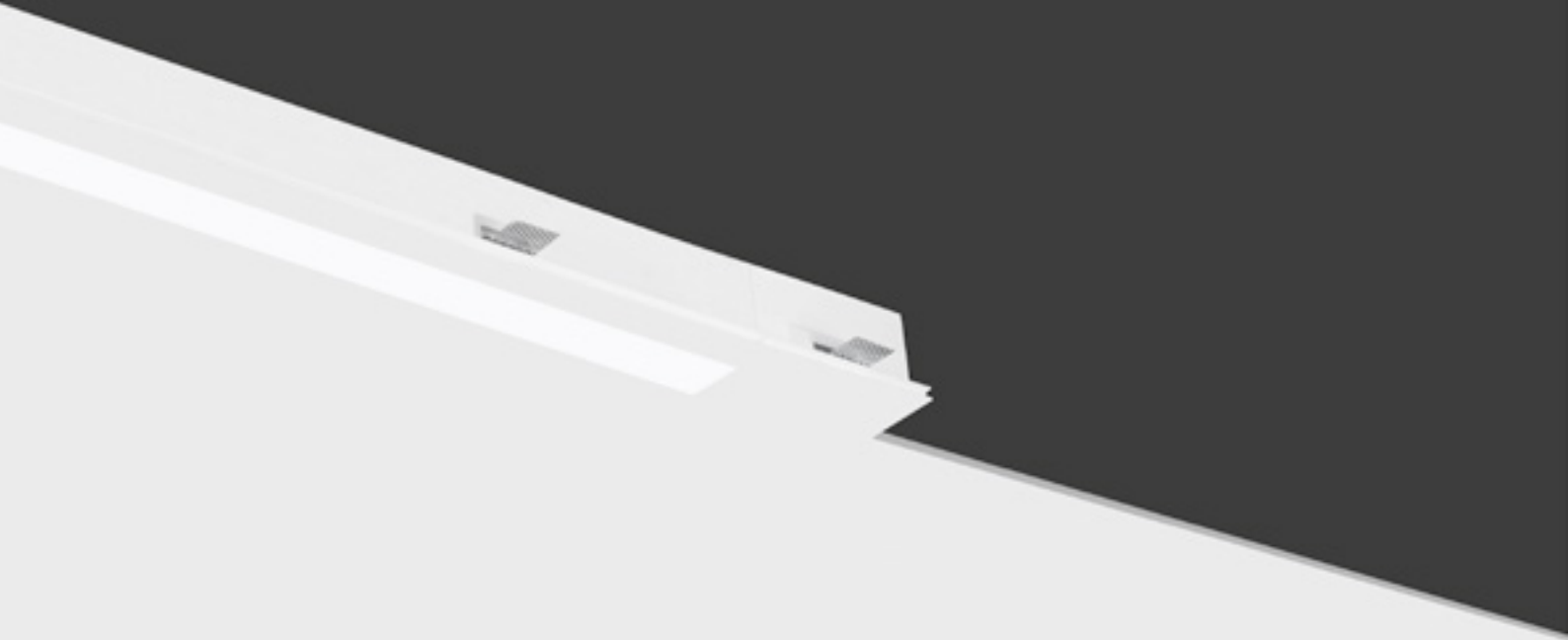

NOTHING



INCASSO A LINEA CONTINUA,
MINIME DIMENSIONI.

Nothing è un sistema modulare in linea continua da interni in Coral® con luce visibile di larghezza pari a 60 mm e lunghezze potenzialmente infinite, la cui integrazione totale con la superficie in cui viene installato offre la possibilità di definire spazi e volumi sia a parete che a soffitto, creando una perfetta unione tra luce, architettura ed emozione. La particolare sovrapposizione delle sorgenti luminose evita qualsiasi cono d'ombra, per un effetto uniforme e suggestivo.

*RECESSED FITTING WITH CONTINUOUS LINE,
MINIMUM DIMENSIONS.*

Nothing is an indoor continuous line modular system made of Coral® with a 60 mm visible line of light, whose integration with the surface it is installed upon allows the possibility to define architectural spaces and volumes both on walls and on ceilings, creating a perfect bond between light, architecture and emotion. The particular overlapping of light sources avoids any kind of shadow cone, for a uniform and evocative effect.

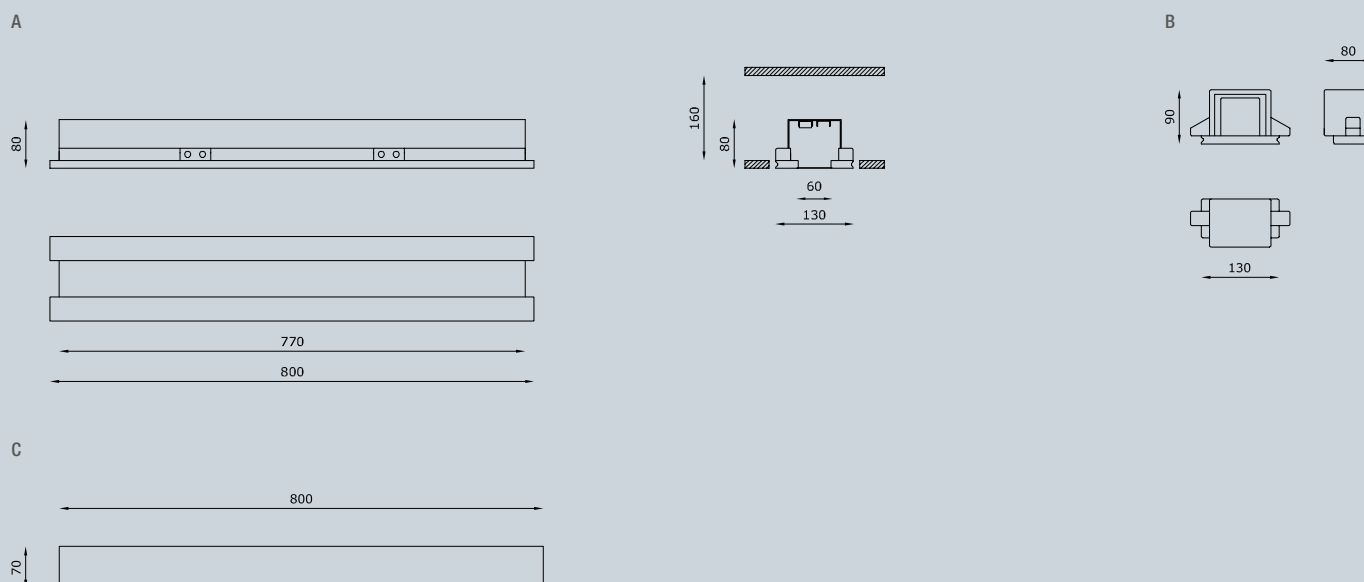

TECHNICAL FEATURES | BODYFRAME

Code	9010.00 (fig. A)	9013.00 (fig. A)
Type	Downlight 90°	Wall recessed 90°
Material	00: Coral®	00: Coral®
Weight	3.5 Kg	3.5 Kg
Mounting	Ceiling recessed	Wall recessed
IP rating	IP40	IP40
Cut out for plasterboard	(800 mm for each module installed + 160 mm) x 140 mm	(800 mm for each module installed + 160 mm) x 140 mm
Light hole	(800 mm for each module installed) x 60 mm	(800 mm for each module installed) x 60 mm
Note	-	-

TECHNICAL FEATURES | CLOSURE HEADPARTS

Code	9014.00 (fig. B)
Material	00: Coral®
Weight	1.2 Kg (couple)
Mounting	Wall and ceiling recessed
IP rating	-
Cut out for plasterboard	140 x 85 mm
Note	You need two headparts delivered as couple with a unique code 9014.00 to close a continuous line of the NOTHING product (code 9010.00 / 9013.00).

TECHNICAL FEATURES | PROTECTION SHIELD





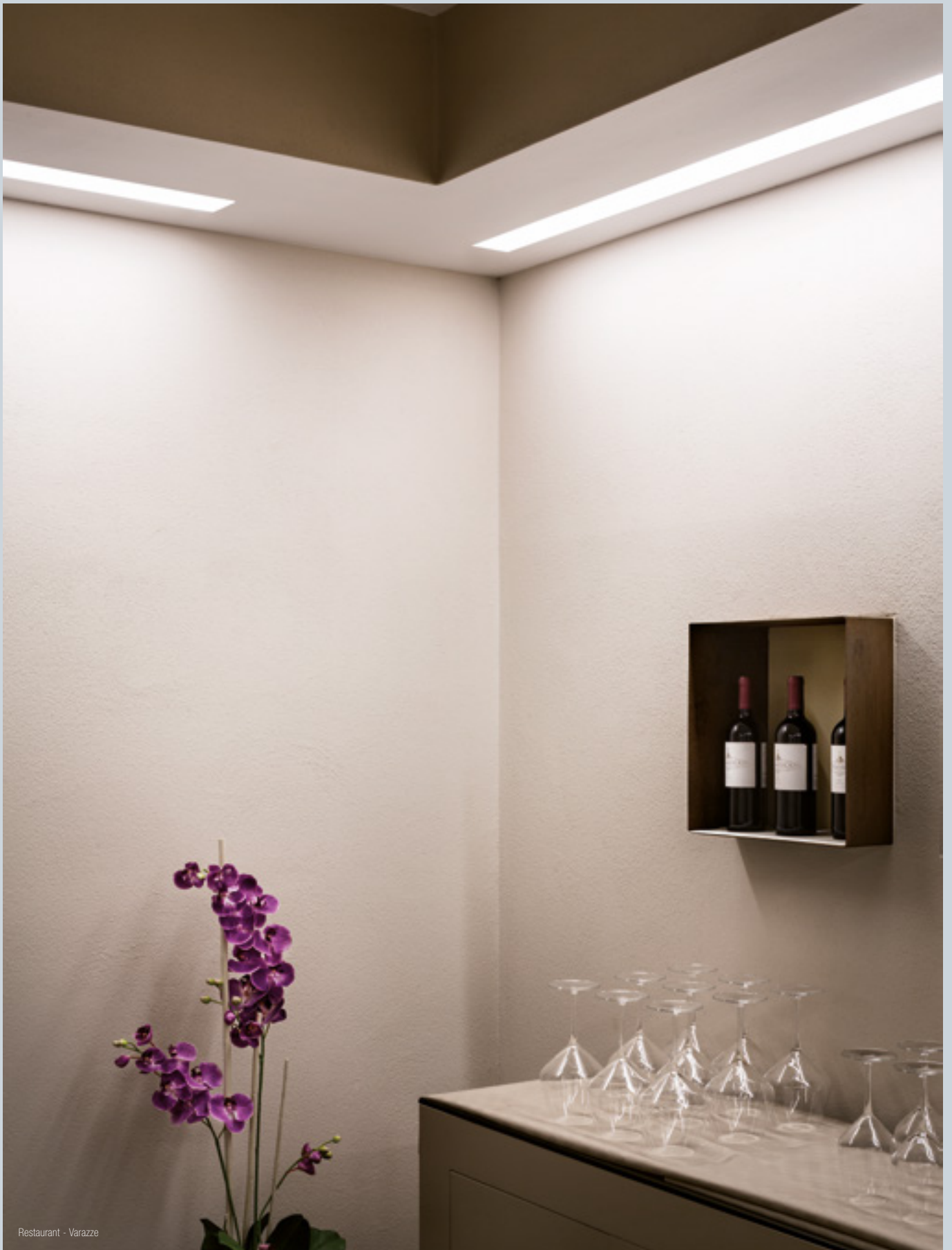

Code	9011.08 (fig. C)	9011.16	9011.24	9011.32
Material	Satin polycarbonate	Satin polycarbonate	Satin polycarbonate	Satin polycarbonate
Dimensions	800 x 70 mm	1600 x 70 mm	2400 x 70 mm	3200 x 70 mm
Note	-	-	-	-

Nothing



Restaurant - Varazze

TECHNICAL FEATURES | LIGHT SOURCE

Code	9017	9017.21	9018
Type	Downlight 90° Wall recessed 90° 	Downlight 90° Wall recessed 90° 	Downlight 90° Wall recessed 90° 
IP rating	IP20	IP20	IP20
Insulation class	II	II	II
Control gear	Electronic ballast	Electronic ballast	Constant voltage driver (not included)
Lamp type	T5 	T5 	LED 24V 
Lamp wattage	1 x 39W	1 x 21W	1 x 21W
Luminous efficacy	-	-	2100 lm
Light distribution	-	-	Wide beam 120°
Fitting	G5	G5	-
Light colour	White 2700K	White 2700K	White 3000K White 2700K (on request)
Light hole	-	-	-
Voltage connection	220-240V · 50/60Hz	220-240V · 50/60Hz	By driver (optional)
CRI	-	-	>90
Emergency	-	-	-
Energy efficiency class	A+	A+	A++
Note	-	-	-

OPTIONAL ACCESSORIES

product code	optional code	description	info
9018	H8024.25	Constant voltage driver	

EXAMPLE OF INSTALLATION

Note Attention, the code 9010.00 / 9013.00 must be installed for multiples of 800 mm and cannot be cut



GAP



SISTEMA DI LUCE CONTINUA E INDIRECTA.

Quando la luce deve essere protagonista indiscussa Gap si integra totalmente con le superfici, dando spazio al fascio luminoso: linearità, geometria, semplicità per un rigore che non è mai scontato e che racconta, a chi lo osserva, qualcosa di nuovo. Gap è un sistema modulare da interni in linea continua a scomparsa realizzato in AirCoral®, che definisce spazi e volumi architettonici sia a parete che a soffitto creando tagli di luce che esaltano le superfici adiacenti con effetto wall-washer.

La particolare sovrapposizione delle sorgenti luminose evita qualsiasi cono d'ombra: GAP, una volta installato, è studiato per diventare parte integrante delle superfici.

CONTINUOUS AND INDIRECT LIGHT SYSTEM.

When light has to be the main protagonist: Gap totally integrates with all surfaces, giving way to the light beam: linearity, geometry, simplicity for a never ordinary precision which tells something new to those who are looking at it. Gap is a continuous line modular system made of AirCoral®, able to define both wall and ceiling architectural spaces and volumes creating blades of light which exalt adjacent surfaces with their wall-washer effect. The particular overlapping of light sources avoids any kind of shadow cone: once installed, Gap is studied to become an integral part of false ceilings.

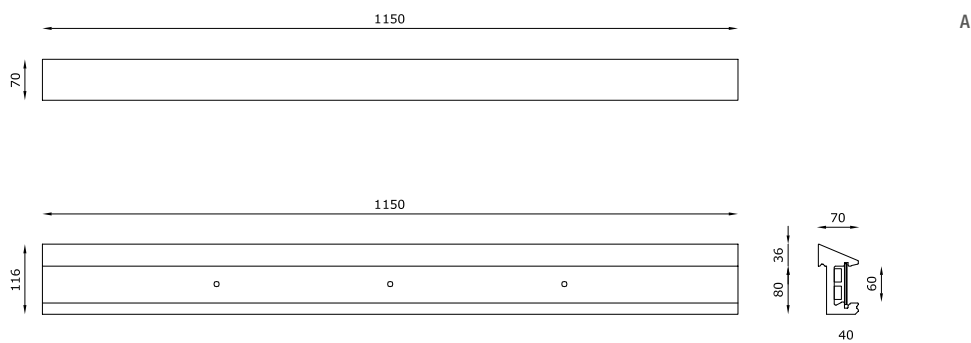

TECHNICAL FEATURES | BODYFRAME

Code	8300.AC (fig. A)	8310.AC (fig. A)
Material	AC: AirCoral®	AC: AirCoral®
Absorption capacity*	19.22 m ²	19.22 m ²
Weight	2.5 Kg	2.5 Kg
Mounting	Ceiling recessed	Wall recessed
IP rating	-	-
Cut out for plasterboard	1150 mm for each module installed	1150 mm for each module installed
Light hole	-	-
Note	-	-

TECHNICAL FEATURES | CLOSURE HEADPART

Code	8350.AC (fig. B)
Material	AC: AirCoral®
Absorption capacity*	0.9 m ²
Weight	-
Mounting	Ceiling and wall recessed
IP rating	-
Note	-

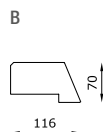

TECHNICAL FEATURES | ANGLE

Code	8330.AC (fig. C)	8340.AC (fig. D)
Material	AC: AirCoral®	AC: AirCoral®
Absorption capacity*	5 m ²	5 m ²
Weight	1.3 Kg	1.3 Kg
IP rating	-	-
Note	Internal angle	External angle

C. INTERNAL ANGLE

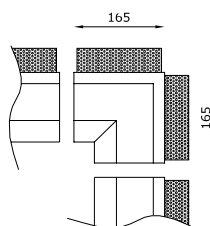

D. EXTERNAL ANGLE

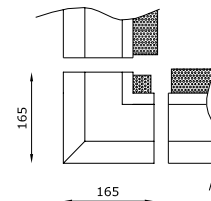

TECHNICAL FEATURES | PROTECTION SHIELD

Code	8320
Material	Satin polycarbonate
Dimensions	-
Note	Suitable only for LED light source (code 8108)

* The absorption capacity per m² calculated by the American organization TCNA (Tile Council of North America) is measured for an average room of 2.7 m in height and therefore expressed in m²



Private villa - Madonna di Campiglio

TECHNICAL FEATURES | LIGHT SOURCE

Code	8101	8102	8108
Type	Downlight 90° Wall recessed 90° 	Downlight 90° Wall recessed 90° 	Downlight 90° Wall recessed 90° 
Weight	-	-	-
IP rating	IP20	IP20	IP40
Insulation class	II	II	III
Control gear	Electronic ballast	Electronic ballast	Constant voltage driver (not included)
Lamp type	T5 (915 mm) 	T5 (1215 mm) 	LED 24V (900 mm) 
Lamp wattage	1 x 21W	1 x 28W	1 x 21W
Luminous efficacy	1850 lm	2470 lm	2100 lm
Light distribution	-	-	Wide beam 120°
Fitting	G5	G5	-
Light colour	White 2700K	White 2700K	White 3000K White 2700K (on request)
Light hole	-	-	-
Voltage connection	220-240V · 50/60Hz	220-240V · 50/60Hz	By driver (optional)
CRI	-	-	>90
Emergency	-	-	-
Energy efficiency class	A	A	A++
Note	Provided with lamp. Acrylic light-diffusing material. Provided with power-supply cable and connector for connection in series of multiple lamps.	Provided with lamp. Acrylic light-diffusing material. Provided with power-supply cable and connector for connection in series of multiple lamps.	-

OPTIONAL ACCESSORIES

product code	optional code	description	info
8108	H8024.25	Constant voltage driver	

EXAMPLE OF INSTALLATION

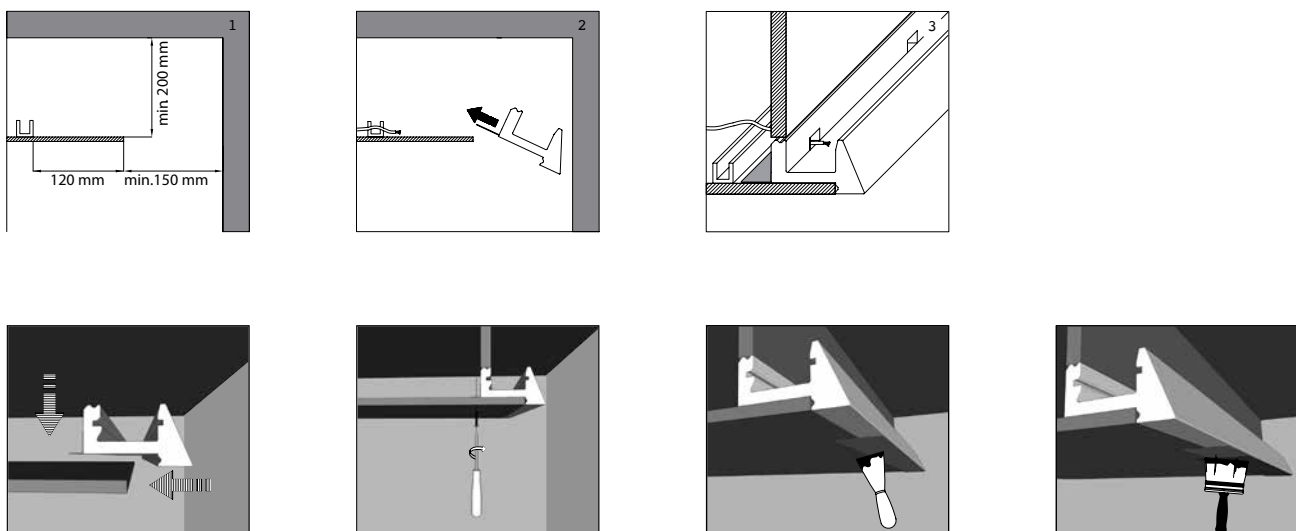

Design

Mammini+Candido

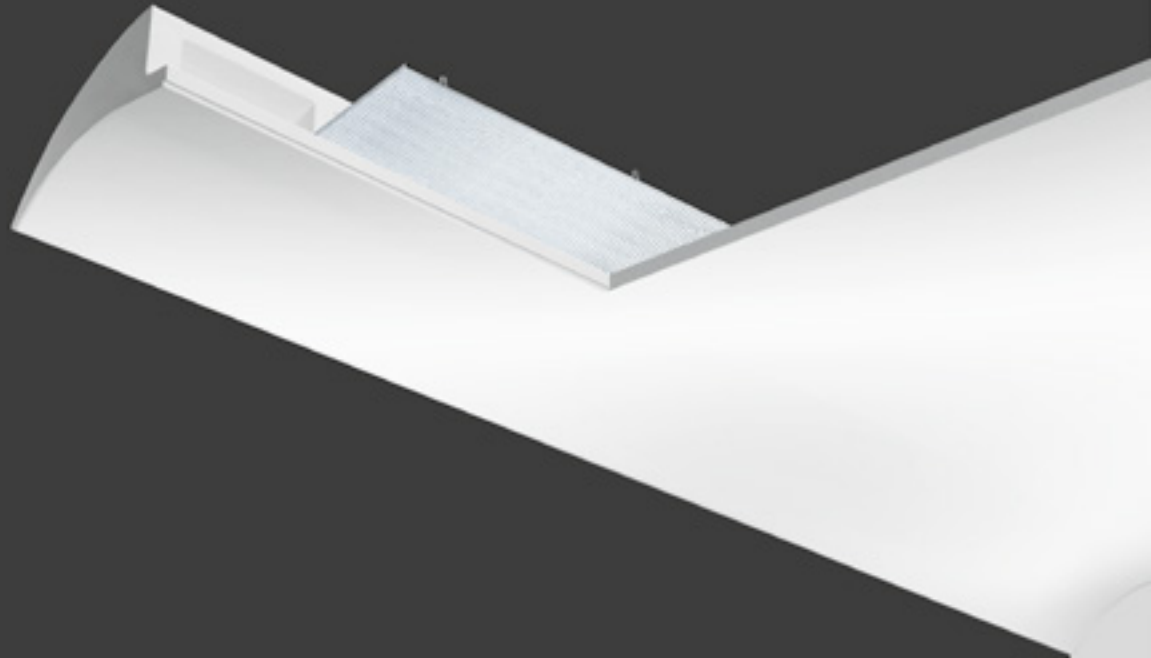

END



SISTEMA DI LUCE CONTINUA E INDIRECTA A SEMINCASSO.

Tagli di luce che esaltano le superfici, creando percorsi precisi all'interno degli spazi: la luce diventa protagonista grazie ad End, sistema modulare in linea continua da interni a scomparsa totale in AirCoral® per installazione in parete o soffitto di cartongesso. La particolare sovrapposizione delle sorgenti luminose evita qualsiasi cono d'ombra, per un effetto luminoso wall-washer puro e incredibilmente scenografico. La luce si trasforma in emozione, delicato elemento d'arredo per gli ambienti più raffinati.

SEMI-RECESSED CONTINUOUS AND INDIRECT LIGHT SYSTEM.

Cuts of light that exalt surfaces, creating precise paths inside spaces: light becomes a protagonist thanks to End, a continuous line modular system for indoor spaces made of AirCoral®, installable on walls or on plasterboard ceilings. The particular overlapping of light sources avoids any kind of shadow cone, for a pure and incredibly scenographic wall-washer lighting effect. Light becomes emotion, a delicate decorative element for the most refined environments.

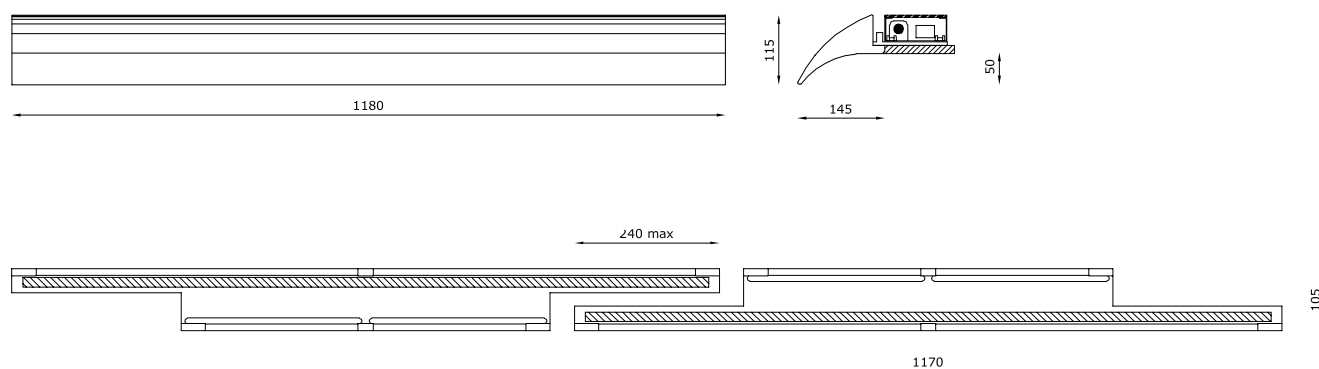

TECHNICAL FEATURES | BODYFRAME

Code	8200.AC
Material	AC: AirCoral®
Absorption capacity*	22.5 m²
Weight	6 Kg
Mounting	Ceiling and wall half recessed
IP rating	-
Cut out for plasterboard	1180 mm for each module installed
Light hole	-
Note	-

TECHNICAL FEATURES | PROTECTION SHIELD

Code	8210
Material	Satin polycarbonate
Note	Suitable only for T5 light source (code 8214 / 8215)

TECHNICAL FEATURES | LIGHT SOURCE

Code	8214	8215	8219
Type	Downlight 90° Wall recessed 90° 	Downlight 90° Wall recessed 90° 	Downlight 90° Wall recessed 90°
Weight	-	-	-
IP rating	IP20	IP20	IP40
Insulation class	I	I	III
Control gear	Electronic ballast	Electronic ballast	Constant voltage driver
Lamp type	T5 (Ø 16 mm) 	T5 (Ø 16 mm) 	LED 24V
Lamp wattage	1 x 28W	1 x 54W	1 x 28W
Luminous efficacy	-	-	2800 lm
Light distribution	-	-	wide beam 120°
Fitting	G5	G5	-
Light colour	-	-	White 3000K White 2700K (on request)
Light hole	-	-	-
Voltage connection	220-240V · 50/60Hz	220-240V · 50/60Hz	220-240V / 24V · 50/60Hz
CRI	-	-	>90
Emergency	-	-	-
Energy efficiency class	A+	A+	A++
Note	-	-	-

* The absorption capacity per m² calculated by the American organization TCNA (Tile Council of North America) is measured for an average room of 2.7 m in height and therefore expressed in m²

End



Armani Casa - Maçka Residences - Istanbul

EXAMPLE OF INSTALLATION

Optional
Cod. 8210

Cod. 8214 (28W)
Cod. 8215 (54W)
Cod. 8219 (28W)

Cod. 8200.AC

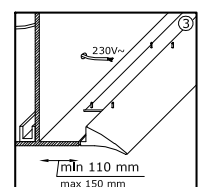
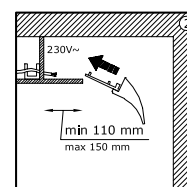
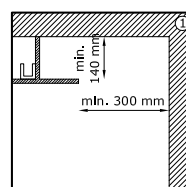
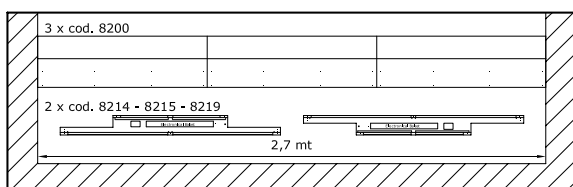
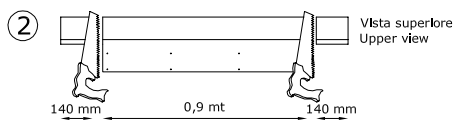
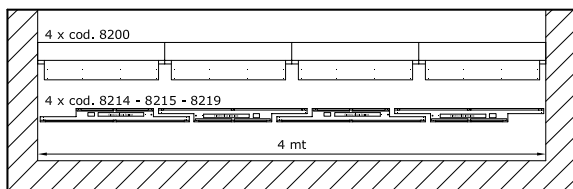
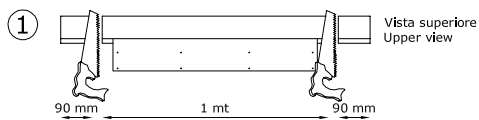
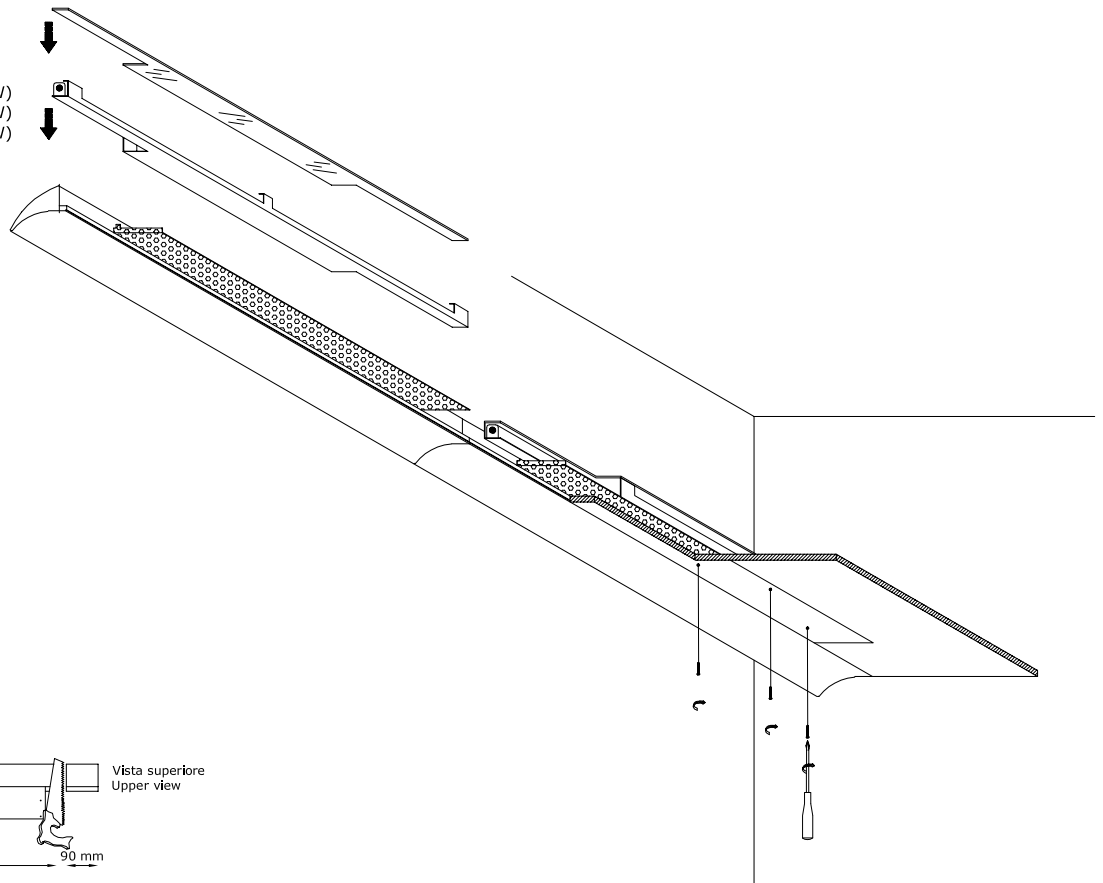

Design

Andrea Sensoli

UNLEAF



UN TAGLIO DI LUCE NELLA PARETE.



Unleaf è un incasso a scomparsa totale in AirCoral® installabile a parete e soffitto di cartongesso o laterizio che caratterizza gli ambienti: un taglio perfetto nella parete, un tocco originale all'interno del progetto architettonico. La superficie del prodotto affonda nella parete, che viene letteralmente modellata. Una luce d'accento, una lampada dal design ricercato, di una raffinatezza unica, che si riflette totalmente nella luce d'atmosfera emanata.

A SHAFT OF LIGHT ON THE WALL.

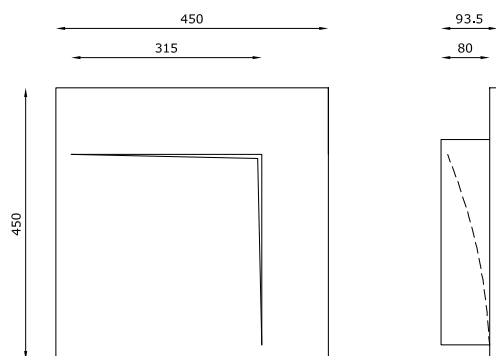
Unleaf is a total recessed luminaire made of AirCoral® and installable on plasterboard or brick walls and ceilings. A perfect cut on the wall, it shapes spaces and architectonic projects with an original luminescent touch. The product surface sinks into the wall, modelling it through light. An underlying, embellishing beam for a lamp of peculiar design and unique elegance; characteristics reflected in the suggestive atmosphere recreated in the environment by the luminaire.



TECHNICAL FEATURES

Code	2998.AC
Type	Wall and ceiling recessed 
Material	AC: AirCoral®
Absorption capacity*	22.8 m ²
Weight	10.4 Kg
Mounting	Wall and ceiling mounting
IP rating	IP20
Insulation class	I
Control gear	Dimmable constant current driver
Cut out for plasterboard	460 x 460 mm
Lamp type	LED 350mA 
Lamp wattage	2 x 6.5W
Luminous efficacy	2 x 810 lm - 3000K
Light distribution	Wide beam 120°
Fitting	-
Light colour	White 3000K White 2700K 4000K (on request)
Light hole	-
Voltage connection	220-240V · 50/60Hz
CRI	>90
Emergency	-
Energy efficiency class	A ⁺
Note	Trailing-edge and leading-edge dimming (20 - 100%).

* The absorption capacity per m² calculated by the American organization TCNA (Tile Council of North America) is measured for an average room of 2.7 m in height and therefore expressed in m²



SUPERFUTUREDESIGN™



Design

Andrea Sensoli

LEAF



LA PARETE SI PLASMA ALLA LUCE.



Una luce unica quella di Leaf, un semi incasso a scomparsa totale, installabile orizzontalmente o verticalmente, a parete o a soffitto di cartongesso o laterizio. Il suo design evoca eleganza e purezza: studiato per diventare parte integrante della parete o del controsoffitto, la sua applicazione crea un effetto inedito. Disegnato con l'obiettivo di esaltare le speciali caratteristiche del materiale AirCoral®, esprime una perfetta sintesi tra la purezza formale che caratterizza il prodotto e la materia.

THE WALL MOULDS ITSELF TO THE LIGHT.

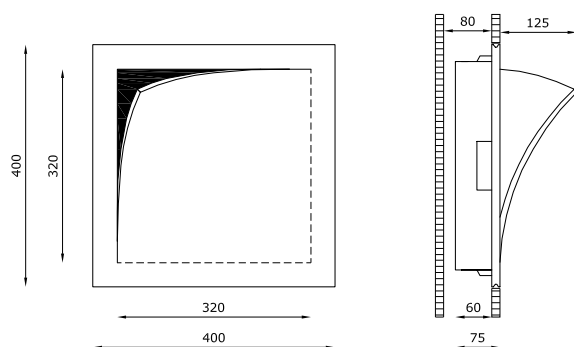
The light of Leaf, an indoor semi recessed luminaire, installable horizontally or vertically on plasterboard or brick walls or ceilings, is unique. Its design evokes elegance and purity: specifically studied to become an integral part of walls or false ceilings, its installation creates innovative effects. Designed to exalt the special features of AirCoral®, it expresses a perfect combination of the formal purity typical of this product and the features of the material.



TECHNICAL FEATURES

Code	2988.AC
Type	Wall and ceiling half recessed 
Material	AC: AirCoral®
Absorption capacity*	26.2 m ²
Weight	9.2 Kg
Mounting	Wall and ceiling mounting
IP rating	IP20
Insulation class	I
Control gear	Dimmable constant current driver
Cut out for plasterboard	410 x 410 mm
Lamp type	LED 350mA 
Lamp wattage	1 x 6.5W
Luminous efficacy	810 lm - 3000K
Light distribution	Wide beam 120°
Fitting	-
Light colour	White 3000K White 2700K 4000K (on request)
Light hole	-
Voltage connection	220-240V · 50/60Hz
CRI	>90
Emergency	-
Energy efficiency class	A ⁺
Note	Trailing-edge and leading-edge dimming (20 - 100%).

* The absorption capacity per m² calculated by the American organization TCNA (Tile Council of North America) is measured for an average room of 2.7 m in height and therefore expressed in m²



SUPERFUTUREDESIGN™



Private House - ASZ Architetti

Design

Andrea Castrignano

NASTRO



SEMI INCASSO.

Un magico effetto sulla parete, un'elegante fascia luminosa che arreda gli ambienti in cui viene installata: Nastro, semi incasso a scomparsa totale in AirCoral®, adatto per installazione in parete o soffitto di cartongesso o laterizio, compone armonie di luce, impreziosendo le superfici con un design unico e ricercato. La presenza del vetro satinato permette alla luce di diffondersi nello spazio delicatamente. Studiata per diventare parte integrante del muro o del controsoffitto, installabile sia in orizzontale che verticale, la sua applicazione crea "movimento" delle forme e dei volumi, per un effetto luminoso dal fascino discreto.



SEMI RECESSED.

A magical effect on the wall, an elegant bright band that decorates the environments it is installed in: Nastro, a totally disappearing semi recessed luminaire made of AirCoral® installable on plasterboard or brick walls and ceilings, composes harmonies of light, enhancing architectures with a unique and refined design. The satin glass allows the light to spread in a very delicate way. Designed for becoming an integral part of the wall or of the false ceiling and installable both horizontally or vertically, it creates a "moving" effect of shapes and volumes, reproducing an atmosphere of discreet fascination.

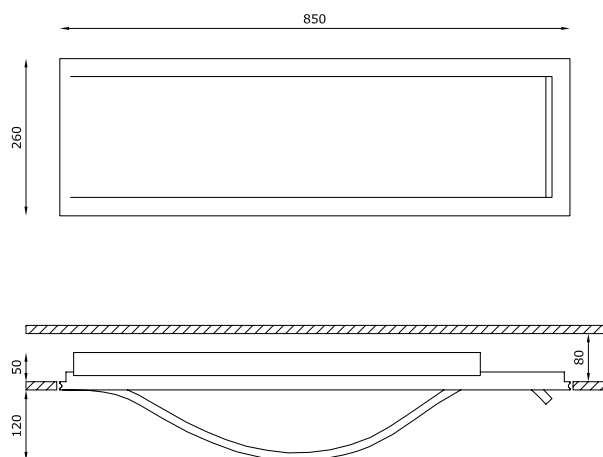



TECHNICAL FEATURES

Code	2974.AC	2975.P.AC	2979.AC
Type	Wall and ceiling half recessed	Wall and ceiling half recessed	Wall and ceiling half recessed
Material	AC: AirCoral®	AC: AirCoral®	AC: AirCoral®
Absorption capacity*	38.52 m²	38.52 m²	38.52 m²
Weight	11 Kg	11 Kg	11 Kg
Mounting	Wall and ceiling mounting	Wall and ceiling mounting	Wall and ceiling mounting
IP rating	IP40	IP40	IP40
Insulation class	I	I	I
Control gear	Electronic ballast	Dimmable electronic ballast	Dimmable constant current driver
Cut out for plasterboard	860 x 270 mm	860 x 270 mm	860 x 270 mm
Lamp type	TC-TEL 	TC-TEL 	LED 350mA 
Lamp wattage	2 x 32W	2 x 32W	2 x 6.5W
Luminous efficacy	-	-	2 x 810 lm - 3000K
Light distribution	-	-	Wide beam 120°
Fitting	Gx24q-3	Gx24q-3	-
Light colour	-	-	White 3000K White 2700K 4000K (on request)
Light hole	-	-	-
Voltage connection	220-240V · 50/60Hz	220-240V · 50/60Hz	220-240V · 50/60Hz
CRI	-	-	>90
Emergency	-	-	-
Energy efficiency class	A	A	A+
Note	Extra white satin glass fixed by screws. Vertical and horizontal mounting.	Extra white satin glass fixed by screws. Vertical and horizontal mounting.	Extra white satin glass fixed by screws. Vertical and horizontal mounting.
		Standard: dimmable switch dim. / push (on request: dimmable 1-10V or DALI).	Trailing-edge and leading-edge dimming (20 - 100%).

* The absorption capacity per m² calculated by the American organization TCNA (Tile Council of North America) is measured for an average room of 2.7 m in height and therefore expressed in m²



Private House - A. Castrignano - Rome



Design

Mammini+Candido



MOTUS



SEMI INCASSO.







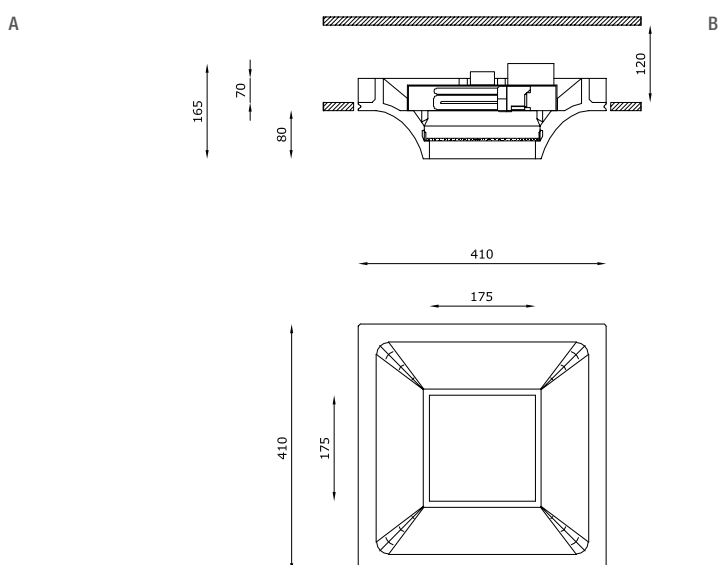
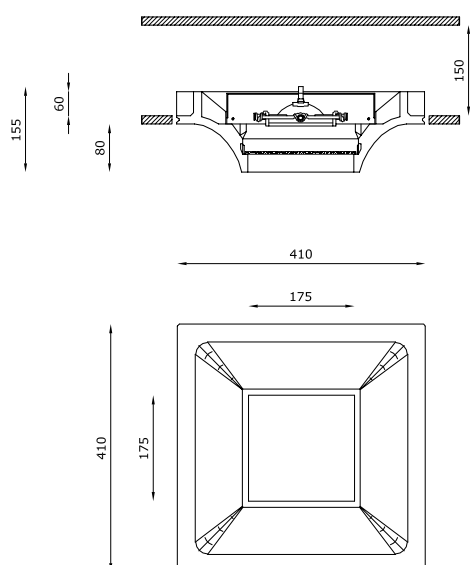



Regalare movimento alle forme e ai volumi attraverso l'illuminazione: grazie a Motus, semincasso a scomparsa totale da interni in AirCoral® per installazione in soffitto di cartongesso o laterizio, gli spazi prendono vita in un gioco di luci e ombre. L'apparecchio diventa parte integrante del controsoffitto, inserendosi nello spazio con delicata eleganza.

SEMI RECESSED.

Giving movement to shapes and volumes through lighting: thanks to Motus, an indoor totally disappearing semi recessed luminaire made of AirCoral®, installable on plasterboard or brick ceilings, architectures come alive in a play of lights and shadows. This product becomes an integral part of the false ceiling, inserting itself in the space with delicate elegance.



TECHNICAL FEATURES

Code	6361.AC (fig.A)	6366.AC (fig.B)	6368.AC (fig.B)	6461.AC (fig.B)	6463.AC (fig.B)
Type	Tiltable downlight ± 30° 	Downlight 90° 	Downlight 90° 	Downlight 90° 	Downlight 90° 
Material	AC: AirCoral®	AC: AirCoral®	AC: AirCoral®	AC: AirCoral®	AC: AirCoral®
Absorption capacity*	20.35 m²	20.35 m²	20.35 m²	20.35 m²	20.35 m²
Weight	6.2 Kg	6.3 Kg	6.4 Kg	8.5 Kg	8.5 Kg
Mounting	Ceiling half recessed	Ceiling half recessed	Ceiling half recessed	Ceiling half recessed	Ceiling half recessed
IP rating	IP40	IP40	IP40	IP40	IP40
Insulation class	III	I	I	I	I
Control gear	Dimmable electronic transformer	Electronic ballast	Electronic ballast	Constant current electronic driver	Dimmable constant current driver
Cut out for plasterboard	420 x 420 mm	420 x 420 mm	420 x 420 mm	420 x 420 mm	420 x 420 mm
Lamp type	QR 111 	TC-TEL 	TC-TEL 	LED 1050 mA 	LED 350 mA 
Lamp wattage	1 x 100W max	2 x 26/32W	2 x 26W	1 x 40W	2 x 6.5W
Luminous efficacy	-	-	-	4680 lm - 3000K	2 x 810 lm - 3000K
Light distribution	-	-	-	Wide beam 40°	Wide beam 120°
Fitting	G53	Gx24q-3	Gx24q-3	-	-
Light colour	-	-	-	White 3000K White 2700K 4000K (on request)	White 3000K White 2700K 4000K (on request)
Light hole	175 x 175 mm	175 x 175 mm	175 x 175 mm	175 x 175 mm	175 x 175 mm
Voltage connection	220-240V / 12V · 50/60Hz	220-240V · 50/60Hz	220-240V · 50/60Hz	220-240V · 50/60Hz	220-240V · 50/60Hz
CRI	-	-	-	>90	>90
Emergency	-	-	1 hour	-	-
Energy efficiency class	A	A	A	A++	A+
Note	Extra white satin glass. Recessed glass 30 mm.	Extra white satin glass. Recessed glass 30 mm.	Extra white satin glass. Recessed glass 30 mm.	Extra white satin glass. Recessed glass 30 mm.	Extra white satin glass. Recessed glass 30 mm. Trailing-edge and leading-edge dimming (20 - 100%).

OPTIONAL ACCESSORIES

product code	optional code	description	info
6361.AC	00010KIT	Kit LED dimmable	Bulb 10W · 12V

* The absorption capacity per m² calculated by the American organization TCNA (Tile Council of North America) is measured for an average room of 2.7 m in height and therefore expressed in m²

Design
Mammini+Candido



FLEXI



SEMI INCASSO.

Una luce che si adatta a qualsiasi ambiente, un apparecchio dal design esclusivo che crea movimento e dinamismo: Flexi, semincasso a scomparsa totale da interni in AirCoral® per installazione in parete e soffitto di cartongesso o laterizio, una volta installato diventa parte integrante della superficie. La presenza del vetro satinato e fissato con viti bianche in polycarbonato permette alla luce di diffondersi nello spazio delicatamente.

SEMI RECESSED.

A light that adapts itself to any architecture, a fixture with an exclusive design, creating movement and dynamism: Flexi, an indoor totally disappearing semi recessed luminaire made of AirCoral®, installable on plasterboard or brick walls and ceilings, has the capacity to become an integral part of the surface it is placed on. The satin glass, fixed with white polycarbonate screws, allows the light to spread delicately within the spaces.

Recessed

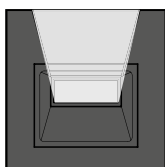
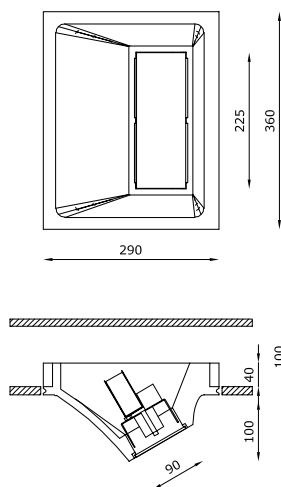

max 26W Gx24q-3
max 32W Gx24q-3
2 x 6.5W - 350 mA LED

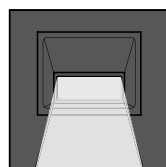

max 26W Gx24q-3
2 x 6.5W - 350 mA LED

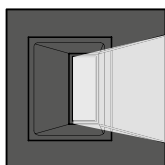



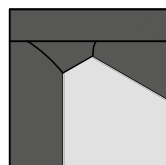

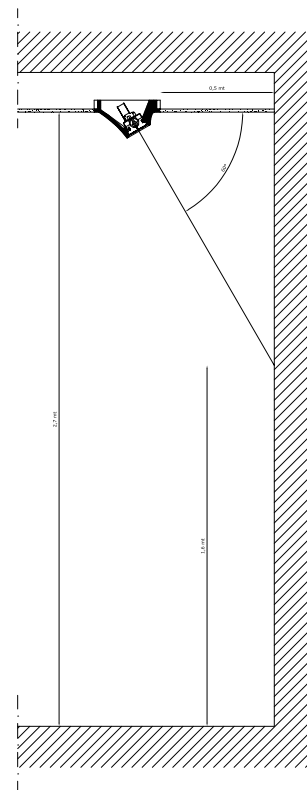

max 26W Gx24q-3
max 32W Gx24q-3
2 x 6.5W - 350 mA LED



max 26W Gx24q-3
max 32W Gx24q-3
max 150W R7s
2 x 6.5W - 350 mA LED



TECHNICAL FEATURES

Code	6478.AC	6479.PAC	6471.AC
Type	Downlight 60° 	Downlight 60° 	Downlight 60° 
Material	AC: AirCoral®	AC: AirCoral®	AC: AirCoral®
Absorption capacity*	11.67 m ²	11.67 m ²	11.67 m ²
Weight	7.7 Kg	7.5 Kg	7.5 Kg
Mounting	Ceiling and wall half recessed	Ceiling and wall half recessed	Ceiling and wall half recessed
IP rating	IP40	IP40	IP40
Insulation class	I	I	I
Control gear	Electronic ballast	Dimmable electronic ballast	Dimmable constant current driver
Cut out for plasterboard	300 x 370 mm	300 x 370 mm	300 x 370 mm
Lamp type	TC-TEL 	TC-TEL 	LED 350 mA 
Lamp wattage	1 x 32W	1 x 32W	2 x 6.5W
Luminous efficacy	-	-	2 x 810 lm - 3000K
Light distribution	-	-	Wide beam 120°
Fitting	Gx24q-3	Gx24q-3	-
Light colour	-	-	White 3000K White 2700K 4000K (on request)
Light hole	90 x 225 mm	90 x 225 mm	90 x 225 mm
Voltage connection	220-240V · 50/60Hz	220-240V · 50/60Hz	220-240V · 50/60Hz
CRI	-	-	>90
Emergency	1 hour	-	-
Energy efficiency class	A	A	A+
Note	Extra white satin glass fixed by screws. Recessed glass 5 mm.	Extra white satin glass fixed by screws. Recessed glass 5 mm.	Extra white satin glass fixed by screws. Recessed glass 5 mm.
		Standard: dimmable switch dim. / push (on request: dimmable 1-10V or DALI).	Trailing-edge and leading-edge dimming (20 - 100%).

* The absorption capacity per m² calculated by the American organization TCNA (Tile Council of North America) is measured for an average room of 2.7 m in height and therefore expressed in m²



Surface

Light and design in a unique body



PIPEDO



La geometria è il punto di partenza per la realizzazione di un prodotto dal design pulito e minimale: Pipedo è una lampada a parete da interni in AirCoral® che genera una luce indiretta, rivolta verso l'alto con il preciso obiettivo di accendere e portare a nuova vita i dettagli più nascosti. La luce diventa materia con cui plasmare gli ambienti, elemento concreto per una qualità visiva ottimale.

Geometry is the starting point to create a product with a clean and minimal design: Pipedo is an indoor wall lamp made of AirCoral® that emits an indirect light, facing upwards and with a precise goal, to highlight and bring new life to the most hidden details. Light becomes substance to mould spaces with, a concrete element for an optimal visual quality.

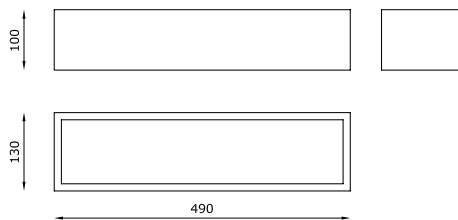

TECHNICAL FEATURES

Code	2901.AC	2902.AC	2904.EB.AC	2906.AC	2907.PAC	2908.AC
Type	Wall lamp 	Wall lamp 	Wall lamp 	Wall lamp 	Wall lamp 	Wall lamp
Material	AC: AirCoral®	AC: AirCoral®	AC: AirCoral®	AC: AirCoral®	AC: AirCoral®	AC: AirCoral®
Absorption capacity*	13.31 m²	13.31 m²	13.31 m²	13.31 m²	13.31 m²	13.31 m²
Mounting	Wall mounting	Wall mounting	Wall mounting	Wall mounting	Wall mounting	Wall mounting
IP rating	IP20	IP20	IP20	IP20	IP20	IP20
Insulation class	I	I	I	I	I	I
Control gear	-	-	Electronic ballast	Electronic ballast	Dimmable electronic ballast	Dimmable constant current driver
Lamp type	A 60 	QT-DE12 (115 mm) 	TC-L 	TC-L 	TC-L 	LED 350 mA
Lamp wattage	1 x 100W max	1 x 150W max	1 x 36W	1 x 36W	1 x 36W	1 x 8W
Luminous efficacy	-	-	-	-	-	1340 lm - 3000K
Light distribution	-	-	-	-	-	Wide beam 120°
Fitting	E27	R7s	2G11	2G11	2G11	-
Light colour	-	-	-	-	-	White 3000K White 2700K 4000K (on request)
Voltage connection	220-240V · 50/60Hz	220-240V · 50/60Hz	220-240V · 50/60Hz	220-240V · 50/60Hz	220-240V · 50/60Hz	220-240V · 50/60Hz
CRI	-	-	-	-	-	>90
Emergency	-	-	-	1 hour	-	-
Energy efficiency class	A+	A	A	A	A	A+
Note	-	-	-	-	Standard: dimmable switch dim. / push (on request: dimmable 1-10V or DALI).	Trailing-edge and leading-edge dimming (20 - 100%). Satin glass included.

OPTIONAL ACCESSORIES

product code	optional code	description	info
2904.EB.AC / 2906.AC 2907.PAC	2900	Glass safety screen	Protection IP40

* The absorption capacity per m² calculated by the American organization TCNA (Tile Council of North America) is measured for an average room of 2.7 m in height and therefore expressed in m²



PIPEDINO INDIRECT





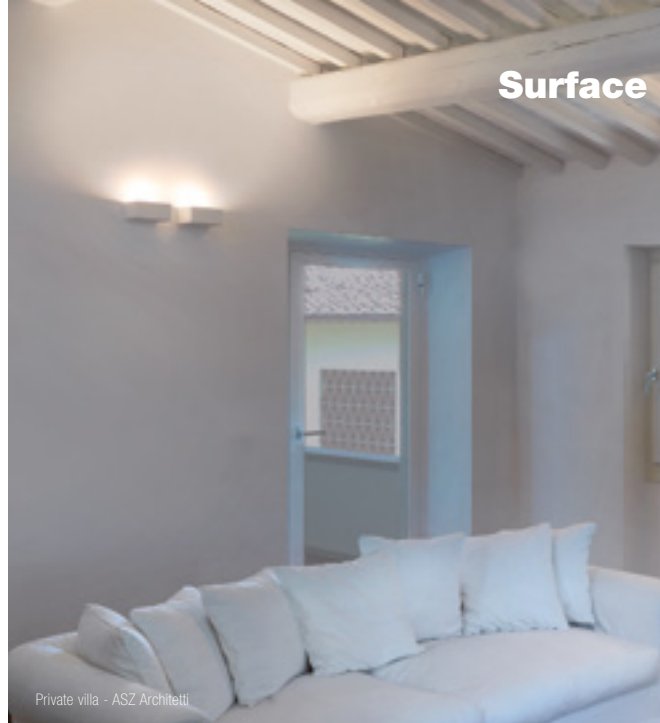
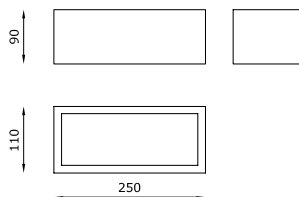

Un'illuminazione che esalta i dettagli, guidando lo sguardo verso l'alto: Pipedino Indirect è una lampada da interni a parete in AirCoral®, un parallelepipedo che lascia pieno potere alla luce, protagonista indiscussa all'interno del progetto architettonico. Valorizzare, giocando con le simmetrie, con le forme e con una potenza visiva senza pari.

A luminaire that exalts the details, guiding the eye upwards: Pipedino Indirect is an indoor wall lamp in AirCoral®, a parallelepiped that gives full power to light, the undisputed protagonist inside the architectural project. Enhancing, while playing with symmetries, with shapes and with an unparalleled visual power.



TECHNICAL FEATURES

	2937.AC	2936.AC
Code	2937.AC	2936.AC
Type	Wall lamp 	Wall lamp 
Material	AC: AirCoral®	AC: AirCoral®
Absorption capacity*	5.47 m ²	5.47 m ²
Mounting	Wall mounting	Wall mounting
IP rating	IP20	IP20
Insulation class	I	I
Control gear	Electronic ballast	Dimmable constant current driver
Lamp type	TC-DEL 	LED 350 mA 
Lamp wattage	1 x 26W	1 x 6.5W
Luminous efficacy	-	810 lm - 3000K
Light distribution	-	Wide beam 120°
Fitting	G24q-3	-
Light colour	-	White 3000K White 2700K 4000K (on request)
Voltage connection	220-240V · 50/60Hz	220-240V · 50/60Hz
CRI	-	>90
Emergency	-	-
Energy efficiency class	A	A+
Note	-	Trailing-edge and leading-edge dimming (20 - 100%). Satin glass included.

OPTIONAL ACCESSORIES

<i>product code</i>	<i>optional code</i>	<i>description</i>	<i>info</i>
2937.AC	2920	Glass safety screen	Protection IP40

* The absorption capacity per m³ calculated by the American organization TCNA (Tile Council of North America) is measured for an average room of 2.7 m in height and therefore expressed in m²



PIPEDO DIRECT







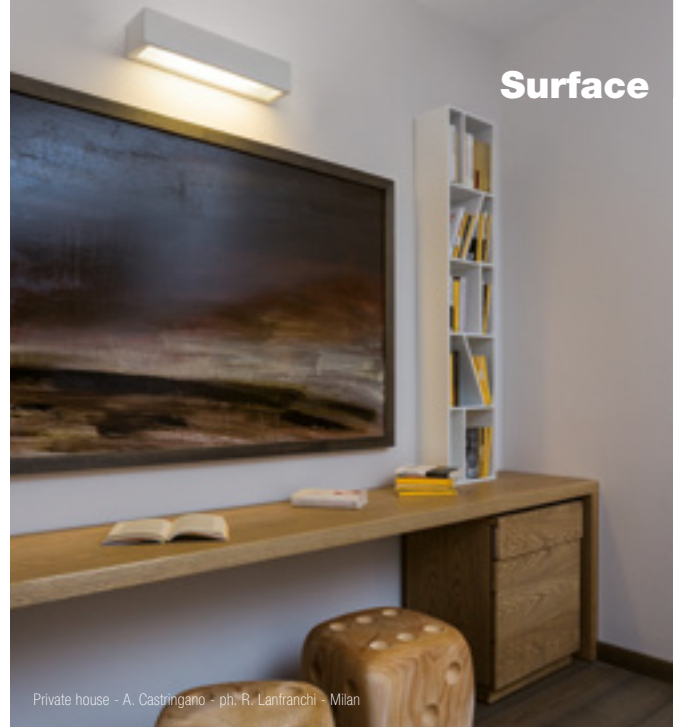
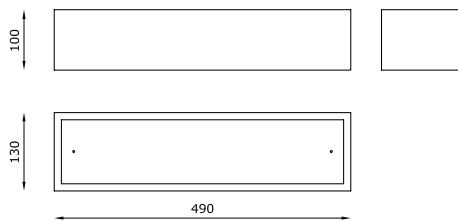

Pipedo Direct è una lampada a parete da interni in AirCoral® che genera una luce diretta e delicata, grazie alla presenza del vetro satinato fissato con viti in policarbonato bianche, che consente una fruizione funzionale, agevole e confortevole, assicurando la migliore visione possibile.

Pipedo Direct is an indoor wall lamp made of AirCoral® that emits a direct and delicate light thanks to the presence of the satin glass fixed with white polycarbonate screws. This allows a functional, effortless and comfortable use, ensuring the best possible vision.



Private house - A. Castrignano - ph. R. Lanfranchi - Milan

TECHNICAL FEATURES

Code	2964.EB.AC	2965.AC	2968.AC
Type	Wall lamp 	Wall lamp 	Wall lamp 
Material	AC: AirCoral®	AC: AirCoral®	AC: AirCoral®
Absorption capacity*	13.31 m ²	13.31 m ²	13.31 m ²
Mounting	Wall mounting	Wall mounting	Wall mounting
IP rating	IP40	IP40	IP40
Insulation class	I	I	I
Control gear	Electronic ballast	Dimmable electronic ballast	Dimmable constant current driver
Lamp type	TC-L 	TC-L 	LED 350 mA 
Lamp wattage	1 x 36W	1 x 36W	1 x 8W
Luminous efficacy	-	-	1340 lm - 3000K
Light distribution	-	-	Wide beam 120°
Fitting	2G11	2G11	-
Light colour	-	-	White 3000K White 2700K 4000K (on request)
Voltage connection	220-240V · 50/60Hz	220-240V · 50/60Hz	220-240V · 50/60Hz
CRI	-	-	>90
Emergency	-	-	-
Energy efficiency class	A	A	A+
Note	Extra white frosted glass fixed with polycarbonate screws.	Extra white frosted glass fixed with polycarbonate screws.	Extra white frosted glass fixed with polycarbonate screws.
		Standard: dimmable switch dim. / push (on request: dimmable 1-10V or DALI).	Trailing-edge and leading-edge dimming (20 - 100%).

* The absorption capacity per m² calculated by the American organization TCNA (Tile Council of North America) is measured for an average room of 2.7 m in height and therefore expressed in m²



PIPEDINO DIRECT



Un apparecchio il cui obiettivo è lasciare pieno potere alla bellezza della luce, che si inserisce nello spazio con determinazione: Pipedino Direct è una lampada da parete da interni in AirCoral®.



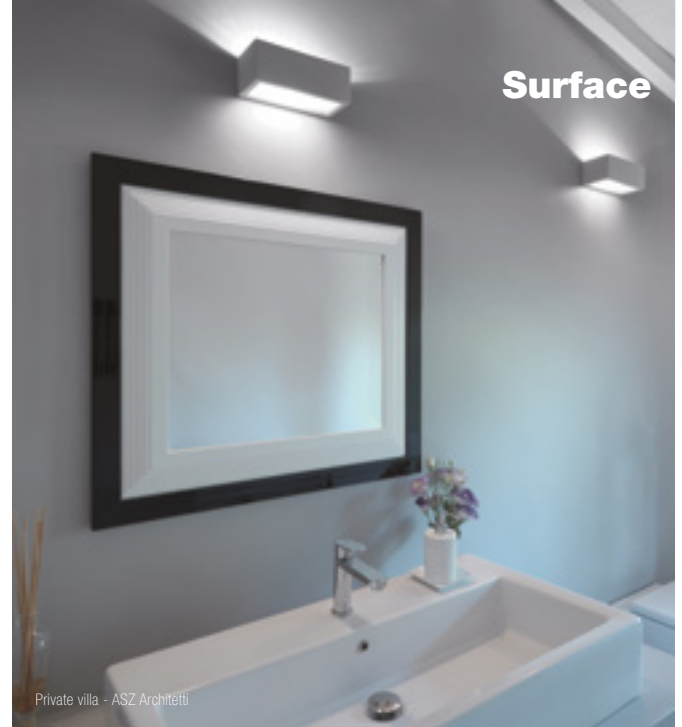
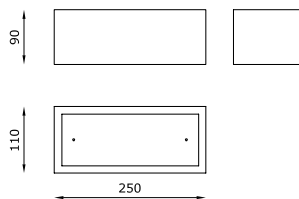

Il prodotto incontra le superfici e le esalta: la luce, diretta verso il basso, è filtrata dal vetro satinato fissato con viti in polycarbonato bianche.

A luminaire whose goal is to give full power to the beauty of light, that enters the space with determination: Pipedino Direct is an indoor wall lamp in AirCoral®, a precious tool in the hands of the designer's mind.

A product that comes together with surfaces, exalting them: the light turns downwards, seeping in through the satin glass fixed with white polycarbonate screws.



TECHNICAL FEATURES

Code	2927.AC	2928.AC
Type	Wall lamp 	Wall lamp 
Material	AC: AirCoral®	AC: AirCoral®
Absorption capacity*	5.47 m ²	5.47 m ²
Mounting	Wall mounting	Wall mounting
IP rating	IP40	IP40
Insulation class	I	I
Control gear	Electronic ballast	Dimmable constant current driver
Lamp type	TC-DEL 	LED 350 mA 
Lamp wattage	1 x 26W	1 x 6.5W
Luminous efficacy	-	810 lm - 3000K
Light distribution	-	Wide beam 120°
Fitting	G24q-3	-
Light colour	-	White 3000K White 2700K 4000K (on request)
Voltage connection	220-240V - 50/60Hz	220-240V - 50/60Hz
CRI	-	>90
Emergency	-	-
Energy efficiency class	A	A+
Note	Extra white frosted glass fixed with polycarbonate screws.	Extra white frosted glass fixed with polycarbonate screws. Trailing-edge and leading-edge dimming (20 - 100%).

* The absorption capacity per m³ calculated by the American organization TCNA (Tile Council of North America) is measured for an average room of 2.7 m in height and therefore expressed in m²



MASTER OPEN







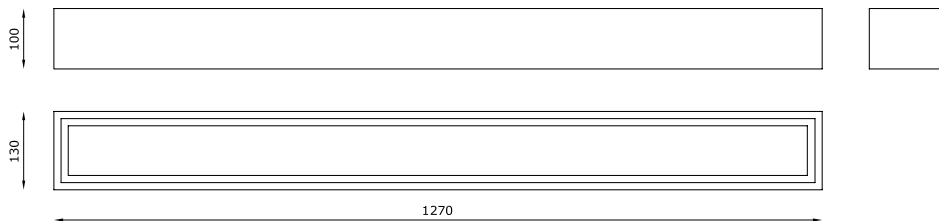
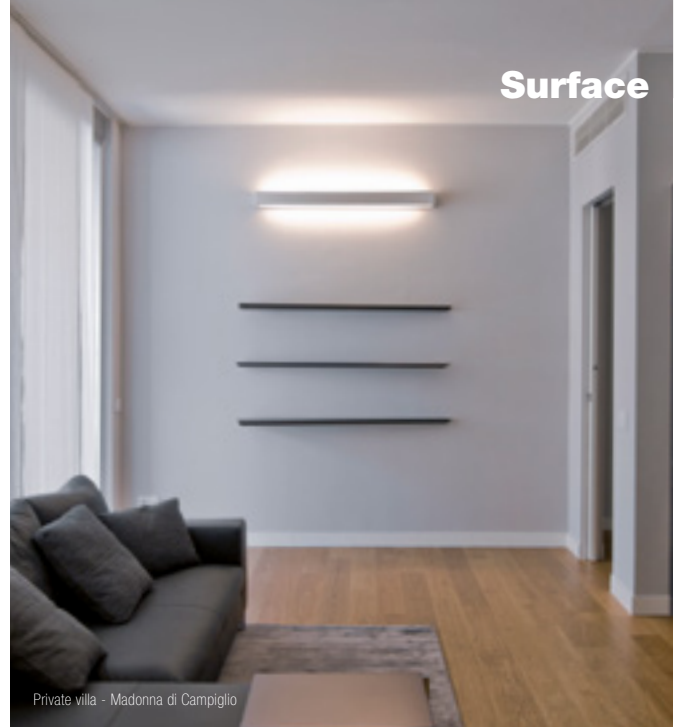





La luce incontra l'architettura e la valorizza grazie alla sua purezza: Master Open è una lampada a parete da interni che si inserisce sulle superfici con linearità ed eleganza. Il suo design minimale trasforma la luce in protagonista, creando una suggestione visiva dall'impatto deciso, regalando qualità allo spazio. Perfetta combinazione di tecnologia avanzata e funzionalità, Master Open è realizzato in AirCoral®.

Light meets architecture and enhances it thanks to its purity: Master Open is an indoor wall lamp that blends into surfaces with linearity and elegance. Its minimal design transforms light into a protagonist, creating a visual fascination with a decisive impact, donating quality to space. A perfect combination of advanced technology and functionality, Master Open is made of AirCoral®.



TECHNICAL FEATURES

Code	2954.AC	2955.P.AC	2956.AC	2958.AC	2953.AC
Type	Wall lamp 	Wall lamp 	Wall lamp 	Wall lamp 	Wall lamp 
Material	AC: AirCoral®	AC: AirCoral®	AC: AirCoral®	AC: AirCoral®	AC: AirCoral®
Absorption capacity*	22.72 m ²	22.72 m ²	22.72 m ²	22.72 m ²	22.72 m ²
Mounting	Wall mounting	Wall mounting	Wall mounting	Wall mounting	Wall mounting
IP rating	IP20	IP20	IP20	IP20	IP40
Insulation class	I	I	I	I	III
Control gear	Electronic ballast	Dimmable electronic ballast	Electronic ballast	Electronic ballast	Constant voltage LED driver
Lamp type	T5 (Ø 16 mm) 	T5 (Ø 16 mm) 	T5 (Ø 16 mm) 	T5 (Ø 16 mm) 	LED 24V 
Lamp wattage	1 x 54W	1 x 54W	1 x 54W	2 x 54W	2 x 21W
Luminous efficacy	-	-	-	-	2 x 2100 lm
Light distribution	-	-	-	-	Wide beam 120°
Fitting	G5	G5	G5	G5	-
Light colour	-	-	-	-	White 3000K White 2700K (on request)
Voltage connection	220-240V · 50/60Hz	220-240V · 50/60Hz	220-240V · 50/60Hz	220-240V · 50/60Hz	220-240V · 50/60Hz
CRI	-	-	-	-	>90
Emergency	-	-	1 hour	-	-
Energy efficiency class	A+	A+	A+	A+	A++
Note	-	Standard: dimmable switch dim. / push (on request: dimmable 1-10V or DALI).	-	-	-

OPTIONAL ACCESSORIES

product code	optional code	description	info
2954.AC / 2955.P.AC / 2956.AC 2958.AC / 2953.AC	2950	Glass safety screen	Protection IP40

* The absorption capacity per m² calculated by the American organization TCNA (Tile Council of North America) is measured for an average room of 2.7 m in height and therefore expressed in m²



PIPEDO OPEN





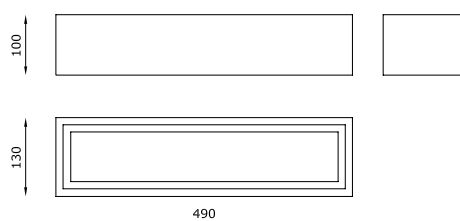

Pipedo Open è una lampada a parete da interni dal design pulito e lineare in grado di generare una luce generale d'ambiente, accogliente e allo stesso tempo non invasiva. Il prodotto stesso si trasforma in elemento d'arredo: l'apparecchio non si nasconde ma diventa protagonista arricchendo gli spazi. Pipedo Open è realizzato in AirCoral®, per garantire qualità e durata.

Pipedo Open is an indoor wall lamp with a clean and linear design, able to emit a general ambient light, welcoming yet non-invasive. The product becomes itself a piece of furniture: the luminaire is not hidden but becomes a protagonist, enhancing spaces. Pipedo Open is made of AirCoral®, to guarantee quality and duration.



TECHNICAL FEATURES

Code	2911.AC	2912.AC	2914.EB.AC	2915.P.AC	2916.AC
Type	Wall lamp 	Wall lamp 	Wall lamp 	Wall lamp 	Wall lamp 
Material	AC: AirCoral®	AC: AirCoral®	AC: AirCoral®	AC: AirCoral®	AC: AirCoral®
Absorption capacity*	10.09 m ²	10.09 m ²	10.09 m ²	10.09 m ²	10.09 m ²
Mounting	Wall mounting	Wall mounting	Wall mounting	Wall mounting	Wall mounting
IP rating	IP20	IP20	IP20	IP20	IP20
Insulation class	I	I	I	I	I
Control gear	-	-	Electronic ballast	Dimmable electronic ballast	Dimmable constant current driver
Lamp type	A 60 	QT-DE12 (75 mm) 	TC-L 	TC-L 	LED 350 mA 
Lamp wattage	1 x 100W max	1 x 150W max	1 x 36W	1 x 36W	2 x 8W
Luminous efficacy	-	-	-	-	2 x 1340 lm - 3000K
Light distribution	-	-	-	-	Wide beam 120°
Fitting	E27	R7s	2G11	2G11	-
Light colour	-	-	-	-	White 3000K White 2700K 4000K (on request)
Voltage connection	220-240V · 50/60Hz	220-240V · 50/60Hz	220-240V · 50/60Hz	220-240V · 50/60Hz	220-240V · 50/60Hz
CRI	-	-	-	-	>90
Emergency	-	-	-	-	-
Energy efficiency class	A ⁺	A	A	A	A ⁺
Note	-	-	-	Standard: dimmable switch dim. / push (on request: dimmable 1-10V or DALI).	Trailing-edge and leading-edge dimming (20 - 100%). Satin glass included.

OPTIONAL ACCESSORIES

product code	optional code	description	info
2914.EB.AC / 2915.P.AC	2910	Glass safety screen	Protection IP40

* The absorption capacity per m² calculated by the American organization TCNA (Tile Council of North America) is measured for an average room of 2.7 m in height and therefore expressed in m²

Pipedo Open



Private house - A. Castrignano - ph. F. Gambina - Milan



Private house - A. Castrignano - ph. F. Gambina - Milan



PIPEDINO OPEN







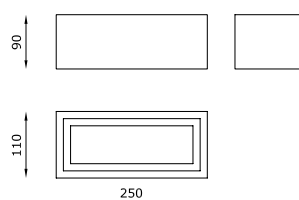



Pipedino Open è una lampada a parete da interni a biemissione in AirCoral® che genera una luce concreta, una guida omogenea attraverso le pareti. Una distribuzione luminosa diffusa, simmetrica e regolare; una luce diretta e indiretta. Le pareti, il soffitto, i complementi d'arredo vengono valorizzati in ogni dettaglio, grazie a una luce che regala qualità visiva.

Pipedino Open is an indoor bi-emission wall lamp made of AirCoral® that emanates a concrete light, a uniform guide throughout walls. A diffused light distribution, symmetrical and regular; a direct and indirect light. Walls, ceilings and furniture all get to be enhanced in detail, thanks to a light that gives visual quality.



TECHNICAL FEATURES

Code	2921.AC	2922.AC	2924.EB.AC	2926.AC
Type	Wall lamp 	Wall lamp 	Wall lamp 	Wall lamp 
Material	AC: AirCoral®	AC: AirCoral®	AC: AirCoral®	AC: AirCoral®
Absorption capacity*	5.09 m ²	5.09 m ²	5.09 m ²	5.09 m ²
Mounting	Wall mounting	Wall mounting	Wall mounting	Wall mounting
IP rating	IP20	IP20	IP20	IP20
Insulation class	I	I	I	I
Control gear	-	-	Electronic ballast	Dimmable constant current driver
Lamp type	A 60 	QT-DE12 (75 mm) 	TC-DEL 	LED 350 mA 
Lamp wattage	1 x 100W max	1 x 150W max	1 x 26W	2 x 6.5W
Luminous efficacy	-	-	-	2 x 810 lm - 3000K
Light distribution	-	-	-	Wide beam 120°
Fitting	E27	R7s	G24q-3	-
Light colour	-	-	-	White 3000K White 2700K 4000K (on request)
Voltage connection	220-240V · 50/60Hz	220-240V · 50/60Hz	220-240V · 50/60Hz	220-240V · 50/60Hz
CRI	-	-	-	>90
Emergency	-	-	-	-
Energy efficiency class	A+	A	A	A+
Note	-	-	-	Trailing-edge and leading-edge dimming (20 - 100%). Satin glass included.

OPTIONAL ACCESSORIES

product code	optional code	description	info
2924.EB.AC	2920	Glass safety screen	Protection IP40

* The absorption capacity per m² calculated by the American organization TCNA (Tile Council of North America) is measured for an average room of 2.7 m in height and therefore expressed in m²

Pipedino Open



Private villa - Arch. M. Marchesi



Private house - Arch. R. Ugolini



YANG



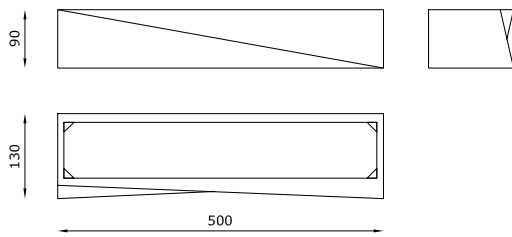

Yang è una lampada a parete da interni a biemissione in AirCoral® dalla forma sfaccettata. Intreccio di superfici inclinate che si intersecano, su cui la luce contribuisce a creare una contrapposizione di chiaro scuri. Yang diffonde nell'ambiente una luce accogliente e allo stesso tempo non invasiva.

Yang is a bi-emission indoor lamp made of AirCoral® and installable on walls. It has a multifaceted form, a twine of inclined surfaces crossing each other on which the emanated beam plays, creating a juxtaposition of light and shadow. Yang scatters a welcoming light which does not invade spaces, but embraces them.



TECHNICAL FEATURES

Code	2826.AC
Type	Wall lamp 
Material	AC: AirCoral®
Absorption capacity*	11.5 m ²
Mounting	Wall mounting
IP rating	IP20
Insulation class	I
Control gear	Dimmable constant current driver
Lamp type	LED 350 mA 
Lamp wattage	2 x 8W
Luminous efficacy	2 x 1340 lm - 3000K
Light distribution	Wide beam 120°
Fitting	-
Light colour	White 3000K White 2700K 4000K (on request)
Voltage connection	220-240V · 50/60Hz
CRI	>90
Emergency	-
Energy efficiency class	A ⁺
Note	Satin glass included. Trailing-edge and leading-edge dimming (20 - 100%).

* The absorption capacity per m³ calculated by the American organization TCNA (Tile Council of North America) is measured for an average room of 2.7 m in height and therefore expressed in m²



SUPERFUTUREDESIGN™





YIN



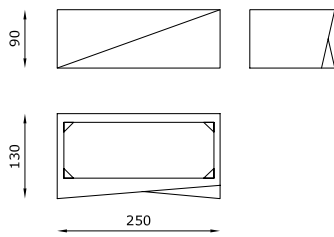

Yin, lampada a parete da interni a biemissione in AirCoral® dalla forma sfaccettata, genera una luminosità che si relaziona con lo spazio e il prodotto stesso. La luce emessa, infatti, crea una contrapposizione di luci e ombre sulla superficie del prodotto, la forma invece rompe la linearità delle pareti, imponendo la sua presenza in un modo originale.

Yin, a bi-emission indoor lamp of AirCoral® installable on walls, has a multifaceted form which creates a light capable of interacting with the space the product is placed in and with the product itself. The emanated beam, in fact, generates a juxtaposition of light and shadow on the surface of the luminaire, while the form breaks the walls linearity, imposing its presence in a very original way.



TECHNICAL FEATURES

Code	2816.AC
Type	Wall lamp 
Material	AC: AirCoral®
Absorption capacity*	5.5 m ²
Mounting	Wall mounting
IP rating	IP20
Insulation class	I
Control gear	Dimmable constant current driver
Lamp type	LED 350 mA 
Lamp wattage	2 x 6.5W
Luminous efficacy	2 x 810 lm - 3000K
Light distribution	Wide beam 120°
Fitting	-
Light colour	White 3000K White 2700K 4000K (on request)
Voltage connection	220-240V · 50/60Hz
CRI	>90
Emergency	-
Energy efficiency class	A+
Note	Satin glass included. Trailing-edge and leading-edge dimming (20 - 100%).

* The absorption capacity per m³ calculated by the American organization TCNA (Tile Council of North America) is measured for an average room of 2.7 m in height and therefore expressed in m²



SUPERFUTUREDESIGN™



LINEA 5



SISTEMA MODULARE TAGLIABILE A MISURA.

Linea 5 è un sistema modulare a parete da interni in AirCoral® con possibilità d'installazione in fila continua: una luce indiretta adatta ad ogni ambiente grazie alla possibilità di personalizzare la lunghezza dei moduli e tagliarli a 45° per ottenere angoli interni ed esterni. Un prodotto che permette di creare linee potenzialmente infinite, stabilendo regole sempre nuove all'interno della progettazione illuminotecnica: pulizia formale e luce pura per una soluzione elegante e discreta che si pone al servizio dei materiali e dei volumi, giocando un ruolo di primo piano nella definizione degli spazi. La particolare sovrapposizione delle sorgenti luminose evita qualsiasi cono d'ombra, per un effetto uniforme e suggestivo.

MODULAR SYSTEM WHICH CAN BE CUT TO MEASURE.

Linea 5 is an indoor wall system made of AirCoral®, installable in a continuous line: an indirect light perfect for any environment thanks to its linear modules that can be cut to the desired length and at 45° to get internal and external angles.



A product that can create endless light lines, establishing new rules inside illuminating engineering projects: formal purity and pure light for an elegant and discreet solution at the service of materials and volumes, playing a prominent role in the definition of spaces.

The peculiar overlapping of the light sources avoids any shadow cones, creating a uniform and suggestive effect.

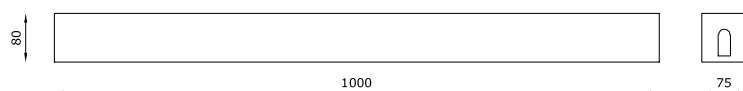
SINGLE MODULE CLOSED



TECHNICAL FEATURES | MODULAR BODY WITH LAMP

Code	9024.AC	9026.AC
Type	Wall lamp 	Wall lamp 
Material	AC: AirCoral®	AC: AirCoral®
Absorption capacity*	17.28 m ²	17.28 m ²
Mounting	Wall mounting	Wall mounting
IP rating	IP20	IP40
Insulation class	II	III
Control gear	-	-
Lamp type	T5 (lamp included) 	LED 24V 
Lamp wattage	1 x 21W	1 x 21W
Luminous efficacy	1850 lm	2100 lm
Light distribution	-	-
Fitting	G5	-
Light colour	White 2700K	White 3000K White 2700K (on request)
Voltage connection	220-240V · 50/60Hz	220-240V · 50/60Hz
CRI	-	-
Emergency	-	-
Energy efficiency class	A+	A++
Note	Single module closed and connected.	Single module closed and connected.

OPTIONAL ACCESSORIES

product code	optional code	description	info
9024.AC	9031	Polycarbonate safety screen	Protection IP40
9026.AC	9031	Polycarbonate safety screen	Protection IP40
	H8024.25	Constant voltage LED driver	Suitable for n°1 code 9026.AC - 24V

* The absorption capacity per m² calculated by the American organization TCNA (Tile Council of North America) is measured for an average room of 2.7 m in height and therefore expressed in m²

Linea 5

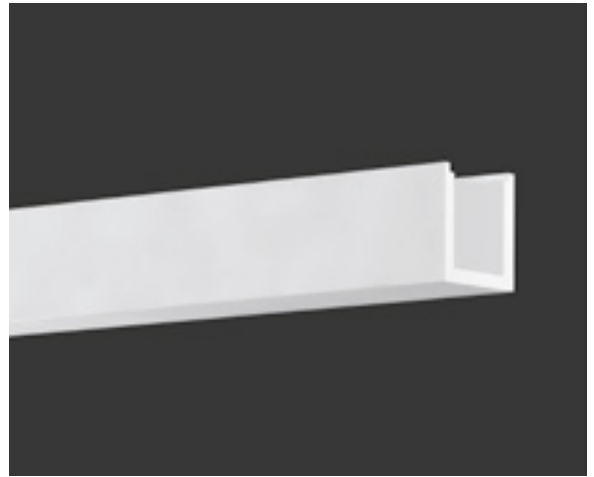
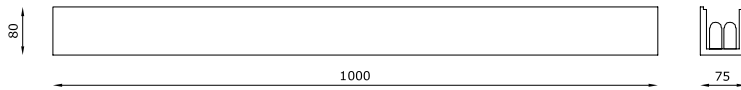

SINGLE MODULE OPEN



TECHNICAL FEATURES | MODULAR BODY WITHOUT LAMP

Code	9020.AC	9100.AC
Type	Wall lamp	Wall lamp
Material	AC: AirCoral®	AC: AirCoral®
Absorption capacity*	17.28 m ²	17.28 m ²
Mounting	Wall mounting	Wall mounting
IP rating	-	-
Note	Single module closed and empty. Lamp not included.	Single module open and empty. Lamp not included.

TECHNICAL FEATURES | LIGHT SOURCE

Code	8101	8102	8108
IP rating	IP20	IP20	IP40
Insulation class	II	II	III
Control gear	-	-	-
Lamp type	T5 (915 mm) 	T5 (1215 mm) 	LED 24V (900 mm) 
Lamp wattage	21W	28W	21W
Luminous efficacy	1850 lm	2470 lm	2100 lm
Light distribution	-	-	-
Fitting	G5	G5	-
Light colour	White 2700K	White 2700K	White 3000K White 2700K (on request)
Voltage connection	220-240V · 50/60Hz	220-240V · 50/60Hz	220-240V · 50/60Hz
CRI	-	-	-
Emergency	-	-	-
Energy efficiency class	A	A	A++
Note	Complete with alimentation cable and plug for the connection in series of several lamps.	Complete with alimentation cable and plug for the connection in series of several lamps.	-

OPTIONAL ACCESSORIES

product code	optional code	description	info
8108	H8024.25	Constant voltage LED driver	Suitable for n°1 code 8108 - 24V
9020.AC	9031	Polycarbonate safety screen	Protection IP40
9100.AC	9030	Polycarbonate safety screen	Protection IP40



EXAMPLE OF INSTALLATION

Note

Attention, for creating luminous continuity without shadow cones it is recommended to place on the electrical parts from a minimum of 80 mm to a maximum of 180 mm

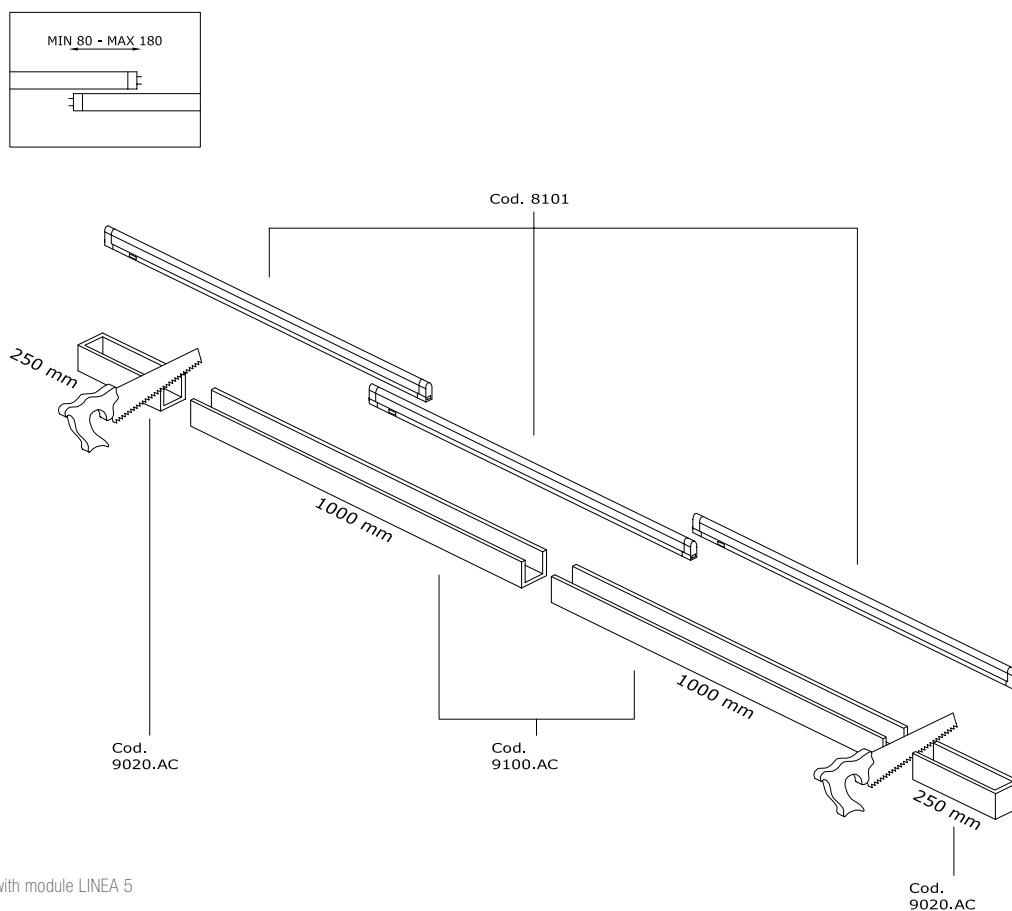

Example of application in continuous line with module LINEA 5 for 2500 mm:

- 2 pcs of empty modules code 9100.AC length 1000 mm each
- 2 pcs of lateral closing parts length 250 mm each; derives cutting the desired length of the module code 9020.AC (see drawing)

Example for applied connections:

- 3 pcs connections code 8101 Fluo T5 21W length 915 mm; placed on for 120 mm each



MODUS



Il modo perfetto per illuminare con stile ed eleganza un ambiente: Modus è una lampada a parete da interni in AirCoral® dal design lineare, che si integra nelle architetture arricchendole semplicemente con la sua presenza. Un design senza tempo che combina estetica e tecnologia ponendosi al servizio dei materiali e dei volumi.

The perfect way to light up a room with style and elegance: Modus is an indoor wall lamp made of AirCoral® with a linear design, that perfectly fits inside architectures, enhancing them just with its presence. A timeless design that combines aesthetics and technology at the service of materials and volumes.

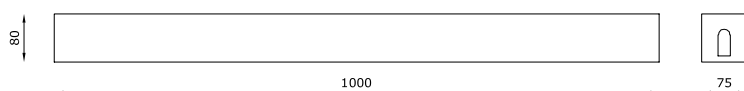

TECHNICAL FEATURES

Code	2944.AC	2946.AC
Type	Wall lamp	Wall lamp
Material	AC: AirCoral®	AC: AirCoral®
Absorption capacity*	17.28 m ²	17.28 m ²
Mounting	Wall mounting	Wall mounting
IP rating	IP20	IP40
Insulation class	II	III
Control gear	Electronic ballast	Constant voltage LED driver (not included)
Lamp type	T5 (lamp included) 	LED 24V 
Lamp wattage	1 x 21W	1 x 21W
Luminous efficacy	1850 lm	2100 lm
Light distribution	-	Wide beam 120°
Fitting	G5	-
Light colour	White 2700K	White 3000K White 2700K (on request)
Voltage connection	220-240V · 50/60Hz	220-240V · 50/60Hz
CRI	-	-
Emergency	-	-
Energy efficiency class	A+	A++
Note	-	-

OPTIONAL ACCESSORIES

product code	optional code	description	info
2944.AC	9031	Polycarbonate safety screen	Protection IP40
2946.AC	9031	Polycarbonate safety screen	Protection IP40
	H8024.25	Constant voltage LED driver	Suitable for n°1 code 2946.AC - 24V

* The absorption capacity per m² calculated by the American organization TCNA (Tile Council of North America) is measured for an average room of 2.7 m in height and therefore expressed in m²

Design

Peter Sencino



MAXIMAL



Maximal è una lampada a parete da interni in AirCoral® che parla la lingua del design. Essenziale nelle forme, può rispondere a tutte le esigenze. La luce diventa materia per definire gli spazi, giocando con gli arredi per creare accenti luminosi dal fascino unico. Un prodotto che si inserisce con originalità all'interno di qualsiasi progetto.

Maximal is an indoor wall lamp made of AirCoral® that speaks the language of design. Essential in its shape, it can answer to all the needs. Light becomes substance to define spaces, playing with furniture to create bright accents with a unique charm. A product that harmonizes with originality inside any project.

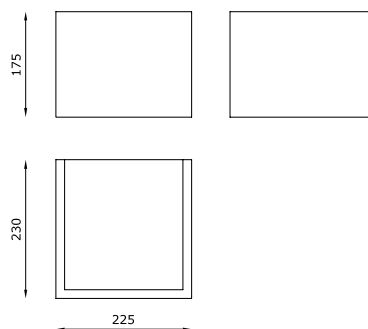

Private house - A. Castrignano - ph. R. Gasperoni - Milan

TECHNICAL FEATURES

Code	2713.AC	2718.AC
Type	Wall lamp ▼	Wall lamp ▼
Material	AC: AirCoral®	AC: AirCoral®
Absorption capacity*	12.29 m ²	12.29 m ²
Mounting	Wall mounting	Wall mounting
IP rating	IP40	IP20
Insulation class	I	I
Control gear	-	-
Lamp type	QT-DE12 ⇌	LED ⏏
Lamp wattage	1 x 200W max	1 x 18W
Luminous efficacy	-	1300 lm
Light distribution	-	Wide beam 120°
Fitting	R7s	-
Light colour	-	White 3000K
Voltage connection	220-240V - 50/60Hz	220-240V - 50/60Hz
CRI	-	-
Emergency	-	-
Energy efficiency class	A	A++
Note	-	Phase cutting dimmable (20 - 100%).

* The absorption capacity per m³ calculated by the American organization TCNA (Tile Council of North America) is measured for an average room of 2.7 m in height and therefore expressed in m²

Design

Peter Sencino



MINIMAL



Minimalista nello stile, altamente performante nella resa luminosa: Minimal è una lampada a parete da interni in AirCoral®, a luce indiretta che gioca con gli spazi costruiti, regalando loro corpo e volume.

Il prodotto si inserisce nelle pareti attraverso un design non invasivo: un gioco di equilibri tra linearità e fantasia, per un approccio progettuale innovativo e mai scontato.

Minimalist in its style, with a highly performing light output: Minimal is an indirect light wall lamp for indoor spaces made of AirCoral® that plays with architectures, giving them shape and volume.

The product is integrated inside surfaces thanks to a non-invasive design: a game of balance between linearity and creativity, for an innovative and never ordinary project approach.

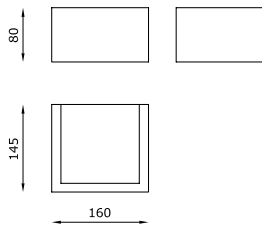

Private villa - Greece

TECHNICAL FEATURES

Code	2932.AC	2938.AC
Type	Wall lamp 	Wall lamp 
Material	AC: AirCoral®	AC: AirCoral®
Absorption capacity*	4.29 m ²	4.29 m ²
Mounting	Wall mounting	Wall mounting
IP rating	IP20	IP20
Insulation class	I	I
Control gear	-	-
Lamp type	QT-DE12 (75 mm) 	LED 
Lamp wattage	1 x 150W max	1 x 18W
Luminous efficacy	-	1300 lm
Light distribution	-	Wide beam 120°
Fitting	R7s	-
Light colour	-	White 3000K
Voltage connection	220-240V · 50/60Hz	220-240V · 50/60Hz
CRI	-	-
Emergency	-	-
Energy efficiency class	A	A++
Note	-	Phase cutting dimmable (20 - 100%).

* The absorption capacity per m³ calculated by the American organization TCNA (Tile Council of North America) is measured for an average room of 2.7 m in height and therefore expressed in m²

VERSUS





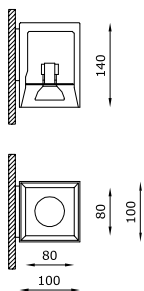

Emissione luminosa verso il basso o verso il soffitto: Versus è una lampada a parete da interni in AirCoral® versatile, in grado di adattarsi a seconda delle necessità e delle esigenze progettuali. Un prodotto dal design lineare, in cui la geometria è ispirazione e punto di partenza per rendere personale e inconfondibile ogni progetto di luce.

A downwards or upwards light emission: Versus is a versatile indoor wall lamp made of AirCoral® that allows infinite possibilities inside the light engineering project, depending on architectural needs and demands. A product with a linear design, where geometry is inspiration and a starting point to make every lighting project personal and unmistakable.



TECHNICAL FEATURES

Code	2191.AC	2192.AC
Type	Wall lamp 	Wall lamp 
Material	AC: AirCoral®	AC: AirCoral®
Absorption capacity*	4.21 m ²	4.21 m ²
Mounting	Wall mounting	Wall mounting
IP rating	IP20	IP20
Insulation class	I	I
Control gear	-	-
Lamp type	QPAR 16 	QPAR 16 
Lamp wattage	1 x 50W max	1 x 50W max
Luminous efficacy	-	-
Light distribution	-	-
Fitting	GU10	GU10
Light colour	-	-
Voltage connection	220-240V · 50/60Hz	220-240V · 50/60Hz
CRI	-	-
Emergency	-	-
Energy efficiency class	A	A
Note	Installation for direct light.	Installation for indirect light.

OPTIONAL ACCESSORIES

product code	optional code	description	info
2191.AC / 2192.AC	0009KIT	Kit LED dimmable	Bulb 6W · 220-240V

* The absorption capacity per m² calculated by the American organization TCNA (Tile Council of North America) is measured for an average room of 2.7 m in height and therefore expressed in m²

BAUTA ELLISSE







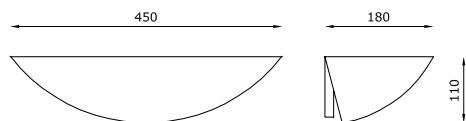



Perfetta combinazione di geometria e design, Bauta Ellisse è un lampada a parete da interni che si inserisce negli ambienti in modo discreto, integrandosi con il preciso obiettivo di esaltarne le peculiarità. Le curve delicate dell'apparecchio trasmettono eleganza, mentre le caratteristiche dell'AirCoral® — il materiale con cui Bauta Ellisse è realizzato — garantiscono qualità e resistenza: un prodotto versatile, in grado di fare la differenza all'interno degli ambienti in cui viene installato.

Perfectly combining geometry and design, Bauta Ellisse is an indoor wall lamp that discreetly fits inside rooms, integrating with the precise aim to highlight its distinctive features. The delicate curves of this luminaire convey elegance, while the characteristics of AirCoral® — the material Bauta Ellisse is made of — guarantee quality and resistance: a versatile product, able to make the difference inside the environments it is installed in.



TECHNICAL FEATURES

Code	7481.AC	7483.83.AC	7484.EB.AC	7488.AC
Type	Wall lamp 	Wall lamp 	Wall lamp 	Wall lamp 
Material	AC: AirCoral®	AC: AirCoral®	AC: AirCoral®	AC: AirCoral®
Absorption capacity*	10.34 m ²	10.34 m ²	10.34 m ²	10.34 m ²
Mounting	Wall mounting	Wall mounting	Wall mounting	Wall mounting
IP rating	IP20	IP40	IP20	IP40
Insulation class	I	I	I	I
Control gear	-	-	Electronic ballast	Dimmable constant current driver
Lamp type	A 60 	QT-DE12 	TC-TEL 	LED 350 mA 
Lamp wattage	1 x 100W max	1 x 200W max	1 x 26/32W	2 x 6.5W
Luminous efficacy	-	-	-	2 x 810 lm - 3000K
Light distribution	-	-	-	Wide beam 120°
Fitting	E27	R7s	Gx24q-3	-
Light colour	-	-	-	White 3000K White 2700K 4000K (on request)
Voltage connection	220-240V · 50/60Hz	220-240V · 50/60Hz	220-240V · 50/60Hz	220-240V · 50/60Hz
CRI	-	-	-	>90
Emergency	-	-	-	-
Energy efficiency class	A+	A	A	A+
Note	-	-	-	Satin glass included. Trailing-edge and leading-edge dimming (20 - 100%).

OPTIONAL ACCESSORIES

product code	optional code	description	info
7484.EB.AC	7480	Glass safety screen	Protection IP40

* The absorption capacity per m² calculated by the American organization TCNA (Tile Council of North America) is measured for an average room of 2,7 m in height and therefore expressed in m²

ELLISSE



La perfezione dell'ellisse si ispira alle geometrie e allo stesso tempo all'arte, concretizzando un prodotto dal design minimalista e moderno: Ellisse è una lampada a parete da interni in AirCoral® in cui la pulizia formale e la purezza della luce si fondono, in una combinazione unica.

Una luce indiretta che si diffonde sulle pareti, regalando atmosfere gradevoli e suggestive.







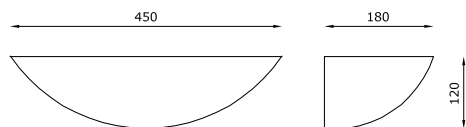

The perfection of the ellipse is inspired by geometry and art, creating a product with a minimal and modern design: Ellisse is an indoor wall lamp made of AirCoral® that combines purity of shape and of light, in a unique and refined mix.

An indirect light that spreads on walls, creating pleasant atmospheres.

A



TECHNICAL FEATURES | ELLISSE 450

Code	7421.AC (fig. A)	7423.23.AC (fig. A)	7424.EB.AC (fig. A)	7428.AC (fig. A)
Type	Wall lamp 	Wall lamp 	Wall lamp 	Wall lamp 
Material	AC: AirCoral®	AC: AirCoral®	AC: AirCoral®	AC: AirCoral®
Absorption capacity*	10.34 m ²	10.34 m ²	10.34 m ²	10.34 m ²
Mounting	Wall mounting	Wall mounting	Wall mounting	Wall mounting
IP rating	IP20	IP40	IP20	IP40
Insulation class	I	I	I	I
Control gear	-	-	Electronic ballast	Dimmable constant current driver
Lamp type	A 60 	QT-DE12 	TC-TEL 	LED 350 mA 
Lamp wattage	1 x 100W max	1 x 200W max	1 x 26/32W	1 x 6.5W
Luminous efficacy	-	-	-	810 lm - 3000K
Light distribution	-	-	-	Wide beam 120°
Fitting	E27	R7s	Gx24q-3	-
Light colour	-	-	-	White 3000K White 2700K 4000K (on request)
Voltage connection	220-240V · 50/60Hz	220-240V · 50/60Hz	220-240V · 50/60Hz	220-240V · 50/60Hz
CRI	-	-	-	>90
Emergency	-	-	-	-
Energy efficiency class	A+	A	A	A+
Note	-	-	-	Satin glass included. Trailing-edge and leading-edge dimming (20 - 100%).

OPTIONAL ACCESSORIES







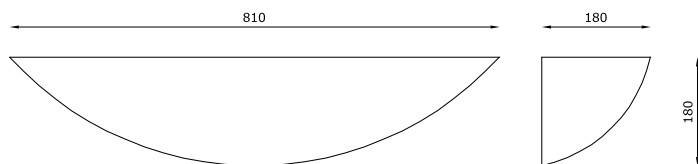



product code	optional code	description	info
7424.EB.AC	7480	Glass safety screen	Protection IP40

* The absorption capacity per m² calculated by the American organization TCNA (Tile Council of North America) is measured for an average room of 2.7 m in height and therefore expressed in m²

B









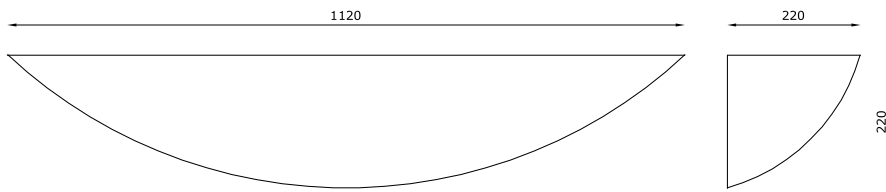

TECHNICAL FEATURES | ELLISSE 810

Code	7411.AC (fig. B)	7413.AC (fig. B)	7415.5.EB.AC (fig. B)	7445.AC (fig. B)	7448.AC (fig. B)
Type	Wall lamp 	Wall lamp 	Wall lamp 	Wall lamp 	Wall lamp 
Material	AC: AirCoral®	AC: AirCoral®	AC: AirCoral®	AC: AirCoral®	AC: AirCoral®
Absorption capacity*	22.26 m ²	22.26 m ²	22.26 m ²	22.26 m ²	22.26 m ²
Mounting	Wall mounting	Wall mounting	Wall mounting	Wall mounting	Wall mounting
IP rating	IP20	IP20	IP20	IP20	IP20
Insulation class	I	I	I	I	I
Control gear	-	-	Electronic ballast	Electronic ballast	Dimmable constant current driver
Lamp type	A 60 	QT-DE12 	TC-F 	TC-F 	LED 350 mA 
Lamp wattage	100W max	200W max	2 x 36W	36W	1 x 12.5W
Luminous efficacy	-	-	-	-	1 x 1620 lm - 3000K
Light distribution	-	-	-	-	Wide beam 120°
Fitting	E27	R7s	2G10	2G10	-
Light colour	-	-	-	-	White 3000K White 2700K 4000K (on request)
Voltage connection	220-240V · 50/60Hz	220-240V · 50/60Hz	220-240V · 50/60Hz	220-240V · 50/60Hz	220-240V · 50/60Hz
CRI	-	-	-	-	>80
Emergency	-	-	-	1 hour	-
Energy efficiency class	A ⁺	A ⁺	A	A	A ⁺
Note	-	-	-	-	Trailing-edge and leading-edge dimming (20 - 100%).

C



TECHNICAL FEATURES | ELLISSE 1120

	7403.3.AC (fig. C)	7405.5.AC (fig. C)	7435.AC (fig. C)	7438.AC (fig. C)
Code	7403.3.AC (fig. C)	7405.5.AC (fig. C)	7435.AC (fig. C)	7438.AC (fig. C)
Type	Wall lamp 	Wall lamp 	Wall lamp 	Wall lamp 
Material	AC: AirCoral®	AC: AirCoral®	AC: AirCoral®	AC: AirCoral®
Absorption capacity*	38.62 m ²	38.62 m ²	38.62 m ²	38.62 m ²
Mounting	Wall mounting	Wall mounting	Wall mounting	Wall mounting
IP rating	IP20	IP20	IP20	IP20
Insulation class	I	I	I	I
Control gear	-	Electronic ballast	Electronic ballast	Dimmable constant current driver
Lamp type	QT-DE12 	TC-F 	TC-F 	LED 350 mA 
Lamp wattage	2 x 200W max	2 x 36W	2 x 36W	2 x 12.5W
Luminous efficacy	-	-	-	2 x 1620 lm - 3000K
Light distribution	-	-	-	Wide beam 120°
Fitting	R7s	2G10	2G10	-
Light colour	-	-	-	White 3000K White 2700K 4000K (on request)
Voltage connection	220-240V · 50/60Hz	220-240V · 50/60Hz	220-240V · 50/60Hz	220-240V · 50/60Hz
CRI	-	-	-	>80
Emergency	-	-	1 hour	-
Energy efficiency class	A ⁺	A ⁺	A ⁺	A ⁺
Note	-	-	-	Trailing-edge and leading-edge dimming (20 - 100%).

* The absorption capacity per m³ calculated by the American organization TCNA (Tile Council of North America) is measured for an average room of 2.7 m in height and therefore expressed in m²



Private villa - Austria





ELLISSE BASE



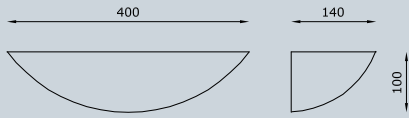

Una lampada a parete da interni in Coral® che fa della semplicità la sua caratteristica principale; Ellisse Base è la soluzione ideale per valorizzare gli ambienti attraverso una luce indiretta e delicata. Una tecnologia unica unita a un design senza tempo, un'estetica elegante e uniforme che si fonde armonicamente con lo spazio in cui il prodotto viene installato.

Simplicity is the main feature of this indoor wall lamp made of Coral®: Ellisse Base is the ideal solution to enhance spaces through an indirect and delicate light. A unique technology together with a timeless design, an elegant and uniform design harmonically combined with the space the product is installed in.



TECHNICAL FEATURES

Code	7442.00
Type	Wall lamp 
Material	00: Coral®
Weight	-
Mounting	Wall mounting
IP rating	IP20
Insulation class	I
Control gear	-
Cut out for plasterboard	-
Lamp type	QT-DE12 
Lamp wattage	1 x 150W max
Luminous efficacy	-
Light distribution	-
Fitting	R7s
Light colour	-
Light hole	-
Voltage connection	220-240V · 50/60Hz
CRI	-
Emergency	-
Energy efficiency class	A
Note	-

BAUTA SFERA







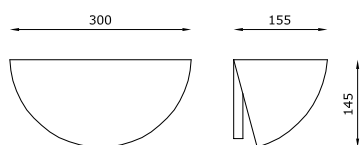



Bauta Sfera, una lampada a parete da interni, si impone con eleganza nello spazio costruito, una forma da cui si sprigiona una luce delicata. Le curve eleganti di Bauta Sfera si combinano alla qualità e alla resistenza del materiale AirCoral[®], dettando regole precise e soddisfacendo anche le esigenze progettuali minimaliste.

Bauta Sfera, an indoor wall lamp, elegantly imposes itself upon structured spaces, a shape emanating a delicate light. The elegant curves of Bauta Sfera combine with the quality and the resistance of AirCoral[®], satisfying even the most minimalist demands.



TECHNICAL FEATURES

Code	7081.AC	7083.83.AC	7084.EB.AC	7088.AC
Type	Wall lamp 	Wall lamp 	Wall lamp 	Wall lamp 
Material	AC: AirCoral®	AC: AirCoral®	AC: AirCoral®	AC: AirCoral®
Absorption capacity*	8.44 m ²	8.44 m ²	8.44 m ²	8.44 m ²
Mounting	Wall mounting	Wall mounting	Wall mounting	Wall mounting
IP rating	IP20	IP40	IP20	IP40
Insulation class	I	I	I	I
Control gear	-	-	Electronic ballast	Dimmable constant current driver
Lamp type	A 60 	QT-DE12 	TC-TEL 	LED 350 mA 
Lamp wattage	1 x 100W max	1 x 200W max	1 x 26/32W	2 x 6.5W
Luminous efficacy	-	-	-	2 x 810 lm - 3000K
Light distribution	-	-	-	Wide beam 120°
Fitting	E27	R7s	Gx24q-3	-
Light colour	-	-	-	White 3000K White 2700K 4000K (on request)
Voltage connection	220-240V · 50/60Hz	220-240V · 50/60Hz	220-240V · 50/60Hz	220-240V · 50/60Hz
CRI	-	-	-	>90
Emergency	-	-	-	-
Energy efficiency class	A+	A	A	A+
Note	-	-	-	Satin glass included. Trailing-edge and leading-edge dimming (20 - 100%).

OPTIONAL ACCESSORIES

product code	optional code	description	info
7084.EB.AC	7080	Glass safety screen	Protection IP40

* The absorption capacity per m³ calculated by the American organization TCNA (Tile Council of North America) is measured for an average room of 2,7 m in height and therefore expressed in m²



SFERA









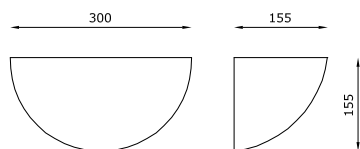

La forma geometrica per eccellenza dà vita a una lampada a parete da interni a luce indiretta in AirCoral® disponibile in 3 differenti misure. Il design delicato e sempre attuale: Sfera mantiene il giusto equilibrio tra funzione e bellezza delle forme, per un prodotto dalle performance illuminotecniche di qualità.

The geometric shape par excellence gives life to an indoor wall lamp made of AirCoral® available in three different versions. With a delicate and always modern design: Sfera keeps the right balance between functionality and beauty of shapes, for a product with high-quality illuminating engineering performances.

A



TECHNICAL FEATURES | SFERA 300

Code	7021.AC (fig. A)	7023.23.AC (fig. A)	7024.EB.AC (fig. A)	7028.AC (fig. A)
Type	Wall lamp 	Wall lamp 	Wall lamp 	Wall lamp 
Material	AC: AirCoral®	AC: AirCoral®	AC: AirCoral®	AC: AirCoral®
Absorption capacity*	7.22 m ²	7.22 m ²	7.22 m ²	7.22 m ²
Mounting	Wall mounting	Wall mounting	Wall mounting	Wall mounting
IP rating	IP20	IP40	IP20	IP40
Insulation class	I	I	I	I
Control gear	-	-	Electronic ballast	Dimmable constant current driver
Lamp type	A 60 	QT-DE12 	TC-TEL 	LED 350 mA 
Lamp wattage	1 x 100W max	1 x 200W max	1 x 26/32W	1 x 6.5W
Luminous efficacy	-	-	-	810 lm - 3000K
Light distribution	-	-	-	Wide beam 120°
Fitting	E27	R7s	Gx24q-3	-
Light colour	-	-	-	White 3000K White 2700K 4000K (on request)
Voltage connection	220-240V · 50/60Hz	220-240V · 50/60Hz	220-240V · 50/60Hz	220-240V · 50/60Hz
CRI	-	-	-	>90
Emergency	-	-	-	-
Energy efficiency class	A+	A	A	A+
Note	-	-	-	Satin glass included. Trailing-edge and leading-edge dimming (20 - 100%).

OPTIONAL ACCESSORIES



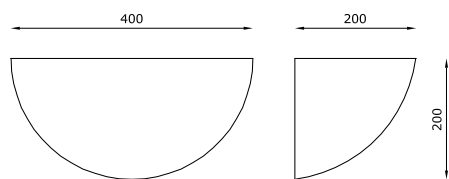

product code	optional code	description	info
7024.EB.AC	7080	Glass safety screen	Protection IP40

* The absorption capacity per m² calculated by the American organization TCNA (Tile Council of North America) is measured for an average room of 2.7 m in height and therefore expressed in m²

B









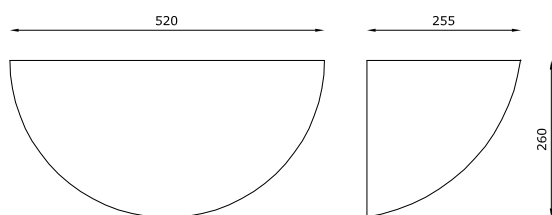

TECHNICAL FEATURES | SFERA 400

	7011.AC (fig. B)	7013.AC (fig. B)	7015.AC (fig. B)	7135.AC (fig. B)	7018.AC (fig. B)
Code	7011.AC (fig. B)	7013.AC (fig. B)	7015.AC (fig. B)	7135.AC (fig. B)	7018.AC (fig. B)
Type	Wall lamp 	Wall lamp 	Wall lamp 	Wall lamp 	Wall lamp 
Material	AC: AirCoral®	AC: AirCoral®	AC: AirCoral®	AC: AirCoral®	AC: AirCoral®
Absorption capacity*	13 m ²	13 m ²	13 m ²	13 m ²	13 m ²
Mounting	Wall mounting	Wall mounting	Wall mounting	Wall mounting	Wall mounting
IP rating	IP20	IP20	IP20	IP20	IP40
Insulation class	I	I	I	I	I
Control gear	-	-	Electronic ballast	Electronic ballast	Dimmable constant current driver
Lamp type	A 60 	QT-DE12 	TC-F 	TC-F 	LED 350 mA 
Lamp wattage	100W max	200W max	36W	36W	6.5W
Luminous efficacy	-	-	-	-	810 lm - 3000K
Light distribution	-	-	-	-	Wide beam 120°
Fitting	E27	R7s	2G10	2G10	-
Light colour	-	-	-	-	White 3000K White 2700K 4000K (on request)
Voltage connection	220-240V · 50/60Hz	220-240V · 50/60Hz	220-240V · 50/60Hz	220-240V · 50/60Hz	220-240V · 50/60Hz
CRI	-	-	-	-	>90
Emergency	-	-	-	1 hour	-
Energy efficiency class	A ⁺	A	A	A	A ⁺
Note	-	-	Satin glass included.	Satin glass included.	Satin glass included. Trailing-edge and leading-edge dimming (20 - 100%).

C



TECHNICAL FEATURES | SFERA 520

Code	7001.AC (fig. C)	7003.AC (fig. C)	7145.AC (fig. C)	7148.AC (fig. C)
Type	Wall lamp 	Wall lamp 	Wall lamp 	Wall lamp 
Material	AC: AirCoral®	AC: AirCoral®	AC: AirCoral®	AC: AirCoral®
Absorption capacity*	22.33 m ²	22.33 m ²	22.33 m ²	22.33 m ²
Mounting	Wall mounting	Wall mounting	Wall mounting	Wall mounting
IP rating	IP20	IP20	IP20	IP20
Insulation class	I	I	I	I
Control gear	-	-	Electronic ballast	Dimmable constant current driver
Lamp type	A 60 	QT-DE12 	TC-F 	LED 350 mA 
Lamp wattage	1 x 100W max	1 x 200W max	1 x 36W	2 x 6.5W
Luminous efficacy	-	-	-	2 x 810 lm - 3000K
Light distribution	-	-	-	Wide beam 120°
Fitting	E27	R7s	2G10	-
Light colour	-	-	-	White 3000K White 2700K 4000K (on request)
Voltage connection	220-240V · 50/60Hz	220-240V · 50/60Hz	220-240V · 50/60Hz	220-240V · 50/60Hz
CRI	-	-	-	>90
Emergency	-	-	1 hour	-
Energy efficiency class	A ⁺	A ⁺	A	A ⁺
Note	-	-	-	Satin glass included. Trailing-edge and leading-edge dimming (20 - 100%).

OPTIONAL ACCESSORIES

product code	optional code	description	info
7145.AC	7140	Glass safety screen	Protection IP40

* The absorption capacity per m³ calculated by the American organization TCNA (Tile Council of North America) is measured for an average room of 2.7 m in height and therefore expressed in m²

SFERA S 300







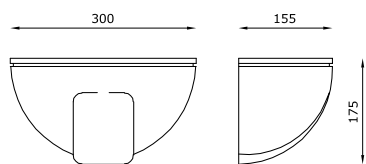

Sfera S 300, una lampada a parete da interni in AirCoral® che traduce in luce le idee creative del progettista. Questo prodotto si inserisce negli ambienti in modo mai scontato, diventando protagonista all'interno dell'ambiente da illuminare.

Sfera S 300, an indoor wall lamp made of AirCoral® that translates the creative ideas of the designer into light. This luminaire fits into spaces in a never ordinary way, becoming the protagonist inside the space to be lighted.



TECHNICAL FEATURES

Code	7121.AC	7122.AC	7124.EB.AC
Type	Wall lamp 	Wall lamp 	Wall lamp 
Material	AC: AirCoral®	AC: AirCoral®	AC: AirCoral®
Absorption capacity*	7.29 m ²	7.29 m ²	7.29 m ²
Mounting	Wall mounting	Wall mounting	Wall mounting
IP rating	IP20	IP20	IP20
Insulation class	I	I	I
Control gear	-	-	Electronic ballast
Lamp type	A 60 	QT-DE12 (75 mm) 	TC-TEL 
Lamp wattage	1 x 100W max	1 x 150W max	1 x 26/32W
Luminous efficacy	-	-	-
Light distribution	-	-	-
Fitting	E27	R7s	Gx24q-3
Light colour	-	-	-
Voltage connection	220-240V · 50/60Hz	220-240V · 50/60Hz	220-240V · 50/60Hz
CRI	-	-	-
Emergency	-	-	-
Energy efficiency class	A ⁺	A	A
Note	-	-	-

* The absorption capacity per m³ calculated by the American organization TCNA (Tile Council of North America) is measured for an average room of 2.7 m in height and therefore expressed in m²



SFERA BASE



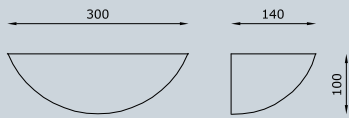

Una lampada a parete da interni in Coral[®] che fa della semplicità la sua caratteristica vincente: Sfera Base, grazie alle sue forme pure, si inserisce all'interno del progetto illuminotecnico garantendo qualità, efficienza e stile. La semplicità diventa l'essenza stessa del design.

An indoor wall lamp made of Coral[®] that makes of simplicity its winning feature: thanks to its pure shape, Sfera Base fits inside the illuminating engineering project guaranteeing quality, efficiency and style. Simplicity becomes the real essence of design.



TECHNICAL FEATURES

Code	7042.00
Type	Wall lamp 
Material	00: Coral®
Weight	-
Mounting	Wall mounting
IP rating	IP20
Insulation class	I
Control gear	-
Cut out for plasterboard	-
Lamp type	QT-DE12 
Lamp wattage	1 x 150W max
Luminous efficacy	-
Light distribution	-
Fitting	R7s
Light colour	-
Light hole	-
Voltage connection	220-240V · 50/60Hz
CRI	-
Emergency	-
Energy efficiency class	A
Note	-

CUPOLA





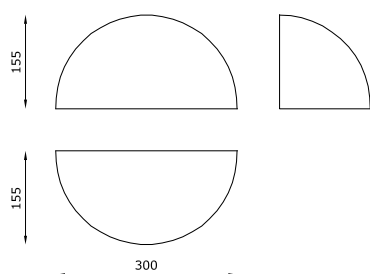

Una delle forme più usate in architettura e di ispirazione per la nascita di questa lampada a parete da interni in AirCoral®: Cupola è geometria, è eleganza, è semplicità e allo stesso tempo essenza di luce. Un'illuminazione diretta, concreta, in cui il design del prodotto è protagonista insieme alla luce.

One of the most used shapes in architecture and the inspiration for this indoor wall lamp made of AirCoral®: Cupola is geometry, elegance, simplicity, and at the same time it is essence of light. A direct and concrete illumination, a product whose design is the protagonist together with light.



TECHNICAL FEATURES

Code	7934.AC	7938.AC
Type	Wall lamp 	Wall lamp 
Material	AC: AirCoral®	AC: AirCoral®
Absorption capacity*	8.66 m ²	8.66 m ²
Mounting	Wall mounting	Wall mounting
IP rating	IP40	IP40
Insulation class	I	I
Control gear	Electronic ballast	Dimmable constant current driver
Lamp type	TC-DEL 	LED 350 mA 
Lamp wattage	1 x 26W	1 x 6.5W
Luminous efficacy	-	810 lm - 3000K
Light distribution	-	Wide beam 120°
Fitting	G24q-3	-
Light colour	-	White 3000K White 2700K 4000K (on request)
Voltage connection	220-240V · 50/60Hz	220-240V · 50/60Hz
CRI	-	>90
Emergency	-	-
Energy efficiency class	A	A+
Note	Satin glass included.	Satin glass included. Trailing-edge and leading-edge dimming (20 - 100%).

* The absorption capacity per m² calculated by the American organization TCNA (Tile Council of North America) is measured for an average room of 2.7 m in height and therefore expressed in m²

ANGOLO







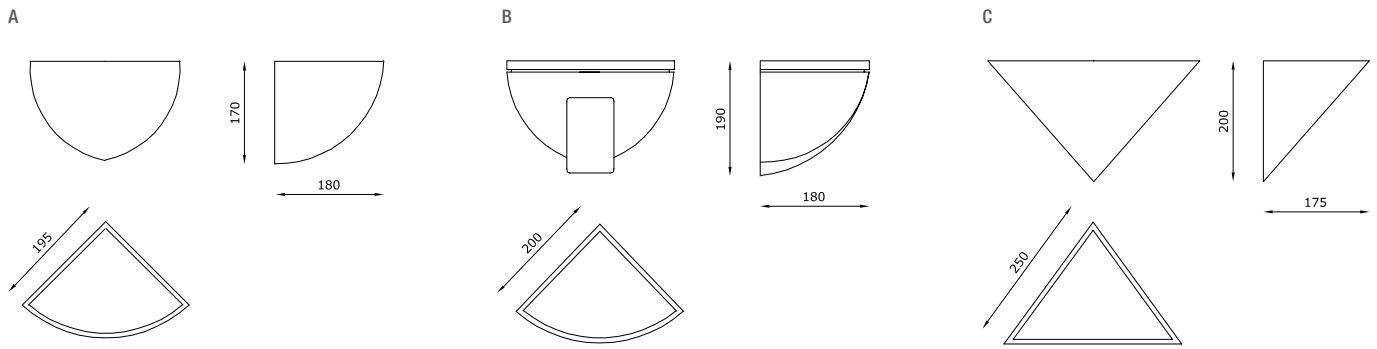

Angolo è una lampada a parete da interni in AirCoral® dal design pulito: disponibile in 3 diverse forme. Angolo si inserisce perfettamente nell'incrocio di due pareti ortogonali, dando vita a una luce indiretta che illumina gli ambienti in modo delicato e mai invasivo. Performance illuminotecniche uniche si fondono con un'attenzione per l'estetica e per i dettagli, in una perfetta combinazione di tecnologia avanzata ed eleganza.

Angolo is an indoor wall lamp made of AirCoral® with a clean design: available in 3 different shapes. Angolo perfectly fits inside the intersection of two orthogonal walls, giving life to an indirect light that illuminates the environment in a delicate and never invasive way. Unique illuminating engineering performances are blended with an attention to beauty and details, in a perfect combination of advanced technology and elegance.



TECHNICAL FEATURES

Code	7621.AC (fig. A)	7622.AC (fig. A)	7721.AC (fig. B)	7722.AC (fig. B)	7821.AC (fig. C)	7822.AC (fig. C)
Type	Wall lamp	Wall lamp	Wall lamp	Wall lamp	Wall lamp	Wall lamp
Material	AC: AirCoral®	AC: AirCoral®	AC: AirCoral®	AC: AirCoral®	AC: AirCoral®	AC: AirCoral®
Absorption capacity*	8.88 m ²	8.88 m ²	8.88 m ²	8.88 m ²	8.88 m ²	8.88 m ²
Mounting	Wall mounting	Wall mounting	Wall mounting	Wall mounting	Wall mounting	Wall mounting
IP rating	IP20	IP20	IP20	IP20	IP20	IP20
Insulation class	I	I	I	I	I	I
Control gear	-	-	-	-	-	-
Lamp type	D 45 	QT-DE12 (75 mm) 	D 45 	QT-DE12 (75 mm) 	D 45 	QT-DE12 (75 mm) 
Lamp wattage	1 x 60W max	1 x 150W max	1 x 60W max	1 x 150W max	1 x 60W max	1 x 150W max
Luminous efficacy	-	-	-	-	-	-
Light distribution	-	-	-	-	-	-
Fitting	E14	R7s	E14	R7s	E14	R7s
Light colour	-	-	-	-	-	-
Voltage connection	220-240V · 50/60Hz	220-240V · 50/60Hz	220-240V · 50/60Hz	220-240V · 50/60Hz	220-240V · 50/60Hz	220-240V · 50/60Hz
CRI	-	-	-	-	-	-
Emergency	-	-	-	-	-	-
Energy efficiency class	A ⁺	A	A ⁺	A	A ⁺	A
Note	-	-	-	-	-	-

* The absorption capacity per m² calculated by the American organization TCNA (Tile Council of North America) is measured for an average room of 2.7 m in height and therefore expressed in m²

Design

Alfredo Pollice

TORCE



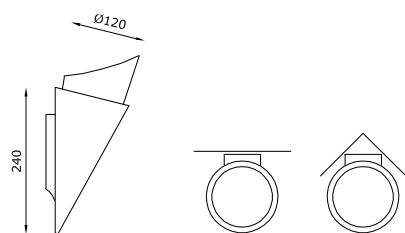

Un design originale e accattivante, una moderna torcia che illumina gli ambienti con eleganza: Torce è una lampada da interni in AirCoral® installabile sia a parete che ad angolo che interpreta in modo innovativo la necessità di illuminare.

An original and captivating design, a modern torch that lights up rooms with elegance: Torce is an indoor luminaire made of AirCoral®, installable either on walls or on corners, that interprets in an innovative way the need to illuminate.



Installable either on walls
or on corners

TECHNICAL FEATURES

Code	2021.AC
Type	Wall lamp 
Material	AC: AirCoral®
Absorption capacity*	5.02 m ²
Mounting	Wall mounting
IP rating	IP20
Insulation class	I
Control gear	-
Lamp type	A 60 
Lamp wattage	1 x 100W max
Luminous efficacy	-
Light distribution	-
Fitting	E27
Light colour	-
Voltage connection	220-240V · 50/60Hz
CRI	-
Emergency	-
Energy efficiency class	A ⁺
Note	Installable either on walls or on corners.

* The absorption capacity per m³ calculated by the American organization TCNA (Tile Council of North America) is measured for an average room of 2.7 m in height and therefore expressed in m²

Design

Ippolita Fraschini

FLAG







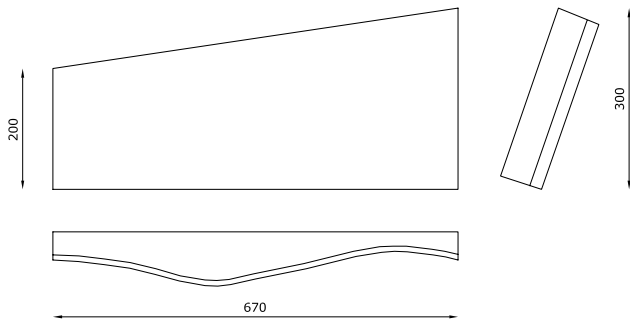

Un apparecchio che si staglia sulle pareti, flessibile e sinuoso: Flag è una lampada a parete da interni in AirCoral® predisposta sia per montaggio orizzontale che verticale, consentendo una massima flessibilità di utilizzo. Un prodotto in grado di fondersi con lo spazio circostante, generando una luce delicata e piacevole. Le finiture sono curate nel dettaglio: viti e giunture non sono visibili, per una superficie uniforme e incredibilmente resistente.

A luminaire that stands out on walls, flexible and sinuous: Flag is an indoor wall lamp made of AirCoral® that can be installed horizontally or vertically, allowing the highest flexibility of use. A product able to blend into the surrounding space, generating a delicate and pleasing light. Its finishings are made with attention to the smallest details: screws and joints are not visible, for a uniform and incredibly resistant surface.





TECHNICAL FEATURES

Code	1051.1.AC	1052.AC	1058.AC
Type	Wall lamp 	Wall lamp 	Wall lamp 
Material	AC: AirCoral®	AC: AirCoral®	AC: AirCoral®
Absorption capacity*	19.64 m ²	19.64 m ²	19.64 m ²
Mounting	Wall mounting	Wall mounting	Wall mounting
IP rating	IP20	IP20	IP20
Insulation class	I	I	I
Control gear	-	-	Dimmable constant current driver
Lamp type	A 60 	QT-DE12 (75 mm) 	LED 350 mA 
Lamp wattage	2 x 100W max	1 x 150W max	2 x 6.5W
Luminous efficacy	-	-	2 x 810 lm - 3000K
Light distribution	-	-	Wide beam 120°
Fitting	E27	R7s	-
Light colour	-	-	White 3000K White 2700K 4000K (on request)
Voltage connection	220-240V · 50/60Hz	220-240V · 50/60Hz	220-240V · 50/60Hz
CRI	-	-	>90
Emergency	-	-	-
Energy efficiency class	A+	A	A+
Note	Vertical and horizontal mounting.	Horizontal mounting.	Vertical and horizontal mounting. Trailing-edge and leading-edge dimming (20 - 100%).

* The absorption capacity per m² calculated by the American organization TCNA (Tile Council of North America) is measured for an average room of 2.7 m in height and therefore expressed in m²

Design

Lorenzo Stano



FRAME







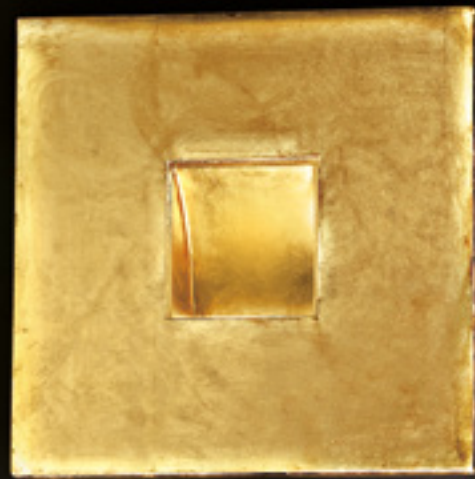
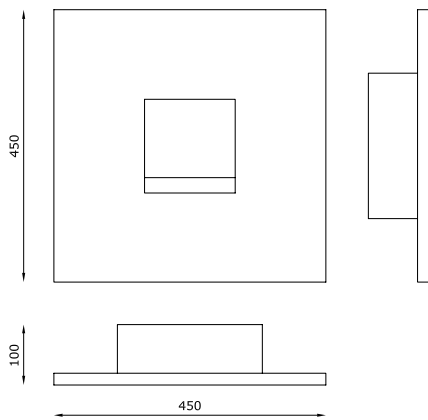



Una lampada a parete da interni con il corpo in AirCoral® trattabile con svariati tipi di finiture, tra cui "foglia oro". Una collaborazione tra Buzzi & Buzzi e l'Accademia di Brera Milano ha portato alla nascita di 12 "lucidipinte". Luce e arte si incontrano: 12 progetti iconografici interpretati dagli artisti dell'Accademia si fondono con la superficie neutra e la forma pura del Frame e, intimamente, con i suoi valori simbolici e strutturali, dando vita a vere e proprie opere d'arte "illuminate" da collocare all'interno dello spazio abitativo.

An indoor wall lamp with body in AirCoral® treatable with a variety of finishes, including "golden leaf". A collaboration between Buzzi & Buzzi and Milan's Brera Academy led to the creation of 12 "paintedlights". Light and art blend: 12 iconographic projects interpreted by artists of the Academy meet the neutral surface and the pure shape of Frame and, intimately, with its symbolic and structural values, giving life to real "illuminated" artworks to be placed inside the living space.



Example for gold leaf finish; code 2808.14









TECHNICAL FEATURES

Code	2802.AC	2804.AC	2805.PAC	2808.AC
Type	Wall lamp 	Wall lamp 	Wall lamp 	Wall lamp 
Material	AC: AirCoral®	AC: AirCoral®	AC: AirCoral®	AC: AirCoral®
Finishing	14: gold leaf (on request)	14: gold leaf (on request)	14: gold leaf (on request)	14: gold leaf (on request)
Absorption capacity*	21.23 m ²	21.23 m ²	21.23 m ²	21.23 m ²
Mounting	Wall mounting	Wall mounting	Wall mounting	Wall mounting
IP rating	IP20	IP20	IP20	IP20
Insulation class	I	I	I	I
Control gear	-	Electronic ballast	Dimmable electronic ballast	Dimmable constant current driver
Lamp type	QT-DE12 (75 mm) 	TC-DEL 	TC-DEL 	LED 350 mA 
Lamp wattage	1 x 150W max	1 x 26W	1 x 26W	1 x 6.5W
Luminous efficacy	-	-	-	810 lm - 3000K
Light distribution	-	-	-	Wide beam 120°
Fitting	R7s	G24q-3	G24q-3	-
Light colour	-	-	-	White 3000K White 2700K 4000K (on request)
Voltage connection	220-240V · 50/60Hz	220-240V · 50/60Hz	220-240V · 50/60Hz	220-240V · 50/60Hz
CRI	-	-	-	>90
Emergency	-	-	-	-
Energy efficiency class	A	A	A	A+
Note	-	-	Standard: dimmable switch dim. / push (on request: dimmable 1-10V or DALI).	Trailing-edge and leading-edge dimming (20 - 100%).

* The absorption capacity per m² calculated by the American organization TCNA (Tile Council of North America) is measured for an average room of 2.7 m in height and therefore expressed in m²



TECHNICAL FEATURES

	2804.ARTUSI	2804.JUNG	2804.MESKINI	2804.LONGONI
Code	2804.ARTUSI	2804.JUNG	2804.MESKINI	2804.LONGONI
Type	Wall lamp 	Wall lamp 	Wall lamp 	Wall lamp 
Finishing	Acrylic	Printed on plexiglass	Acrylic and steel	Printed picture
Absorption capacity*	-	-	-	-
Mounting	Wall mounting	Wall mounting	Wall mounting	Wall mounting
IP rating	IP20	IP20	IP20	IP20
Insulation class	I	I	I	I
Control gear	Electronic ballast	Electronic ballast	Electronic ballast	Electronic ballast
Lamp type	TC-DEL 	TC-DEL 	TC-DEL 	TC-DEL 
Lamp wattage	1 x 26W	1 x 26W	1 x 26W	1 x 26W
Luminous efficacy	-	-	-	-
Light distribution	-	-	-	-
Fitting	G24q-3	G24q-3	G24q-3	G24q-3
Light colour	-	-	-	-
Voltage connection	220-240V · 50/60Hz	220-240V · 50/60Hz	220-240V · 50/60Hz	220-240V · 50/60Hz
CRI	-	-	-	-
Emergency	-	-	-	-
Energy efficiency class	A	A	A	A
Note	-	-	-	-





TECHNICAL FEATURES

Code	2804.GIAGNACOVO	2804.BENVENUTO	2804.MARINONI	2804.FORLINI
Type	Wall lamp 	Wall lamp 	Wall lamp 	Wall lamp 
Finishing	Acrylic	Acrylic	Cotton, gold leaf	Acrylic
Absorption capacity*	-	-	-	-
Mounting	Wall mounting	Wall mounting	Wall mounting	Wall mounting
IP rating	IP20	IP20	IP20	IP20
Insulation class	I	I	I	I
Control gear	Electronic ballast	Electronic ballast	Electronic ballast	Electronic ballast
Lamp type	TC-DEL 	TC-DEL 	TC-DEL 	TC-DEL 
Lamp wattage	1 x 26W	1 x 26W	1 x 26W	1 x 26W
Luminous efficacy	-	-	-	-
Light distribution	-	-	-	-
Fitting	G24q-3	G24q-3	G24q-3	G24q-3
Light colour	-	-	-	-
Voltage connection	220-240V · 50/60Hz	220-240V · 50/60Hz	220-240V · 50/60Hz	220-240V · 50/60Hz
CRI	-	-	-	-
Emergency	-	-	-	-
Energy efficiency class	A	A	A	A
Note	-	-	-	-

Dodici "lucidipinte" si installano nel FAHB il nuovo grande albergo dell'Arte Contemporanea a Milano. Di prof. Andrea B. Del Guercio, titolare della Cattedra di Storia dell'Arte Contemporanea, Accademia di Belle Arti di Brera.

Pittura e scultura, nelle varie correnti artistiche caratterizzanti la storia dell'arte, dagli albori alla produzione in serie, sono sempre state in relazione con lo studio degli Interni, producendo un inestimabile patrimonio di opere che si fondono per creare un tutt'uno con lo spazio.

Da questo l'intuizione Buzzi & Buzzi di produrre dodici "lucidipinte", scelte tra oltre quaranta progetti iconografici, interpretate dagli artisti dell'Accademia di Brera, che sono ora esposte nell'Albergo FAHB. L'incipit di tale operazione creativa è la decisione di fondere il carattere espressivo dell'artista con la superficie neutra e la forma pura della linea "FRAME" e, più intimamente, con i suoi valori simbolici e strutturali.

La Luce nell'Arte ha sempre avuto un'importanza fondamentale, dalla ricerca scultorea del "Bello Ideale" Classico, all'idea degli Impressionisti di catturare l'attimo di luce che scorre e sfiora la materia. Nasce l'importanza del rapporto tra luce e materia e nel caso del concorso "Light-Parade" di Buzzi & Buzzi luce-energia che nasce dalla materia.

La luce ha una collocazione interna, creando una comunicazione con le decorazioni della cornice e generando così un'opera d'arte "illuminata" da collocare nello spazio abitativo.

Twelve "painted lights" are being installed at the FAHB, the new grand Hotel for Contemporary Art in Milan.

By Prof. Andrea B. Del Guercio, chairholder of History of Contemporary Art at the Brera Accademy of Fine Arts (Milan).

Painting and sculpture, in the different art trends characterizing art history, from dawn to the series production, have always been in relationship with the study of Indoors, producing an invaluable heritage of works that melt to create an all-in-one with the space.

From this the intuition of Buzzi & Buzzi to produce twelve "painted lights", chosen between more than forty iconographic projects interpreted from the artists of the Brera Accademy, which are now exposed in the FAHB Hotel. The incipit for this creative operation is the decision to merge the expressive character of the artist with the neutral surface and the pure shape of the "FRAME" line, more intimate, with its symbolic and structural values.

In art, Light has always been of fundamental importance, from the sculptural research of the classic "Ideal Beauty" to the idea of the Impressionists to capture the moment of light which flows and skims the materia. The importance of the relationship between light and materia appears and in the case of the "Light-Parade" contest from Buzzi & Buzzi light-energy arises from materia. The light has an internal placing, creating communication with the frame decoration and generating in this way an "illuminated" art work to place in the living space.



PONTE GRANDE



Un ponte al di sotto del quale scorre una luce che supera ogni barriera: Ponte Grande è una lampada a parete da interni dal design ricercato, per un'illuminazione dinamica e coinvolgente. La purezza del bianco e l'effetto setoso dell'AirCoral® caratterizzano un prodotto che si distingue per la sua eleganza, perfetta combinazione di estetica e tecnologia avanzata.

A bridge under which flows a light that goes beyond any barrier: Ponte Grande is an indoor wall lamp with a refined design, for a dynamic and engaging lighting. The purity of white and the silky effect of AirCoral® characterize a product that stands out for its elegance, a perfect combination of aesthetics and advanced technology.

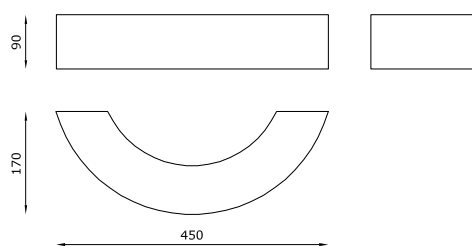

TECHNICAL FEATURES

Code	7901.AC	7902.AC	7905.AC	7908.AC
Type	Wall lamp 	Wall lamp 	Wall lamp 	Wall lamp 
Material	AC: AirCoral®	AC: AirCoral®	AC: AirCoral®	AC: AirCoral®
Absorption capacity*	8.2 m ²	8.2 m ²	8.2 m ²	8.2 m ²
Mounting	Wall mounting	Wall mounting	Wall mounting	Wall mounting
IP rating	IP20	IP20	IP20	IP20
Insulation class	I	I	I	I
Control gear	-	-	Electronic ballast	Dimmable constant current driver
Lamp type	A 60 	QT-DE12 (75 mm) 	TC-D/E 	LED 350 mA 
Lamp wattage	1 x 100W max	1 x 150W max	1 x 26W	1 x 6.5W
Luminous efficacy	-	-	-	810 lm - 3000K
Light distribution	-	-	-	Wide beam 120°
Fitting	E27	R7s	G24q-3	-
Light colour	-	-	-	White 3000K White 2700K 4000K (on request)
Voltage connection	220-240V · 50/60Hz	220-240V · 50/60Hz	220-240V · 50/60Hz	220-240V · 50/60Hz
CRI	-	-	-	>90
Emergency	-	-	-	-
Energy efficiency class	A+	A	A	A+
Note	-	-	-	Trailing-edge and leading-edge dimming (20 - 100%).

OPTIONAL ACCESSORIES

product code	optional code	description	info
7901.AC / 7902.AC / 7905.AC	7900	AirCoral® safety screen	

* The absorption capacity per m³ calculated by the American organization TCNA (Tile Council of North America) is measured for an average room of 2.7 m in height and therefore expressed in m²



PONTE PICCOLO



Le caratteristiche di Ponte Grande ma in versione ridotta: Ponte Piccolo è una lampada a parete da interni in AirCoral® che si pone al servizio dell'architettura. La luce diventa materia da plasmare, in grado di illuminare con raffinatezza gli spazi abitativi.

The same features of Ponte Grande but in a smaller version: Ponte Piccolo is an indoor wall lamp made of AirCoral® at the service of architecture. Light becomes a substance to be moulded, able to light living spaces up with refinement.

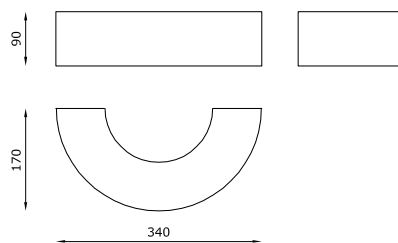

TECHNICAL FEATURES

Code	7921.AC	7922.AC
Type	Wall lamp 	Wall lamp 
Material	AC: AirCoral®	AC: AirCoral®
Absorption capacity*	6.67 m ²	6.67 m ²
Mounting	Wall mounting	Wall mounting
IP rating	IP20	IP20
Insulation class	I	I
Control gear	-	-
Lamp type	D 45 	QT-DE12 (75 mm) 
Lamp wattage	1 x 60W max	1 x 150W max
Luminous efficacy	-	-
Light distribution	-	-
Fitting	E14	R7s
Light colour	-	-
Voltage connection	220-240V · 50/60Hz	220-240V · 50/60Hz
CRI	-	-
Emergency	-	-
Energy efficiency class	A ⁺	A
Note	-	-

OPTIONAL ACCESSORIES

product code	optional code	description	info
7921.AC / 7922.AC	7920	AirCoral® safety screen	

* The absorption capacity per m² calculated by the American organization TCNA (Tile Council of North America) is measured for an average room of 2.7 m in height and therefore expressed in m²



LIGHT BOX



Un box da cui la luce si sprigiona con determinazione, creando effetti luminosi suggestivi: Light Box è un proiettore da interni da parete a luce diretta ed indiretta dotato di gruppo ottico asimmetrico ad alta resa in alluminio 99,85% protetto da un vetro di sicurezza. Il prodotto è dotato di un telaio portacomponenti in acciaio verniciato bianco sul quale sono presenti guide su cui viene posizionato il corpo in AirCoral®.







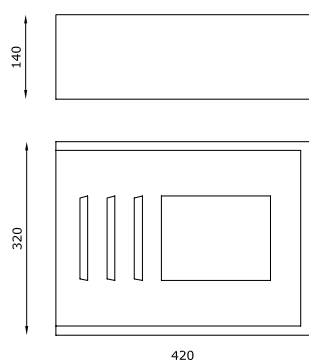



Light Box è ideale per l'illuminazione di ambienti quali uffici, saloni, banche, chiese e centri commerciali; valorizza gli spazi, accentua i dettagli architettonici e le strutture, per una massima flessibilità di utilizzo.

A box out of which light comes out with determination, creating evocative light effects: Light Box is a wall direct and indirect light projector with a asymmetrical reflector in aluminium 99.85%, high luminance, protected by a diffusing security glass. The product is provided with a stainless steel control gear plate, white painted, on which AirCoral® body is installed by guide rail.

Light Box is ideal to light up offices, halls, banks, churches and shopping centres; it enhances spaces, highlights architectural details and structures, for the highest flexibility of use.



TECHNICAL FEATURES

Code	2106.AC	2107.AC	2206.AC	2207.AC
Type	Wall lamp 	Wall lamp 	Wall lamp 	Wall lamp 
Material	AC: AirCoral®	AC: AirCoral®	AC: AirCoral®	AC: AirCoral®
Absorption capacity*	21.19 m ²	21.19 m ²	21.19 m ²	21.19 m ²
Mounting	Wall mounting	Wall mounting	Wall mounting	Wall mounting
IP rating	IP40	IP40	IP40	IP40
Insulation class	I	I	I	I
Control gear	-	-	-	-
Lamp type (indirect lighting)	HIT-DE 	HIT-DE 	HIT-DE 	HIT-DE 
Lamp wattage	1 x 70W	1 x 150W	1 x 70W	1 x 150W
Luminous efficacy	-	-	-	-
Light distribution	-	-	-	-
Fitting	Rx7s	Rx7s	Rx7s	Rx7s
Light colour	-	-	-	-
Lamp type (direct lighting)	-	-	TC-F 	TC-F 
Lamp wattage	-	-	36W	36W
Luminous efficacy	-	-	-	-
Light distribution	-	-	-	-
Fitting	-	-	2G10	2G10
Light colour	-	-	-	-
Voltage connection	220-240V · 50/60Hz	220-240V · 50/60Hz	220-240V · 50/60Hz	220-240V · 50/60Hz
CRI	-	-	-	-
Emergency	-	-	-	-
Energy efficiency class	A	A	A	A
Note	Floodlight with indirect lighting for metal Halide source.	Floodlight with indirect lighting for metal Halide source.	Floodlight for direct lighting with compact fluorescent lamp and for indirect lighting with metal Halide source.	Floodlight for direct lighting with compact fluorescent lamp and for indirect lighting with metal Halide source.

* The absorption capacity per m² calculated by the American organization TCNA (Tile Council of North America) is measured for an average room of 2.7 m in height and therefore expressed in m²







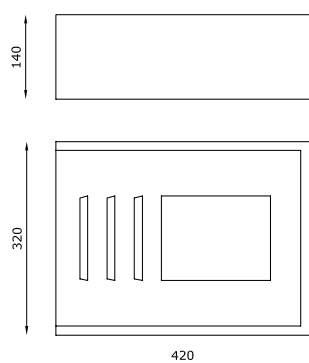



Light Box



Reception Prodit - Arch. Silvana Giovannini



TECHNICAL FEATURES

Code	2403.AC	2503.AC	2306.AC	2307.AC
Type	Wall lamp 	Wall lamp 	Wall lamp 	Wall lamp 
Material	AC: AirCoral®	AC: AirCoral®	AC: AirCoral®	AC: AirCoral®
Absorption capacity*	21.19 m ²	21.19 m ²	21.19 m ²	21.19 m ²
Mounting	Wall mounting	Wall mounting	Wall mounting	Wall mounting
IP rating	IP40	IP40	IP40	IP40
Insulation class	I	I	I	I
Control gear	-	-	-	-
Lamp type (indirect lighting)	QT-DE12 	QT-DE12 	HIT-DE 	HIT-DE 
Lamp wattage	1 x 300W	1 x 300W	1 x 70W	1 x 150W
Luminous efficacy	-	-	-	-
Light distribution	-	-	-	-
Fitting	R7s	R7s	Rx7s	Rx7s
Light colour	-	-	-	-
Lamp type (direct lighting)	TC-F 	-	TC-F 	TC-F 
Lamp wattage	1 x 36W	-	1 x 36W	1 x 36W
Luminous efficacy	-	-	-	-
Light distribution	-	-	-	-
Fitting	2G10	-	2G10	2G10
Light colour	-	-	-	-
Voltage connection	220-240V · 50/60Hz	220-240V · 50/60Hz	220-240V · 50/60Hz	220-240V · 50/60Hz
CRI	-	-	-	-
Emergency	-	-	1 hour	1 hour
Energy efficiency class	A	A	A	A
Note	Floodlight for direct lighting with compact fluorescent lamp and halogen lamp for indirect lighting.	Halogen indirect lighting floodlight.	Floodlight for direct lighting with compact fluorescent lamp predisposed for emergency. Indirect lighting with metal Halide source. Emergency kit for permanent lighting c/w inverter and NiCd battery for 1 hour minimum & control LED.	Floodlight for direct lighting with compact fluorescent lamp predisposed for emergency. Indirect lighting with metal Halide source. Emergency kit for permanent lighting c/w inverter and NiCd battery for 1 hour minimum & control LED.

* The absorption capacity per m² calculated by the American organization TCNA (Tile Council of North America) is measured for an average room of 2.7 m in height and therefore expressed in m²

CORNICE



Un sistema modulare a parete da interni in AirCoral® dal nome rappresentativo di una precisa caratteristica: Cornice è caratterizzato da modanature sporgenti, che richiamano gli ordini architettonici classici. Un nome, una forma, una funzione: questo prodotto, realizzato in 2 versioni — modulo singolo chiuso cablato con fluorescenza T8 (luce indiretta) e modulo singolo chiuso vuoto — è un vero e proprio elemento decorativo da inserire in parete, in grado di valorizzare gli ambienti e angolature grazie alla sua semplice presenza. I moduli lineari possono essere tagliati alla lunghezza richiesta e a 45° per ottenere gli angoli interni ed esterni.

A modular wall frame made of AirCoral® with a name that stands for a precise characteristic: Cornice is characterized by protruding moulding, that recall the classic architectural orders. A name, a shape, a function: this product, available in 2 versions — single closed module wired with T8 fluorescence (indirect light) and single closed empty module — is a decorative element stitched on the wall, able to enhance spaces and angles just with its presence. Linear modules can be cut to the desired length and at 45° to get internal and external angles.

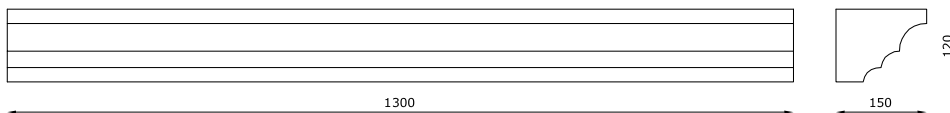

TECHNICAL FEATURES

	9005.AC	9000.AC
Code	9005.AC	9000.AC
Type	Wall lamp 	Wall lamp 
Material	AC: AirCoral®	AC: AirCoral®
Absorption capacity*	31.4 m ²	31.4 m ²
Mounting	Wall mounting	Wall mounting
IP rating	IP20	-
Insulation class	II	-
Control gear	Electronic ballast	-
Lamp type	T5 (lamp included) 	-
Lamp wattage	1 x 28W	-
Luminous efficacy	2470 lm	-
Light distribution	-	-
Fitting	G5	-
Light colour	2700K	-
Voltage connection	220-240V · 50/60Hz	-
CRI	-	-
Emergency	-	-
Energy efficiency class	A	-
Note	Upon request it can be cut on required dimensions. The internal and external angle are obtained by cutting the moduls at 45°.	Upon request it can be cut on required dimensions. The internal and external angle are obtained by cutting the moduls at 45°. Single module closed and empty.

* The absorption capacity per m³ calculated by the American organization TCNA (Tile Council of North America) is measured for an average room of 2.7 m in height and therefore expressed in m²



PIXEL C



1000 lm A PLAFONE IN 60 mm.

Apparecchio da interni per installazioni a soffitto in laterizio o cartongesso realizzato in AirCoral®, Pixel C si ispira alla famiglia Genius ed è caratterizzato da linee semplici e raffinate si integra perfettamente nelle superfici in cui viene installato. Lo spazio di installazione si riduce e anche il meccanismo si semplifica. La manutenzione della sorgente Led si effettua agevolmente attraverso il foro di emissione luce. Con un diametro di soli Ø 16 mm e un fascio puntuale e scenografico è in grado di creare giochi di luce d'effetto attraverso la sua semplicità tecnica.

1000 lm CEILING MOUNTED IN 60 mm.

Indoor luminaire made in AirCoral® for brick or plasterboard ceilings, Pixel C is inspired by the Genius family and is characterized by simple and refined lines, fits perfectly into the surfaces where it is installed. The installation space is reduced and the mechanism is also simplified. The LED source maintenance is easily carried out through the emission hole. With its only Ø 16 mm diameter and a punctual and scenographic beam, it's capable of creating impactful light effects through its technical simplicity.

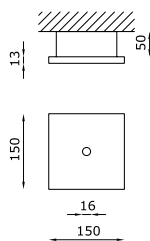

CODE COMPOSITION

1008.AC 4 S E WD

light colour

27	2700K
30	3000K
40	4000K

lens

15	15°
25	25°
45	45°

example of code composition

1008.AC 4 S **25** E **30** WD

TECHNICAL FEATURES

Code	1008.AC XX
Type	Ceiling lamp 
Material	AC: AirCoral®
Absorption capacity*	1.39 m ²
Weight	-
Mounting	Ceiling mounting
IP rating	IP40
Insulation class	III
Control gear	Remote constant current driver (not included)
Cut out for plasterboard	-
Lamp type	LED 700 mA ⚡ Vf: 11.5 VDC
Lamp wattage	1 x 8.5W
Luminous efficacy	1000 lm - 3000K
Light distribution	Narrow beam 15° Beam 25° 45° (on request)
Fitting	-
Light colour	White 3000K White 2700K 4000K (on request)
Light hole	Ø 16 mm
Voltage connection	By driver (optional)
CRI	90
Emergency	-
Energy efficiency class	A++
Note	On request AVAILABLE dimmable PUSH or DALI, remote installation.

OPTIONAL ACCESSORIES

product code	optional code	description	info
1008.AC	H8700.E	Constant current electronic driver. Remote installation	Suitable for n°1 or n°3 code 1008.AC - 700 mA

* The absorption capacity per m² calculated by the American organization TCNA (Tile Council of North America) is measured for an average room of 2.7 m in height and therefore expressed in m²



SUPERFUTUREDESIGN™

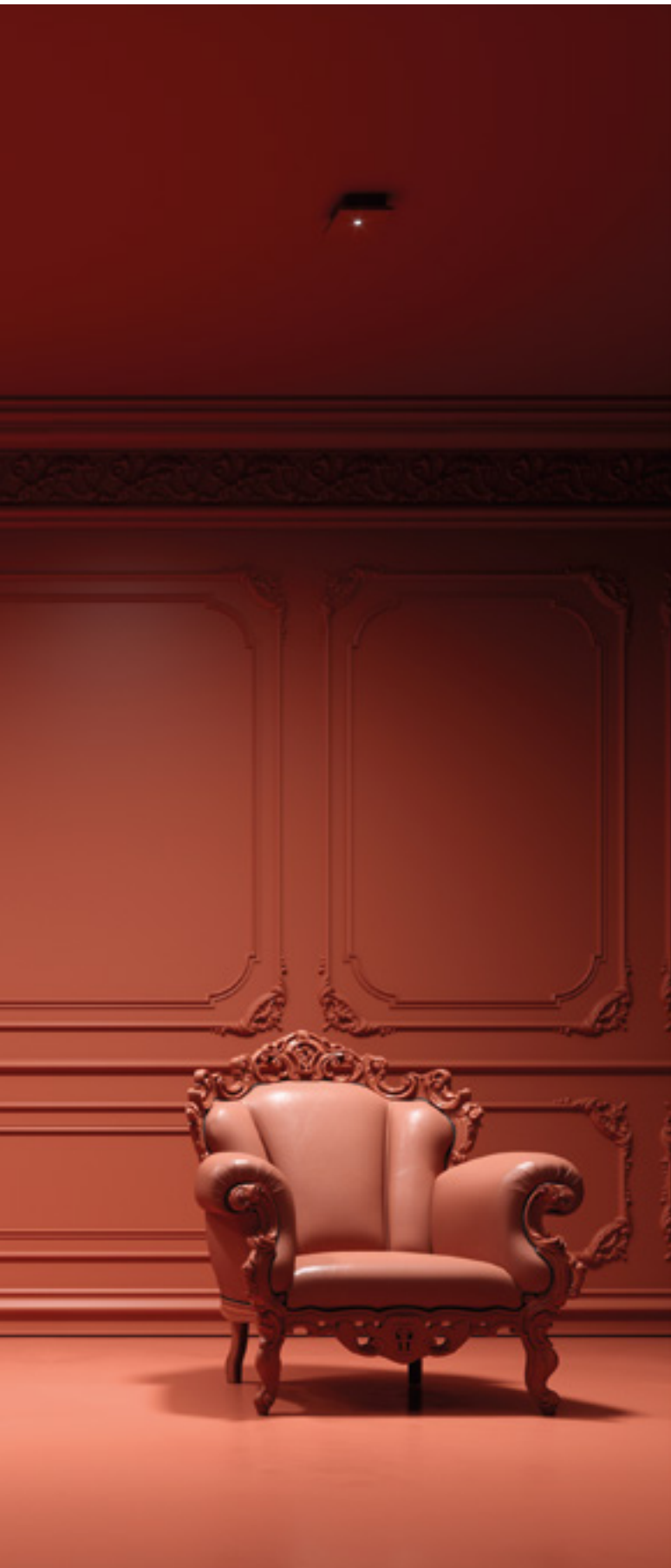



DOT



MINIATURIZZATO, ANTIABBAGLIANTE.

Dot, disponibile a 1, 3 o 5 sorgenti, è una lampada che contiene al suo interno una parabola rivoluzionaria che garantisce un effetto anti abbagliamento e sorgenti LED ad altissima intensità luminosa.

Si tratta di un apparecchio per interni in AirCoral® installabile a soffitto che sfrutta al massimo la ricerca tecnologica per garantire la più completa customizzazione della forma e dell'inclinazione della parabola interna. Sono disponibili diverse lenti che permettono di adattarsi ad ogni tipo di esigenza progettuale.

MINIATURISED, ANTI-GLARE.

Dot, available with 1, 3 or 5 light sources, is a lamp containing an innovative parabola which grants an antireflection effect and LED sources of high illumination intensity. It is an indoor luminaire made of AirCoral® and installable on ceilings which takes maximum advantage from technological research, guaranteeing the most complete customization of the form and inclination of the internal parabola. The product is available with different lens which allow the adaptation to any types of architectonic projects and necessities.

A. DOT 1

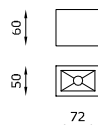



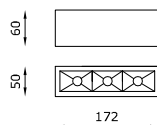

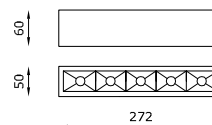

B. DOT 3



C. DOT 5



TECHNICAL FEATURES

Code	1911.AC (fig. A)	1913.AC (fig. B)	1915.AC (fig. C)
Type	Ceiling lamp 	Ceiling lamp 	Ceiling lamp 
Material	AC: AirCoral®	AC: AirCoral®	AC: AirCoral®
Absorption capacity*	0.88 m ²	2.20 m ²	3.52 m ²
Mounting	Ceiling mounting	Ceiling mounting	Ceiling mounting
IP rating	IP20	IP20	IP20
Insulation class	III	III	III
Control gear	Remote constant current electronic driver (not included)	Remote constant current electronic driver (not included)	Remote constant current electronic driver (not included)
Lamp type	LED 500 mA  Vf: 2.8 VDC	LED 500 mA  Vf: 3 x 2.8 VDC	LED 500 mA  Vf: 5 x 2.8 VDC
Lamp wattage	1 x 1.5W	3 x 1.5W	5 x 1.5W
Luminous efficacy	1 x 150 lm - 3000K	3 x 150 lm - 3000K	5 x 150 lm - 3000K
Light distribution	Narrow beam 15° Beam 30° (on request)	Narrow beam 15° Beam 30° (on request)	Narrow beam 15° Beam 30° (on request)
Fitting	-	-	-
Light colour	White 3000K White 2700K 4000K (on request)	White 3000K White 2700K 4000K (on request)	White 3000K White 2700K 4000K (on request)
Voltage connection	By driver (optional)	By driver (optional)	By driver (optional)
CRI	>90	>90	>90
Emergency	-	-	-
Energy efficiency class	A ⁺⁺	A ⁺⁺	A ⁺⁺
Note	-	-	-

OPTIONAL ACCESSORIES

product code	optional code	description	info
1911.AC	H8500.C	Constant current electronic driver. Remote installation	Suitable for n°3 code 1911.AC - 500 mA
1913.AC	H8500.C	Constant current electronic driver. Remote installation	Suitable for n°1 code 1913.AC - 500 mA
1915.AC	H8500.B	Constant current electronic driver. Remote installation	Suitable for n°1 code 1915.AC - 500 mA

* The absorption capacity per m² calculated by the American organization TCNA (Tile Council of North America) is measured for an average room of 2.7 m in height and therefore expressed in m²









SKY



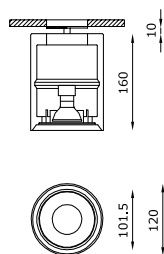

Sky, lampada a soffitto da interni in AirCoral® che emana un fascio di luce delicato e puntuale. Fornito di meccanica orientabile, la luce di Sky si sofferma sui dettagli che si desidera enfatizzare. Un'illuminazione in grado di cambiare l'equilibrio di uno spazio.

Sky, indoor ceiling luminaire made of AirCoral® that emits a delicate and precise beam of light. Supplied with an adjustable mechanical part, the light of Sky lingers on the details that have to be emphasized. A light able to change the balance of a living environment.



TECHNICAL FEATURES

Code	3042.AC	3048.Z.AC
Type	Tilttable ceiling lamp $\pm 30^\circ$ 	Tilttable ceiling lamp $\pm 30^\circ$ 
Material	AC: AirCoral®	AC: AirCoral®
Absorption capacity*	4.82 m ²	4.82 m ²
Mounting	Ceiling mounting	Ceiling mounting
IP rating	IP20	IP20
Insulation class	I	I
Control gear	-	Constant current electronic driver (not included)
Lamp type	QPAR 16 	LED 500 mA  Vf: 18 VDC
Lamp wattage	1 x 35W max	1 x 9W
Luminous efficacy	-	1125 lm - 3000K
Light distribution	-	Wide beam 40°
Fitting	GU10	-
Light colour	-	White 3000K White 2700K 4000K (on request)
Voltage connection	220-240V · 50/60Hz	By driver (optional)
CRI	-	>90
Emergency	-	-
Energy efficiency class	A	A++
Note	-	On request available dimmable PUSH or DALI, remote installation.

OPTIONAL ACCESSORIES

product code	optional code	description	info
3042.AC	0009KIT	Kit LED dimmable	Bulb 6W · 220-240V
3048.Z.AC	H8500.E	Constant current electronic driver. Remote installation	Suitable for n°2 code 3048.Z.AC - 500 mA
	H8500.B	Constant current electronic driver. Remote installation	Suitable for n°1 code 3048.Z.AC - 500 mA

* The absorption capacity per m² calculated by the American organization TCNA (Tile Council of North America) is measured for an average room of 2.7 m in height and therefore expressed in m²





STAR



L'illuminazione diventa strumento per dare vita agli spazi: Star è una lampada a soffitto da interni in AirCoral®, un prodotto originale, una luce d'accento che rende vivi i particolari con potenza e qualità: design ed efficienza, per una soluzione dal fascino unico.

Lighting becomes the tool that gives life to spaces: Star is an indoor ceiling luminaire made of AirCoral®, an original product, an accent light that brings details alive with power and quality: design and efficiency, for a solution with a unique charm.

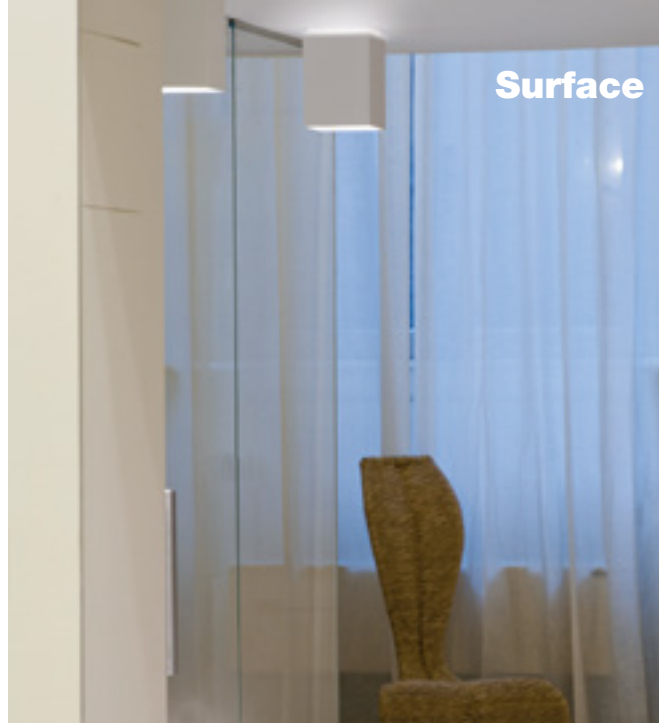
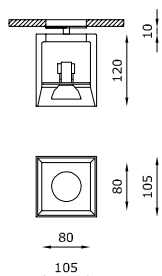

TECHNICAL FEATURES

Code	3032.AC
Type	Ceiling lamp 90° ▲
Material	AC: AirCoral®
Absorption capacity*	3.5 m ²
Mounting	Ceiling mounting
IP rating	IP20
Insulation class	I
Control gear	-
Lamp type	QPAR 16 ⚡
Lamp wattage	1 x 35W max
Luminous efficacy	-
Light distribution	-
Fitting	GU10
Light colour	-
Voltage connection	220-240V · 50/60Hz
CRI	-
Emergency	-
Energy efficiency class	A
Note	-

OPTIONAL ACCESSORIES

<i>product code</i>	<i>optional code</i>	<i>description</i>	<i>info</i>
3032.AC	0009KIT	Kit LED dimmable	Bulb 6W · 220-240V

* The absorption capacity per m² calculated by the American organization TCNA (Tile Council of North America) is measured for an average room of 2.7 m in height and therefore expressed in m²



SLICE C



800 lm A PLAFONE,
CON DRIVER INCORPORATO IN SOLI 60 mm.

Slice C è un apparecchio installabile a soffitto che si caratterizza per il design minimale.

Con un corpo a base quadrata di 150 x 150 mm e un'altezza totale di soli 60 mm permette installazioni su qualsiasi tipo di supporto. Realizzato con un corpo in alluminio verniciato bianco e frontalino in AirCoral® mantiene tutte le caratteristiche della sua versione a scomparsa totale. L'ottica LED è in grado di emettere 800 lumen e permette una manutenzione semplificata grazie alla rimozione e sostituzione della parte elettrica dal solo lato frontale, riducendo al minimo interventi post installazione. A differenza della sua versione ad incasso, Slice C permette di installare il driver on board.

800 lm CEILING MOUNTED
WITH INCORPORATED DRIVER IN JUST 60 mm.

Slice C is a ceiling-mounted luminaire with a minimal design. With a square base body measuring 150 x 150 mm and an only 60 mm total height, it can be installed on any type of support. Made with a white painted aluminium body and an AirCoral® front panel, it maintains all the features of its totally disappearing version. The LED optic is able to emit 800 lumens and allows a simplified maintenance thanks to the extraction and replacing of the electrical part from the front side only, reducing the post-installation maintenance to the minimum. Differently from its recessed version, Slice C allows to install the driver on board.

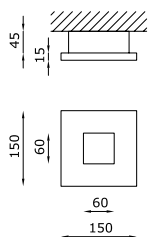

CODE COMPOSITION



1922.AC 4 S 00 E _ ND

light colour

27	2700K
30	3000K
40	4000K

example of code composition 1922.AC 4 S 00 E **30** ND

TECHNICAL FEATURES

Code	1922 XX
Type	Ceiling lamp 
Material	AC: AirCoral®
Absorption capacity*	1.20 m ²
Weight	-
Mounting	Ceiling mounting
IP rating	IP40
Insulation class	III
Control gear	Constant current electronic driver on board
Cut out for plasterboard	-
Lamp type	LED 300 mA 
Lamp wattage	1 x 7W
Luminous efficacy	800 lm - 3000K
Light distribution	Diffuse
Fitting	-
Light colour	White 3000K White 2700K 4000K (on request)
Light hole	60 x 60 mm
Voltage connection	220-240V · 50/60Hz
CRI	90
Emergency	-
Energy efficiency class	A ⁺⁺
Note	-

* The absorption capacity per m³ calculated by the American organization TCNA (Tile Council of North America) is measured for an average room of 2.7 m in height and therefore expressed in m²

Slice C



SUPERFUTUREDESIGN™



SIDUS



Sidus è una lampada a soffitto da interni in AirCoral® che descrive un nuovo percorso all'interno degli spazi architettonici. Una luce diffusa e omogenea, che arreda semplicemente con la sua presenza, sottolineando con semplicità i dettagli dello spazio.

Sidus is an indoor wall lamp made of AirCoral® that traces a new path inside architectural spaces. A scattered and consistent light that decorates simply with its presence, highlighting with simplicity the details of the space.

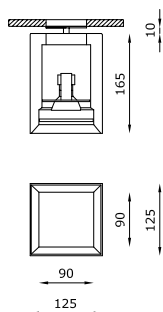

TECHNICAL FEATURES

Code	3028.Z.AC	3022.AC
Type	Ceiling lamp 90° 	Ceiling lamp 90°
Material	AC: AirCoral®	AC: AirCoral®
Absorption capacity*	4.87 m ²	4.87 m ²
Mounting	Ceiling mounting	Ceiling mounting
IP rating	IP20	IP20
Insulation class	I	I
Control gear	Constant current electronic driver (not included)	-
Lamp type	LED 500 mA Vf: 18 VDC	QPAR 16
Lamp wattage	1 x 9W	1 x 35W max
Luminous efficacy	1125 lm - 3000K	-
Light distribution	Wide beam 40°	-
Fitting	-	GU10
Light colour	White 3000K White 2700K 4000K (on request)	-
Voltage connection	By driver (optional)	220-240V · 50/60Hz
CRI	>90	-
Emergency	-	-
Energy efficiency class	A++	A
Note	Extra white satin glass. Recessed glass 30 mm. On request available dimmable PUSH or DALI, remote installation.	Extra white satin glass. Recessed glass 30 mm.

OPTIONAL ACCESSORIES

product code	optional code	description	info
3028.Z.AC	H8500.E	Constant current electronic driver. Remote installation	Suitable for n°2 code 3028.Z.AC - 500 mA
	H8500.B	Constant current electronic driver. Remote installation	Suitable for n°1 code 3028.Z.AC - 500 mA
3022.AC	0009KIT	Kit LED dimmable	Bulb 6W · 220-240V

* The absorption capacity per m² calculated by the American organization TCNA (Tile Council of North America) is measured for an average room of 2.7 m in height and therefore expressed in m²







BARD



INCASSO IN BATTUTA
COMPLETAMENTE VERNICIABILE COME IL SOFFITTO.

Bard è un apparecchio da incasso per installazione in battuta su soffitti di cartongesso, è dotato di corpo in Coral® e una meccanica composta da molle che permettono di fissarlo al controsoffitto. Con un corpo esterno a base quadrata di 100 x 100mm e un'anima interna metallica che, effettuando un foro di Ø 85 mm, permette installazioni su qualsiasi tipo di supporto. Bard è un apparecchio da interni dal design minimale e disponibile con diverse sorgenti luminose LED.

RECESSED TILL END POSITION
COMPLETELY PAINTABLE LIKE THE CEILING.

Bard is a recessed luminaire installable on plasterboard ceilings, equipped with a Coral® body and a spring mechanism that allows the product to be fixed to the false ceiling. Square base outer body measuring 100 x 100mm and inner metal core which, installed inside a Ø 85 mm hole, can be installed on any type of support. Bard is an indoor luminaire with a minimal design, available with different LED luminous sources.

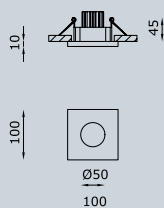

CODE COMPOSITION

1005.00 6 R 00 E 00 WD

1006.00 6 R 00 E 00 WD

TECHNICAL FEATURES

Code	1005.00 XX	1006.00 XX
Type	Downlight 90° 	Downlight 90° 
Material	00: Coral®	00: Coral®
Weight	0.7 Kg	0.7 Kg
Mounting	Ceiling recessed	Ceiling recessed
IP rating	IP20	IP20
Insulation class	III	I
Control gear	Electronic transformer (not included)	-
Cut out for plasterboard	Ø 85 mm	Ø 85 mm
Lamp type	QR CB 51 LED (optional) 	QPAR 16 LED (optional) 
Lamp wattage	-	-
Luminous efficacy	-	-
Light distribution	-	-
Fitting	GU5.3	GU10
Light colour	-	-
Light hole	Ø 50 mm	Ø 50 mm
Voltage connection	By driver (optional)	220-240V · 50/60Hz
CRI	-	-
Emergency	-	-
Energy efficiency class	A	A
Note	-	-

OPTIONAL ACCESSORIES

product code	optional code	description	info
1005.00 XX	H8060.LED	Dimmable electronic transformer	Max watt 60W Volts · Hz 230/12V · 50/60Hz
	0008KIT	Kit LED dimmable	Bulb 7W · 12V
1006.00 XX	0009KIT	Kit LED dimmable	Bulb 6W · 220-240V



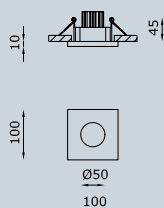

CODE COMPOSITION



1004.00 4 R 40 E _ WD

light colour

27	2700K
30	3000K
40	4000K

example of code composition 1004.00 4 R 40 E **30** WD

TECHNICAL FEATURES

Code	1004.00 XX
Type	Downlight 90° 
Material	00: Coral®
Weight	0.8 Kg
Mounting	Ceiling recessed
IP rating	IP20
Insulation class	III
Control gear	Constant current electronic driver (not included)
Cut out for plasterboard	Ø 85 mm
Lamp type	LED 500 mA  Vf: 18 VDC
Lamp wattage	1 x 9W
Luminous efficacy	1125 lm - 3000K
Light distribution	Wide beam 40°
Fitting	-
Light colour	White 3000K White 2700K 4000K (on request)
Light hole	Ø 50 mm
Voltage connection	By driver (optional)
CRI	90
Emergency	-
Energy efficiency class	A++
Note	On request available dimmable PUSH or DALI.

OPTIONAL ACCESSORIES

<i>product code</i>	<i>optional code</i>	<i>description</i>	<i>info</i>
1004.00 XX	H8500.E	Constant current electronic driver. Remote installation	Suitable for n°2 code 1004.00 XX - 500 mA
	H8500.B	Constant current electronic driver	Suitable for n°1 code 1004.00 XX - 500 mA



TELESCOPIC



Una serie di faretti a incasso da interni per installazione in soffitto di cartongesso. Telescopic si compone di una parte fissa e di una telescopica che consente di alloggiare la lampadina a filo esterno del faretto o all'interno, a seconda dell'effetto che si vuole creare, per soluzioni sempre diverse e particolari.

Telescopic è dotato di una parte in Coral®, disponibile in diverse forme, e di una meccanica cromata dotata di una parte fissa e una mobile che permette l'alloggiamento della lampadina e una facile manutenzione.

A range of recessed indoor downlights installable on plasterboard ceilings. Telescopic is provided with a fixed part and a telescopic one. The latter part allows to place the light bulb both externally, at the level of the spotlight, or internally. This permits to choose among different and always new, peculiar solutions, depending on the desired effect.

Telescopic is equipped with a Coral® part, available in different shapes, and with a chromatic mechanism composed by a fixed part and an adjustable one. The adjustable part allows an easier relocation and maintenance of the luminaire.

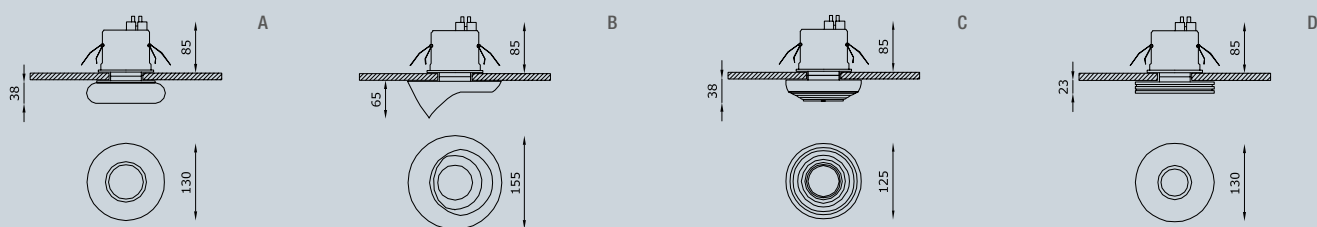

TECHNICAL FEATURES

Code	6001.00 (fig. A)	6003.00 (fig. B)	6004.00 (fig. C)	6006.00 (fig. D)
Type	Ceiling lamp ▲	Ceiling lamp ▲	Ceiling lamp ▲	Ceiling lamp ▲
Material	00: Coral®	00: Coral®	00: Coral®	00: Coral®
Weight	-	-	-	-
Mounting	Ceiling mounting	Ceiling mounting	Ceiling mounting	Ceiling mounting
IP rating	IP20	IP20	IP20	IP20
Insulation class	III	III	III	III
Control gear	Electronic transformer (not included)	Electronic transformer (not included)	Electronic transformer (not included)	Electronic transformer (not included)
Cut out for plasterboard	Ø 85 mm	Ø 85 mm	Ø 85 mm	Ø 85 mm
Lamp type	QR CB 51 🔊	QR CB 51 🔊	QR CB 51 🔊	QR CB 51 🔊
Lamp wattage	1 x 50W max	1 x 50W max	1 x 50W max	1 x 50W max
Luminous efficacy	-	-	-	-
Light distribution	-	-	-	-
Fitting	GU5.3	GU5.3	GU5.3	GU5.3
Light colour	-	-	-	-
Light hole	-	-	-	-
Voltage connection	By driver (optional)	By driver (optional)	By driver (optional)	By driver (optional)
CRI	-	-	-	-
Emergency	-	-	-	-
Energy efficiency class	A	A	A	A
Note	<p>Can use dicroic bulbs at a very low voltage 12V with Ø 50 mm dicroic reflector.</p> <p>The bulb can be positioned outside the fixture or all inside according to the effect that must be obtained.</p> <p>The terminal blocks are housed inside an insulating box.</p>	<p>Can use dicroic bulbs at a very low voltage 12V with Ø 50 mm dicroic reflector.</p> <p>The bulb can be positioned outside the fixture or all inside according to the effect that must be obtained.</p> <p>The terminal blocks are housed inside an insulating box.</p>	<p>Can use dicroic bulbs at a very low voltage 12V with Ø 50 mm dicroic reflector.</p> <p>The bulb can be positioned outside the fixture or all inside according to the effect that must be obtained.</p> <p>The terminal blocks are housed inside an insulating box.</p>	<p>Can use dicroic bulbs at a very low voltage 12V with Ø 50 mm dicroic reflector.</p> <p>The bulb can be positioned outside the fixture or all inside according to the effect that must be obtained.</p> <p>The terminal blocks are housed inside an insulating box.</p>

OPTIONAL ACCESSORIES

product code	optional code	description	info
6001.00 / 6003.00 / 6004.00 / 6006.00	H8060.LED	Dimmable electronic transformer	Max watt 60W Volts · Hz 230/12V · 50/60Hz
	H8105	Dimmable electronic transformer	Max watt 105W Volts · Hz 230/12V · 50/60Hz
	0008KIT	Kit LED dimmable	Bulb 7W · 12V

Telescopic

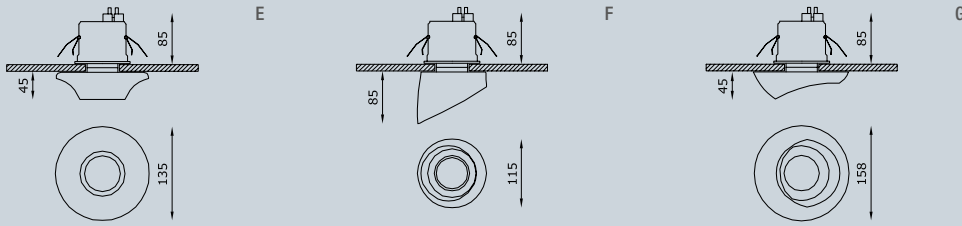

TECHNICAL FEATURES

Code	6007.00 (fig. E)	6010.00 (fig. F)	6011.00 (fig. G)
Type	Ceiling lamp ▲	Ceiling lamp ▲	Ceiling lamp ▲
Material	00: Coral®	00: Coral®	00: Coral®
Weight	-	-	-
Mounting	Ceiling mounting	Ceiling mounting	Ceiling mounting
IP rating	IP20	IP20	IP20
Insulation class	III	III	III
Control gear	Electronic transformer (not included)	Electronic transformer (not included)	Electronic transformer (not included)
Cut out for plasterboard	Ø 85 mm	Ø 85 mm	Ø 85 mm
Lamp type	QR CB 51 🔊	QR CB 51 🔊	QR CB 51 🔊
Lamp wattage	1 x 50W max	1 x 50W max	1 x 50W max
Luminous efficacy	-	-	-
Light distribution	-	-	-
Fitting	GU5.3	GU5.3	GU5.3
Light colour	-	-	-
Light hole	-	-	-
Voltage connection	By driver (optional)	By driver (optional)	By driver (optional)
CRI	-	-	-
Emergency	-	-	-
Energy efficiency class	A	A	A
Note	<p>Can use dicroic bulbs at a very low voltage 12V with Ø 50 mm dicroic reflector.</p> <p>The bulb can be positioned outside the fixture or all inside according to the effect that must be obtained.</p> <p>The terminal blocks are housed inside an insulating box.</p>	<p>Can use dicroic bulbs at a very low voltage 12V with Ø 50 mm dicroic reflector.</p> <p>The bulb can be positioned outside the fixture or all inside according to the effect that must be obtained.</p> <p>The terminal blocks are housed inside an insulating box.</p>	<p>Can use dicroic bulbs at a very low voltage 12V with Ø 50 mm dicroic reflector.</p> <p>The bulb can be positioned outside the fixture or all inside according to the effect that must be obtained.</p> <p>The terminal blocks are housed inside an insulating box.</p>

OPTIONAL ACCESSORIES

product code	optional code	description	info
6007.00 / 6010.00 / 6011.00	H8060.LED	Dimmable electronic transformer	Max watt 60W Volts · Hz 230/12V · 50/60Hz
	H8105	Dimmable electronic transformer	Max watt 105W Volts · Hz 230/12V · 50/60Hz
	0008KIT	Kit LED dimmable	Bulb 7W · 12V



Design
ASZ Architetti

ZEN

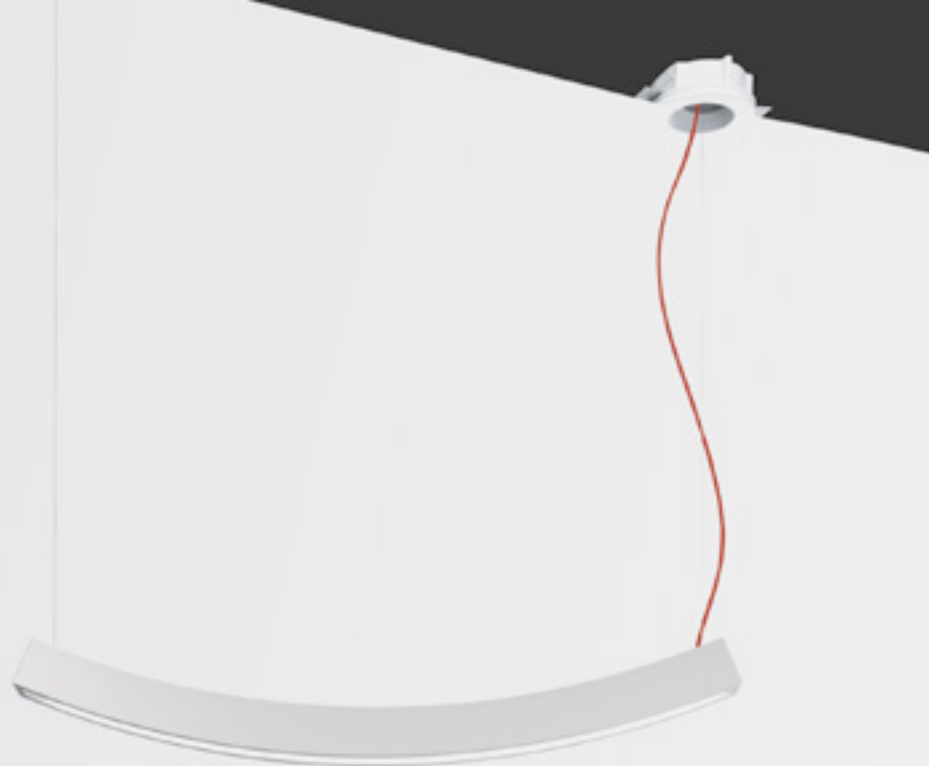

Zen è una lampada a sospensione da interni in AirCoral® fornita di LED 30W ad altissima efficienza, dalla tecnologia esclusiva e dalle forme particolari, in cui la materia si piega al servizio dell'architettura: dotato di uno schermo in policarbonato satinato in grado di creare una luce soffusa e omogenea. Zen è una linea di luce sottile di soli 26 mm, attraverso cui il prodotto diventa protagonista e impreziosisce gli ambienti. Disponibile con cassetta a soffitto verniciata bianca oppure con incasso a scomparsa totale per alloggiare il driver nel controsoffitto.

Zen is a suspended indoor luminaire made of AirCoral® with high-efficiency 30W LED, with an exclusive technology and a particular shape, where substance bends at the service of architecture: equipped with a satin polycarbonate screen that creates a suffused and consistent light, Zen is fine line light of just 26 mm, through which the product is protagonist, enhancing the rooms. Available with a white-painted ceiling case or with a recessed housing, that allows to place the driver in the false ceiling.

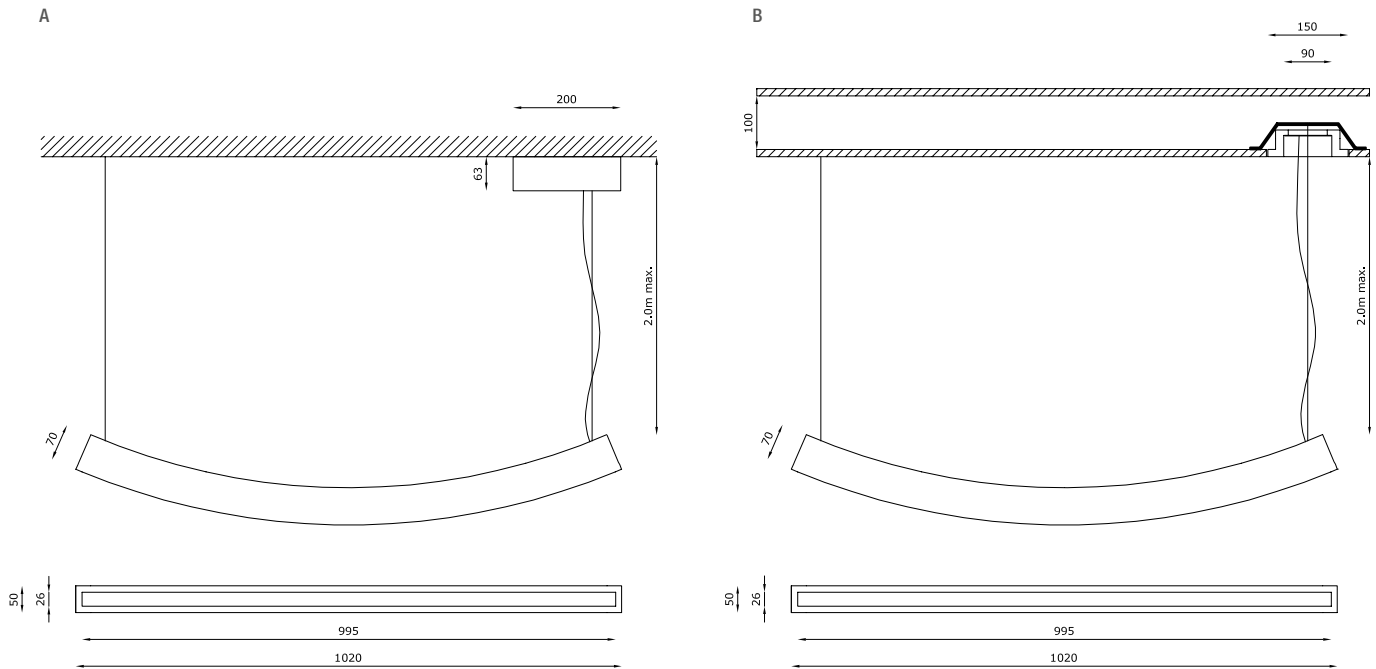

TECHNICAL FEATURES

Code	1451.AC (fig. A)	1452.AC (fig. B)
Type	Suspension lamp	Suspension lamp
Material	AC: AirCoral®	AC: AirCoral®
Absorption capacity*	13.54 m ²	13.54 m ²
Mounting	Ceiling mounting	Ceiling mounting
IP rating	IP40	IP40
Insulation class	III	III
Control gear	Constant voltage LED driver	Constant voltage LED driver
Cut out for plasterboard	-	Ø 160 mm
Lamp type	LED 24V ☐	LED 24V ☐
Lamp wattage	1 x 30W	1 x 30W
Luminous efficacy	3150 lm	3150 lm
Light distribution	Wide beam 120°	Wide beam 120°
Fitting	-	-
Light colour	White 3000K	White 3000K
Voltage connection	220-240V · 50/60Hz	220-240V · 50/60Hz
CRI	>80	>80
Emergency	-	-
Energy efficiency class	A++	A++
Note	Cable L max 2 m. White box ceiling for LED driver. Satin polycarbonate screen.	Cable L max 2 m. Recessed box of total disappearance for LED driver. Satin polycarbonate screen.

* The absorption capacity per m² calculated by the American organization TCNA (Tile Council of North America) is measured for an average room of 2.7 m in height and therefore expressed in m²





Private villa - Austria

Design

Fabio Rotella

FUNNEL LAMP



Un nome evocativo, che rispecchia alla perfezione il design dell'apparecchio: Funnel è una lampada a sospensione da interni, un imbuto di luce diretta dal design elegante e pulito, perfetto per valorizzare gli ambienti con raffinata semplicità. Le forme semplici e il design contemporaneo sono una caratteristica unica. Realizzato in AirCoral®, personalizzabile con finiture colorate, garantisce una perfetta combinazione di tecnologia e design. Disponibile singola, con incasso a soffitto o con cassetta in acciaio bianca verniciata in soft-touch, oppure con unica cassetta a tre sospensioni; con cavo in silicone trasparente regolabile per una lunghezza max di 2 m.

An evocative name, that perfectly reflects the design of this product: Funnel is an indoor suspended luminaire, a funnel of direct light with an elegant and clean design, perfect to enhance spaces with refined simplicity. The simple and the contemporary design are a unique feature. Made of AirCoral®, customizable with coloured finishings, it guarantees a perfect combination of technology and design. Available in single version with a recessed housing or with a steel, white-painted soft touch case, or even with three suspended lamps installed in a unique steel, white-painted ceiling case; provided with a transparent cable of silicone adjustable to a maximum of 2 m.



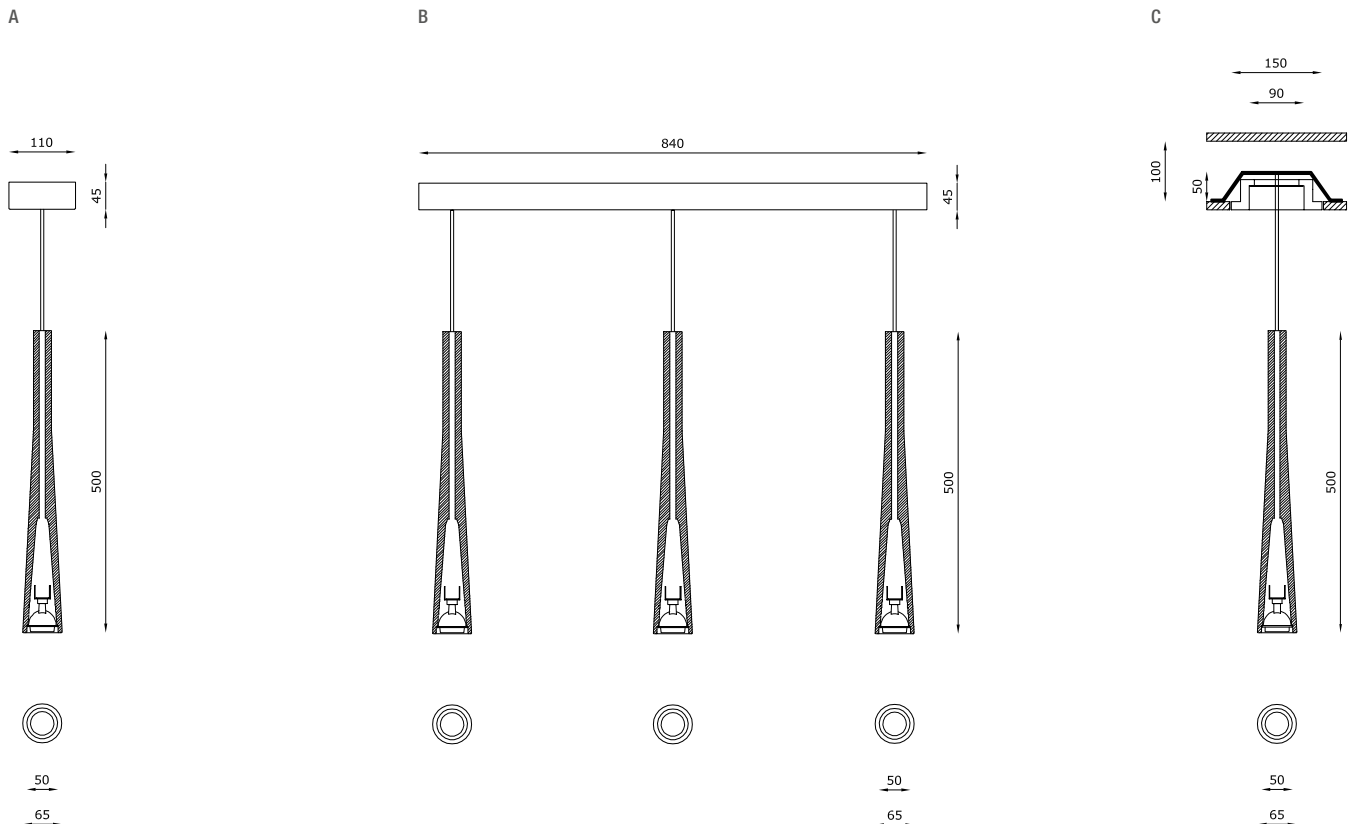

TECHNICAL FEATURES

Code	1408.AC (fig. A)	1409.AC (fig. B)	1407.AC (fig. C)
Type	Suspension lamp	Suspension lamp	Suspension lamp
Material	AC: AirCoral®	AC: AirCoral®	AC: AirCoral®
Absorption capacity*	3.87 m ²	11.61 m ²	3.87 m ²
Mounting	Ceiling mounting	Ceiling mounting	Ceiling mounting
IP rating	IP20	IP20	IP20
Insulation class	III	III	III
Control gear	Dimmable electronic transformer	Dimmable electronic transformer	Dimmable electronic transformer
Cut out for plasterboard	-	-	Ø 160 mm
Lamp type	LED 12V ☒☒	LED 12V ☒☒	LED 12V ☒☒
Lamp wattage	1 x 10W	3 x 10W	1 x 10W
Luminous efficacy	1 x 485 lm	3 x 485 lm	1 x 485 lm
Light distribution	Beam 24°	Beam 24°	Beam 24°
Fitting	GU5.3	GU5.3	GU5.3
Light colour	White 3000K	White 3000K	White 3000K
Voltage connection	220-240V · 50/60Hz	220-240V · 50/60Hz	220-240V · 50/60Hz
CRI	-	-	-
Emergency	-	-	-
Energy efficiency class	A	A	A
Note	White box ceiling for electronic transformer. Clear silicon cable (L max 2 m).	White box ceiling for electronic transformer. Clear silicon cable (L max 2 m).	Recessed box of total disappearance for electronic transformer. Clear silicon cable (L max 2 m).

* The absorption capacity per m² calculated by the American organization TCNA (Tile Council of North America) is measured for an average room of 2.7 m in height and therefore expressed in m²

Funnel Lamp



Private villa - Lugano

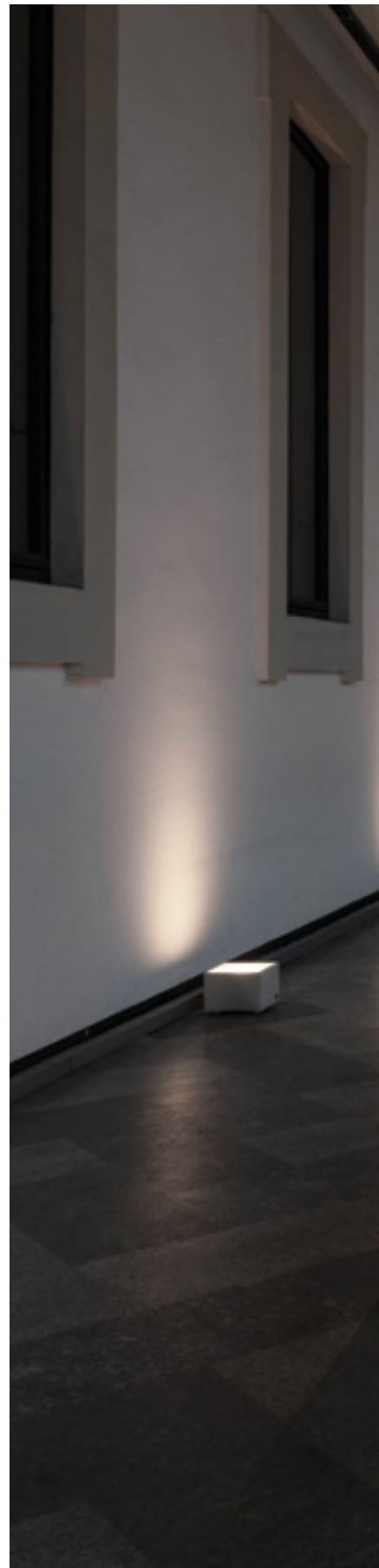



Università Statale di Milano - Marcio Kogan installation "Parla!" - Fuorisalone 2019

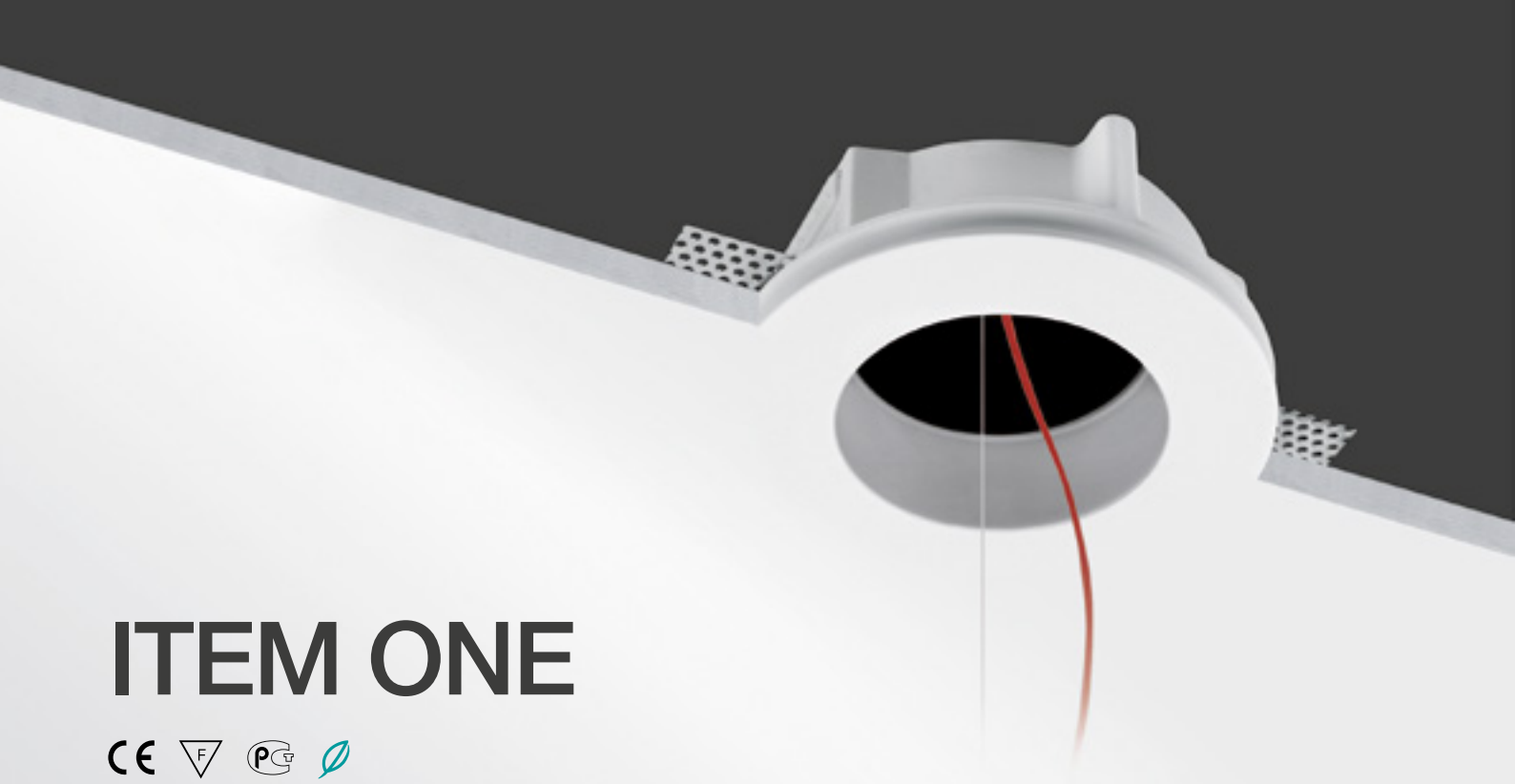

ITEM ONE



ROSONE UNIVESALE
PER QUALSIASI SOSPENSIONE FINO A 8 kg.

Tecnologia e versatilità: Item One è il nuovo incasso a scomparsa totale in AirCoral® per installazione a soffitto di cartongesso o laterizio adatto a sostenere lampade a sospensione di qualsiasi tipo e marca che abbiano una portata massimo di 8 Kg sulla base del tipo di soffitto.

Item One permette di sostituire i tradizionali rosoni e cassette a vista, e di alloggiare all'interno del controsoffitto driver e alimentatori, garantendo così una pulizia formale all'interno dello spazio architettonico.

UNIVERSAL ROSE
FOR ANY PENDANT UP TO 8 KG.

*Technology and versatility: Item One is the new total recessed luminaire made of AirCoral® and installable on plasterboard or brick ceilings. It is suitable for sustaining suspended lamps of any types and brands having a maximum range of 8 Kg in relation to the kind of ceiling. **Item One permits to substitute traditional rosettes and visible cases, integrating the driver and the power chargers within the false ceiling.** This guarantees a formal effect of elegance in the surrounding environment.*

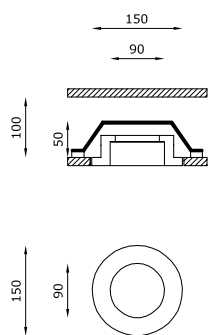

TECHNICAL FEATURES

Code	6212.AC
Type	Optional for suspension lamp
Material	AC: AirCoral®
Weight	0.9 Kg
Absorption capacity*	2.52 m ²
Mounting	Ceiling recessed
IP rating	-
Insulation class	-
Control gear	-
Cut out for plasterboard	Ø 160 mm
Lamp type	-
Lamp wattage	-
Luminous efficacy	-
Light distribution	-
Fitting	-
Light colour	-
Light hole	Ø 90 mm
Voltage connection	-
CRI	-
Emergency	-
Energy efficiency class	-
Note	Box for the installation of suspension lamp. Suitable for lamps up to 8 Kg. Recessed box of total disappearance for LED driver.

* The absorption capacity per m³ calculated by the American organization TCNA (Tile Council of North America) is measured for an average room of 2.7 m in height and therefore expressed in m²

Design

Marco Merendi

HOLE



Hole è una lampada da terra-tavolo con il corpo in Coral WaterOut® lavabile: un design esclusivo, un anello che genera una luce suggestiva, concreta e unica. Non solo una fonte luminosa, ma un vero e proprio oggetto d'arredo che diventa protagonista all'interno dello spazio abitativo, fondendosi in modo armonico con esso. Tecnologia, alta efficienza, design e qualità luminosa sono caratteristiche che rendono Hole un prodotto in grado di valorizzare qualsiasi ambiente.

Hole is a ground-table lamp with washable body in Coral Water Out®: an exclusive design, a ring that emits a suggestive, concrete and unique light. Not just a light source, but a real decorative item that becomes a protagonist inside the living space, blending harmonically with it. Technology, high efficiency, design and light quality are the features that make Hole a product able to enhance any environment.

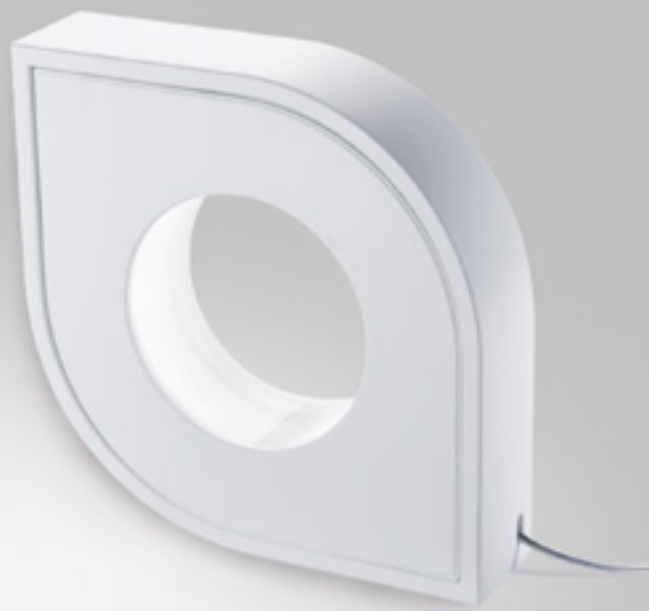

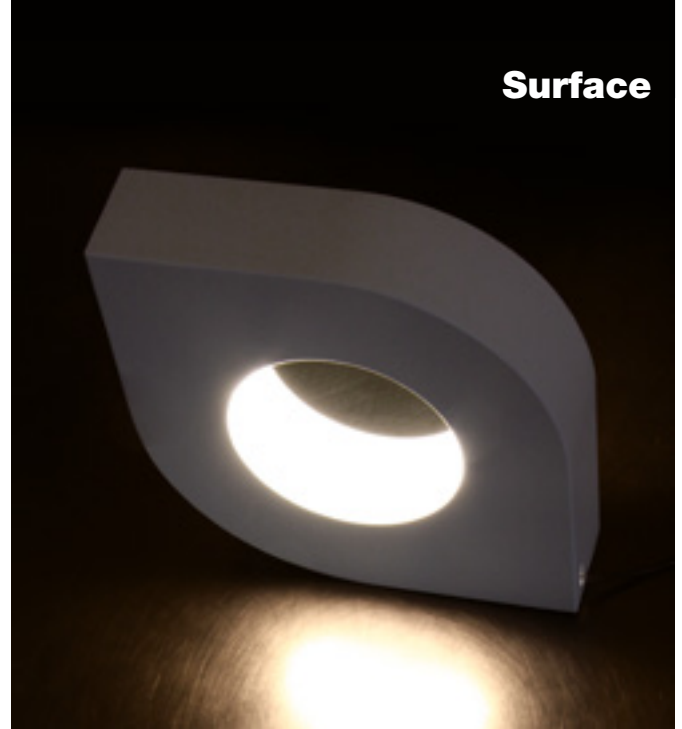
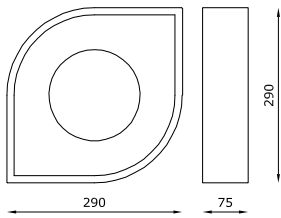

TECHNICAL FEATURES

Code	1604.CW
Type	Ground lamp
Material	CW: Coral WaterOut® waterproof
Mounting	Ground lamp
IP rating	IP40
Insulation class	I
Control gear	Electronic ballast
Lamp type	TR5 
Lamp wattage	1 x 22W
Luminous efficacy	-
Light distribution	-
Fitting	2GX13
Light colour	-
Voltage connection	220-240V · 50/60Hz
CRI	-
Emergency	-
Energy efficiency class	A+
Note	Extra white satin polycarbonate protection shield. Transparent silicone cable.



Outdoor

Where light and resistance live together



GENIUS IP65



1000 lm IN SOLI 24 mm DI DIAMETRO.
FACILE MANUTENZIONE.



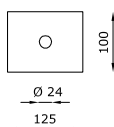
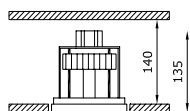

Genius IP65 è un incasso a scomparsa totale da esterni per installazione in soffitto di cartongesso o laterizio. La presenza di una lente protettiva IP65 satinata sulla sorgente luminosa e la sua combinazione con il corpo in Coral WaterOut®, lo rendono un prodotto resistente sia all'acqua che alla polvere. Con la versione per esterni la luce di Genius da oggi non ha più limiti ed è in grado di imporsi, discreto, in tutte le tipologie di ambiente. La parte elettrica è estraibile direttamente dal foro luce con un semplice gesto della mano, grazie alla meccanica push-pull, che facilita l'eventuale estrazione e la sostituzione della sorgente LED in caso di manutenzione.

1000 lm IN A DIAMETER OF JUST 24 mm,
EASY MAINTENANCE.

Genius IP65 is a total recessed outdoor luminaire installable on plasterboard or brick ceilings. The protective IP65 satin lens on the light source, perfectly merges with the Coral WaterOut® body, making the product resistant to both dust and water. With the outdoor version, Genius' light knows no limits and can now discreetly impose itself in any kinds of environments. The electrical part can be extracted directly from the emission hole with a simple hand gesture. This is possible thanks to the push-pull mechanism, which facilitates the eventual extraction and replacing of the LED source in case of maintenance.



TECHNICAL FEATURES

Code	1951.CW	1952.CW
Type	Downlight 90° 	Downlight 90° 
Material	CW: Coral WaterOut® waterproof	CW: Coral WaterOut® waterproof
Weight	0.8 Kg	0.8 Kg
Mounting	Ceiling recessed	Ceiling recessed
IP rating	IP65	IP65
Insulation class	III	III
Control gear	Remote constant current electronic driver (not included)	Remote constant current electronic driver and inverter
Cut out for plasterboard	135 x 110 mm	135 x 110 mm
Lamp type	LED 700 mA  Vf: 11.5 VDC	LED 700 mA 
Lamp wattage	1 x 8.5W	1 x 8.5W
Luminous efficacy	1000 lm - 3000K	1000 lm - 3000K
Light distribution	Wide beam 40°	Wide beam 40°
Fitting	-	-
Light colour	White 3000K White 2700K 4000K (on request)	White 3000K White 2700K 4000K (on request)
Light hole	Ø 24 mm	Ø 24 mm
Voltage connection	By driver (optional)	220-240V · 50/60Hz
CRI	>90	>90
Emergency	-	1 hour
Energy efficiency class	A++	A++
Note	On request available dimmable PUSH or DALI, remote installation.	On request available dimmable PUSH or DALI, remote installation.

OPTIONAL ACCESSORIES

product code	optional code	description	info
1951.CW	H8700.E	Constant current electronic driver. Remote installation	Suitable for n°1 or n°3 code 1951.CW - 700 mA
	BR1951LT	Brick box	Dimensions L: 195 mm; W: 140 mm; D: 160 mm <i>(instructions on page 502)</i>
1952.CW	BR1952LT	Brick box	Dimensions L: 195 mm; W: 140 mm; D: 160 mm <i>(instructions on page 502)</i>



Private villa - Austria



GENIUS BASIC IP65



LUCE RETROCESSA,
MINIMO INGOMBRO POSTERIORE.

Questa variante di prodotto aggiunge alle caratteristiche peculiari del Genius Basic il grado di protezione IP65, per applicazioni in spazi esterni e ambienti molto umidi. Genius Basic IP65, apparecchio da incasso a scomparsa totale per outdoor, ha la scocca realizzata in Coral WaterOut®, il brevetto Buzzi & Buzzi che unisce l'impermeabilità alle note caratteristiche del Coral®. Destinato al mercato Contract, Genius Basic IP65 garantisce tutta l'affidabilità tecnica di Buzzi & Buzzi: è in grado di erogare 540 lm dal foro di 20 mm ed è estremamente compatto, con possibilità di installazione in soli 80 mm di intercapedine.

La parte elettrica è direttamente estraibile dal foro luce, grazie a un nuovo sistema che facilita l'estrazione e la sostituzione della sorgente LED, senza la necessità di alcuna botola di ispezione e tantomeno di interventi invasivi in caso di manutenzione.

REAR LIGHT,
MINIMUM REAR DIMENSIONS.

This product version adds to the special characteristics of the Genius Basic IP65 protection level, for very damp indoor and outdoor applications. The body of the Genius Basic IP65, the totally recessed luminaire for outdoor use, is made in Coral WaterOut®, the Buzzi & Buzzi patent which adds being waterproof to the characteristic features of Coral®.

Designed for the Contract market, Genius Basic IP65 guarantees all the technical reliability of Buzzi & Buzzi: it can supply 540 lm from the usual light emission hole of 20 mm (0.79"), is extremely compact and can be installed in a cavity measuring only 80 mm (3.15").

The electrical part can be removed through the light hole, thanks to a mechanism making it easy to pull the LED light source out and replace it, so there is no need for any inspection hatch, nor for invasive maintenance operations.

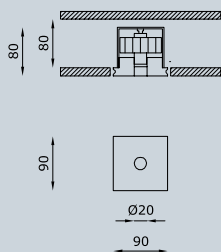

CODE COMPOSITION

1985.CW 4 R 24 E _ WD

light colour

27	2700K
30	3000K
40	4000K





1986.CW 4 R 24 E _ ND

light colour

27	2700K
30	3000K
40	4000K

example of code composition 1985.CW 4 R 24 E 30 WD

TECHNICAL FEATURES

Code	1985.CW XX	1986.CW XX
Type	Downlight 90° 	Downlight 90° 
Material	CW: Coral Waterout® waterproof	CW: Coral Waterout® waterproof
Weight	0.65 Kg	0.65 Kg
Mounting	Ceiling recessed	Ceiling recessed
IP rating	IP65	IP65
Insulation class	III	III
Control gear	Remote constant current electronic driver (not included)	Remote constant current electronic driver and inverter (included)
Cut out for plasterboard	100 x 100 mm	100 x 100 mm
Lamp type	LED 700 mA  Vf: 6.5 VDC	LED 700 mA 
Lamp wattage	1 x 4.5W	1 x 4.5W
Luminous efficacy	540 lm - 3000K	540 lm - 3000K
Light distribution	Wide beam 24°	Wide beam 24°
Fitting	-	-
Light colour	White 3000K White 2700K 4000K (on request)	White 3000K White 2700K 4000K (on request)
Light hole	Ø 20 mm	Ø 20 mm
Voltage connection	By driver (optional)	220-240V · 50/60Hz
CRI	>90	>90
Emergency	-	1 hour
Energy efficiency class	A++	A++
Note	On request available dimmable PUSH or DALI, remote installation.	On request available dimmable PUSH or DALI, remote installation.

OPTIONAL ACCESSORIES

product code	optional code	description	info
1985.CW XX	H8700.E	Constant current electronic driver. Remote installation	Suitable for n°3 code 1985.CW XX - 700 mA
	BR1985LT	Brick box	Dimensions L: 195 mm; W: 105 mm; D: 110 mm
1986.CW XX	BR1986LT	Brick box	Dimensions L: 195 mm; W: 105 mm; D: 110 mm

GENIUS NAKED IP65

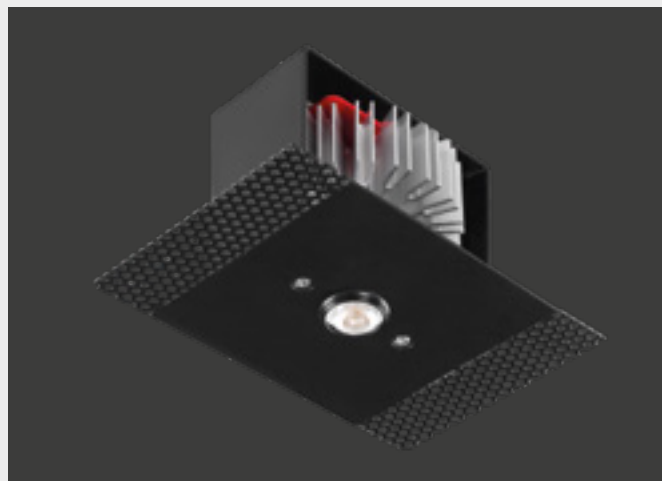

UN GENIUS NUDO
ADATTO PER QUALSIASI SUPPORTO E MATERIALE.

Genius Naked IP65 è un apparecchio a scomparsa totale a soffitto, adatto per esterni e ambienti molto umidi, grazie all'alto grado di protezione IP65. Questo prodotto estende il concetto di totale integrazione superficiale, tipico di Buzzi & Buzzi, a qualsiasi materiale e contesto: infatti può essere installato su qualsiasi superficie: legno, cemento, specchio, marmo, moduli industriali con uno spessore da 12 mm a massimo 20 mm.

Unica parte visibile è il foro di soli 20 mm, mentre la parte elettrica è estraibile direttamente dal foro luce, grazie alla meccanica push-pull, che facilita la sostituzione della sorgente LED, senza la necessità di alcuna botola di ispezione e tantomeno di interventi invasivi in caso di manutenzione.



A BARE GENIUS
SUITABLE FOR ANY SUPPORT AND MATERIAL.

Genius Naked IP65 is a totally recessed ceiling-mounted luminaire, suitable for use outdoors and in very damp environments, thanks to its high IP65 protection level.

This product extends the concept of total surface integration, typical of Buzzi & Buzzi, to any material and context: in fact, it can also be installed on wood, cement, mirror, marble and industrial modules with a thickness of from 12 mm (0.47") to a maximum of 20 mm (0.79"). The only visible part is the light emission hole measuring only 20 mm (0.79"), while the electrical part can be removed through the light hole, thanks to a push-pull mechanism making it easy to pull the LED light source out, with no need for any inspection hatch, nor for invasive maintenance operations.

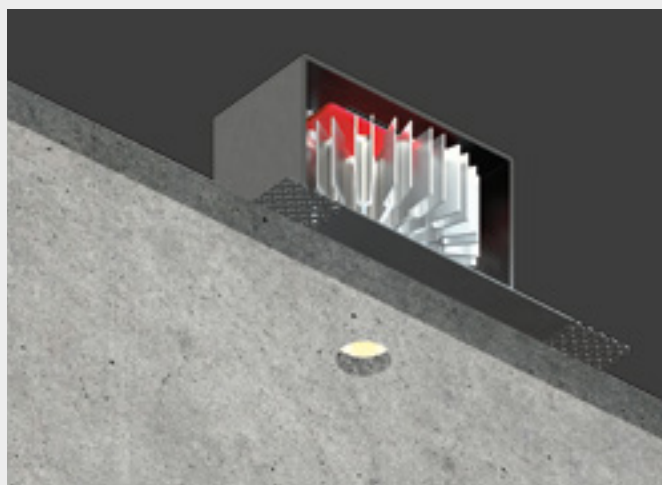

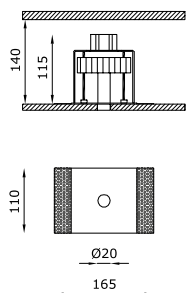

CODE COMPOSITION

2075 BL 4 R 40 E _ WD

light colour

27	2700K
30	3000K
40	4000K





2076 BL 4 R 40 E _ ND

light colour

27	2700K
30	3000K
40	4000K

example of code composition 2075 BL 4 R 40 E **30** WD

TECHNICAL FEATURES

Code	2075 XX	2076 XX
Type	Downlight 90° 	Downlight 90° 
Material	Aluminum I Steel	Aluminum I Steel
Finishing	Black	Black
Weight	0.65 Kg	0.65 Kg
Mounting	Ceiling recessed	Ceiling recessed
IP rating	IP65	IP65
Insulation class	III	III
Control gear	Remote constant current electronic driver (not included)	Remote constant current electronic driver and inverter (included)
Lamp type	LED 700 mA  Vf: 11.5 VDC	LED 700 mA 
Lamp wattage	1 x 8.5W	1 x 8.5W
Luminous efficacy	1000 lm - 3000K	1000 lm - 3000K
Light distribution	Wide beam 40°	Wide beam 40°
Fitting	-	-
Light colour	White 3000K White 2700K I 4000K (on request)	White 3000K White 2700K I 4000K (on request)
Light hole	Ø 20 mm	Ø 20 mm
Voltage connection	By driver (optional)	220-240V · 50/60Hz
CRI	>90	>90
Emergency	-	1 hour
Energy efficiency class	A++	A++
Note	On request available dimmable PUSH or DALI, remote installation. Suitable for installation on surfaces max 20 mm deep.	On request available dimmable PUSH or DALI, remote installation. Suitable for installation on surfaces max 20 mm deep.

OPTIONAL ACCESSORIES

product code	optional code	description	info
2075 XX	H8700.E	Constant current electronic driver. Remote installation	Suitable for n°1 or n°3 code 2075 XX - 700 mA

GENIUS BASIC NAKED IP65

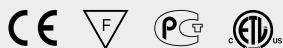

IL PIÙ COMPATTO DA INSTALLARE SU QUALSIASI MATERIALE.

La versione da esterni di Genius Basic Naked vive ora in Genius Basic Naked IP65. Questo apparecchio da incasso a scomparsa totale per esterni, è ingegnerizzato per raggiungere un grado di protezione IP65. Essendo una variante della versione Naked, questo prodotto estende il concetto di totale integrazione superficiale a qualsiasi materiale e contesto ed inoltre aggiunge le potenzialità tipiche della linea Basic. Genius Basic Naked IP65 è un prodotto molto compatto, sintesi della ricerca Buzzi & Buzzi in termini di versatilità, efficienza ed affidabilità: flusso luminoso da 540 lm, installabile in soli 80 mm di intercapedine, con protezione IP65. Può essere installato su qualsiasi superficie: legno, cemento, specchio, marmo, moduli industriali con spessore da 12 mm a 30 mm. Tipicamente Genius, unica parte visibile è il foro luce di 20 mm, da cui è estraibile la sorgente LED grazie a un sistema che facilita la sostituzione del corpo illuminante, senza necessità di alcuna botola di ispezione e tantomeno di interventi invasivi in caso di manutenzione.

THE MOST COMPACT TO INSTALL ON ANY MATERIAL.

The outdoors version of Genius Basic Naked is now available in the Basic Naked IP65 model. This totally recessed luminaire for outdoor use has been engineered to achieve an IP65 protection level. Since it is a new version of the Naked model, this product extends the concept of total surface integration to any material and contexts and also achieves the potentials typical of the Basic line.

Genius Basic Naked IP65 is a very compact product, a synthesis of Buzzi & Buzzi research in terms of versatility, efficiency and reliability: a light flow of 540 lm, installable in a cavity of only 80 mm (3.15"), with IP65 protection. It can also be installed on wood, cement, mirror, marble and industrial modules with a thickness of from 12 mm (0.47") to a maximum of 30 mm (1.18"). Typically Genius, the only visible part is the light emission hole measuring 20 mm (0.79"), from which the LED light source can be pulled out thanks to a system which makes it easy to replace the light source, so there is no need for any inspection hatch, nor for invasive maintenance.

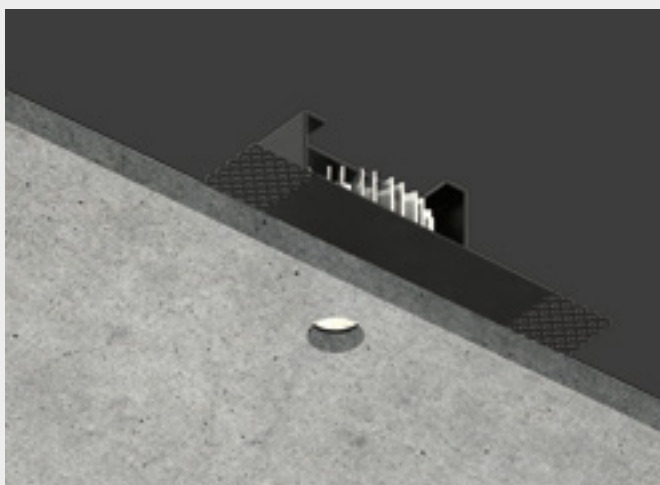
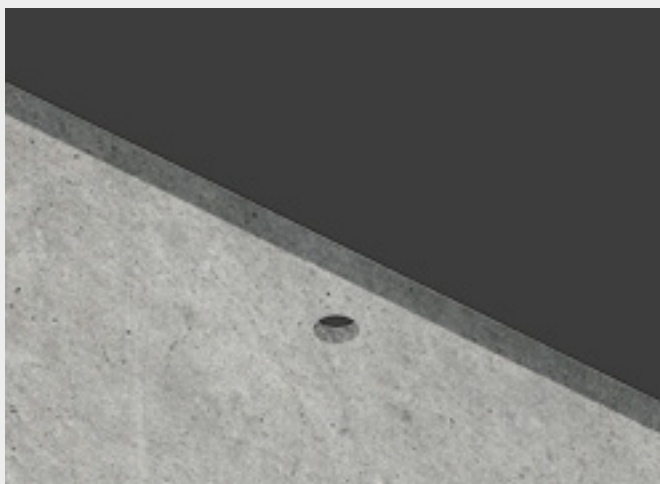
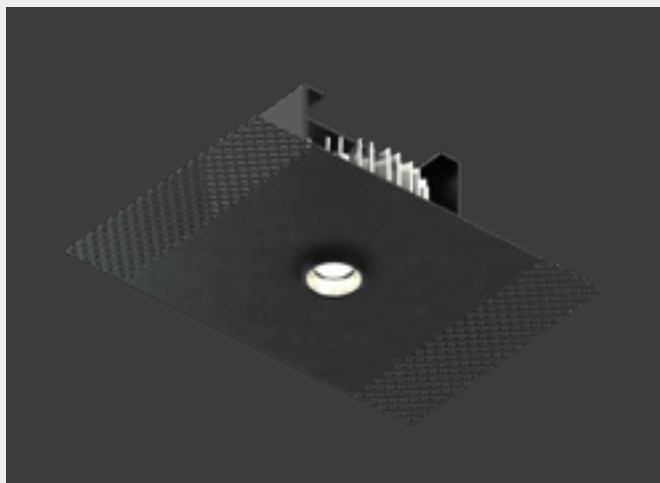

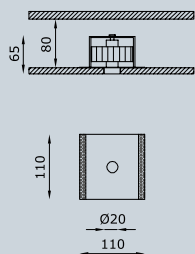

CODE COMPOSITION

2071 BL 4 R 24 E _ WD

light colour

27	2700K
30	3000K
40	4000K

2072 BL 4 R 24 E _ ND





light colour

27	2700K
30	3000K
40	4000K

example of code composition

2071 BL 4 R 24 E **30** WD

TECHNICAL FEATURES

Code	2071 XX	2072 XX
Type	Downlight 90° 	Downlight 90° 
Material	Aluminum I Steel	Aluminum I Steel
Finishing	Black	Black
Weight	0.65 Kg	0.65 Kg
Mounting	Ceiling recessed	Ceiling recessed
IP rating	IP65	IP65
Insulation class	III	III
Control gear	Remote constant current electronic driver (not included)	Remote constant current electronic driver and inverter (included)
Lamp type	LED 700 mA  Vf: 6.5 VDC	LED 700 mA 
Lamp wattage	1 x 4.5W	1 x 4.5W
Luminous efficacy	540 lm - 3000K	540 lm - 3000K
Light distribution	Wide beam 24°	Wide beam 24°
Fitting	-	-
Light colour	White 3000K White 2700K I 4000K (on request)	White 3000K White 2700K I 4000K (on request)
Light hole	Ø 20 mm	Ø 20 mm
Voltage connection	By driver (optional)	220-240V · 50/60Hz
CRI	>90	>90
Emergency	-	1 hour
Energy efficiency class	A++	A++
Note	On request available dimmable PUSH or DALI, remote installation. Suitable for installation on surfaces max 20 mm deep.	On request available dimmable PUSH or DALI, remote installation. Suitable for installation on surfaces max 20 mm deep.

OPTIONAL ACCESSORIES

product code	optional code	description	info
2071 XX	H8700.E	Constant current electronic driver. Remote installation	Suitable for n°3 code 2071 XX - 700 mA



INVISIBLED IP44 / IP65



MINIME DIMENSIONI: 40 x 40 mm.

Invisiled IP44/IP65 è un apparecchio da esterni, incasso a scomparsa totale in Coral WaterOut® per l'installazione a parete e soffitto di cartongesso o laterizio. Il prodotto si fa invisibile per conferire valore aggiunto al ruolo della luce negli spazi outdoor: uno stile discreto e minimale, una vera e propria guida luminosa, in grado di reinventare l'architettura, aggiungendo qualità all'ambiente. Un apparecchio versatile, che esalta gli spazi fondendosi con essi, per creare scenografie di luce.

MINIMUM DIMENSIONS: 40 x 40 mm.

Invisiled IP44/IP65 is a totally disappearing outdoor recessed luminaire made of Coral WaterOut®, installable on plasterboard or brick walls and ceilings. This product becomes invisible to lend an added value to the role of light in outdoor spaces: a discreet and minimal style, a real bright guide, able to reinvent the architecture, adding quality to the environment. A versatile luminaire, that enhances spaces blending together with them, in order to create settings of light.

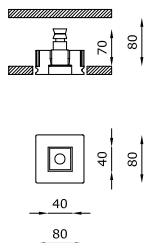

TECHNICAL FEATURES

Code	6349.CW	6347.CW
Type	Downlight 90° Wall lamp 90° 	Downlight 90° Wall lamp 90°
Material	CW: Coral WaterOut® waterproof	CW: Coral WaterOut® waterproof
Weight	0.3 Kg	0.3 Kg
Mounting	Wall and ceiling recessed	Wall and ceiling recessed
IP rating	IP44	IP65
Insulation class	III	III
Control gear	Constant current electronic driver (not included)	Constant current electronic driver (not included)
Cut out for plasterboard	90 x 90 mm	90 x 90 mm
Lamp type	LED Vf: 3 VDC	LED Vf: 3 VDC
Lamp wattage	1W - 350 mA 2W - 500 mA	1W - 350 mA 2W - 500 mA
Luminous efficacy	75 lm - 3000K 350 mA 170 lm - 3000K 500 mA	75 lm - 3000K 350 mA 170 lm - 3000K 500 mA
Light distribution	Narrow beam 14°	Narrow beam 14°
Fitting	-	-
Light colour	White 3000K White 2700K (on request)	White 3000K White 2700K (on request)
Light hole	40 x 40 mm	40 x 40 mm
Voltage connection	By driver (optional)	By driver (optional)
CRI	>90	>90
Emergency	-	-
Energy efficiency class	A++	A++
Note	On request available dimmable PUSH or DALI, remote installation.	On request available dimmable PUSH or DALI, remote installation.

OPTIONAL ACCESSORIES

<i>product code</i>	<i>optional code</i>	<i>description</i>	<i>info</i>
6349.CW / 6347.CW	H8350	Constant current electronic driver	Suitable for n°1 code 6349.CW / 6347.CW - 350 mA
	H8500.B	Constant current electronic driver. Remote installation	Suitable for n°5 code 6349.CW / 6347.CW - 500 mA
	H8500.C	Constant current electronic driver. Remote installation	Suitable for n°2 code 6349.CW / 6347.CW - 500 mA





IDROUT IP65



INCASSO CON SORGENTE LUMINOSA A VISTA.

Idrout IP65 è un apparecchio da esterni, incasso a scomparsa totale in Coral WaterOut® che, grazie al design lineare, pulito e minimale, sa integrarsi alla perfezione nelle superfici, raggiungendo uno straordinario risultato di scomparsa totale. Idrout IP65 è adatto per l'installazione in ambienti umidi, come bagni o SPA, garantendo l'impermeabilità e una lunga durata nel tempo. Una luce essenziale che dialoga con un prodotto altamente tecnico. La sorgente retrocessa dona una luce precisa e puntuale, senza compromettere funzionalità e design.





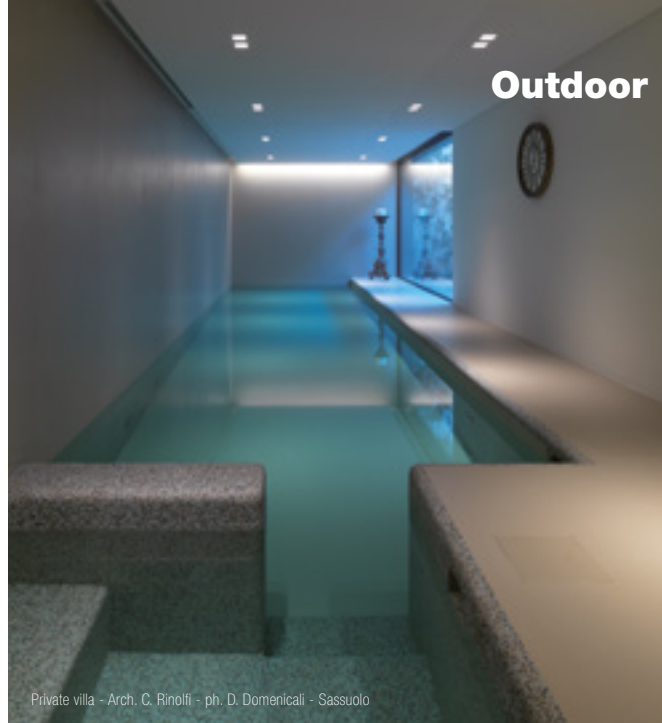
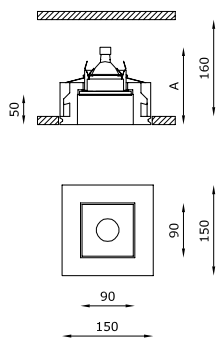

RECESSED FITTING WITH EXPOSED LIGHT SOURCE.

Idrout IP65 is a totally disappearing outdoor recessed luminaire made of Coral WaterOut®; thanks to its linear, neat and minimal design, it is able to perfectly integrate inside surfaces, achieving an extraordinary result of total disappearance. Idrout IP65 is ideal to be installed in moist environments, such as bathrooms or SPAs, guaranteeing impermeability and long duration over time. An essential light interacting with a highly technical product. The backward light source emanates a precise and punctual beam which does not compromise functionality and design.



Private villa - Arch. C. Rinolfi - ph. D. Domenicali - Sassuolo

TECHNICAL FEATURES

Code	5483.Z.CW	5489.Z.CW	5481.CW
Type	Downlight 90° 	Downlight 90° 	Downlight 90° 
Material	CW: Coral WaterOut® waterproof	CW: Coral WaterOut® waterproof	CW: Coral WaterOut® waterproof
Weight	1.1 Kg	1.1 Kg	1.1 Kg
Mounting	Ceiling recessed	Ceiling recessed	Ceiling recessed
IP rating	IP65	IP65	IP65
Insulation class	III	III	III
Control gear	Constant current electronic driver (not included)	Constant current electronic driver	Electronic transformer (not included)
Dimensions	A: 150 mm	A: 150 mm	A: 130 mm
Cut out for plasterboard	160 x 160 mm	160 x 160 mm	160 x 160 mm
Lamp type	LED 500 mA  Vf: 18 VDC	LED 500 mA 	QR CB 51 
Lamp wattage	1 x 9W	1 x 9W	1 x 50W max
Luminous efficacy	1125 lm - 3000K	1125 lm - 3000K	-
Light distribution	Wide beam 40°	Wide beam 40°	-
Fitting	-	-	GU5.3
Light colour	White 3000K White 2700K 4000K (on request)	White 3000K White 2700K 4000K (on request)	-
Light hole	90 x 90 mm	90 x 90 mm	90 x 90 mm
Voltage connection	By driver (optional)	220-240V · 50/60Hz	By driver (optional)
CRI	>90	>90	-
Emergency	-	1 hour	-
Energy efficiency class	A++	A++	A
Note	On request available dimmable PUSH or DALI.	-	-

OPTIONAL ACCESSORIES

product code	optional code	description	info
5483.Z.CW	H8500.E	Constant current electronic driver	Suitable for n°2 code 5483.Z.CW - 500 mA
	H8500.B	Constant current electronic driver	Suitable for n°1 code 5483.Z.CW - 500 mA
	BR5483LT	Brick box	Dimensions L: 195 mm; W: 160 mm; D: 160 mm (instructions on page 502)
5481.CW	H8060.LED	Dimmable electronic transformer	Max watt 60W Volts · Hz 230/12V · 50/60Hz
	0008KIT	Kit LED dimmable	Bulb 7W · 12V
	BR5481LT	Brick box	Dimensions L: 195 mm; W: 160 mm; D: 160 mm (instructions on page 502)



Private villa - A. Ogarrió J. Zapata Arquitectos SC - Mexico





IDROROUND IP65



INCASSO CON SORGENTE LUMINOSA A VISTA.

Idroround IP65, apparecchio da esterni, incasso a scomparsa totale in Coral WaterOut® adatto per l'installazione in SPA, wellness club o ambienti umidi in cui luce ed acqua giocano un ruolo fondamentale. Per le sue particolari caratteristiche tecniche, Idroround IP65 è infatti in grado di garantire la perfetta luminosità dei locali e, allo stesso tempo, di resistere all'umidità presente in questi ambienti. Impermeabilità, durata, resistenza, durezza e un'illuminazione dal fascino unico. La sorgente luminosa retrocessa dona una luce precisa e puntuale, senza sacrificare l'eleganza degli spazi.

RECESSED FITTING WITH EXPOSED LIGHT SOURCE.

Idroround IP65 is a totally disappearing outdoor recessed luminaire made of Coral WaterOut®, perfect for installation inside SPAs, wellness clubs or moist environments where light and water play a key role. Thanks to its particular technical features, Idroround IP65 is able to guarantee to spaces a perfect lighting yet resisting to the humidity found inside these areas. Impermeability, durability, resistance, toughness and a uniquely fascinating light. The backward light source emanates a precise and punctual beam which does not affect space elegance.

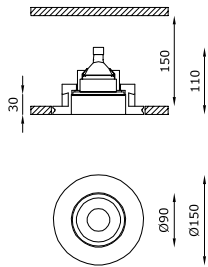

Private house - A. Castrignano - ph. R. Gasperoni - Milan

TECHNICAL FEATURES

Code	5593.Z.CW	5599.Z.CW	5591.CW
Type	Downlight 90° ▲	Downlight 90° ▲	Downlight 90° ▲
Material	CW: Coral WaterOut® waterproof	CW: Coral WaterOut® waterproof	CW: Coral WaterOut® waterproof
Weight	1.1 Kg	1.1 Kg	1.1 Kg
Mounting	Ceiling recessed	Ceiling recessed	Ceiling recessed
IP rating	IP65	IP65	IP65
Insulation class	III	III	III
Control gear	Constant current electronic driver (not included)	Constant current electronic driver	Electronic transformer (not included)
Cut out for plasterboard	Ø 160 mm	Ø 160 mm	Ø 160 mm
Lamp type	LED 500 mA ⚡ V: 18 VDC	LED 500 mA ⚡	QR CB 51 🔊
Lamp wattage	1 x 9W	1 x 9W	1 x 50W max
Luminous efficacy	1125 lm - 3000K	1125 - 3000K	-
Light distribution	Wide beam 40°	Wide beam 40°	-
Fitting	-	-	GU5.3
Light colour	White 3000K White 2700K 4000K (on request)	White 3000K White 2700K 4000K (on request)	-
Light hole	Ø 90 mm	Ø 90 mm	Ø 90 mm
Voltage connection	By driver (optional)	220-240V · 50/60Hz	By driver (optional)
CRI	>90	>90	-
Emergency	-	1 hour	-
Energy efficiency class	A++	A++	A
Note	On request available dimmable PUSH or DALI.	-	-

OPTIONAL ACCESSORIES

product code	optional code	description	info
5593.Z.CW	H8500.E	Constant current electronic driver	Suitable for n°2 code 5593.Z.CW - 500 mA
	H8500.B	Constant current electronic driver	Suitable for n°1 code 5593.Z.CW - 500 mA
	BR5593LT	Brick box	Dimensions L: 195 mm; W: 160 mm; D: 160 mm (instructions on page 502)
5591.CW	H8060.LED	Dimmable electronic transformer	Max watt 60W Volts · Hz 230/12V · 50/60Hz
	0008KIT	Kit LED dimmable	Bulb 7W · 12V
	BR5591LT	Brick box	Dimensions L: 195 mm; W: 160 mm; D: 160 mm (instructions on page 502)





Private villa - A. Ogarrió J. Zapata Arquitectos SC - Mexico



ORIS IP65



INCASSO CON VETRO RETROCESSO,
MASSIMA INVISIBILITÀ.

Oris IP65 è un apparecchio da esterni, incasso a scomparsa totale in Coral WaterOut® per l'installazione a soffitto di cartongesso o laterizio: una volta installato, scompare completamente alla vista. Oris IP65 è la soluzione migliore per l'installazione in SPA, wellness club o spazi privati in cui luce ed acqua hanno un ruolo fondamentale. Per le sue particolari caratteristiche tecniche, è infatti in grado di garantire la giusta luminosità dei locali e, allo stesso tempo, di resistere all'umidità solitamente presente in questi ambienti.

*RECESSED FITTING WITH REAR GLASS,
MAXIMUM INVISIBILITY.*

Oris IP65 is a totally disappearing outdoor recessed luminaire made of Coral WaterOut®, installable on plasterboard or brick walls and ceilings: once installed, it completely disappears out of sight. Oris IP65 is the perfect solution for the installation inside SPAs, wellness clubs or private spaces where light and water play a key role. Thanks to its particular technical features, Oris IP65 is, in fact, able to guarantee to spaces their perfect lighting while resisting to the humidity in these areas.

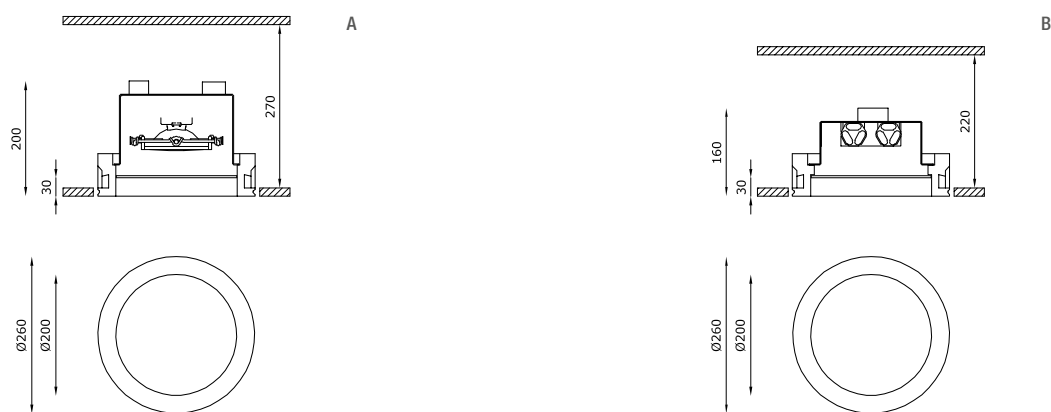

TECHNICAL FEATURES

Code	5371.CW (fig. A)	5376.CW (fig. B)	5385.CW (fig. B)	5381.CW (fig. B)	5388.CW (fig. B)
Type	Tilttable downlight ± 30° 	Downlight 90° 	Downlight 90° 	Downlight 90° 	Downlight 90°
Material	CW: Coral WaterOut® waterproof	CW: Coral WaterOut® waterproof	CW: Coral WaterOut® waterproof	CW: Coral WaterOut® I waterproof	CW: Coral WaterOut® waterproof
Weight	3.6 Kg	3.6 Kg	3.8 Kg	4 Kg	4 Kg
Mounting	Ceiling recessed	Ceiling recessed	Ceiling recessed	Ceiling recessed	Ceiling recessed
IP rating	IP65	IP65	IP65	IP65	IP65
Insulation class	III	I	I	I	I
Control gear	Dimmable electronic transformer	Electronic ballast	Electronic ballast	Constant current electronic driver	Dimmable constant current driver
Cut out for plasterboard	Ø 270 mm	Ø 270 mm	Ø 270 mm	Ø 270 mm	Ø 270 mm
Lamp type	QR 111 	TC-TEL 	TC-TEL 	LED 1050 mA 	LED 350 mA
Lamp wattage	1 x 100W max	2 x 26/32W	2 x 26W	1 x 40W	2 x 6.5W
Luminous efficacy	-	-	-	4680 lm - 3000K	2 x 810 lm - 3000K
Light distribution	-	-	-	Wide beam 40°	Wide beam 120°
Fitting	G53	Gx24q-3	Gx24q-3	-	-
Light colour	-	-	-	White 3000K White 2700K 4000K (on request)	White 3000K White 2700K 4000K (on request)
Light hole	Ø 200 mm	Ø 200 mm	Ø 200 mm	Ø 200 mm	Ø 200 mm
Voltage connection	220-240V / 12V · 50/60Hz	220-240V · 50/60Hz	220-240V · 50/60Hz	220-240V · 50/60Hz	220-240V · 50/60Hz
CRI	-	-	-	>90	>90
Emergency	-	-	1 hour	-	-
Energy efficiency class	A	A	A	A++	A+
Note	Extra white satin glass. Frosted glass recessed 30 mm into the ceiling.	Extra white satin glass. Frosted glass recessed 30 mm into the ceiling.	Extra white satin glass. Frosted glass recessed 30 mm into the ceiling.	Extra white satin glass. Frosted glass recessed 30 mm into the ceiling.	Extra white satin glass. Frosted glass recessed 30 mm into the ceiling.

Trailing-edge and leading-edge dimming (20 - 100%).

OPTIONAL ACCESSORIES

product code	optional code	description	info
5371.CW	00010KIT	Kit LED dimmable	Bulb 10W - 12V
5376.CW	BR5376LT	Brick box	Dimensions L: 445 mm; W: 270 mm; D: 225 mm (instructions on page 502)
5388.CW	BR5388LT	Brick box	Dimensions L: 445 mm; W: 270 mm; D: 225 mm (instructions on page 502)



Lounge Restaurant - Matteo Thun & Partners - Ascona



PHANTOM IP44 / IP65



INCASSO WALL WASHER DI PICCOLE DIMENSIONI.

Phantom IP44/IP65 è un apparecchio da esterni, incasso a scomparsa totale per l'installazione a parete e soffitto di cartongesso o laterizio. La soluzione più corretta per introdurre la luce negli ambienti esterni, grazie al materiale in Coral WaterOut®, con l'obiettivo di raccontare scenari sempre diversi. L'illuminazione definisce gli spazi, li determina, li valorizza, stagliandosi, netta, attraverso le superfici.

SMALL WALL WASHER RECESSED FITTING.

Phantom IP44/IP65 is a totally disappearing outdoor recessed luminaire, installable on plasterboard or brick walls and ceilings. It is the best solution to spread light on external environments thanks to the material it is made of, Coral WaterOut®, narrating ever different landscapes. Its lighting defines, determines and enhances spaces, standing out, sharply, through surfaces.

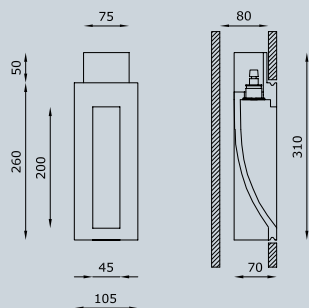

TECHNICAL FEATURES

Code	6489.CW	6487.CW
Type	Wall-washer 	Wall-washer
Material	CW: Coral WaterOut® waterproof	CW: Coral WaterOut® waterproof
Weight	1.4 Kg	1.4 Kg
Mounting	Wall and ceiling recessed	Wall and ceiling recessed
IP rating	IP44	IP65
Insulation class	III	III
Control gear	Constant current electronic driver (not included)	Constant current electronic driver (not included)
Cut out for plasterboard	115 x 270 mm	115 x 270 mm
Lamp type	LED Vf: 3 VDC	LED Vf: 3 VDC
Lamp wattage	1W - 350 mA 2W - 500 mA	1W - 350 mA 2W - 500 mA
Luminous efficacy	75 lm - 3000K 350 mA 170 lm - 3000K 500 mA	75 lm - 3000K 350 mA 170 lm - 3000K 500 mA
Light distribution	Narrow beam 14°	Narrow beam 14°
Fitting	-	-
Light colour	White 3000K White 2700K (on request)	White 3000K White 2700K (on request)
Light hole	45 x 200 mm	45 x 200 mm
Voltage connection	By driver (optional)	By driver (optional)
CRI	>90	>90
Emergency	-	-
Energy efficiency class	A++	A++
Note	On request available dimmable PUSH or DALI, remote installation.	On request available dimmable PUSH or DALI, remote installation.

OPTIONAL ACCESSORIES

product code	optional code	description	info
6489.CW / 6487.CW	H8350	Constant current electronic driver	Suitable for n°1 code 6489.CW / 6487.CW - 350 mA (IP40)
	H8500.B	Constant current electronic driver. Remote installation	Suitable for n°5 code 6489.CW / 6487.CW - 500 mA (IP40)
	H8500.C	Constant current electronic driver. Remote installation	Suitable for n°2 code 6489.CW / 6487.CW - 500 mA (IP40)
	BR6489LT / BR6487LT	Brick box	Dimensions L: 340 mm; W: 115 mm; D: 80 mm (instructions on page 502)

Design

Mammini + Candido

BLADE IP44 / IP65



SISTEMA MODULARE E TAGLIABILE A MISURA.

Blade IP44/IP65 è un sistema modulare a scomparsa totale in Coral WaterOut® per l'installazione a parete e soffitto di cartongesso o laterizio. Una lama di luce che fende il buio, che segna i percorsi, che determina gli spazi esterni. Blade può essere utilizzata a moduli multipli con una o due sorgenti luminose contrapposte che illuminano il corpo interno. Integrato nella parete o nel soffitto, crea scenografie luminose dal fascino unico e suggestivo.

MODULAR SYSTEM WHICH CAN BE CUT TO MEASURE.

Blade IP44/IP65 is a totally disappearing modular system made of Coral WaterOut®, installable on plasterboard or brick walls and ceilings. A blade of light slashing the darkness, highlighting paths, defining outdoor spaces. Blade can be used in multiple modules with one or two counterposed light sources that illuminate its internal body. Integrated inside walls or ceilings, it creates bright settings with a unique and suggestive appeal.



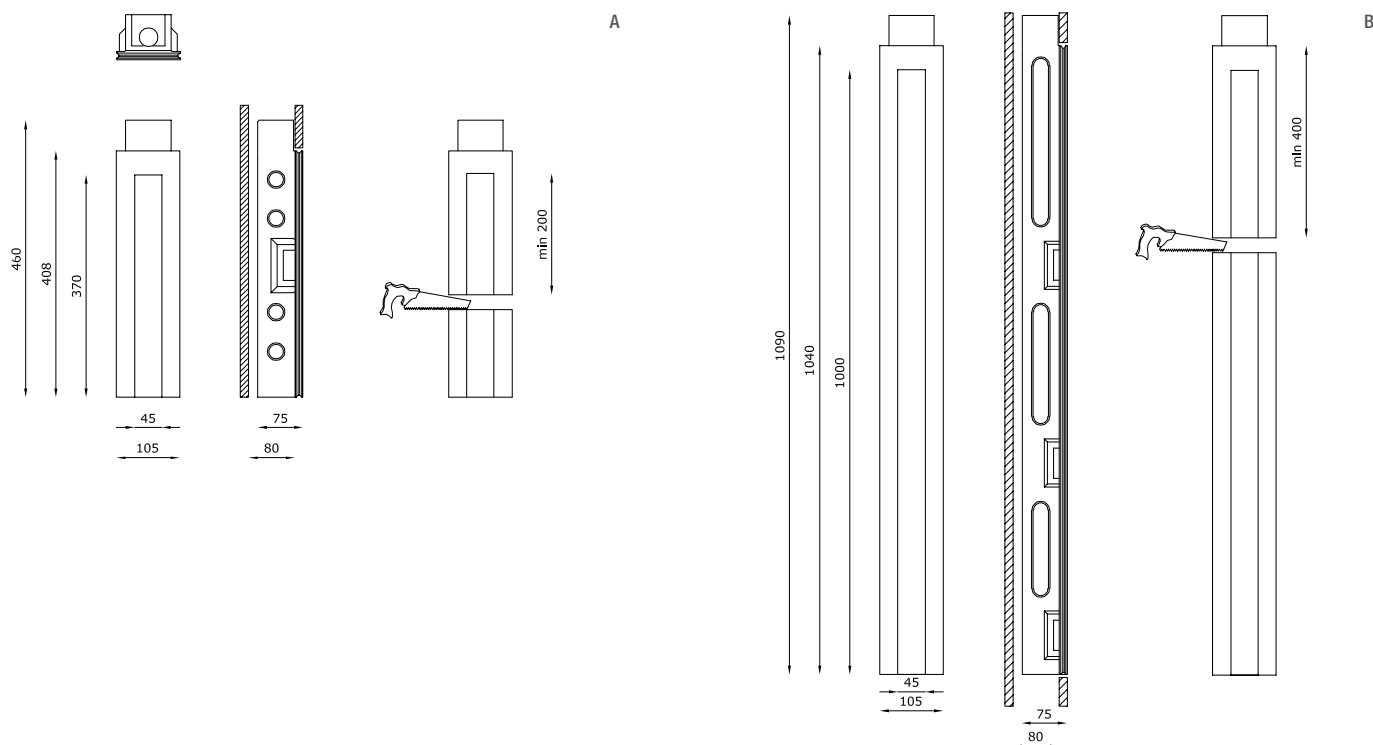

TECHNICAL FEATURES | ELECTRIFIED BODY

Code	6965.CW (fig.A)	6966.CW (fig.B)	6987.CW (fig.A)	6988.CW (fig.B)
Type	Downlight 90° Wall recessed 90° ▲▲▲	Downlight 90° Wall recessed 90° ▲▲▲	Downlight 90° Wall recessed 90° ▲▲▲	Downlight 90° Wall recessed 90° ▲▲▲
Material	CW: Coral WaterOut® waterproof	CW: Coral WaterOut® waterproof	CW: Coral WaterOut® waterproof	CW: Coral WaterOut® waterproof
Weight	2.8 Kg	6.2 Kg	2.8 Kg	6.2 Kg
Mounting	Wall and ceiling recessed	Wall and ceiling recessed	Wall and ceiling recessed	Wall and ceiling recessed
IP rating	IP44	IP44	IP65	IP65
Insulation class	III	III	III	III
Control gear	Constant current electronic driver (not included)	Constant current electronic driver (not included)	Constant current electronic driver (not included)	Constant current electronic driver (not included)
Cut out for plasterboard	415 x 115 mm	1050 x 115 mm	415 x 115 mm	1050 x 115 mm
Lamp type	LED ⚡ Vf: 3 VDC	LED ⚡ Vf: 3 VDC	LED ⚡ Vf: 3 VDC	LED ⚡ Vf: 3 VDC
Lamp wattage	1W - 350 mA 2W - 500 mA	1W - 350 mA 2W - 500 mA	1W - 350 mA 2W - 500 mA	1W - 350 mA 2W - 500 mA
Luminous efficacy	75 lm - 3000K 350 mA 170 lm - 3000K 500 mA	75 lm - 3000K 350 mA 170 lm - 3000K 500 mA	75 lm - 3000K 350 mA 170 lm - 3000K 500 mA	75 lm - 3000K 350 mA 170 lm - 3000K 500 mA
Light distribution	Narrow beam 14°	Narrow beam 14°	Narrow beam 14°	Narrow beam 14°
Fitting	-	-	-	-
Light colour	White 3000K White 2700K (on request)	White 3000K White 2700K (on request)	White 3000K White 2700K (on request)	White 3000K White 2700K (on request)
Light hole	370 x 45 mm	1000 x 45 mm	370 x 45 mm	1000 x 45 mm
Voltage connection	By driver (optional)	By driver (optional)	By driver (optional)	By driver (optional)
CRI	>90	>90	>90	>90
Emergency	-	-	-	-
Energy efficiency class	A++	A++	A++	A++
Note	It is possible to cut the electrified body to obtain a light hole 200 mm minimum. On request available dimmable PUSH or DALI, remote installation.	It is possible to cut the electrified body to obtain a light hole 400 mm minimum. On request available dimmable PUSH or DALI, remote installation.	It is possible to cut the electrified body to obtain a light hole 200 mm minimum. On request available dimmable PUSH or DALI, remote installation.	It is possible to cut the electrified body to obtain a light hole 400 mm minimum. On request available dimmable PUSH or DALI, remote installation.

Optional accessories on page 446

Blade IP44 / IP65

OPTIONAL ACCESSORIES

product code	optional code	description	info
6965.CW	H8350	Constant current electronic driver	Suitable for n°1 code 6965.CW - 350 mA
	H8500.B	Constant current electronic driver. Remote installation	Suitable for n°5 code 6965.CW - 500 mA
	H8500.C	Constant current electronic driver. Remote installation	Suitable for n°2 code 6965.CW - 500 mA
	BR6965LT	Brick box	Dimensions L: 490 mm; W: 110 mm; D: 85 mm (<i>instructions on page 502</i>)
6966.CW	H8350	Constant current electronic driver	Suitable for n°1 code 6966.CW - 350 mA
	H8500.B	Constant current electronic driver. Remote installation	Suitable for n°5 code 6966.CW - 500 mA
	H8500.C	Constant current electronic driver. Remote installation	Suitable for n°2 code 6966.CW - 500 mA
	BR6966LT	Brick box	Dimensions L: 1120 mm; W: 110 mm; D: 85 mm (<i>instructions on page 502</i>)
6987.CW	H8350	Constant current electronic driver	Suitable for n°1 code 6987.CW - 350 mA
	H8500.B	Constant current electronic driver. Remote installation	Suitable for n°5 code 6987.CW - 500 mA
	H8500.C	Constant current electronic driver. Remote installation	Suitable for n°2 code 6987.CW - 500 mA
	BR6987LT	Brick box	Dimensions L: 490 mm; W: 110 mm; D: 85 mm (<i>instructions on page 502</i>)
6988.CW	H8350	Constant current electronic driver	Suitable for n°1 code 6988.CW - 350 mA
	H8500.B	Constant current electronic driver. Remote installation	Suitable for n°5 code 6988.CW - 500 mA
	H8500.C	Constant current electronic driver. Remote installation	Suitable for n°2 code 6988.CW - 500 mA
	BR6988LT	Brick box	Dimensions L: 1120 mm; W: 110 mm; D: 85 mm (<i>instructions on page 502</i>)

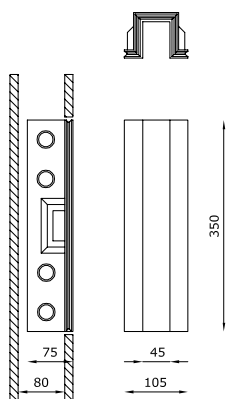

C

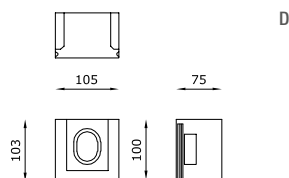

D

TECHNICAL FEATURES | MODULAR BODY

Code	6964.CW (fig. C)
Material	CW: Coral WaterOut® waterproof
Weight	2 Kg
IP rating	-
Cut out for plasterboard	(350 mm for each module installed) x 115 mm
Light hole	(350 mm for each module installed) x 45 mm
Note	-

TECHNICAL FEATURES | CLOSURE HEADPARTS

Code	6963.CW (fig. D)
Material	CW: Coral WaterOut® waterproof
Weight	0.7 Kg
IP rating	-
Cut out for plasterboard	115 x 115 mm
Light hole	-
Note	Supplied singularly it can be used in alternative to a further electrified body (code 6965.CW / 6966.CW / 6987.CW / 6988.CW) to close a continuous line of the BLADE IP44/IP65 product.

EXAMPLES OF INSTALLATION

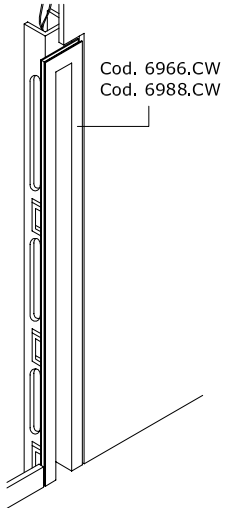
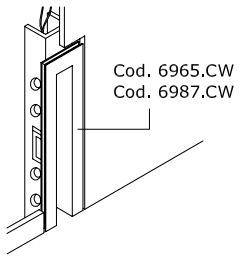

Singular module
No. 1 electrified body

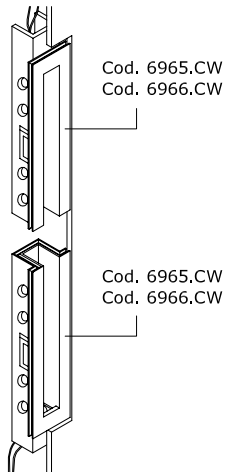

No. 2 electrified bodies
in opposite position

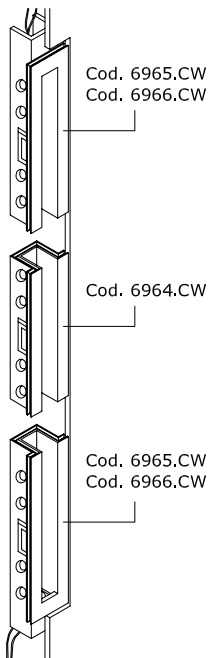

No. 2 electrified bodies
in opposite position
No. 1 modular body in Coral WaterOut®

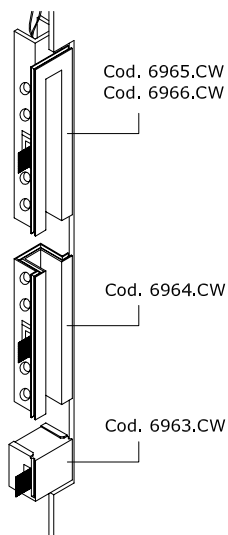

No. 1 electrified body
No. 1 modular body in Coral WaterOut®
No. 1 closure headpart







ALADIN IP65



INCASSO A PARETE E SOFFITTO CON VETRO A FILO.

Aladin IP65 è un apparecchio da esterni, incasso a scomparsa totale in Coral WaterOut®, per l'installazione a parete e soffitto di cartongesso o laterizio. Dal design pulito e minimale, si integra alla perfezione nell'ambiente in cui viene installato con l'obiettivo di esaltare le architetture e gli scenari outdoor. Il prodotto scompare, inserendosi nelle superfici, garantendo un'ottima illuminazione degli spazi esterni e delle zone umide, grazie a una luce performante che diventa protagonista dello spazio. Il vetro frontale satinato è fissato con 4 viti in policarbonato dello stesso colore del vetro.



WALL OR CEILING RECESSED FITTING WITH FLUSH GLASS.

Aladin IP65 is a totally disappearing outdoor recessed luminaire made of Coral WaterOut®, installable on plasterboard or brick walls and ceilings. With its neat and minimal design, it perfectly integrates inside the space it is installed in, enhancing architectures and outdoor landscapes. The product disappears, as it is inserted inside surfaces, ensuring a good lighting on external and moist areas, thanks to a performing light that becomes the real protagonist of the space. The front satin glass is fixed with 4 polycarbonate screws of the same colour of the glass.

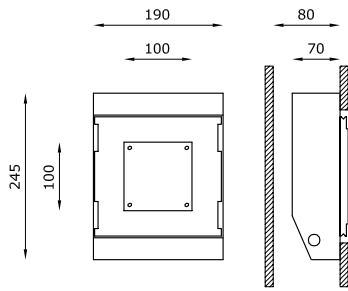



TECHNICAL FEATURES

Code	1842.CW
Type	Downlight 90° Wall recessed 90° 
Material	CW: Coral WaterOut® waterproof
Weight	1.5 Kg
Mounting	Wall and ceiling recessed
IP rating	IP65
Insulation class	III
Control gear	Constant current electronic driver
Cut out for plasterboard	195 x 185 mm
Lamp type	LED 500 mA 
Lamp wattage	1 x 9W
Luminous efficacy	1125 lm - 3000K
Light distribution	Wide beam 40°
Fitting	-
Light colour	White 3000K White 2700K 4000K (on request)
Light hole	100 x 100 mm
Voltage connection	220-240V · 50/60Hz
CRI	>90
Emergency	-
Energy efficiency class	A++
Note	Glass diffuser with 4 polycarbonate screws of the same colour of the glass. On request available dimmable PUSH or DALI.

PASSÉ IP65



SCOMPARSA TOTALE PER L'ESTERNO,
INERTE ALLA SALINITÀ.



Passé IP65 è un apparecchio da esterni, incasso a scomparsa totale per l'installazione a parete e soffitto di cartongesso o laterizio che, grazie alla sua luce, indica precisi percorsi luminosi: il flusso luminoso corre sulle pareti, crea una guida discreta dal design minimale, lo spazio si piega ai desideri della creatività, dando vita a soluzioni uniche e ricche di fascino. Grazie alla durezza tipica del DurCoral®, Passé IP65 è il prodotto ideale per l'installazione in ambienti in cui è necessaria una particolare resistenza agli agenti esterni.

*TOTAL RECESSED FITTING FOR OUTDOORS,
SALT-PROOF.*

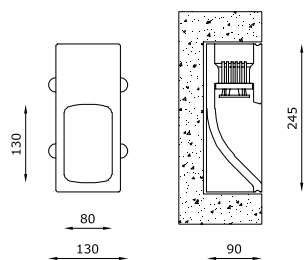
Passé IP65 is a totally disappearing outdoor recessed luminaire, installable on plasterboard or brick walls and ceilings; thanks to its light, it shows precise light paths: its luminous beam flows on the walls, creating a discreet guide with a minimal design, spaces are shaped by desires of creativity, giving life to unique and fascinating solutions. Thanks to the characteristic toughness of DurCoral®, Passé IP65 is the ideal product to install in environments where a particular resistance to external agents is required.



TECHNICAL FEATURES

Code	1508.DC
Type	Wall-washer 
Material	DC: DurCoral®
Weight	2.5 Kg
Mounting	Wall and ceiling recessed
IP rating	IP65
Insulation class	III
Control gear	Constant current electronic driver (not included)
Cut out for plasterboard	140 x 260 mm
Lamp type	LED IP65 500 mA  Vf: 9.3 VDC
Lamp wattage	1 x 5W
Luminous efficacy	117 lm/W - 3000K
Light distribution	Wide beam 70°
Fitting	-
Light colour	White 3000K White 2700K 4000K (on request)
Light hole	80 x 130 mm
Voltage connection	By driver (optional)
CRI	80 90 (on request)
Emergency	-
Energy efficiency class	A++
Note	-

OPTIONAL ACCESSORIES

<i>product code</i>	<i>optional code</i>	<i>description</i>	<i>info</i>
1508.DC	H8067IP	Constant current electronic driver	Suitable for n°1 code 1508.DC - 500 mA (IP66)



Private house - A. Castrignano - Milan



Private house - A. Castrignano - ph. E. Abrate - Rome

NUSS IP65



TECNOCEMENTO DURCORAL® INERTE AL CLORO.

Nuss IP65 è un apparecchio per esterni a parete in DurCoral® dal design pulito e lineare. Nuss IP65 è resistente a qualsiasi condizione atmosferica, crea un rapporto dialettico con gli spazi arricchendoli semplicemente con la sua presenza discreta ma decisa: può infatti integrarsi o diventare protagonista a seconda delle esigenze. Un apparecchio a biemissione in cui tecnologia e design minimale si fondono in un prodotto dalle performance illuminotecniche uniche, in grado di fondersi perfettamente negli ambienti in cui viene installato, trasformando la luce in protagonista assoluta. Nuss IP65 ha un'anima interna in alluminio pressofuso, un diffusore in vetro satinato, oltre a guarnizioni in silicone e viti interne in acciaio inox che lo rendono ideale per ambienti esterni.

DURCORAL® TECHNO-CEMENT, CHLORINE-PROOF.

Nuss IP65 is a wall lighting device for outdoor use made of DurCoral® with a clean and linear design. Nuss IP65 is resistant to any atmospheric conditions, and creates a dialectic relationship with spaces, enhancing them with its discreet yet precise presence. In fact, it is able to integrate in or to become a protagonist, depending on the various needs. A bi-emission luminaire in which technology and minimal design merge in a product with unique illumination-engineering performances, it perfectly mingles with the environments it is installed in, transforming light into an absolute protagonist. Nuss IP65 has an internal soul of die-cast aluminium, a satin-glass diffuser, silicone gaskets and internal inox-steel screws which make it the ideal product for outdoor environments.

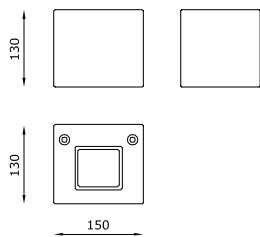

TECHNICAL FEATURES

Code	3061.DC	3062.DC
Type	Wall lamp 	Wall lamp 
Material	DC: DurCoral®	DC: DurCoral®
Weight	3.1 Kg	3.1 Kg
Mounting	Wall mounting	Wall mounting
IP rating	IP65	IP65
Insulation class	III	I
Control gear	-	-
Cut out for plasterboard	-	-
Lamp type	LED 	QT-14 
Lamp wattage	2 x 4W	1 x 60W
Luminous efficacy	2 x 400 lm	-
Light distribution	Wide beam 120°	-
Fitting	-	G9
Light colour	White 3000K White 4000K (on request)	-
Light hole	-	-
Voltage connection	220-240V · 50/60Hz	220-240V · 50/60Hz
CRI	90	-
Emergency	-	-
Energy efficiency class	A++	A
Note	Extra white frosted glass diffuser. Aluminum reflector. No transformer is required, direct operation at 220-240V.	Extra white frosted glass diffuser. Aluminum reflector.



MINIVIRTUS IP65



TECNOCEMENTO DURCORAL® INERTE
AGLI AGENTI ATMOSFERICI.



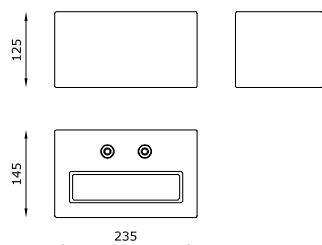

Minivirtus IP65 apparecchio da esterni a parete in DurCoral®. Grazie a un design discreto ed elegante, sa impreziosire i dettagli architettonici degli edifici, valorizzandone ogni caratteristica e particolare. Una applique a biemissione, che dipinge e plasma con la luce sulle pareti, rompendo l'oscurità per abbracciare ed esaltare gli ambienti, in una perfetta sintesi di estetica e tecnologia avanzata. Minivirtus IP65 ha un'anima interna in alluminio pressofuso, un diffusore in vetro satinato, oltre a guarnizioni in silicone e viti interne in acciaio inox che lo rendono ideale per ambienti esterni.

*DURCORAL® TECHNO-CEMENT,
WEATHER-PROOF.*

Minivirtus IP65 is an outdoor wall luminaire made of DurCoral®. Thanks to its discreet and elegant design, it is able to enhance the architectural details of buildings, highlighting every single characteristic and feature. A bi-emission applique, it paints and shapes light on walls, breaking into darkness to embrace and exalt spaces in a perfect synthesis of aesthetics and advanced technology. Minivirtus IP65 has an internal soul in die-cast aluminium, a satin-glass diffuser, silicone gaskets and internal inox-steel screws which make it the ideal product for outdoor environments.



TECHNICAL FEATURES

Code	3044.DC	3046.DC
Type	Wall lamp 	Wall lamp 
Material	DC: DurCoral®	DC: DurCoral®
Weight	4.7 Kg	4.7 Kg
Mounting	Wall mounting	Wall mounting
IP rating	IP65	IP65
Insulation class	I	I
Control gear	Conventional ballast	Constant voltage LED driver
Cut out for plasterboard	-	-
Lamp type	TC-D 	LED 24V 
Lamp wattage	1 x 26W	2 x 10W
Luminous efficacy	-	2 x 1400 lm
Light distribution	-	Wide beam 120°
Fitting	G24d-3	-
Light colour	-	White 3000K White 2700K 4000K (on request)
Light hole	-	-
Voltage connection	220-240V · 50/60Hz	220-240V · 50/60Hz
CRI	-	>80
Emergency	-	-
Energy efficiency class	A	A++
Note	Extra white frosted glass diffuser. Aluminum reflector.	Extra white frosted glass diffuser. Aluminum reflector.

Minivirtus IP65





Private house - Arch. C. Spagnotto - Turin

VIRTUS IP65



TECNOCEMENTO DURCORAL® INERTE ALLA SALINITÀ.

Virtus IP65 è un apparecchio per esterni a parete a biemissione realizzato in DurCoral®. Lo contraddistinguono linearità, semplicità ed eleganza: un prodotto che sa impresiosire i dettagli architettonici degli edifici, valorizzandone ogni caratteristica e particolare. Un apparecchio che accende gli spazi esterni creando atmosfere delicate e rilassanti, delineate da una forma geometrica lineare e pura.

Una applique a biemissione, che dipinge con la luce sulle pareti, rompendo l'oscurità per abbracciare ed esaltare gli ambienti, in una perfetta sintesi di estetica e tecnologia avanzata. Virtus IP65 ha un'anima interna in alluminio pressofuso, un diffusore in vetro satinato, oltre a guarnizioni in silicone e viti interne in acciaio inox che lo rendono ideale per ambienti esterni.

DURCORAL® TECHNO-CEMENT, SALT-PROOF.

Virtus IP65 is a wall lighting device for outdoor use made of DurCoral®. It is characterized by linearity, simplicity and elegance: a product able to beautify architectural details on buildings, enhancing every single particular. A luminaire that lights up external spaces, creating delicate and relaxing atmospheres, outlined by a linear and pure geometrical shape. A bi-emission applique, that paints and plays with light on walls, breaking the darkness to embrace and exalt spaces, in a perfect synthesis of aesthetics and advanced technology.

Virtus IP65 has an internal soul in die-cast aluminium, a satin-glass diffuser, silicone gaskets and internal inox-steel screws which make it the ideal product for outdoor environments.

Outdoor

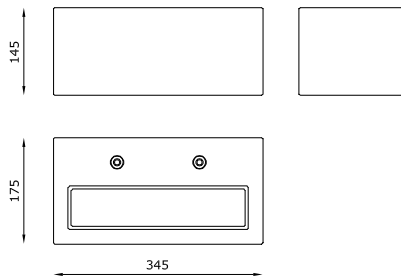

TECHNICAL FEATURES

Code	3054.54.DC	3058.58.DC
Type	Wall lamp 	Wall lamp 
Material	DC: DurCoral®	DC: DurCoral®
Weight	8.3 Kg	8.3 Kg
Mounting	Wall mounting	Wall mounting
IP rating	IP65	IP65
Insulation class	I	I
Control gear	Conventional ballast	Constant voltage LED driver
Cut out for plasterboard	-	-
Lamp type	TC-D 	LED 24V 
Lamp wattage	2 x 26W	2 x 13W
Luminous efficacy	-	2 x 1700 lm
Light distribution	-	Wide beam 120°
Fitting	G24d-3	-
Light colour	-	White 3000K White 2700K 4000K (on request)
Light hole	-	-
Voltage connection	220-240V · 50/60Hz	220-240V · 50/60Hz
CRI	-	>80
Emergency	-	-
Energy efficiency class	A	A++
Note	Extra white frosted glass diffuser. Aluminum reflector.	Extra white frosted glass diffuser. Aluminum reflector.



MINIVIRTUS DIRECT IP65



TECNOCEMENTO DURCORAL® INERTE AL CLORO.



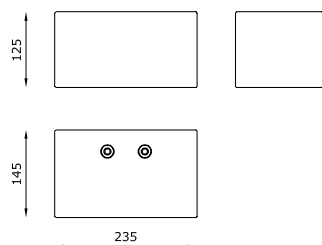

Minivirtus Direct IP65 è un apparecchio da esterni a parete dal design pulito, elegante, lineare: una applique che parla di purezza, di forme e di luce che, insieme alle caratteristiche del materiale DurCoral®, danno vita a soluzioni uniche perfettamente in grado di integrarsi con l'ambiente esterno. Una luce diretta che crea precise atmosfere luminose lungo i percorsi, i punti di accesso e le facciate degli edifici su cui il prodotto viene installato. Minivirtus Direct IP65 ha un'anima interna in alluminio pressofuso, un diffusore in vetro satinato, oltre a guarnizioni in silicone e viti interne in acciaio inox che lo rendono ideale per ambienti esterni.

DURCORAL® TECHNO-CEMENT, CHLORINE-PROOF.

Minivirtus Direct IP65 is an outdoor wall luminaire with a neat, elegant and linear design: an applique that speaks of purity, shapes and light which, together with the features of DurCoral®, give life to unique solutions able to perfectly integrate themselves inside the external environment. A direct light that creates precise bright atmospheres alongside paths, access points and façades of the buildings it is installed on. Minivirtus Direct IP65 has an internal soul in die-cast aluminium, a satin-glass diffuser, silicone gaskets and internal inox-steel screws which make it the ideal product for outdoor environments.



TECHNICAL FEATURES

Code	3074.DC	3078.DC
Type	Wall lamp 	Wall lamp 
Material	DC: DurCoral®	DC: DurCoral®
Weight	5 Kg	5 Kg
Mounting	Wall mounting	Wall mounting
IP rating	IP65	IP65
Insulation class	I	I
Control gear	Conventional ballast	Constant voltage LED driver
Cut out for plasterboard	-	-
Lamp type	TC-D 	LED 24V 
Lamp wattage	1 x 26W	1 x 10W
Luminous efficacy	-	1400 lm
Light distribution	-	Wide beam 120°
Fitting	G24d-3	-
Light colour	-	White 3000K White 2700K 4000K (on request)
Light hole	-	-
Voltage connection	220-240V · 50/60Hz	220-240V · 50/60Hz
CRI	-	>80
Emergency	-	-
Energy efficiency class	A	A++
Note	Extra white frosted glass diffuser. Aluminum reflector.	Extra white frosted glass diffuser. Aluminum reflector.



VIRTUS DIRECT IP65



TECNOCEMENTO E ALLUMINIO PER RESISTENZA NEL TEMPO.

Virtus Direct IP65 è un apparecchio per esterni a parete dal design elegante, lineare: un'applicque che parla di purezza, di forme e di luce che, insieme alle caratteristiche del materiale DurCoral®, danno vita a soluzioni uniche in grado di integrarsi con l'ambiente esterno. Una luce diretta, che crea precise atmosfere luminose lungo i percorsi, i punti di accesso e le facciate degli edifici su cui il prodotto viene installato.

L'illuminazione definisce gli spazi, si pone al servizio dei materiali, dei volumi, dei colori, consente di percepire gli ambienti e di vivere, ogni volta, emozioni diverse. Virtus Direct IP65 ha un'anima interna in alluminio pressofuso, un diffusore in vetro satinato, oltre a guarnizioni in silicone e viti interne in acciaio inox che lo rendono ideale per ambienti esterni.

TECHNO-CEMENT AND ALUMINIUM FOR LONG-LASTING RESISTANCE.

Virtus Direct IP65 is a wall lighting device for outdoor use with an elegant and linear design: an applique that speaks of purity, shapes and light which, together with the features of DurCoral®, give life to unique solutions able to perfectly integrate themselves inside the external environment. A direct light that creates precise bright atmospheres alongside paths, access points and façades of the buildings it is installed on. Lighting defines spaces, putting itself at the service of materials, volumes, colours, allowing the perception of spaces and ever different emotions. Virtus Direct IP65 has an internal soul in die-cast aluminium, a satin-glass diffuser, silicone gaskets and internal inox-steel screws which make it the ideal product for outdoor environments.

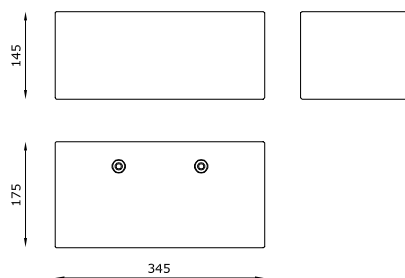

TECHNICAL FEATURES

Code	3064.64.DC	3068.68.DC
Type	Wall lamp 	Wall lamp 
Material	DC: DurCoral®	DC: DurCoral®
Weight	8.6 Kg	8.6 Kg
Mounting	Wall mounting	Wall mounting
IP rating	IP65	IP65
Insulation class	I	I
Control gear	Conventional ballast	Constant voltage LED driver
Cut out for plasterboard	-	-
Lamp type	TC-D 	LED 24V 
Lamp wattage	2 x 26W	1 x 13W
Luminous efficacy	-	1700 lm
Light distribution	-	Wide beam 120°
Fitting	G24d-3	-
Light colour	-	White 3000K White 2700K 4000K (on request)
Light hole	-	-
Voltage connection	220-240V · 50/60Hz	220-240V · 50/60Hz
CRI	-	>80
Emergency	-	-
Energy efficiency class	A	A++
Note	Extra white frosted glass diffuser. Aluminum reflector.	Extra white frosted glass diffuser. Aluminum reflector.

THE NUDE



TECNOCEMENTO TRASPARENTE.

The nude coniuga La forza e la resistenza del cemento e la trasparenza del vetro temprato. Il risultato è un bollard con luce a 360°, che nasconde nella purezza delle sue forme un prodotto adatto ad installazioni anche tra le più gravose grazie alla sua elevatissima resistenza meccanica, all'abrasione, alla resistenza ai raggi UV, al cloro e al sale. The Nude è costruito con un innovativo cemento trasparente, materiale brevettato ed esclusivo, frutto del reparto di Ricerca e Sviluppo di Italcementi; già utilizzato con successo presso Padiglione Italia Expo di Shanghai.

TRANSPARENT TECHNO-CEMENT.

The Nude combines the strength and resistance of concrete and the transparency of tempered glass. The result is a bollard with 360° light emission, which pure shapes hide a product suitable for even the most onerous installations thanks to its high mechanical, abrasion, UV rays, chlorine and salt resistance. The Nude is built with an innovative transparent cement, exclusive patented material, the result of the Research & Design department of Italcementi, already successfully used at the Italian Expo Pavilion of Shanghai.

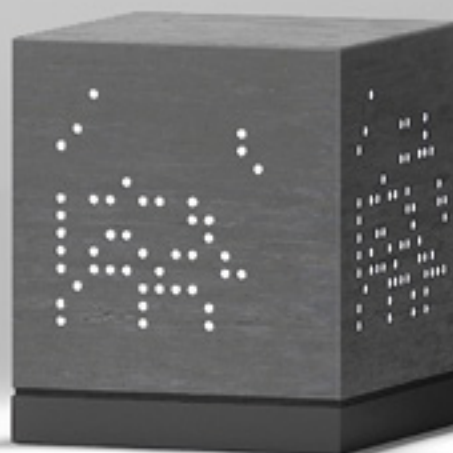

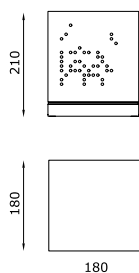

CODE COMPOSITION



1729.DC 4 S 00 E _ WD

light colour

27	2700K
30	3000K
40	4000K

example of code composition 1729.DC 4 S 00 E **30** WD

TECHNICAL FEATURES

Code	1729.DC XX
Type	Ground lamp 
Material	DC: DurCoral®
Weight	-
Mounting	Ground lamp
IP rating	IP65
Insulation class	III
Control gear	Constant current driver (not included)
Cut out for plasterboard	-
Lamp type	LED 250 mA  Vf: 23.5 VDC
Lamp wattage	1 x 6W
Luminous efficacy	900 lm - 3000K
Light distribution	360°
Fitting	-
Light colour	White 3000K White 2700k (on request)
Light hole	194 x Ø 5 mm
Voltage connection	By driver (optional)
CRI	90
Emergency	-
Energy efficiency class	A++
Note	-

OPTIONAL ACCESSORIES

<i>product code</i>	<i>optional code</i>	<i>description</i>	<i>info</i>
1729.DC XX	H8300.A	Constant current electronic driver. Remote installation	Suitable for n°1 code 1729.DC XX - 250 mA

The Nude



SUPERFUTUREDESIGN™



UNDERLINE



PIASTRELLA LUMINOSA IN TECNOCEMENTO DURCORAL®.

Alto indice di protezione da agenti esterni per Underline, apparecchio da terra calpestabile, ideale per installazioni all'aperto, grazie al grado di protezione IP68.

Una luce integrata nella pavimentazione, dal design geometrico realizzata in DurCoral®, l'innovativo brevetto Buzzi & Buzzi che ha resistenza meccanica superiore al calcestruzzo ed è quindi in grado di integrarsi con qualsiasi pavimentazione. Con 5.5W di potenza LED, questo apparecchio non solo è un ottimo segnapasso, ma permette anche di valorizzare gli spazi outdoor.

LUMINOUS TILE IN DURCORAL® TECHNO-CEMENT.

High protection index from external agents for Underline, the ground walkable luminaire, ideal for outdoor installations, thanks to its IP68 level of protection.

A light built into the paving, with a geometrical design made in DurCoral®, the innovative Buzzi & Buzzi patent with a mechanical strength higher than concrete and can therefore be built into any type of paving. With a LED power of 5.5W, this luminaire is not only an excellent footpath light, but can be also used to enhance outdoor areas.

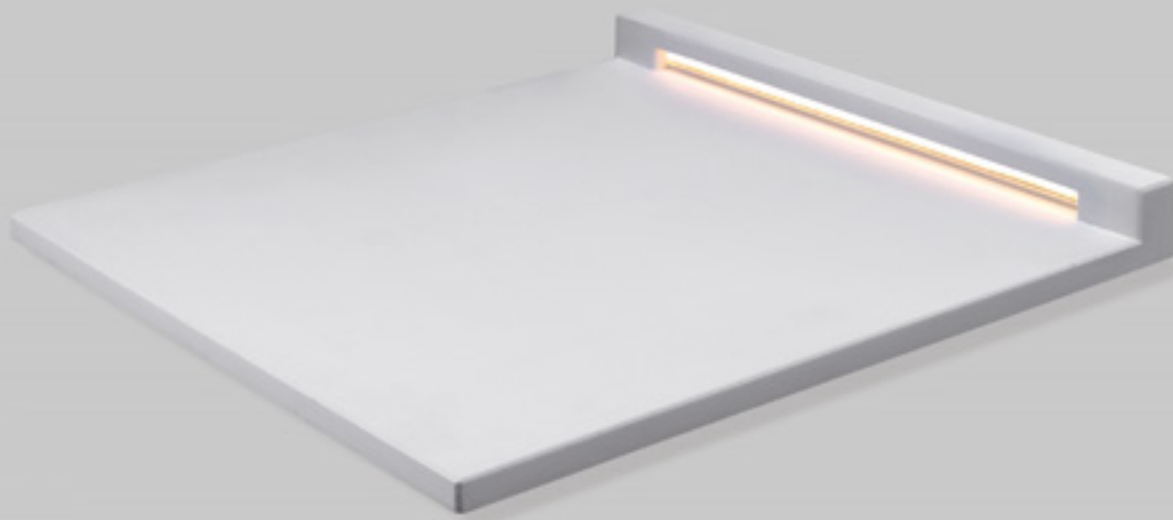

LUCE INTEGRATA NELLA PAVIMENTAZIONE

LIGHT INTEGRATED
IN THE PAVING

può essere appoggiato
direttamente sul terreno (senza
scavi) oppure incollato su un
basamento preesistente

*it can be rested directly on the
ground (without excavations) or
glued onto a pre-existing base*

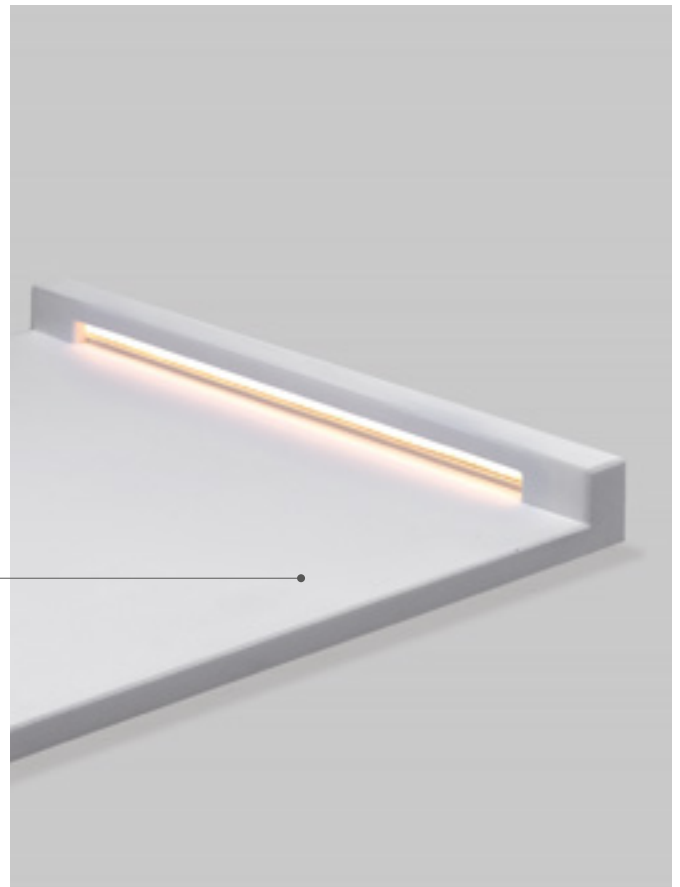

IP68

alto indice di protezione
da agenti esterni

*high protection index
from external agents*

INSTALLATION

installazione sopra il terreno / *installation above the ground*

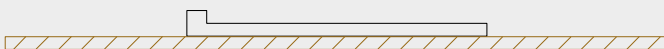

Underline è pedonabile
Underline is walkable

installazione a filo terreno / *installation level with the ground*

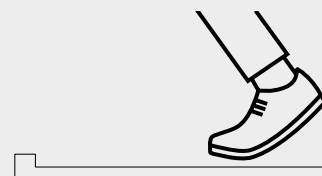
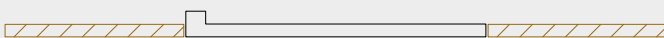

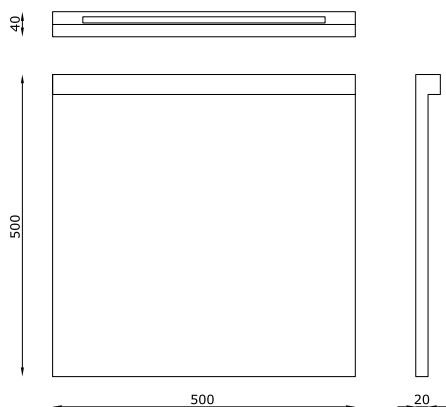

Underline



CODE COMPOSITION

1741.DC

TECHNICAL FEATURES

Code	1741.DC
Type	Ground lamp 
Material	DC: DurCoral®
Weight	11 Kg
Mounting	Ground lamp
IP rating	IP68
Insulation class	II
Control gear	Remote constant voltage driver (not included)
Lamp type	LED 24V 
Lamp wattage	1 x 5.5W
Luminous efficacy	40 lm/W - 3000K
Light distribution	Wide beam 120°
Fitting	-
Light colour	White 3000K
Light hole	400 x 15 mm
Voltage connection	By driver (optional)
CRI	90
Emergency	-
Energy efficiency class	A++
Note	On request available dimmable PUSH or DALI, remote installation.

OPTIONAL ACCESSORIES

<i>product code</i>	<i>optional code</i>	<i>description</i>	<i>info</i>
1741.DC	H8024.D	Constant voltage driver. Remote installation	Suitable for n°3 code 1741.DC - 24V



SUPERFUTUREDESIGN®

UNDERScore



TECNOCEMENTO INTERRABILE.

Underscore è una perfetta unione di concetti e forme. Apparecchio per esterni in DurCoral® con grado di protezione IP68, capace di garantire una perfetta resistenza meccanica in caso di umidità e usura da agenti esterni.

Una linea di luce, un fascio che definisce i percorsi in maniera variabile in base alla tipologia di installazione; il prodotto, infatti, può avere un'altezza di 200 mm se tenuto a superficie, ma che offre la possibilità di essere modificata fino ad uno sviluppo verticale fuori terra di 80 mm, nel caso in cui l'apparecchio fosse interrato.

TECHNO-CEMENT WHICH CAN BE BURIED IN THE GROUND.

Underscore is the perfect combination of concepts and shapes. This outdoor device made of DurCoral®, with IP68 protection scale, provides impeccable mechanical resistance to humidity and external agents.

A boundary of light, a beam that marks paths in many different ways, depending on the type of installation; in fact, the product can be 200 mm (7.87") high when placed on the surface, but it can also be vertically extended by 80 mm (3.15"), when the device is underground.

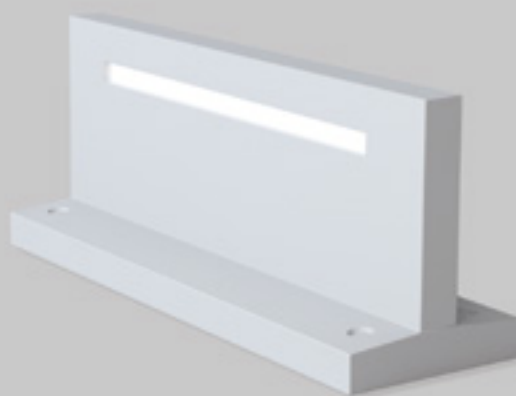

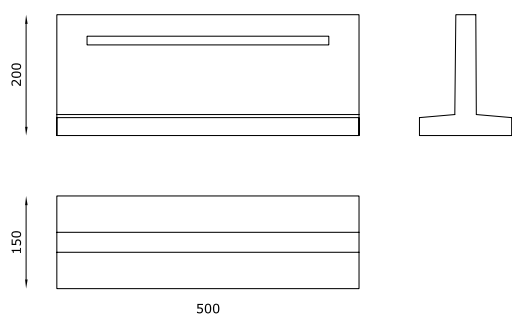



CODE COMPOSITION

1751.DC

TECHNICAL FEATURES

Code	1751.DC
Type	Ground lamp 
Material	DC: DurCoral®
Weight	11 Kg
Mounting	Ground lamp
IP rating	IP68
Insulation class	III
Control gear	Remote constant voltage driver (not included)
Lamp type	LED 24V 
Lamp wattage	1 x 5.5W
Luminous efficacy	40 lm/W - 3000K
Light distribution	Wide beam 120°
Fitting	-
Light colour	White 3000K
Light hole	400 x 15 mm
Voltage connection	By driver (optional)
CRI	90
Emergency	-
Energy efficiency class	A++
Note	On request available dimmable. PUSH or DALI, remote installation.



OPTIONAL ACCESSORIES

<i>product code</i>	<i>optional code</i>	<i>description</i>	<i>info</i>
1751.DC	H8024.D	Constant voltage driver. Remote installation	Suitable for n°3 code 1751.DC - 24V



SUPERFUTUREDESIGN™



Design

Carlo Colombo

VALO IP65



TECNOCEMENTO: RESISTENZA E LUMINOSITÀ AI MASSIMI LIVELLI.

Ingegneria, innovazione e tecnica si sposano per dare vita a Valo IP65, una lampada da terra per esterni e interni in DurCoral® che, grazie alle sue caratteristiche estetiche e tecniche e al suo design accattivante e innovativo, si integra in modo discreto nello spazio in cui viene installata. Attraverso la luce, che enfatizza i dettagli, Valo IP65 regala nuova vita agli ambienti, illuminando arredi e architetture, valorizzando terrazzi, vialetti di ingresso e giardini, con un preciso obiettivo: creare scenografie luminose dallo stile e dal design inconfondibile.

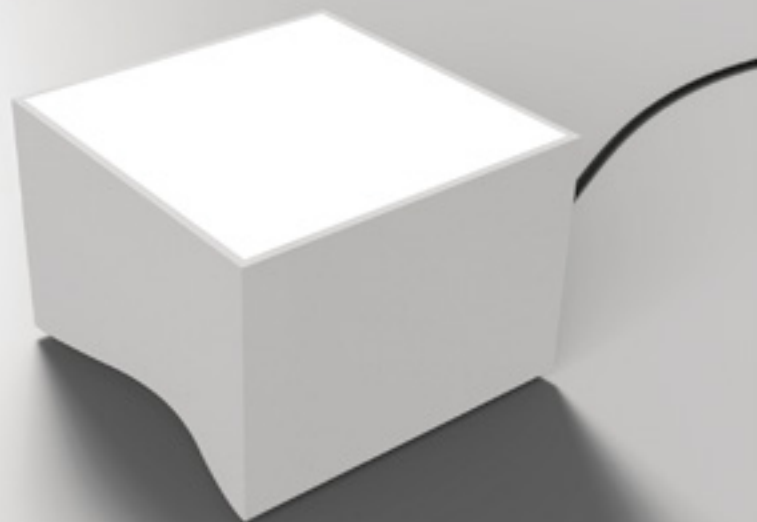

TECHNO-CEMENT: RESISTANCE AND LUMINOSITY AT MAXIMUM LEVELS.

Engineering, innovation and technique get together to give life to Valo IP65, a floor lighting device for indoor and outdoor use made of DurCoral®. Thanks to its aesthetic and technical features and its charming and innovative design, it integrates itself in a discreet way in the space where it is installed. Through light, Valo IP65 enhances details, giving new life to spaces, highlighting furnitures and architectures, valorizing terraces, walkways and gardens, with the precise aim: to create light settings of unique style and design.

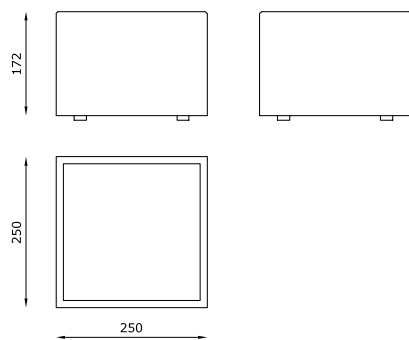



TECHNICAL FEATURES

Code	1624.DC
Type	Ground lamp 
Material	DC: DurCoral®
Weight	7.5 Kg
Mounting	Ground lamp
IP rating	IP65
Insulation class	II
Control gear	-
Cut out for plasterboard	-
Lamp type	LED 
Lamp wattage	1 x 18W
Luminous efficacy	89 lm/W - 3000K
Light distribution	Wide beam 120°
Fitting	-
Light colour	White 3000K White 2700K (on request)
Light hole	-
Voltage connection	220-240V - 50/60Hz
CRI	85
Emergency	-
Energy efficiency class	A++
Note	Supported glass in satin white 12 mm.





Design

Andrea Sensoli

THE BOLLARD



BOLLARD IN TECNOCEMENTO CON ALTEZZA PERSONALIZZABILE.

The Bollard è un apparecchio da terra nero opaco, minimale e compatto. Grazie al corpo in DurCoral® di colore grigio e alla resistenza della struttura, The Bollard è ideale per gli ambienti esterni. L'altezza del palo è totalmente customizzabile, mentre il corpo è decorabile con qualsiasi tipo di pittura, in modo da potersi integrare in qualsiasi ambientazione ed è perfetto per definire percorsi tramite la luce in spazi esterni. Una lampada che crea scenografie precise e suggestive, mai invadenti.

BOLLARD IN TECHNO-CEMENT WITH CUSTOMISABLE HEIGHT.

The Bollard is an opaque-black floor lamp with a compact and minimal design. Thanks to its grey DurCoral® body and to its structure resistance, The Bollard is suitable for outdoor environments. The pole height is totally customizable, while the body can be decorated with any types of paintings in order to merge with all kinds of environments. The perfect product for tracing paths through light in outdoor spaces, a never intrusive lamp which creates precise and suggestive luminescent settings.



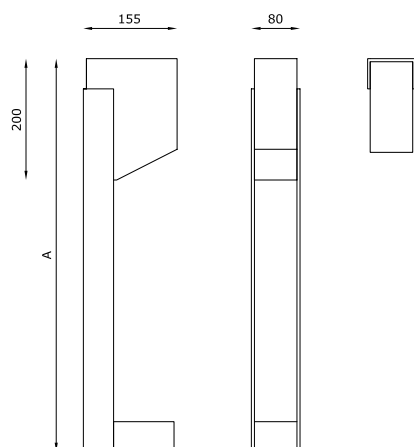

TECHNICAL FEATURES

Code	1731.DC
Type	Ground lamp 
Material	DC: DurCoral® and steel
Weight	6 Kg
Mounting	Ground lamp
IP rating	IP65
Insulation class	III
Control gear	Constant current electronic driver
Cut out for plasterboard	-
Lamp type	LED IP65 500 mA 
Lamp wattage	1 x 5W
Luminous efficacy	117 lm/W - 3000K
Light distribution	Wide beam 70°
Fitting	-
Light colour	White 3000K White 2700K 4000K (on request)
Light hole	Ø 50 mm
Voltage connection	220-240V - 50/60Hz
CRI	80 90 (on request)
Emergency	-
Energy efficiency class	A++
Note	Su richiesta si realizzano misure palo "A" da 400 a 1200 mm

The Bollard



SUPERFUTUREDESIGN™



Design

Carlo Colombo

MOND IP65



CORPO IN DURCORAL® MOLTO PIÙ FORTE
DEL CEMENTO ARMATO.

Mond IP65 è un apparecchio per esterni da terra caratterizzato da linee uniche e accattivanti: un incontro perfetto tra tecnica e design in grado di regalare un'atmosfera dal fascino discreto ed elegante agli ambienti. Un impatto visivo dal design inconfondibile per un'illuminazione performante diffusa a 180°, attraverso un vetro satinato di spessore 12 mm, che grazie anche al materiale DurCoral® con cui è realizzato, si inserisce perfettamente negli ambienti esterni.



*STRUCTURE IN DURCORAL MUCH STRONGER
THAN REINFORCED CONCRETE.*

Mond IP65 is a floor lighting device for outdoor use, characterized by unique and captivating lines: a perfect combination of technique and design, Mond IP65 is able to give an atmosphere of discreet and elegant appeal to the environment. A visual impact with a unique design for a performing 180° diffused lighting through 12mm-thick satin glass. The product perfectly integrates itself with the outdoor spaces thanks to DurCoral® material.

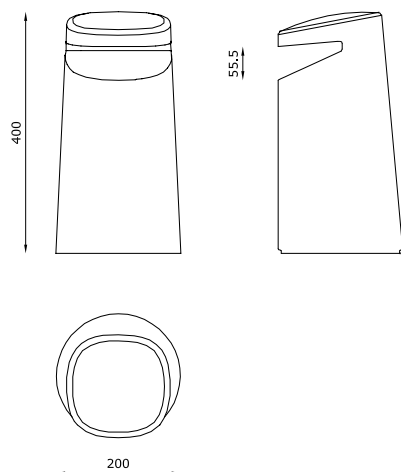



TECHNICAL FEATURES

Code	1728.DC
Type	Ground lamp 
Material	DC: DurCoral®
Weight	12 Kg
Mounting	Ground lamp
IP rating	IP65
Insulation class	II
Control gear	-
Cut out for plasterboard	-
Lamp type	LED 
Lamp wattage	1 x 18W
Luminous efficacy	89 lm/W - 3000K
Light distribution	Wide beam 120°
Fitting	-
Light colour	White 3000K White 2700K (on request)
Light hole	-
Voltage connection	220-240V - 50/60Hz
CRI	85
Emergency	-
Energy efficiency class	A++
Note	Supported glass in satin white 12 mm.

Mond IP65



Private villa - Milan



Private villa - Milan

How to read the catalogue

nome prodotto
product name

certificazioni
certifications

disegno quotato in mm
drawing quoted in mm

sezione
section

MARKUS

CE V E

SYSTEM MODULARE PER CREARE CANALI DI LUCE

Markus è un sistema modulare da parete in PVC colorato e componibile. Ideale per corridoi in ACQUAFIX per l'installazione in parete a soffitto di cartongesso o metallo che si compone nello spazio dando vita a un sistema di luce continua, un modo luminoso che dà carattere agli spazi. Il modo di integrarlo in un muro è invisibile e armonico.

MODULAR SYSTEM TO CREATE CHANNELS OF LIGHT

Markus is a wall-depending continuous modular indoor system made of ACQUAFIX modules on plasterboard or metal walls and ceiling. The unique look in the space giving life to a continuous chain of light, a light mood that gives character to all spaces, creating unique where light takes the mark.

In its way, space becomes matter & is moulded by the mark of the designer. Light becomes a channel of pure emotion.



Recessed

TECHNICAL FEATURES | ELECTRIFIED BODY

Code	8800AC 10-0	88000AC 10-0
Type	Recessed 10" 100mm recessed 10"	Recessed 10" 100mm recessed 10"
Material	ACQUAFIX®	ACQUAFIX®
Max. depth available*	5.00 cm	5.00 cm
Height	1.00 cm	1.00 cm
Mounting	Wall and ceiling recessed	Wall and ceiling recessed
IP rating	IP20	IP20
Modular color	-	-
Color light	Selectable colorless (white)	Selectable color
Light power (max.)	100 x 100 mm	100 x 100 mm
Length	600	600
Light output	1 x 100W	1 x 100W
Light distribution	Wide beam 120°	Wide beam 120°
Light color	White (2700K - 3000K or request)	-
Light size	100 x 100 mm	100 x 100 mm
Light installation	Wall and ceiling	Wall and ceiling
IP	IP20	IP20
Dimensions	60	60
Energy efficiency class	A	A
Note	*Maximum depth of installation depends on the wall and ceiling material.	

descrizione prodotto
product description

informazioni tecniche
technical features

nome prodotto
product name

disegno quotato in mm
drawing quoted in mm

sezione
section



Markus

Recessed



TECHNICAL FEATURES | MODULAR BODY

Code	8888-AL-01-01
Material	Al. Anodizzato
Dimensioni (mm)	1120 x 400
Spessore	10 mm
Colore	Grigio
Caratteristiche	1000 mm for each module installed in 100 mm
Light kit	1000 mm for each module installed in 100 mm
Note	

TECHNICAL FEATURES | CLOSURE HEADRITS

Code	8888-AL-01-01
Material	Al. Anodizzato
Dimensioni (mm)	1120 x 400
Spessore	10 mm
Colore	Grigio
Light kit	1000 mm
Note	Light kit separate from the main product. It is not included in the price. It is available from the 8888-AL-01-01 product.

EXAMPLES OF INSTALLATION

Note: For each 8888-AL-01-01 module, a maximum of 1000 mm is allowed for the

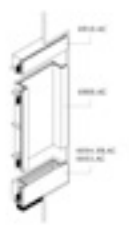

- 1. 1000 mm
- 2. 1000 mm
- 3. 1000 mm

The installation must be carried out according to the instructions provided. The final result is the responsibility of the installer.

www.buzzi-buzzi.it | 250

250 | 44

ispirazione
inspiration

esempio installazione
installation example

Mounting instruction for concrete/brick housing

CASSAFORMA PER CALCESTRUZZO/LATERIZIO
CONCRETE/BRICK HOUSING

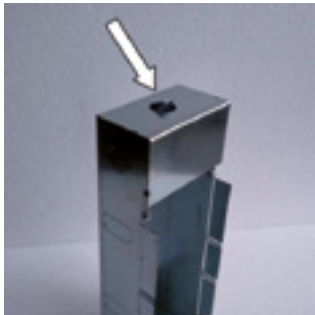
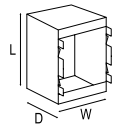

1
Rimuovere il blocco per il passaggio del corrugato.
Remove the block for the passage of the corrugates tube.

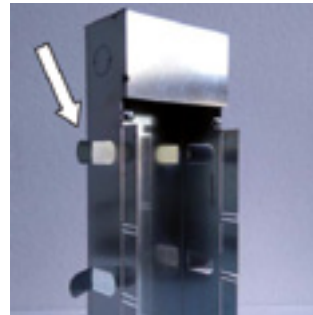

2
Allargare verso l'esterno le quattro zanche laterali.
Open out the four side anchors.

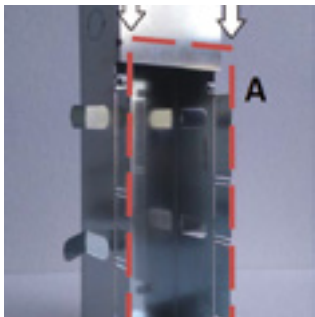

3
Murare la cassa fino a filo bordo "A" che rappresenta il livello finale dell'incasso Buzzi & Buzzi una volta installato.
Install the case in the wall up to the edge "A" that is the final level of the product once installed.

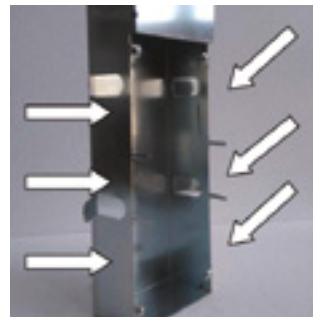

4
Quando la cassaforma è murata, rimuovere i bordi laterali.
When the cases is installed, remove the side edges.

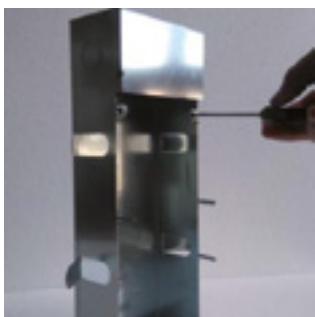

5
Regolare le viti per mettere in bolla l'incasso Buzzi & Buzzi.
Adjust the screws to level the product.



6
Inserire il corpo del prodotto.
Insert the body of the product inside the metal box.



7
Bloccare il prodotto con le flange piegandole sulla staffa microforata.
Lock the product with the flanges bending them on the bracket.

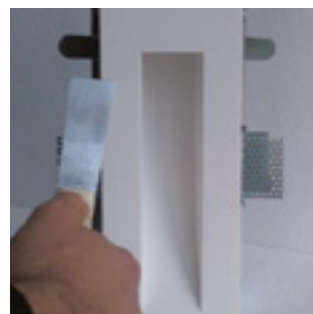

8
Procedere con la rasatura/finitura.
Proceed with the finish.

Mounting instruction for plasterboard

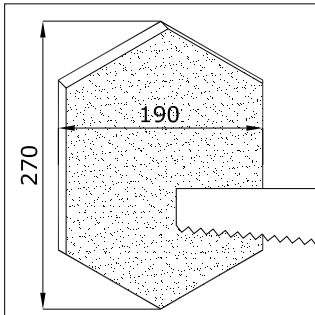

1
Forare il cartongesso.
Cut the plasterboard surface.

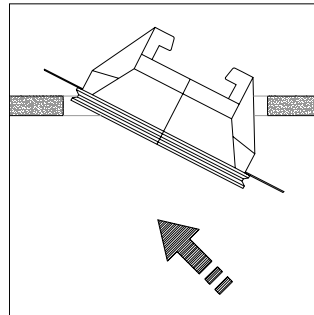

2
Inserire l'incasso in AirCoral®.
Insert the AirCoral® body.

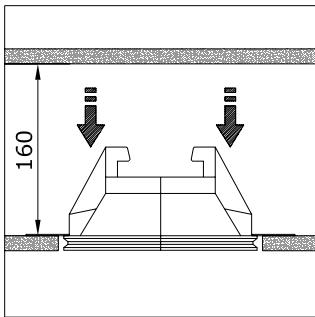

3
Posizionare l'incasso in AirCoral®
in appoggio sul cartongesso.
*Place the AirCoral® body onto
the plasterboard surface.*

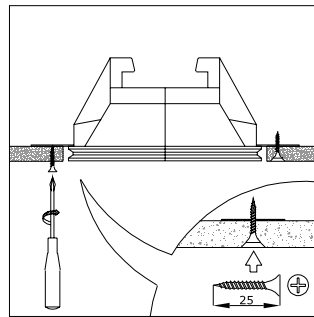

4
Fissare il prodotto con viti autofilettanti in
corrispondenza delle alette microforate.
*Fix the product with self-tapping screws right
at the level of the micro-perforated wings.*

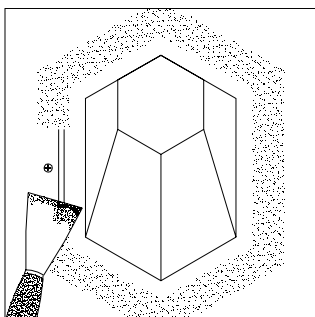

5
Stuccare e rasare il prodotto
Plaster and putty the product.

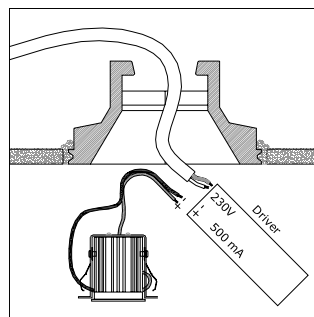

6
Collegare la parte elettrica
Connect the electrical part.

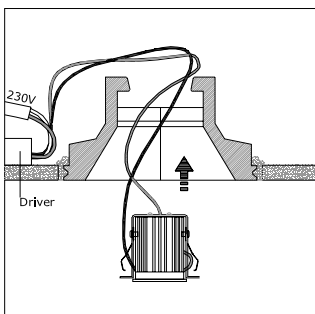

7
Inserire la parte elettrica.
Insert the electrical part.

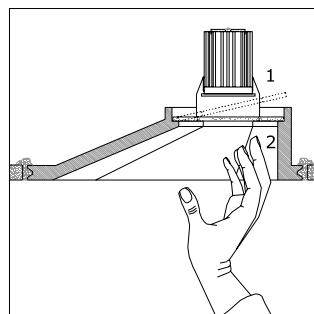

8
Posizionare il vetro.
Place the glass.

General information





Le apparecchiature illustrate in questo catalogo, sono state progettate e costruite in conformità alle vigenti normative nazionali ed internazionali. Tutti gli apparecchi sono realizzati in conformità alle Direttive comunitarie EEC 73/23 LVD – EEC 89/336 EMC – EEC 93/68 CE Mark e muniti di marcatura **CE**.

*The luminaires described in this catalogue have been designed and built in compliance with the applicable local and international regulations. All the luminaires have been built in conformity with the EEC 73/23 LVD – EEC 89/336 EMC – EEC 93/68 CE Mark European directives and provided with **CE** Mark.*



GRADO DI PROTEZIONE PROTECTION GRADE

corpi solidi (prima cifra) <i>solid bodies (first numeral)</i>		corpi liquidi (seconda cifra) <i>liquids (second numeral)</i>	
0_	Non protetto <i>No protection</i>	_0	Non protetto <i>No protection</i>
1_	Protetto da solidi superiori a \varnothing 50 mm <i>Protection against solid bodies larger than \varnothing 50 mm</i>	_1	Protetto dalla caduta verticale di gocce di acqua <i>Protected against vertically falling water drops</i>
2_	Protetto da solidi superiori a \varnothing 12 mm <i>Protection against solid bodies larger than \varnothing 12 mm</i>	_2	Protetto dalla caduta di gocce di acqua con involucro inclinato max 15° <i>Protected against vertically falling water drops when enclosure is tilted up to 15°</i>
3_	Protetto da penetrazione di sonda con \varnothing superiore a 2,5 mm <i>Protection against penetration by probes larger than \varnothing 2,5 mm</i>	_3	Protetto dalla pioggia <i>Protected against rain</i>
4_	Protetto da penetrazione di sonda con \varnothing superiore a 1 mm <i>Protection against penetration by probes larger than \varnothing 1 mm</i>	_4	Protetto dagli spruzzi di acqua <i>Protected against spraying water</i>
5_	Protetto contro l'ingresso di polvere <i>Protection against ingress of dust</i>	_5	Protetto da getti di acqua <i>Protected against water jets</i>
6_	Stagno alla polvere <i>Dust-tight</i>	_6	Protetto dalle onde <i>Protected against powerful water jets</i>
		_7	Stagno alla sommersione <i>Sealed against immersion</i>
		_8	Stagno alla sommersione <i>Sealed against immersion</i>

CLASSE DI ISOLAMENTO INSULATION CLASS

	Classe 0 Class 0	Apparecchio dotato di solo isolamento funzionale. Protezione: data dall'ambiente. <i>Luminaire with functional insulation only. Protection: given by the environment.</i>
	Classe 1 Class 1	Apparecchio dotato di isolamento di base. Protezione: collegamento delle parti metalliche accessibili alla terra di protezione. <i>Luminaire with basic insulation. Protection: connection of the accessible metal parts to the earthing protection.</i>
	Classe 2 Class 2	Apparecchio dotato di doppio isolamento. Protezione: mediante isolamento supplementare. <i>Luminaire with double insulation. Protection: through additional insulation.</i>
	Classe 3 Class 3	Apparecchio idoneo per alimentazione a bassissima tensione di sicurezza. Protezione: intrinsecamente sicuro. Le parti che portano corrente possono essere accessibili. <i>Luminaire suitable for supply at safety extra low voltage. Protection: intrinsically safe. The live parts can be accessed.</i>

CLASSIFICAZIONE SECONDO IL MATERIALE DELLA SUPERFICIE DI INSTALLAZIONE RATING ACCORDING TO THE MOUNTING SURFACE MATERIAL.

	Apparecchio predisposto per il montaggio diretto su superfici infiammabili. <i>Luminaire designed for direct mounting on inflammable surfaces.</i>
	Apparecchio idoneo ad essere installato su superfici normalmente infiammabili rispettando la distanza indicata tra prodotto e pareti. <i>Luminaire designed for installation on normally inflammable surfaces provided that the distance indicated between product and walls is respected.</i>
	Apparecchio idoneo per montaggio solo su superfici non infiammabili. <i>Luminaire designed for mounting only on non-inflammable surfaces.</i>

APPROVATA QUALITÀ
APPROVED QUALITY



TCNA
TCNA

TCNA, Tile Council of North America, è l'ente Americano che certifica l'AirCoral® come materiale:
ANTIBATTERICO capace di eliminare i batteri dalle superfici;
ANTINQUINANTE capace di ridurre gli elementi inquinanti presenti nell'aria;
FOTOCATALITICO capace di ridurre gli elementi dannosi.

*TCNA, Tile Council of North America, is the American body that has certified the AirCoral® material as:
ANTIBACTERIAL able to eliminate bacteria on its surfaces
ANTI-POLLUTING able to reduce polluting elements in the air
PHOTOCATALYTIC able to reduce harmful elements.*



REACH - sicurezza chimica
REACH - chemical safety

Regolamentazione e certificazione (direttiva Parlamento Europeo) per la produzione di sostanze chimiche, con lo scopo di proteggere l'uomo e l'ambiente da sostanze tossiche.
Il prodotto AirCoral® è privo di sostanze tossiche, non contiene elementi dannosi per la salute dell'uomo o inquinanti secondo l'elenco registrato dall'Agenzia Europea delle sostanze chimiche (ECHA).

*Regulation and certification (European Parliament directive) for the production of chemical substances, in order to protect people and environment against toxic substances.
The AirCoral® product is devoid of toxic substances, it does not contain noxious elements for the human health or polluting elements according to the registered list of the European Agency for chemical substances (ECHA).*



MADE IN ITALY
Iscrizione Buzzi IT
MADE IN ITALY IT
Registration Buzzi

Istituto per la tutela dei produttori italiani. Certifica che la collezione Buzzi & Buzzi è interamente prodotta in Italia, non importata ed utilizza la migliore componentistica elettronica europea. Una garanzia per la lotta alla contraffazione del made in Italy, troppo spesso solo dichiarato senza essere ufficialmente certificato, e per un'assoluta tutela dei consumatori finali. Grazie al certificato "Made in Italy Certificate", si fa netta la distinzione tra la produzione 100% made in Italy e quella semplicemente dichiarata ma di dubbia provenienza.

Institute for the tutelage of the italian manufacturers. It certifies that the Buzzi & Buzzi collection is entirely produced in Italy, not imported and it is using the best european electronic components. A guarantee for the fight against fakes of the made in Italy, too often only declared without being officially certified, and for the absolute tutelage of the final consumers. Thanks to the "Made in Italy Certificate", you can distinguish clearly between the 100% made in Italy production and the one simply declared but with doubtful origin.



Certificazione Europea
European Certification

Conformità Européenne. La Società Buzzi & Buzzi è certificata da Ente Terzo notificato per la sicurezza dei propri prodotti che garantisce la conformità alle più restrittive norme tecniche vigenti.

European Conformity. The company Buzzi & Buzzi is certified by a notified Third Board for the security of the own products, guaranteeing the conformity to the most restrictive technical regulations in force.



Certificazione Gost - R
Certification Gost - R

Certificazione della qualità del prodotto e conformità alle normative ed esigenze della federazione russa.

Product quality certification in conformity to the regulations and requirements of the Russian Federation.



Certificazione LEED
LEED Certification

La certificazione LEED, Leadership in Energy and Environmental Design, è lo standard riconosciuto per misurare l'impatto ambientale e la sostenibilità degli edifici. Ottenere la certificazione LEED è il miglior modo per dimostrare che un edificio, in ogni sua parte, è veramente "green".

LEED (Leadership in Energy and Environmental Design) certification is the recognised standard for measuring the environmental impact and sustainability of buildings. LEED certification is the best proof that a building is well and truly "green".



Certificazione UL
UL Certification

UL, Underwriters Laboratories, è il laboratorio di prova maggiormente riconosciuto per l'omologazione degli apparecchi commercializzati in America.

La collezione Buzzi & Buzzi è in fase di certificazione; contattare l'azienda per ulteriori informazioni.

UL, Underwriters Laboratories, is the best recognised test lab for the certification of devices traded in America. Buzzi & Buzzi's collection is currently in the process of being certified. Please contact the company for further information.



Certificazione ETL
ETL Certification

ETL, Electrical Testing Laboratories, è una certificazione di sicurezza. Indica che il prodotto è stato testato per poter essere venduto e distribuito nel territorio nordamericano. La collezione Buzzi & Buzzi è certificata; si prega di contattare per ulteriori aggiornamenti.

ETL, Electrical Testing Laboratories, is a quality certification. It guarantees that the product was tested before being sold and delivered within the North American boundaries. The collection of Buzzi & Buzzi is certified; for further updates, please contact us.

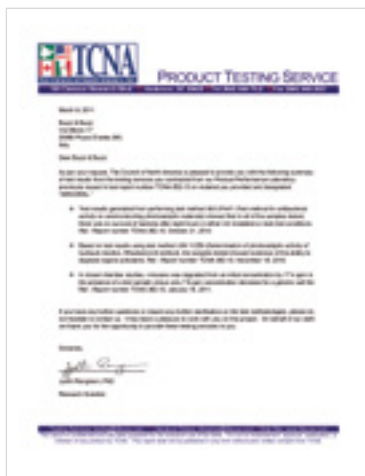

Ogni prodotto in AirCoral® viene corredato del certificato "PRODUCT TESTING SERVICE" fornito dal Tile Council of North America.
Ogni prodotto in AirCoral® è identificato da apposita marchiatura con targa in alluminio.

Every product made with AirCoral® is accompanied by a "PRODUCT TESTING SERVICE" certificate provided by the Tile Council of North America. Every product made with AirCoral® is identified by a marking with a special aluminum plate.



Testato per impermeabilità con pressione a (200 +/- 50) kPa pari a 2 atm per (72 +/- 2) h, secondo la normativa (UNI EN 12390-8:2009).
Tested by: Istituto Giordano

Tested for water resistance under pressure conditions of (200 +/- 50) kPa equal to 2 atm per (72 +/- 2) h, according to the (UNI EN 12390-8:2009) regulation.
Tested by: Istituto Giordano

What about Coral®

	C	A/C	C/W	D/C
NO EXPANSION	●	●	●	●
THERMAL RESISTANCE	●	●	●	●
NOT FLAMMABLE	●	●	●	●
LOWEST THERMIC CONDUCTIBILITY	●	●	●	●
RESISTANCE TO TEMPERATURE SHOCKS	●	●	●	●
HARDNESS	●	●	●	●
UV RESISTANT	●	●	●	●
PAINTABLE	●	●	●	●
DUST REPULSIVE	●	●	●	●
WHITE SATIN SURFACE	●	●	●	●
NOT TOXIC	●	●	●	●
NO CHEMICAL REACTIVITY	●	●	●	●
ANTI-ALLERGIC	●	●	●	●
WATERPROOF	●	●	●	●
ANTIBACTERIAL	●	●	●	●
DEGRADATION OF POLLUTANTS	●	●	●	●
PHOTOCATALYTIC	●	●	●	●
VANDAL RESISTANT	●	●	●	●
MECHANICAL RESISTANCE	●	●	●	●
SCRATCH RESISTANT	●	●	●	●
ABRASION RESISTANCE	●	●	●	●
SALT RESISTANCE	●	●	●	●
CHLORINE RESISTANCE	●	●	●	●
FROST RESISTANCE	●	●	●	●
WEATHER RESISTANCE	●	●	●	●
EXTRA THIN HI-TECH SURFACE	●	●	●	●

SVANTAGGI DEI MATERIALI CONCORRENTI COMPETITORS DISADVANTAGES

Metallo <i>Metal</i>	dilatazione termica, conducibilità termica, verniciature sensibili ai raggi UV e reagenti chimici, no prodotto custom.	<i>thermal expansion, thermal conductivity, paintings sensible to UV rays and chemical reagents, no custom product.</i>
Plastica <i>Plastic</i>	no resistenza termica, sviluppa fumi tossici, verniciature sensibili ai raggi UV e reagenti chimici, no prodotto custom.	<i>no thermal resistance, it develops toxic fumes, paintings sensible to UV rays and chemical reagents, no custom product.</i>
Vetro <i>Glass</i>	fragilità meccanica, conducibilità termica, impossibili forme complesse, no prodotto custom.	<i>mechanical fragility, thermal conductivity, impossibility of complex shapes, no custom product.</i>
Gesso <i>Plaster</i>	no resistenza termica, fragilità meccanica, impossibili forme complesse, si disidrata con il tempo.	<i>no thermal resistance, mechanical fragility, impossibility of complex shapes, it gets dehydrated within time.</i>



RESISTENTE ALLE TEMPERATURE ELEVATE E AGLI SHOCK TERMICI
HIGH TEMPERATURE AND THERMAL SHOCK RESISTANT

Resistenza termica <i>Thermal resistance</i>	maggiore 250° C <i>higher than 250° C</i>	resistenza al fuoco, agli sbalzi termici e al calore <i>resistant to fire, thermal shocks and heat</i>
Temperatura di fusione <i>Melting temperature</i>	maggiore 1400° C <i>higher than 1400° C</i>	punto fusione elevatissimo <i>very high melting point</i>
Punto infiammabilità <i>Flammable point</i>	nessuno <i>none</i>	non infiammabile; totale sicurezza passiva; assenza fumi in caso di incendi <i>not flammable; total passive security; smoke absence in case of fire</i>

ALTO GRADO DI RESISTENZA AI GRAFFI E AGLI URTI
HIGH RESISTANCE DEGREE FOR SCRATCHES AND CRASHES

DUREZZA <i>HARDNESS</i>	superiore 300 N/mm ² <i>higher than 300 N/mm²</i>	elevata durezza all'incisione <i>high cut hardness</i>
RESISTENZA ALLA COMPRESSIONE <i>COMPRESSION RESISTANCE</i>	55 N/mm ² <i>55 N/mm²</i>	il prodotto ha un elevato grado di compressione <i>the product has a high compression degree</i>

ELEVATA RIFLESSIONE LUMINOSA EXTRA WHITE
EXTRA WHITE HIGH LUMINOUS REFLECTION

Luminanza <i>Luminance</i>	riflessione maggiore 97% <i>reflection higher than 97%</i>	elevata riflessione luminosa mantiene lo spettro cromatico della radiazione riflessa <i>high luminous reflection it keeps the chromatic spectrum of the reflected radiation</i>
Colore <i>Colour</i>	AirCoral® naturale <i>natural AirCoral®</i>	extra white; bianco setoso naturale <i>extra white; natural silky white</i>
Superficie <i>Surface</i>	effetto satinato bianco <i>white satin effect</i>	confortevole al tatto; sensazione tattile calda; effetto vellutato <i>touch comfortable; warm touch sensation; velvet effect</i>
Decorazione <i>Decoration</i>	decorabile <i>decorable</i>	decorabile con qualsiasi pittura all'acqua o acrilica <i>decorable with each kind of water or acrylic paint</i>
Manutenzione <i>Maintenance</i>	assente <i>absent</i>	non necessita di manutenzione in caso di sporcizia pulire con carta leggermente abrasiva grano P320 <i>no maintenance necessary in case of dirty to clean with light abrasive paper grain P320</i>

NON TOSSICO, ANALLERGICO
NOT TOXIC, ANTI-ALLERGIC

Tossicità <i>Toxicity</i>	assente (= 0) <i>absent (= 0)</i>	prodotto anallergico; non tossico <i>anti-allergic product; not toxic</i>
Reazione pericolosa <i>Dangerous reaction</i>	nessuna (= 0) <i>no reaction (= 0)</i>	prodotto adatto a qualsiasi tipo di ambiente; nessuna reazione irritante <i>product suitable for each kind of surroundings; no irritating reaction</i>
Comportamento <i>Behaviour</i>	materiale igroscopico <i>hygroscopic material</i>	adatto anche ad ambienti umidi compatibilmente al cablaggio adottato <i>suitable also for wet surroundings compatible with the applied wiring</i>

DC DURCORAL®

SPECIFICHE
SPECIFICATIONS

Colore (decorabile) <i>Color (paintable)</i>	standard DurCoral® Bianco ghiaccio <i>standard color DurCoral® Ice white</i>	Resistenza meccanica alla compressione <i>Compressive strength</i>	≥140 N/mm ² ≥ 140 N/mm ²
Resistenza all'umidità <i>Humidity resistance</i>	elevatissima <i>very high</i>	Resistenza meccanica alla flessione <i>Flexural strength</i>	≥ 55 N/mm ² ≥ 55 N/mm ²
Porosità all'acqua <i>Porosity to water</i>	≤ 2% ≤ 2%	Spolverabilità di superficie <i>Surface sprinkling ability</i>	≤ 7 gr/mq ≤ 7 gr/mq
Resistenza al gelo /disgelo severo <i>Resistance to severe freezing / thawing</i>	elevatissima <i>very high</i>		



ALKABOX	176	ANGOLO	356	LINEA 5	322
BARD	400	ARGIA	230	MARKUS	256
BASIC ROUND	162	ATOM	142	MASTER OPEN	304
BASIC SQUARE	166	BAUTA ELLISSE	334	MAXIMAL	328
BILD	204	BAUTA SFERA	344	MINI SECRET	138
BULL	108	BELL	116	MINIMAL	330
ELLISSE BASE	342	BITRIX	154	MODUS	326
GENIUS BASIC	70	BLACK BOX	170	MOTUS	290
GENIUS BASIC FLAT	74	BLADE	236	NASTRO	286
GENIUS BASIC SLOPE	76	BUZZZ	120	NEFI	178
LYS	214	CLASS	136	NIMBUS	182
MAXI BILD	208	CORNICE	374	NOVA	218
MAXI RIM	212	CUPOLA	354	PIPEDINO DIRECT	302
NOTHING	266	DOT	380	PIPEDINO INDIRECT	298
PHANTOM	242	DRY	132	PIPEDINO OPEN	310
RHINO	98	ECLA	196	PIPEDO	296
RIM	210	EGGY	126	PIPEDO DIRECT	300
SFERA BASE	352	ELIOS	200	PIPEDO OPEN	306
TAURUS	102	ELLISSE	336	PIXEL	92
TELESCOPIC	404	END	274	PIXEL C	376
		FLAG	360	POLARIS	226
		FLEXI	292	PONTE GRANDE	366
		FOCUS	190	PONTE PICCOLO	368
		FRAME	362	RING	158
		FUNNEL LAMP	412	SFERA	346
		GAP	270	SFERA S 300	350
		GENIUS	30	SIDUS	396
		GENIUS BLACK	64	SKY	386
		GENIUS BRASS	58	SLICE	112
		GENIUS CURVE	66	SLICE C	392
		GENIUS DIM TO WARM	54	SPIRIT	248
		GENIUS DYNAMIC WHITE	50	STAR	390
		GENIUSQUARE	42	SUPERNOVA	222
		GENIUSQUARE BRASS	62	TEKNO	186
		GHOST	244	TETRIS	156
		GLOBE	252	TORCE	358
		INVIDIA	260	TWIN GENIUS	36
		INVISIBLE	134	TWIN GENIUSQUARE	46
		INVISILED	144	UNLEAF	278
		INZETA	94	VERSUS	332
		ITEM ONE	416	WHITE BOX	172
		JACOBBOX	150	YANG	314
		LEAF	282	YIN	318
		LENTIL	234	ZEN	408
		LIGHT	148	ZOOM	192
		LIGHT BOX	370		



DC DURCORAL®

IRON

ALADIN IP65	456	MINIVIRTUS DIRECT IP65	470	GENIUS BASIC NAKED	86
BLADE IP44/IP65	450	MINIVIRTUS IP65	464	GENIUS BASIC NAKED IP65	430
GENIUS BASIC IP65	426	MOND IP65	494	GENIUS CONCRETE	88
GENIUS IP65	422	NUSS IP65	462	GENIUS NAKED	78
HOLE	418	PASSÉ IP65	458	GENIUS NAKED IP65	428
IDROROUND IP65	440	THE BOLLARD	490	TWIN GENIUS NAKED	84
IDROUT IP65	436	THE NUDE	474		
INVISILED IP44/IP65	432	UNDERLINE	478		
ORIS IP65	444	UNDERScore	482		
PHANTOM IP44/IP65	448	VALO IP65	486		
		VIRTUS DIRECT IP65	472		
		VIRTUS IP65	468		

A

ALADIN IP65	456
ALKABOX	176
ANGOLO	356
ARGIA	230
ATOM	142

B

BARD	400
BASIC ROUND	162
BASIC SQUARE	166
BAUTA ELLISSE	334
BAUTA SFERA	344
BELL	116
BILD	204
BITRIX	154
BLACK BOX	170
BLADE	236
BLADE IP44/IP65	450
BULL	108
BUZZZ	120

C

CLASS	136
CORNICE	374
CUPOLA	354

D

DOT	380
DRY	132

E

ECLA	196
EGGY	126
ELIOS	200
ELLISSE	336
ELLISSE BASE	342
END	274

F

FLAG	360
FLEXI	292
FOCUS	190
FRAME	362
FUNNEL LAMP	412

G

GAP	270
GENIUS	30
GENIUS BASIC	70
GENIUS BASIC FLAT	74
GENIUS BASIC IP65	426
GENIUS BASIC NAKED	86
GENIUS BASIC NAKED IP65	430
GENIUS BASIC SLOPE	76
GENIUS BLACK	64
GENIUS BRASS	58
GENIUS CONCRETE	88
GENIUS CURVE	66
GENIUS DIM TO WARM	54
GENIUS DYNAMIC WHITE	50
GENIUS IP65	422
GENIUS NAKED	78
GENIUS NAKED IP65	428
GENIUSQUARE	42
GENIUSQUARE BRASS	62
GHOST	244
GLOBE	252

H

HOLE	418
------	-----

I

IDROROUND IP65	440
IDROUT IP65	436
INVIDIA	260
INVISIBLE	134
INVISILED	144
INVISILED IP44/IP65	432
INZETA	94
ITEM ONE	416

J

JACOBOX	150
---------	-----

L

LEAF	282
LENTIL	234
LIGHT	148
LIGHT BOX	370
LINEA 5	322
LYS	214

M

MARKUS	256
MASTER OPEN	304
MAXI BILD	208
MAXI RIM	212
MAXIMAL	328
MINI SECRET	138
MINIMAL	330
MINIVIRTUS DIRECT IP65	470
MINIVIRTUS IP65	464
MODUS	326
MOND IP65	494
MOTUS	290

N

NASTRO	286
NEFI	178
NIMBUS	182
NOTHING	266
NOVA	218
NUSS IP65	462

O

ORIS IP65	444
-----------	-----

P

PASSÈ IP65	458
PHANTOM	242
PHANTOM IP44/IP65	448

PIPEDINO DIRECT	302
PIPEDINO INDIRECT	298
PIPEDINO OPEN	310
PIPEDO	296
PIPEDO DIRECT	300
PIPEDO OPEN	306
PIXEL	92
PIXEL C	376
POLARIS	226
PONTE GRANDE	366
PONTE PICCOLO	368

R

RHINO	98
RIM	210
RING	158

S

SFERA	346
SFERA BASE	352
SFERA S 300	350
SIDUS	396
SKY	386
SLICE	112
SLICE C	392
SPIRIT	248
STAR	390
SUPERNOVA	222

T

TAURUS	102
TEKNO	186
TELESCOPIC	404
TETRIS	156
THE BOLLARD	490
THE NUDE	474
TORCE	358
TWIN GENIUS	36
TWIN GENIUS NAKED	84
TWIN GENIUSQUARE	46

U

UNDERLINE	478
UNDERScore	482
UNLEAF	278

V

VALO IP65	486
VERSUS	332
VIRTUS DIRECT IP65	472
VIRTUS IP65	468

W

WHITE BOX	172
-----------	-----

Y

YANG	314
YIN	318

Z

ZEN	408
ZOOM	192

Index by Code

0

00010KIT
0008KIT
0009KIT

171
121
151

1

1004.00
1005.00
1006.00
1007.AC
1008.AC
1051.1.AC
1052.AC
1058.AC
1061
1062
1065
1066
1071
1072
1075
1076
1407.AC
1408.AC
1409.AC
1451.AC
1452.AC
1508.DC
1604.CW
1624.DC
1728.DC
1729.DC
1731.DC
1741.DC
1751.DC
1811.00
1812.00
1813.00
1831.00
1832.00
1833.00
1834.00
1835.00
1836.00

403
401
401
93
377
361
361
361
80
80
85
85
87
87
90
90
413
413
413
409
409
459
419
487
495
475
491
480
483
109
109
111
103
103
105
103
103
105

1841.00
1842.CW
1843.00
1846.AC
1847.AC
1848.AC
1849.AC
1851.AC
1852.AC
1853.AC
1854.AC
1855.AC
1856.AC
1857.AC
1858.AC
1861.AC
1862.AC
1865.00
1866.00
1871.AC
1872.AC
1875.AC
1881.AC
1885.00
1886.00
1887.00
1888.00
1891.AC
1892.AC
1895.AC
1896.AC
1901.AC
1902.AC
1911.AC
1913.AC
1915.AC
1921.AC
1922.AC
1951.CW
1952.CW
1985.CW
1986.CW

99
457
99
95
95
95
95
31
37
43
47
31
43
37
47
59
59
77
77
65
65
56
51
71
71
75
75
67
67
63
63
117
117
381
381
381
114
393
423
423
427
427

2

2021.AC

359

2071
2072
2075
2076
2106.AC
2107.AC
2191.AC
2192.AC
2206.AC
2207.AC
2306.AC
2307.AC
2403.AC
2503.AC
2713.AC
2718.AC
2802.AC
2804.AC
2804.ARTUSI
2804.BENVENUTO
2804.FORLINI
2804.GIAGNACOVO
2804.JUNG
2804.LONGONI
2804.MARINONI
2804.MESKINI
2805.P.AC
2808.AC
2816.AC
2826.AC
2900
2901.AC
2902.AC
2904.EB.AC
2906.AC
2907.P.AC
2908.AC
2910
2911.AC
2912.AC
2914.EB.AC
2915.P.AC
2916.AC
2920
2921.AC
2922.AC

431
431
429
429
371
371
333
333
371
371
373
373
373
373
329
329
363
363
364
365
365
365
365
364
364
364
365
364
363
363
319
315
297
297
297
297
297
307
307
307
307
307
299
311
311

2924.EB.AC
2926.AC
2927.AC
2928.AC
2932.AC
2936.AC
2937.AC
2938.AC
2944.AC
2946.AC
2950
2953.AC
2954.AC
2955.P.AC
2956.AC
2958.AC
2964.EB.AC
2965.AC
2968.AC
2974.AC
2975.P.AC
2979.AC
2988.AC
2998.AC

3

3022.AC
3028.Z.AC
3032.AC
3042.AC
3044.DC
3046.DC
3048.Z.AC
3054.54.DC
3058.58.DC
3061.DC
3062.DC
3064.64.DC
3068.68.DC
3074.DC
3078.DC
3111.00
3112.00
3113.Z.00
3121.00

311
311
303
303
331
299
299
331
327
327
305
305
305
305
305
301
301
301
287
287
287
283
279
397
397
391
387
465
465
387
469
469
463
463
473
473
471
471
167
167
167
163

3122.00	163	6003.00	405	6185.AC	193	6343.Z.AC	155
3123.Z.00	163	6004.00	405	6191.AC	137	6347.CW	433
4		6006.00	405	6192.AC	137	6348.AC	145
4411.00	209	6007.00	406	6193.Z.AC	137	6349.CW	433
4416.00	209	6010.00	406	6199.Z.AC	137	6358.AC	235
4417.00	209	6011.00	406	6211.00	177	6361.AC	291
4421.00	215	6025.AC	188	6212.AC	417	6366.AC	291
4422.00	205	6027.AC	188	6213.Z.AC	197	6368.AC	291
4423.Z.00	205	6029.P.AC	188	6218.Z.AC	179	6371.AC	201
4424.00	205	6034.AC	187	6219.Z.AC	179	6376.AC	201
4425.00	215	6036.AC	187	6221.00	177	6381.AC	201
4426.Z.00	215	6038.P.AC	187	6231.00	177	6383.AC	201
4432.00	211	6051.AC	187	6238.Z.AC	159	6385.AC	201
4433.Z.00	211	6052.AC	187	6239.Z.AC	159	6461.AC	291
4434.00	211	6061.AC	171	6241.AC	151	6463.AC	291
4441.00	213	6066.AC	173	6242.AC	157	6471.AC	293
4446.00	213	6071.AC	171	6243.AC	159	6478.AC	293
4447.00	213	6076.AC	173	6244.AC	151	6479.P.AC	293
		6081.AC	171	6246.Z.AC	157	6487.CW	449
		6086.AC	173	6248.Z.AC	151	6488.00	243
		6111.AC	133	6249.Z.AC	151	6489.CW	449
5		6112.AC	133	6252.AC	249	6498.AC	127
5133.AC	223	6113.Z.AC	133	6253.AC	159	6600	261
5134.AC	223	6121.AC	133	6258.AC	249	6601	261
5135.AC	223	6122.AC	133	6259.AC	249	6631.AC	261
5271.AC	219	6131.AC	135	6261.AC	179	6639	262
5276.AC	219	6132.AC	135	6262.AC	179	6640.AC	261
5285.AC	219	6133.Z.AC	135	6263.AC	197	6650.AC	261
5291.AC	219	6139.Z.AC	135	6264.EB.AC	249	6900.AC	259
5293.AC	219	6141.AC	139	6265.AC	197	6910.AC	259
5371.CW	445	6142.AC	139	6268.Z.AC	197	6921.AC	231
5376.CW	445	6143.Z.AC	139	6271.AC	183	6931.AC	231
5381.CW	445	6149.Z.AC	139	6276.AC	183	6953.AC	257
5385.CW	445	6152.AC	143	6281.AC	183	6954.EB.AC	257
5388.CW	445	6153.Z.AC	143	6283.AC	183	6961.AC	238
5481.CW	437	6155.AC	121	6285.AC	183	6962.AC	238
5483.Z.CW	437	6157.Z.AC	121	6289.AC	253	6963.CW	452
5489.Z.CW	437	6158.Z.AC	121	6292.AC	253	6964.CW	452
5591.CW	441	6161.AC	191	6294.EB.AC	253	6965.CW	451
5593.Z.CW	441	6162.AC	191	6298.AC	253	6966.CW	451
5599.Z.CW	441	6163.Z.AC	191	6313.AC	149	6967.AC	237
		6169.Z.AC	191	6318.Z.AC	149	6968.AC	237
		6171.AC	193	6323.AC	149	6974.AC	227
		6176.AC	193	6328.Z.AC	149	6975.P.AC	227
6		6181.AC	193	6333.AC	245	6977.AC	227
6001.00	405	6183.AC	193	6342.AC	155	6978.AC	227

Index by Code

6987.CW	451	7488.AC	335	9017	269	BR3123LT	163
6988.CW	451	7621.AC	357	9017.21	269	BR4416LT	209
		7622.AC	357	9018	269	BR4421LT	215
7		7721.AC	357	9020.AC	324	BR4422LT	205
7001.AC	349	7722.AC	357	9024.AC	323	BR4423LT	205
7003.AC	349	7821.AC	357	9026.AC	323	BR4424LT	205
7011.AC	348	7822.AC	357	9030	324	BR4425LT	215
7013.AC	348	7900	367	9031	323	BR4426LT	215
7015.AC	348	7901.AC	367	9100.AC	324	BR4432LT	211
7018.AC	348	7902.AC	367			BR4433LT	211
7021.AC	347	7905.AC	367	B		BR4434LT	211
7023.23.AC	347	7908.AC	367			BR4446LT	213
7024.EB.AC	347	7920	369	BR1007LT	93	BR5376LT	445
7028.AC	347	7921.AC	369	BR1851LT	31	BR5388LT	445
7042.00	353	7922.AC	369	BR1852LT	37	BR5481LT	437
7080	345	7934.AC	355	BR1853LT	43	BR5483LT	437
7081.AC	345	7938.AC	355	BR1854LT	47	BR5591LT	441
7083.83.AC	345			BR1855LT	31	BR5593LT	441
7084.EB.AC	345	8		BR1856LT	43	BR6025LT	188
7088.AC	345	8101	273	BR1857LT	37	BR6027LT	188
7121.AC	351	8102	273	BR1858LT	47	BR6029PLT	188
7122.AC	351	8108	273	BR1861LT	59	BR6034LT	187
7124.EB.AC	351	8200.AC	275	BR1862LT	59	BR6036LT	187
7135.AC	348	8210	275	BR1865LT	77	BR6038PLT	187
7140	349	8214	275	BR1866LT	77	BR6051LT	187
7145.AC	349	8215	275	BR1871LT	65	BR6052LT	187
7148.AC	349	8219	275	BR1872LT	65	BR6161LT	191
7403.3.AC	339	8300.AC	271	BR1875LT	56	BR6162LT	191
7405.5.AC	339	8310.AC	271	BR1881LT	51	BR6163LT	191
7411.AC	338	8320	271	BR1885LT	71	BR6218LT	179
7413.AC	338	8330.AC	271	BR1886LT	71	BR6238LT	159
7415.5.EB.AC	338	8340.AC	271	BR1887LT	75	BR6241LT	151
7421.AC	337	8350.AC	271	BR1888LT	75	BR6243LT	159
7423.23.AC	337			BR1891LT	67	BR6244LT	151
7424.EB.AC	337	9		BR1892LT	67	BR6248LT	151
7428.AC	337	9000.AC	375	BR1895LT	63	BR6252LT	249
7435.AC	339	9005.AC	375	BR1896LT	63	BR6253LT	159
7438.AC	339	9010.00	267	BR1951LT	423	BR6258LT	249
7442.00	343	9011.08	267	BR1952LT	423	BR6259LT	249
7445.AC	338	9011.16	267	BR1985LT	427	BR6261LT	179
7448.AC	338	9011.24	267	BR1986LT	427	BR6262LT	179
7480	335	9011.32	267	BR3111LT	167	BR6263LT	197
7481.AC	335	9013.00	267	BR3112LT	167	BR6264EBLT	249
7483.83.AC	335	9014.00	267	BR3113LT	167	BR6265LT	197
7484.EB.AC	335			BR3121LT	163	BR6268LT	197
				BR3122LT	163	BR6276LT	183

BR6283LT	183
BR6313LT	149
BR6318LT	149
BR6323LT	149
BR6328LT	149
BR6333LT	245
BR6358LT	235
BR6376LT	201
BR6383LT	201
BR6487LT	449
BR6488LT	243
BR6489LT	449
BR6498LT	127
BR6965LT	452
BR6966LT	452
BR6967LT	238
BR6968LT	238
BR6987LT	452
BR6988LT	452

H

H3535	175
H3536	175
H3537	175
H8024.25	269
H8024.D	480
H8060.LED	121
H8067IP	459
H8105	149
H8150	157
H8300.A	114
H8350	145
H8350DA.AM	56
H8350PH.AM	56
H8500.B	117
H8500.C	99
H8500.E	90
H8700.E	31
H8700DA	51
H8730	109



Catalogo Generale
 In questo catalogo è presente tutta la gamma degli apparecchi prodotta da Buzzi & Buzzi. Uno strumento perfetto per gli studi di architettura.

General Catalogue
 In this catalogue is enclosed the whole range of fittings produced by Buzzi & Buzzi. A perfect instrument for architectural studies.

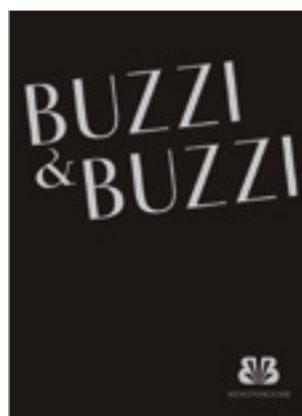

Catalogo Memo
 In questo catalogo sono rappresentati tutti i prodotti Buzzi & Buzzi. Lo strumento più adatto per il cliente finale.

Memorandum Catalogue
 In this catalogue all Buzzi & Buzzi products are present. This is the ideal instrument for the final client.

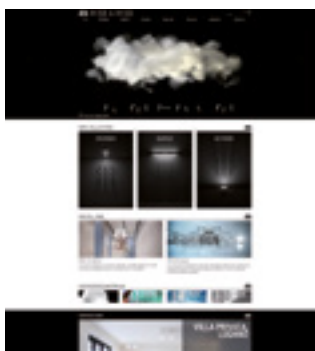

www.buzzi-buzzi.it
 Buzzi & Buzzi è attiva nei social Facebook, Twitter, Pinterest, LinkedIn. Il canale ideale per colloquiare velocemente con clienti, progettisti ed architetti.

www.buzzi-buzzi.it
 Buzzi & Buzzi is present on Facebook, Twitter, Pinterest, LinkedIn. The ideal way to interact quickly with clients, planners and architects.



Sample box
 Scatola contenente i 4 materiali Coral® - AirCoral® - DurCoral® - Coral WaterOut® della collezione Buzzi & Buzzi. Per chi cerca una verifica materiale del livello qualitativo Buzzi & Buzzi.

Sample box
 This box contains the 4 materials used in Buzzi & Buzzi production: Coral® - AirCoral® - DurCoral® - Coral WaterOut®. For those who want a concrete confirmation of Buzzi & Buzzi quality standard.



Chiavetta USB
 La chiavetta USB Buzzi & Buzzi è utile per archiviare tutti i file e trasferirli in modo comodo.

Pen Drive
 Buzzi & Buzzi's pen drive is useful to archive and transfer all your files in an easy way.



T-shirt
 La t-shirt Buzzi & Buzzi prodotta in serie limitata.

T-shirt
 The Buzzi & Buzzi's t-shirt produced in a limited edition.



Supergaranzia

Buzzi & Buzzi permette di estendere gratuitamente ai propri clienti la garanzia dei prodotti acquistati fino ad un massimo di 3 anni.

Super Warranty

Buzzi & Buzzi gives to its customers the possibility to extend the guarantee on its products until a maximum of 3 years.



Certificato TCNA

Ogni prodotto in AirCoral® è corredato di certificato rilasciato dal TCNA, attestante le caratteristiche fotocatalitiche e antibatteriche dei prodotti in AirCoral®.

TCNA Certification

Each AirCoral® product is furnished with TCNA Certification, that grants the photocatalytic and antibacterial properties of AirCoral®.



Targa INOX serigrafata

Ogni prodotto in AirCoral® è corredato di targa incisa con i riferimenti del brevetto AirCoral®.

Silkscreened steel plate

Each AirCoral® product is furnished with an impressed plate with the reference of AirCoral® patent.

OX: expositive system

Il sistema OX permette di costruire un'area espositiva flessibile e dall'elevato effetto architettonico.
 Può diventare BANCO RECESSION, LIBRERIA, SEDUTA (corredata di cuscino), includendo le bellezze della collezione Buzzi & Buzzi.
 I nostri uffici sono a vostra disposizione per definire l'offerta migliore in base alle singole esigenze.

*OX expositive system permits to create a flexible expositive area, with a great architectural impact.
 It can be RECEPTION, BOOKSHELVES, SITTING (with a pillow), that shows Buzzi & Buzzi products.
 Our offices are at your complete disposal to help you in defining the best solution for your specific necessities.*



OX-1

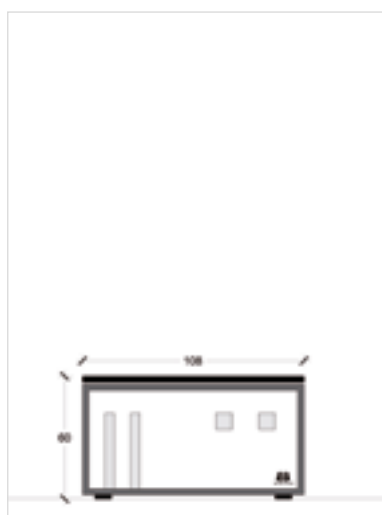

OX-2

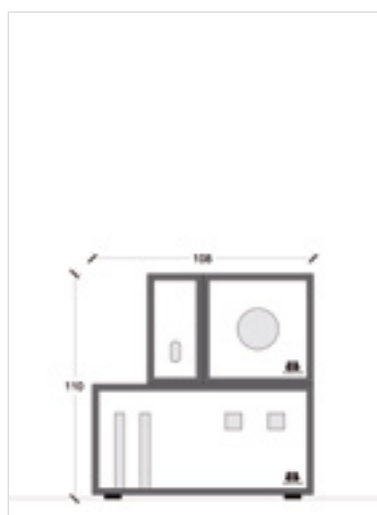

OX-3

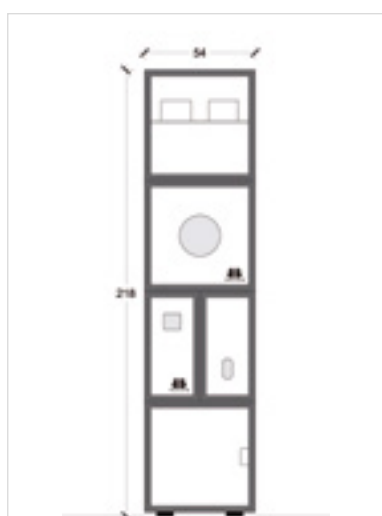

OX-4

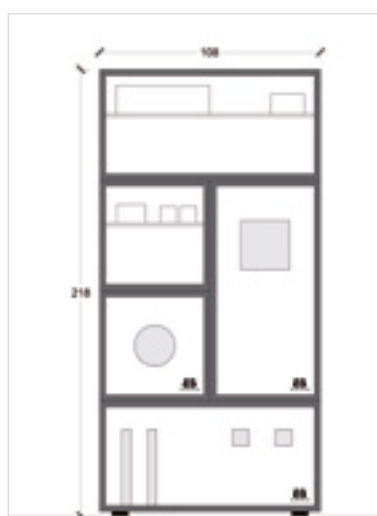

OX-5



Buzzi & Buzzi si riserva la facoltà di variare o modificare, senza preavviso, le dimensioni e le caratteristiche tecniche dei prodotti indicati in questo catalogo in funzione delle necessità operative, per migliorarne la funzionalità o in adeguamento a normativa di legge.

Buzzi & Buzzi reserves itself the faculty to change or to modify, without advance notice, the dimensions and the technical characteristics of the products indicated in this catalogue, due to operative necessities to improve the functionality or updating with law regulation.





Legal Office
20060 Pozzo d'Adda (MI) via Milano 17, Italy

Headquarter
24040 Canonica d'Adda (BG) via Pascoli 5, Italy

Tel. +39 02 9094942 - +39 02 9094944
Fax +39 02 9094006

buzzi@buzzi-buzzi.it
www.buzzi-buzzi.it

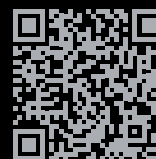

Download the catalogue