

FLEXALIGHTING

smart
book
2023

FLEXALIGHTING

- ▶ visual index
- ▶ alphabetical index
- ▶ about us
- ▶ contacts





FLUSH OPTIC DOWNLIGHTS



RECESSED OPTIC DOWNLIGHTS



TRIMLESS DOWNLIGHTS



ADJUSTABLE DOWNLIGHTS



STEPLIGHTS



TRIMLESS PROJECTORS



SEMI-RECESSED PROJECTORS



SURFACE PROJECTORS



TRIMLESS PENDANTS



SEMI-RECESSED PENDANTS



PENDANTS



LINEAR SYSTEMS



CEILING & WALL MOUNTED



IP RATED DOWNLIGHTS



UPLIGHTS & PATHLIGHTS



IP RATED PROJECTORS



BOLLARDS



RGB

FLUSH OPTIC DOWNLIGHTS



SKY
0,75W IP44



SELENE
1-2W IP65

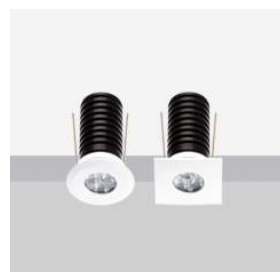

KOL
3-6W IP65

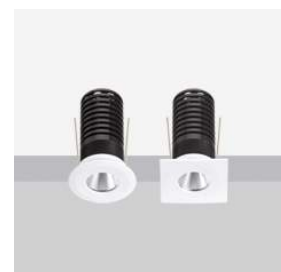

KOL EVO
6W IP44



BELEM
7-14W IP65



FLEXUS 6
6W IP44

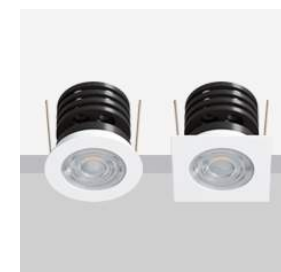

FLEXUS 10
10W IP44

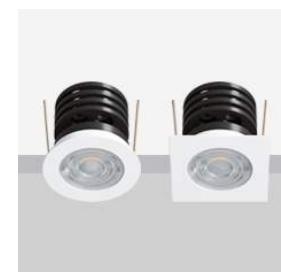

FLEXUS 724
7W IP44



LEAF 6
6W IP44



LEAF 10
10W IP44



WOLF
2W IP44



TAG
7W IP44

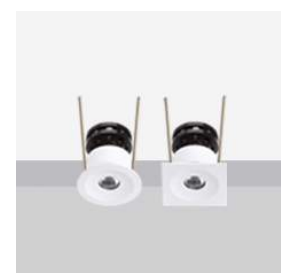

HERO 2
1-2W IP44

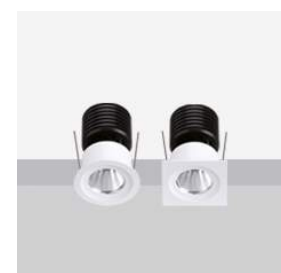

HERO 6
6W IP44



HERO 10
10W IP44



HERO 20
20W IP44



JUNO 10
10W IP20



JUNO 20
20W IP20



LOREN 10
10W IP20



LOREN 20
20W IP20



KURT R10
10W IP44



KURT Q10
10W IP44



NAP 10
10W IP44



NAP 20
20W IP44

RECESSED OPTIC DOWNLIGHTS

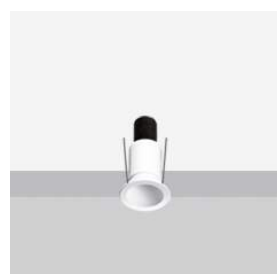

BYE
0,75W IP44



BABA R2
1-2W IP44



BABA Q2
1-2W IP44

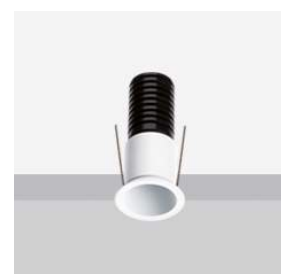

BABA R6
3-6W IP44

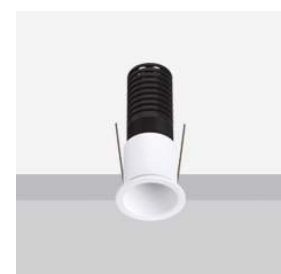

BABA R6 EVO
6W IP44



BABA Q6
3-6W IP44

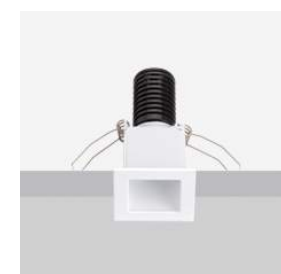

BABA Q6 EVO
6W IP44



BABA R10
10W IP44



BABA R14
7-14W IP44



FRANNY 6
6W IP44



FRANNY 10
10W IP44



FRANNY 724
7W IP44

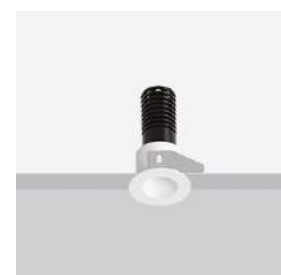

LEAF 6 UGR
6W IP44



LEAF 10 UGR
10W IP44



MACAIA
2W IP44



NEIL
7W IP44



CORE 2
1-2W IP44



CORE 6
6W IP44



CORE 10
10W IP44



CORE 20
20W IP44

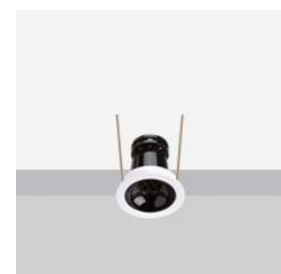

BLACK 2
1-2W IP44



BLACK 6
6W IP44



BLACK 10
10W IP44



HAP 110
10W IP40



HAP 120
2x10W IP40



HAP 130
3x10W IP40



HAP 140
4x10W IP40



JIMBO 2
1-2W IP40



JIMBO 10
10W IP40

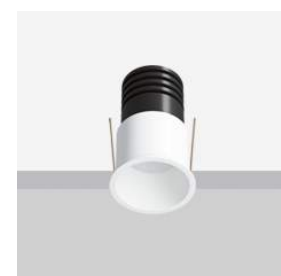

ZED
1-2W IP44



TASK 2
1-2W IP44



TASK 10
10W IP44

TRIMLESS DOWNLIGHTS



ZERINO
0,75W IP44



ZERO R2
1-2W IP44



ZERO Q2
1-2W IP44



ZERO R6
3-6W IP44



ZERO R6 EVO
6W IP44



ZERO Q6
3-6W IP44



ZERO Q6 EVO
6W IP44



ZERO R10
10W IP44



ZERO R14
7-14W IP44



ZERO Q14
7-14W IP44



ZERO MOVE 2
1-2W IP44



ZERO MOVE 6
3-6W IP44



ZERO MOVE 6 EVO
6W IP44



DIDDI
1-2W IP44



NONE R2
1-2W IP44



NONE R10
10W IP44



NONE Q10
10W IP44



CHARLES
2W IP44



HOLE
7W IP44



ZOE 6
6W IP44



ZOE 10
10W IP44



ZOE 724
7W IP44



MOON R2
1-2W IP44



MOON R6
6W IP44

TRIMLESS DOWNLIGHTS



MOON R10
10W IP44

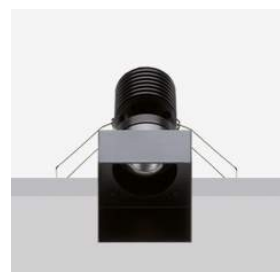

MOON Q10
10W IP44



MOON QX120
2x10W IP44



MOON QX130
3x10W IP44



MOON R20
20W IP44



MOON Q20
20W IP44



SEXUS 6
6W IP44



SEXUS 10
10W IP44



SEXUS 724
7W IP44



SEXUS 6 UGR
6W IP44



SEXUS 10 UGR
10W IP44



SEXUS 724 UGR
7W IP44



TIO TRIMLESS
7W IP40



RAÛL 10 TRIMLESS
10W IP40



MILO 10
10W IP20



MILO X120
2x10W IP20



MILO X130
3x10 W IP20

ADJUSTABLE DOWNLIGHTS



ANDREW
0,75W IP44



DAHLIA
1-2W IP65



ADAN
3-6W IP65



ADAN EVO
6W IP44



JOEL 2
1-2W IP65



JOEL 6
3-6W IP65



JOEL 6 EVO
6W IP44



PLEXUS 6
6W IP44



PLEXUS 10
10W IP44



PLEXUS 724
7W IP44



PLEXUS 6 UGR
6W IP44



PLEXUS 10 UGR
10W IP44



PLEXUS 724 UGR
7W IP44



TIO
7W IP40



RAÛL 10
10W IP40



TIO UGR
7W IP40



RAÛL 10 UGR
10W IP40



MINE 6
6W IP20



MINE 10
10W IP20



MINE 20
20W IP20



LOLLO 10
10W IP20



LOLLO X120
2x10W IP20



LOLLO X130
3x10W IP20



LOLLO 20
20W IP20

ADJUSTABLE DOWNLIGHTS



LOLLO X220
2x20W IP20



LOLLO X230
3x20W IP20



MINILED A R10
3W IP20



MINILED A Q10
3W IP20

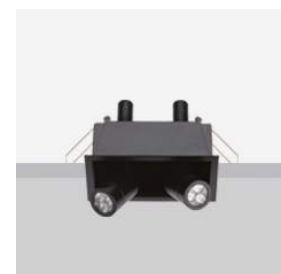

MINILED A QX120
2x3W IP20



MINILED A QX130
3x3W IP20



LEDA R10
10W IP20



LEDA Q10
10W IP20



LEDA QX120
2x10W IP20



LEDA QX130
3x10W IP20

STEPLIGHTS



SOREL
1-2W IP65

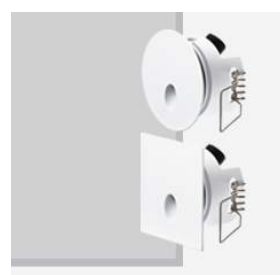

UMA
1W IP40



BEAN
1W IP67



BANG
1-2W IP20



DAGO 2
1-2W IP40



DAGO 6
3-6W IP40



KIRSTEN
5W IP65



BRAD
5W IP65

TRIMLESS PROJECTORS

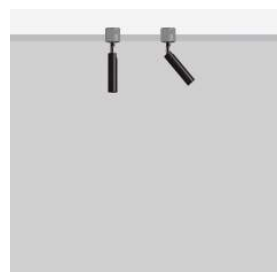

MINIJOS F2
2W IP20



MINIJOS F6
6W IP20



MINIJOS F10
10W IP20

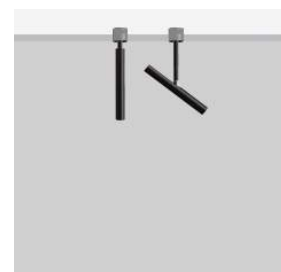

JOS F2
2W IP20



JOS F6
6W IP20



JOS F10
10W IP20

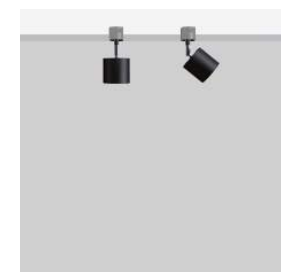

LAD F6
6W IP20



LAD F10
10W IP20

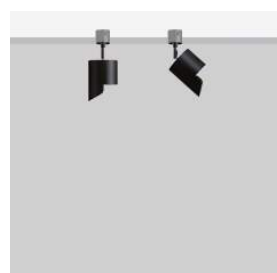

LAD F10 WW
10W IP20

SEMI-RECESSED PROJECTORS



MINIJOS R2
2W IP20



MINIJOS R6
6W IP20



MINIJOS R10
10W IP20



JOS R2
2W IP20



JOS R6
6W IP20



JOS R10
10W IP20



LAD R6
6W IP20



LAD R10
10W IP20

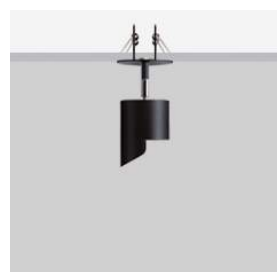

LAD R10 WW
10W IP20

SURFACE PROJECTORS

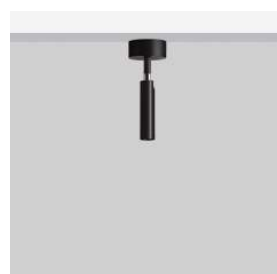

MINIJOS S2
2W IP20

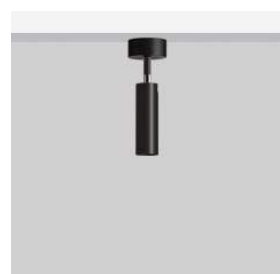

MINIJOS S6
6W IP20



MINIJOS S10
10W IP20



JOS S2
2W IP20



JOS S6
6W IP20



JOS S10
10W IP20



LAD S6
6W IP20



LAD S10
10W IP20



LAD S10 WW
10W IP20



BULL 10 BASE
10W IP20



BULL 20 BASE
20W IP20



BULL 40 BASE
40W IP20

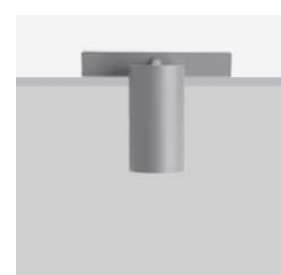

BULL 10 LAY
10W IP20

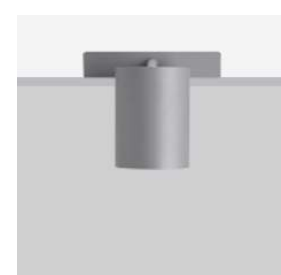

BULL 20 LAY
20W IP20



BULL 40 LAY
40W IP20



MINISASHA 110D
3W IP20



MINISASHA 130D
3x3W IP20



MINISASHA 110U
3W IP20



MINISASHA 130U
3x3W IP20

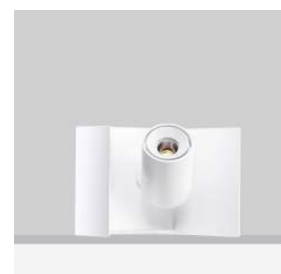

SASHA 110D
8W IP20



SASHA 120D
2x8W IP20



SASHA 130D
3x8W IP20



SASHA 150D
5x8W IP20



SASHA 110U
8W IP20

SURFACE PROJECTORS



SASHA 120U
2x8W IP20



SASHA 130U
3x8W IP20



SASHA 150U
5x8W IP20

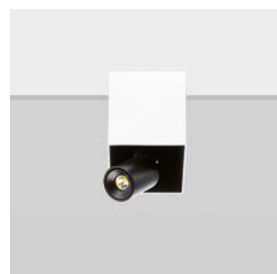

SWAN 10
10W IP20



SWAN X120
2x10W IP20



SWAN X130
3x10W IP20



TULIP
10W IP20



CRIS
3-6W IP20



PUFF
2W IP20

TRIMLESS PENDANTS



GAGARIN PT2
2W IP20



GAGARIN PT6
6W IP20



GAGARIN PT10
10W IP20



JOS PT2
2W IP20



JOS PT6
6W IP20



JOS PT10
10W IP20

SEMI-RECESSED PENDANTS



GAGARIN PR2
2W IP20



GAGARIN PR6
6W IP20



GAGARIN PR10
10W IP20



JOS PR2
2W IP20



JOS PR6
6W IP20



JOS PR10
10W IP20

PENDANTS



GAGARIN PS2
2W IP20



GAGARIN PS6
6W IP20



GAGARIN PS10
10W IP20



JOS PS2
2W IP20



JOS PS6
6W IP20



JOS PS10
10W IP20

LINEAR SYSTEMS



230VAC TRACK



BULL 10
10W IP20



BULL 20
20W IP20



BULL 40
40W IP20



**BULL 10
PRECISION**
10W IP20



**BULL 20
PRECISION**
20W IP20



BULL 10 FOCUS
10W IP20



BULL 20 FOCUS
20W IP20

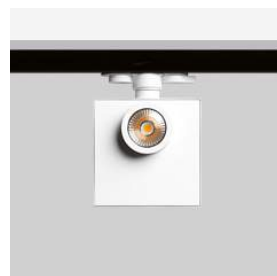

ABRAHM 1020
10-20W IP20



ABRAHM 3040
30-40W IP20

LINEAR SYSTEMS



24VDC TRACK



**24VDC
TRIMLESS TRACK**



MINIJOS T2
2W IP20



MINIJOS T6
6W IP20



MINIJOS T10
10W IP20



JOS T2
2W IP20



JOS T6
6W IP20



JOS T10
10W IP20



LAD T6
6W IP20



LAD T10
10W IP20

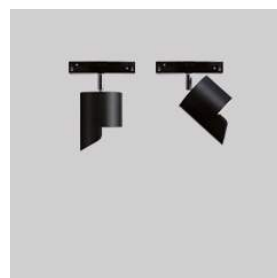

LAD T10 WW
10W IP20



JOS T2P
2W IP20



JOS T6P
6W IP20



JOS T10P
10W IP20

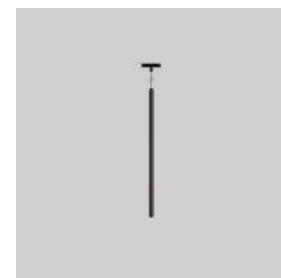

GAGARIN T2
2W IP20



GAGARIN T6
6W IP20

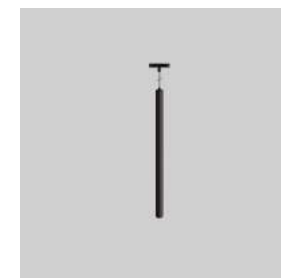

GAGARIN T10
10W IP20

LINEAR SYSTEMS

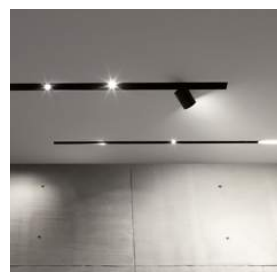

MAGGY 36



LEONARD 36
5W IP20



DAVID 36
10W IP20



PRINCE 36
10W IP20



BEN 36
15W IP20

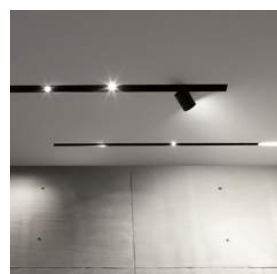

MAGGY 72



LEONARD 72
10W IP20



DAVID 72
20W IP20



PRINCE 72
20W IP20



BEN 72
30W IP20

LINEAR SYSTEMS



OCTO CEILING



OCTO PENDANT



JOS X2
2W IP20



JOS X6
6W IP20



JOS X10
10W IP20



LAD X6
6W IP20



LAD X10
10W IP20



LAD X10 WW
10W IP20



LEV X7
7W IP20



LEV X14
14W IP20

CEILING AND WALL MOUNTED LUMINAIRES

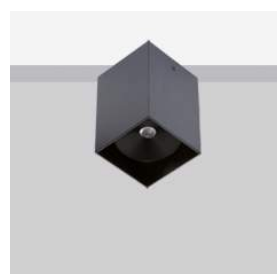

ARIK 2
1-2W IP40 IP44



ARIK 6
3-6W IP40 IP44



ARIK 10
10W IP40 IP44



TUBE 6
6W IP40 IP44



KOINE 2
1-2W IP40 IP44



KOINE 6
3-6W IP40 IP44



KOINE 10
10W IP40 IP44



CUBE 2030
20-30W IP20



ELF 2
1-2W IP65



ELF 6
3-6W IP65



ELF 10
10W IP65



ELF 724
7W IP65



ART
7W IP65



SASABUNE
10W IP65

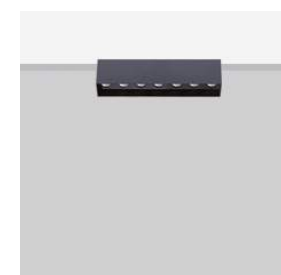

LEV S7
7W IP20



LEV S14
14W IP20



KELLER S
7W IP65



KELLER D
2x7W IP65



MARUPE 12
6-12W IP40 IP44



GAGA
20W IP40



HULA
6W IP65

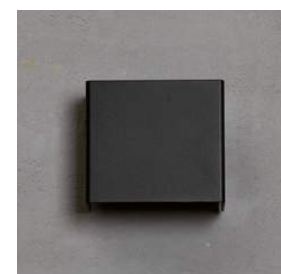

CADMO 6
6-12W IP65

IP RATED DOWNLIGHTS



PUCK
1W IP67



TYTUS
1W IP67



TYZAN
1W IP67



HANS
1W IP67

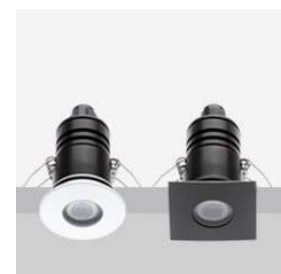

LOTUS 2
1-2W IP67



LOTUS 6
3-6W IP67



LOTUS 6 EVO
6W IP67



BABUS 2
1-2W IP67



BABUS 6
3-6W IP67



BABUS 6 EVO
6W IP67



ZERUS 2
1-2W IP67



ZERUS 6
3-6W IP67



ZERUS 6 EVO
6W IP67



FLY 6
6W IP67



FLY 10
10W IP67



FLY 724
7W IP67



ALPHA 2
1-2W IP67



ALPHA 10
10W IP67



BETA 2
1-2W IP67



MAE 2
1-2W IP67

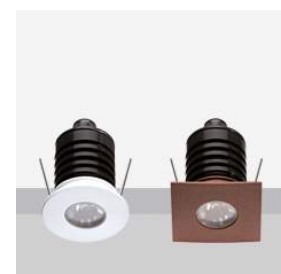

GREG
2W IP67



JUPITER
7W IP67



VENUS
7W IP67



ERIS
7W IP67

IP RATED DOWNLIGHTS



WOTAN 5
5W IP67

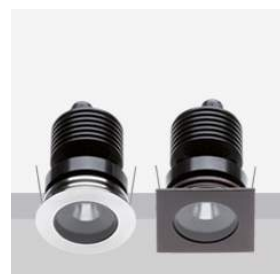

WOTAN 10
10W IP67



WOTAN 20
20W IP67



BATAN 5
5W IP67



BATAN 10
10W IP67



ZETAN 5
5W IP67



ZETAN 10
10W IP67



SLOT 2
1-2W IP67



SLOT 6
3-6W IP67

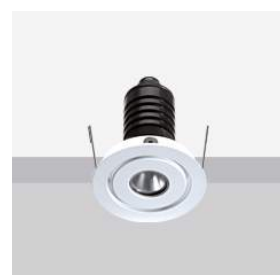

SLOT 6 EVO
6W IP67



SLOT 724
7W IP67



SLOT 10
10W IP67



TYRONE 2
1-2W IP67



TYRONE 6
3-6W IP67



TYRONE 6 EVO
6W IP67



TYRONE 724
7W IP67



TYRONE10
10W IP67

UPLIGHTS AND PATHLIGHTS



TYLA
1W IP67



LANDA
1W IP67



FATBOY 2
1-2W IP67



FROG
2W IP67



TERA 2
1-2W IP67



TERA 6
3-6W IP67



TERA 6 EVO
6W IP67



TERA 7
7W IP67



TERA 524
6W IP67



DIG 6
6W IP67



DIG 10
10W IP67



DIG 724
7W IP67



GLASS 2
1-2W IP67



GLASS 6
3-6W IP67



GLASS 524
6W IP67



GLASS 724
7W IP67



JAN 2
1-2W IP67



JAN 10
10W IP67



BREE
7W IP67



DESERT 5
5W IP67



DESERT 10
10W IP67



DESERT 20
20W IP67



JENA 2
1-2W IP67



JENA 6
3-6W IP67



MAL 10
10W IP67



MAL 20
20W IP67

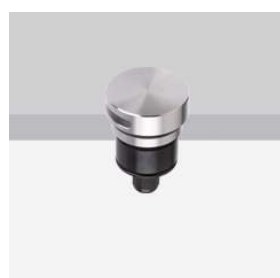

BUNGA
1-2W IP67



MINIAIR
1-2W IP67



AIR 6
3-6W IP67



KING
3-6W IP67

IP RATED PROJECTORS

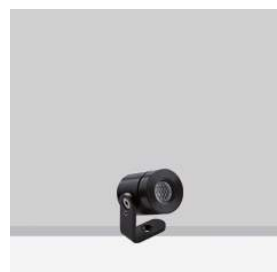

YAGA
1-2W IP65



CASSIUS
2W IP65



MAHALO
7W IP65



MAUNA 6
6W IP65



MAUNA 724
7W IP65



OLU 2
1-2W IP65



OLU 6
3-6W IP65



BRUTUS 10
10W IP65



BRUTUS 20
20W IP65



ALOHA 2
1-2W IP65



ALOHA 6
3-6W IP65



ALOHA 14
7-14W IP65



ALOHA 524
6W IP65



ZOOM
1-2W IP65



ZOOM 10
10W IP65



CLIO 10
10W IP65



CLIO 20
20W IP65



POLE



OLU 6 POLE
3-6W IP65



MAHALO POLE
7W IP65

BOLLARDS



ELLE 2
1-2W IP65



ELLE 6
3-6W IP65



SIGN
5W IP65



DIDO
8,2W IP65



DUSK
8,2W IP65

RGB COLOR CHANGING SYSTEM



COLOR
3x1W IP65



SINTRA
3x1W IP65



ZERO R RGB
3x1W IP44



ZERO Q RGB
3x1W IP44



DAGO RGB
3x1W IP40

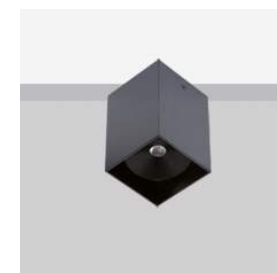

ARIK RGB
3x1W IP44



KOINE RGB
3x1W IP44



MARUPE RGB
3x1W IP44



CADMO RGB
3x1W IP65



TERA RGB
3x1W IP67



JENA RGB
3x1W IP67



AIR RGB
3x1W IP67



ALOHA RGB
3x1W IP65



ELLE RGB
3x1W IP65

POWER SUPPLIES, CONTROL SYSTEMS & SPECIAL ACCESSORIES

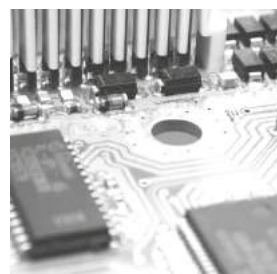

DRIVERS



**CONNECTION
SYSTEMS**



**RECESSING BOXES
FOR CONCRETE
CONSTRUCTIONS**

- ▶ Abrahm
- ▶ Adan
- ▶ Air
- ▶ Air RGB
- ▶ Aloha
- ▶ Aloha RGB
- ▶ Alpha
- ▶ Andrew
- ▶ Arik
- ▶ Arik RGB
- ▶ Art
- ▶ Baba
- ▶ Babus
- ▶ Bang
- ▶ Batan
- ▶ Bean
- ▶ Belem
- ▶ Beta
- ▶ Black
- ▶ Brad
- ▶ Bree
- ▶ Brutus
- ▶ Bull
- ▶ Bull Base
- ▶ Bull Focus
- ▶ Bull Lay
- ▶ Bull Precision
- ▶ Bunga
- ▶ Bye
- ▶ Cadmo
- ▶ Cadmo RGB
- ▶ Cassius
- ▶ Charles
- ▶ Clio
- ▶ Connection systems
- ▶ Color
- ▶ Core
- ▶ Cris
- ▶ Cube
- ▶ Dago
- ▶ Dago RGB
- ▶ Dahlia
- ▶ Desert
- ▶ Diddi
- ▶ Dido
- ▶ Dig
- ▶ Dusk
- ▶ Drivers
- ▶ Elf
- ▶ Elle
- ▶ Elle RGB
- ▶ Eris
- ▶ Fatboy
- ▶ Flexus
- ▶ Fly
- ▶ Franny
- ▶ Frog
- ▶ Gaga
- ▶ Gagarin PR
- ▶ Gagarin PS
- ▶ Gagarin PT
- ▶ Gagarin T
- ▶ Glass
- ▶ Greg
- ▶ Hans
- ▶ Hap
- ▶ Hero
- ▶ Hole
- ▶ Hula
- ▶ Jan
- ▶ Jena
- ▶ Jena RGB
- ▶ Jimbo
- ▶ Joel
- ▶ Jos F
- ▶ Jos PR
- ▶ Jos PS
- ▶ Jos PT
- ▶ Jos R
- ▶ Jos S
- ▶ Jos T
- ▶ Jos TP
- ▶ Jos X
- ▶ Juno
- ▶ Jupiter
- ▶ Keller
- ▶ King
- ▶ Kirsten
- ▶ Koine
- ▶ Koine RGB
- ▶ Kol
- ▶ Kurt
- ▶ Lad F
- ▶ Lad R
- ▶ Lad S
- ▶ Lad T
- ▶ Lad X
- ▶ Landa
- ▶ Leaf
- ▶ Leaf UGR
- ▶ Leda
- ▶ Lev S
- ▶ Lev X
- ▶ Lollo
- ▶ Loren
- ▶ Lotus
- ▶ Macaia
- ▶ Mae
- ▶ Maggy 36
- ▶ Maggy 72
- ▶ Mahalo
- ▶ Mal
- ▶ Marupe
- ▶ Marupe RGB
- ▶ Mauna
- ▶ Milo
- ▶ Mine
- ▶ Miniair
- ▶ Minijos F
- ▶ Minijos R
- ▶ Minijos S
- ▶ Minijos T
- ▶ Minileda
- ▶ Minisasha
- ▶ Moon
- ▶ Nap

- ▶ Neil
- ▶ None
- ▶ Octo Ceiling
- ▶ Octo Pendant
- ▶ Olu
- ▶ Plexus
- ▶ Plexus UGR
- ▶ Pole
- ▶ Puck
- ▶ Puff
- ▶ Raül
- ▶ Raül Trimless
- ▶ Raül UGR
- ▶ Recessing Boxes
- ▶ Sasabune
- ▶ Sasha
- ▶ Selene
- ▶ Sexus
- ▶ Sexus UGR
- ▶ Sintra
- ▶ Sign
- ▶ Slot
- ▶ Sky
- ▶ Sorel
- ▶ Swan
- ▶ Tag
- ▶ Task
- ▶ Tera
- ▶ Tera RGB
- ▶ Tio
- ▶ Tio Trimless
- ▶ Tio UGR
- ▶ Tube
- ▶ Tulip
- ▶ Tyla
- ▶ Tyrone
- ▶ Tytus
- ▶ Tyzan
- ▶ Uma
- ▶ Venus
- ▶ Wolf
- ▶ Wotan
- ▶ Yaga
- ▶ Zed
- ▶ Zerino
- ▶ Zero
- ▶ Zero Move
- ▶ Zero RGB
- ▶ Zerus
- ▶ Zetan
- ▶ Zoe
- ▶ Zoom
- ▶ 230VAC Track
- ▶ 24VDC Track



Our value

People whose commitment and dedication can bring an innovative manufacturing project to fruition: this is our most genuine asset. Founded in 2010 by Roberto Mantovani, a designer with experience in product and lighting design, Flexalighting has grown over time, enriched by staff who are attentive, intelligent and open to new challenges. Our resources have enabled us to develop a wide range of LED lighting devices for interiors and exteriors, all entirely Made in Italy, for applications ranging from residential to retail, hospitality and service areas. Products in which meticulous attention to reliability and optical and structural quality is translated into high-level lighting solutions that can innovate the world of professional lighting.

Il nostro valore

Persone che con l'impegno e la dedizione danno concretezza ad un progetto industriale innovativo: questa è la nostra sostanza più autentica. Fondata nel 2010 da Roberto Mantovani, designer con esperienze nel mondo del design di prodotto e del lighting design, Flexalighting è cresciuta negli anni arricchendosi di un personale attento, intelligente, sensibile alle sfide. Grazie alle nostre risorse abbiamo sviluppato un'ampia gamma di apparecchi di illuminazione a LED per interni ed esterni, completamente made in Italy, per applicazioni che spaziano dal residenziale al retail, hospitality, spazi terziari. Prodotti nei quali una grande attenzione alla qualità ottica e costruttiva ed all'affidabilità si traduce in soluzioni di luce di alto livello, capaci di innovare il mondo dell'illuminazione professionale.

Notre valeur

Des personnes qui, grâce à leur engagement et leur dévouement ont su concrétiser un projet industriel novateur: c'est cela qui constitue notre substance la plus authentique. La Société Flexalighting, fondée en 2010 par Roberto Mantovani, designer de grande expérience dans le monde du design de produit et du lighting design, a grandi au cours des années et s'est enrichie d'un personnel consciencieux, capable et sensible aux défis. Notre patrimoine humain nous a permis de développer une vaste gamme d'appareils d'éclairage à LED d'intérieurs et d'extérieurs, totalement made in Italy, avec des applications allant du résidentiel au retail, à l'hospitality, aux espaces tertiaires. Produits auxquels on a consacré une grande attention quant à la qualité optique et de construction mais aussi à l'efficacité, ce qui traduit dans des solutions de lumière de haut niveau, capables d'innover le monde de l'éclairage professionnel.

Unser Wert

Personen, die mit Engagement und Hingabe ein innovatives Industrieprojekt konkretisieren: dies ist unsere authentische Substanz. Im Jahr 2010 von Roberto Mantovani gegründet, einem Designer mit Erfahrung in Produktdesign und Lighting Design, ist Flexalighting in den Jahren gewachsen und wird bereichert durch ein aufmerksames, intelligentes Personal, das den Herausforderungen gerecht wird. Dank unseres menschlichen Erbes haben wir eine breite Palette an LED-Leuchten für Innen- und Außenbereiche entwickelt, komplett Made in Italy, für Anwendungen, die von Wohnungen bis Retail, Hospitality und dem Dienstleistungsbereich reichen. Produkte, bei denen sich eine große Aufmerksamkeit auf die optische und bauliche Qualität sowie auf die Zuverlässigkeit, in Licht-Lösungen mit hohem Niveau umsetzen, die die Welt der professionellen Beleuchtung erneuern können.

Nuestro valor

Personas que con empeño y dedicación concretan un proyecto industrial innovador: esta es nuestra mejor y más auténtica idea. Fundada en 2010 por Roberto Mantovani, diseñador con experiencia en el mundo del diseño de productos y del diseño de iluminación, Flexalighting ha crecido con el paso de los años enriqueciéndose con un personal atento, inteligente, sensible con los desafíos. Gracias a nuestro patrimonio humano hemos desarrollado una gama amplia de aparatos de iluminación con LED para interiores y exteriores, completamente realizados en Italia, para aplicaciones que van de las zonas residenciales a los minoristas, espacios terciarios y sector hospitalario. Productos en los cuales una gran atención a la calidad óptica y constructiva y a la fiabilidad se traduce en soluciones de luz de alto nivel, capaces de innovar el mundo de la iluminación profesional.



Minimize dimensions, maximise performance

Flexalighting arose from LED technology, and the aim is to fully exploit its most important and exclusive properties: efficiency, durability, but above all, dimensions. One of the most obvious things about a LED: it's tiny. And this has opened up new possibilities for product research: we want to build light into architecture, we want to reduce the compositional impact of lighting devices. When all is said and done, we want to offer light in its purest form.

Optical and manufacturing quality

Optical quality and manufacturing quality combine in high-level products: from scrupulous control of metal alloys and processing, to the selection of materials not subject to deterioration, to the use of the latest generation thermal interfaces, reliable, high-performance LEDs and optical trains of utmost optical quality: the technological mastery allows Flexalighting to manufacture products of the highest quality level.

Minimizzare le dimensioni, massimizzare le prestazioni

Flexalighting è nata intorno alla tecnologia LED, per sfruttarne appieno le proprietà più importanti ed esclusive: efficienza, durata, ma soprattutto dimensioni. Una delle peculiarità più evidenti del LED: è piccolo. E questo ha aperto nuove prospettive alla ricerca di prodotto: vogliamo integrare luce ed architettura, vogliamo ridurre l'impatto compositivo degli apparecchi di illuminazione. In fin dei conti, vogliamo offrire la luce nella sua purezza.

Qualità ottica e costruttiva

Qualità ottica e qualità costruttiva si combinano in prodotti di alto livello: dal controllo scrupoloso delle leghe metalliche e delle lavorazioni, alla scelta di materiali non soggetti a decadimento, all'impiego di interfacce termiche di ultima generazione, all'impiego di LED affidabili e performanti e di treni ottici della massima qualità ottica: la padronanza tecnologica permette a Flexalighting di produrre apparecchi del più elevato livello qualitativo.

Minimiser les dimensions, maximiser les prestations

Flexalighting a été créée autour de la technologie LED afin d'exploiter pleinement ses propriétés les plus importantes et exclusives: efficacité, durée, mais surtout dimensions. Une des plus grandes particularités du LED: c'est qu'il est petit. Et cela a ouvert de nouvelles perspectives en termes de recherche de produit: nous souhaitons intégrer la lumière et l'architecture, nous souhaitons réduire l'impact de composition des appareils d'éclairage. Pour tout dire, nous souhaitons offrir la lumière dans toute sa pureté.

Qualité optique et qualité constructive

Qualité optique et qualité constructive se combinent en produits de haut niveau: du contrôle scrupuleux des alliages métalliques et des usinages, au choix de matériaux non sujets à dégradation, en passant par l'emploi d'interfaces thermiques de dernière génération, à l'emploi de LED fiables et performants et de trains optiques de la qualité optique maximale: la maîtrise technologique permet à Flexalighting de produire des appareils du meilleur niveau qualitatif.

Minimierung der Abmessungen, Maximierung der Leistungen

Flexalighting ist rund um die LED-Technologie entstanden, um voll und ganz von deren wichtigsten und exklusivsten Vorteilen zu profitieren: Effizienz, Haltbarkeit, aber vor allem Abmessungen. Eine der bemerkenswertesten Eigenschaften des LED: es ist klein. Und dies hat der Produktforschung neue Perspektiven eröffnet: wir möchten Licht und Architektur integrieren, wir möchten die Auswirkung der Zusammensetzung der Leuchten reduzieren. Schließlich möchten wir das Licht in seiner Reinheit anbieten.

Optische Qualität und konstruktive Qualität

Optische Qualität und konstruktive Qualität sind in hochqualitativen Produkten kombiniert: die gewissenhafte Kontrolle von Metalllegierungen und Verarbeitungen, die Auswahl von Materialien, die keinem Verfall unterliegen, die Verwendung der neuesten Generation von thermischen Schnittstellen, die Verwendung zuverlässiger und funktionstüchtiger LED und optische Züge mit maximaler optischer Qualität: Technologische Kompetenz ermöglicht es Flexalighting Geräte von höchster Qualität zu produzieren.

Minimizar las dimensiones, maximizar las prestaciones

Flexalighting surgió en torno a la tecnología LED, para aprovechar completamente las propiedades más importantes y exclusivas: eficiencia, duración, pero, sobre todo, dimensiones. Una de las peculiaridades más evidentes del LED: es pequeño. Esto ha abierto nuevas perspectivas en la investigación del producto: queremos integrar la luz y la arquitectura, queremos reducir el impacto compositivo de los aparatos de iluminación. En resumen, queremos ofrecer la luz con toda su pureza.

Calidad óptica y calidad constructiva

Calidad óptica y calidad constructiva se combinan en productos de alto nivel: desde el control escrupuloso de las aleaciones metálicas y de los procesos, pasando por la selección de materiales no sujetos a corrosión, la utilización de interfaces térmicas de última generación, hasta llegar al empleo de LEDs fiables y eficientes y de trenes ópticos de la máxima calidad óptica: la maestría tecnológica permite a Flexalighting fabricar aparatos del más alto nivel cualitativo.



**Flexalighting North America:
designed in Italy and built
in Canada for the North
American market**

To offer a fast, effective service that responds to the specific needs of the North American market, Flexalighting opened a production plant in the area of Vancouver, BC, Canada in 2017, where catalogue products are produced in compliance with ETL certifications. In continuous contact with the Italian parent company, Flexalighting North America develops a wide range of products able to meet Canadian and US installation standards, offering maximum technical and commercial assistance to customers.

**Flexalighting North America:
disegnato in Italia e costruito
in Canada per il mercato
nordamericano**

Per offrire un servizio rapido, efficace ed in grado di rispondere alle esigenze specifiche del mercato nordamericano, Flexalighting ha aperto, nel 2017, uno stabilimento di produzione nell'area di Vancouver, BC, Canada, nel quale vengono realizzati i prodotti del catalogo nel rispetto delle certificazioni ETL. In continuo contatto con la casa madre italiana, Flexalighting North America sviluppa un'ampia offerta in grado di rispondere agli standard di installazione canadesi e statunitensi, offrendo la massima assistenza tecnica e commerciale alla clientela.

**Flexalighting North America:
dessiné en Italie et fabriqué
au Canada pour le marché
nord-américain**

Afin d'offrir un service rapide, efficace et capable de répondre aux exigences spécifiques du marché nord-américain, Flexalighting a ouvert, en 2017, une usine de production dans la zone de Vancouver, BC, Canada, où sont réalisés les produits du catalogue dans le respect des certifications ETL. Constamment en contact avec la maison mère italienne, Flexalighting North America développe une vaste proposition capable de répondre aux standards d'installation canadiens et américains et d'offrir la meilleure assistance technique et commerciale à la clientèle.

**Flexalighting Nordamerika:
in Italien entwickelt und in
Kanada gebaut deckt sie den
nordamerikanischen Markt**

Ab um schnell, effektiv und in der Lage zu sein, auf die spezifischen Bedürfnisse des nordamerikanischen Marktes einzugehen, eröffnete Flexalighting 2017 eine Produktionsstätte im Raum Vancouver, BC, Kanada, wo die im Katalog aufgeführten Produkte nach ETL-Zertifizierungen hergestellt werden. Flexalighting North America ist in ständigem Kontakt mit der italienischen Muttergesellschaft und entwickelt eine breite Palette von Produkten, die den kanadischen und amerikanischen Installationsstandards entsprechen und den Kunden maximale technische und kommerzielle Unterstützung bieten.

**Flexalighting North America:
diseñado en Italia y fabricado
en Canadá para el mercado
norteamericano**

Con el fin de ofrecer un servicio rápido, eficaz y capaz de responder a las necesidades específicas del mercado norteamericano, Flexalighting inauguró, en 2017, una planta de producción en la zona de Vancouver, BC, Canadá, donde se fabrican los productos del catálogo de acuerdo con las certificaciones ETL. En contacto permanente con la casa matriz italiana, Flexalighting North America desarrolla una amplia gama de productos capaces de satisfacer las normas de instalación canadienses y norteamericanas, ofreciendo máxima asistencia técnica y comercial a los clientes.

SKY

design: Roberto Mantovani

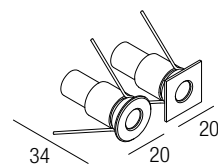

Supply current

Alimentazione
Courant d'alimentation
Stromversorgung
Corriente de alimentación
250 mA (V_i 2,9V)

Power

Potenza
Puissance
Bestuekung
Potencia
0,75 W

Series wiring

Cablaggio in serie
Câblage en série
Verkabelung in Serie
Cableado en serie



CCT/CRI/Flux

250mA
2700K — **71 lm**
3000K — **75 lm**
4200K — **86 lm**
6000K — **91 lm**

CRI85

2-Step MacAdam

Photometric diagrams

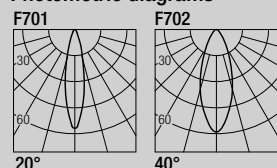

Code Construction

Costruzione del codice - Construction du code produit
Bau der Produkt-Code - Construcción del código de producto

SK X X X X

Color Temperature	0	1	2	3	6	7	8
Temperatura colore	2700K	3000K	4200K	6000K	Blue	Green	Red
Température couleur					Blu	Verte	Rosso
Temperaturabhängige Farbe					Bleu	Vert	Rouge
Temperatura de color					Blau	Grün	Rot
					Azul		Rojo

Beam angle	1	2
Apertura di fascio	20°	40°
Angle de faisceau		
Strahlwinkel		
Ángulo del haz		

Finishing	1	2	3	4	5	6	7
Finitura	White	Aluminium	Chrome	Gold	Black	Bronze	Titanium
Finitions	Bianco	Aluminium	Cromo	Oro	Nero	Bronzo	Titanio
Oberflächenfinish	Blanc	Aluminium	Chrom	Or	Noir	Bronce	Titane
Acabados	Weiß	Aluminio		Schwarz	Negro		Titan
	Blanco						

Shape	1	2
Forma	Round	Square
Forme	Tondo	Quadro
Form	Ronde	Carré
	Runde	Quadrat
	Redondo	Cuadrado

Accessories

Accessori - Accessoires
Zubehör - Accesorios

CS1008

Recessing box
Controcassa
Boîtier d'encastrement
Eingießgehäuse
Caja de empotrar

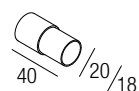

Drivers

Alimentatori - Alimentateurs
Netzteile - Alimentadores

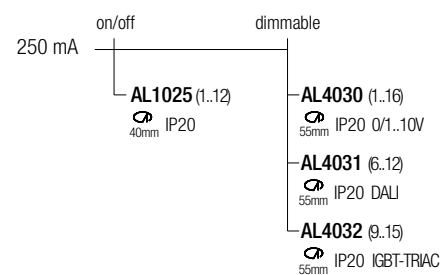

SELENE

design: Roberto Mantovani

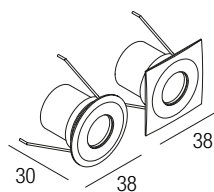

Supply current

Alimentazione
Courant d'alimentation
Stromversorgung
Corriente de alimentación
350-500 mA (V_i 2,9V)

Power

Potenza
Puissance
Bestuekung
Potencia
1-2 W

Series wiring

Cablaggio in serie
Câblage en série
Verkabelung in Serie
Cableado en serie



Photometric diagrams

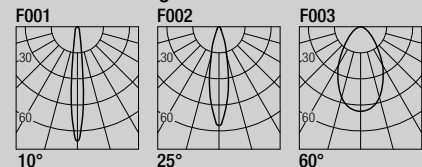

CCT/CRI/Flux

	350mA	500mA
2700K	89 lm	128 lm
3000K	93 lm	133 lm
4200K	103 lm	154 lm
6000K	114 lm	165 lm

CRI85

2-Step MacAdam

Code Construction

Costruzione del codice - Construction du code produit
Bau der Produkt-Code - Construcción del código de producto

SP X X X X

Color Temperature	0	1	2	3	6	7	8
Temperatura colore	2700K	3000K	4200K	6000K	Blue	Green	Red
Température couleur					Blu	Verte	Rosso
Temperaturabhängige Farbe					Bleu	Vert	Rouge
Temperatura de color					Blau	Grün	Rot
					Azul		Rojo

Beam angle	0	1	2
Apertura di fascio	10°	25°	60°
Angle de faisceau			
Strahlwinkel			
Ángulo del haz			

Finishing	1	2	3	4	5	6	7	9
Finitura	White	Aluminium	Chrome	Gold	Black	Bronze	Titanium	INOX
Finitions	Bianco	Aluminium	Chromo	Oro	Nero	Bronzo	Titanio	INOX
Oberflächenfinish	Blanc	Aluminium	Chrom	Or	Noir	Bronce	Titane	Steel
Acabados	Weiß	Aluminio	Chrom	Or	Schwarz	Bronce	Titan	Acciaio
	Blanco				Negro			Acier
								Stahl
								Acero

Shape	1	2
Forma	Round	Square
Forme	Tondo	Quadro
Form	Ronde	Carré
	Runde	Quadrat
	Redondo	Cuadrado

Drivers

Alimentatori - Alimentateurs
Netzteile - Alimentadores

350 mA		500 mA	
on/off	dimmable	on/off	dimmable
AL1034 (1..11) 30mm IP20	AL4000 (1..12) 72mm IP20 PUSH 0/1..10V	AL1074 (1..7) 30mm IP20	AL4010 (1..12) 72mm IP20 PUSH 0/1..10V
AL1035 (1..11) 40mm IP20	AL4051 (2..14) 72mm IP20 DALI 2	AL1077 (1..6) 40mm IP20	AL4151 (2..14) 72mm IP20 DALI 2
AL1037 (1..16) 55mm IP20 S.P.	AL4053 (1..14) 56mm IP20 PUSH IGBT-TRIAC	AL1084 (1..11) 55mm IP20 S.P.	AL4153 (1..14) 56mm IP20 PUSH IGBT-TRIAC
AL9011 (1..12) 44mm IP67	AL8035 (4..16) IP67 DALI	AL9051 (1..11) 44mm IP67	AL8050 (4..16) IP67 DALI

Accessories

Accessori - Accessoires
Zubehör - Accesorios

CS1001

Recessing box
Controcassa
Boîtier d'encastrement
Eingieβgehäuse
Caja de empotrar

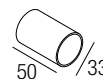

CS1006

Recessing box
Controcassa
Boîtier d'encastrement
Eingieβgehäuse
Caja de empotrar

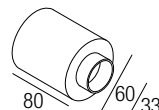

AL7022

24VDC/500mA constant current converter
Convertitore 24VDC/500mA corrente costante
Convertisseur 24VDC/500mA courant constant
24VDC/500mA konstanter Strom konverter
Convertidor 24VDC/500mA corriente constante



KOL

design: Roberto Mantovani

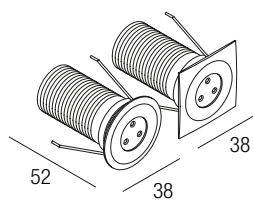

Supply current

Alimentazione
Courant d'alimentation
Stromversorgung
Corriente de alimentación
350-500 mA (V, 8,7V)

Power

Potenza
Puissance
Bestuekung
Potencia
3-6 W

Series wiring

Cablaggio in serie
Câblage en série
Verkabelung in Serie
Cableado en serie



CCT/CRI/Flux

	350mA	500mA
2700K	267 lm	384 lm
3000K	279 lm	400 lm
4200K	309 lm	462 lm
6000K	342 lm	495 lm

CRI85

2-Step MacAdam

Photometric diagrams

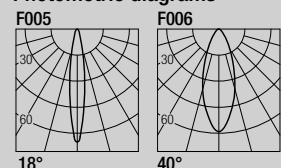

Code Construction

Costruzione del codice - Construction du code produit
Bau der Produkt-Code - Construcción del código de producto

PW X X X X

Color Temperature

0	1	2	3	6	7	8
2700K	3000K	4200K	6000K	Blue	Green	Red
Température couleur	Température couleur	Température couleur	Température couleur	Bleu	Vert	Rouge
Temperaturabhängige Farbe	Temperaturabhängige Farbe	Temperaturabhängige Farbe	Temperaturabhängige Farbe	Blau	Grün	Rot
Temperatura de color	Temperatura de color	Temperatura de color	Temperatura de color	Azul	Grün	Rojo

Beam angle

1	2
18°	40°
Apertura di fascio	Apertura di fascio
Angle de faisceau	Angle de faisceau
Strahlwinkel	Strahlwinkel
Ángulo del haz	Ángulo del haz

Finishing

1	2	3	4	5	6	7	9
White	Aluminium	Chrome	Gold	Black	Bronze	Titanium	INOX
White	Aluminium	Chrome	Gold	Black	Bronze	Titanium	INOX
Blanc	Aluminium	Chrom	Or	Noir	Bronce	Titane	Steel
Weiß	Aluminium	Chrom	Or	Schwarz	Bronce	Titan	Acciaio
Blanco	Aluminio	Chrom	Or	Negro	Bronce	Titan	Acier
							Stahl
							Acero

Shape

1	2
Round	Square
Tondo	Quadro
Ronde	Carré
Runde	Quadrat
Redondo	Cuadrado

Drivers

Alimentatori - Alimentateurs
Netzteile - Alimentadores

350 mA		500 mA	
on/off	dimnable	on/off	dimnable
AL1034 (1..3) 30mm IP20	AL4000 (1..4) 72mm IP20 PUSH 0/1..10V	AL1074 (1..2) 30mm IP20	AL4010 (1..4) 72mm IP20 PUSH 0/1..10V
AL1035 (1..3) 40mm IP20	AL4051 (1..4) 72mm IP20 DALI 2	AL1077 (1..2) 40mm IP20	AL4151 (1..4) 72mm IP20 DALI 2
AL1037 (1..5) 55mm IP20 S.P.	AL4053 (1..4) 56mm IP20 PUSH IGBT-TRIAC	AL1084 (1..3) 55mm IP20 S.P.	AL4153 (1..4) 56mm IP20 PUSH IGBT-TRIAC
AL9011 (1..4) 44mm IP67	AL8035 (2..4) IP67 DALI	AL9051 (1..3) 44mm IP67	AL8050 (2..4) IP67 DALI

Accessories

Accessori - Accessoires
Zubehör - Accesorios

CS1002

Recessing box
Controcassa
Boîtier d'encastrement
Eingieβgehäuse
Caja de empotrar

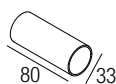

CS1006

Recessing box
Controcassa
Boîtier d'encastrement
Eingieβgehäuse
Caja de empotrar

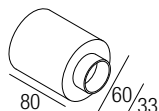

LPW01

Low luminance louver
Filtro antiabbagliamento
Filtre basse luminance
Geringe Leuchtdichte-Filter
Filtro de baja luminancia



SPW01

Milky screen
Schermo opale
Écran opale
Opal-Bildschirm
Pantalla opal



Note: the filter and the screen must be ordered together with the lighting fixture - **Nota:** il filtro e lo schermo devono essere ordinati congiuntamente all'apparecchio - **Note:** le filtre et l'écran doivent être commandées en même temps que l'appareil
Anmerkung: müssen der Filter und der Bildschirm zusammen mit Leuchtkörper bestellt werden
Nota: el filtro y la pantalla deben pedirse juntos con la luminaria

AL7022

24VDC/500mA constant current converter
Convertitore 24VDC/500mA corrente costante
Convertisseur 24VDC/500mA courant constant
24VDC/500mA konstanter Strom konverter
Convertidor 24VDC/500mA corriente constante



KOL EVO

design: Roberto Mantovani

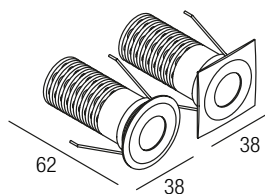

Supply current

Alimentazione
Courant d'alimentation
Stromversorgung
Corriente de alimentación

500 mA (V, 9V)

Power

Potenza
Puissance
Bestuekung
Potencia

6 W

Series wiring

Cablaggio in serie
Câblage en série
Verkabelung in Serie
Cableado en serie



CCT/CRI/Flux

2700K — 540 lm
3000K — 600 lm
4000K — 620 lm

Photometric diagrams

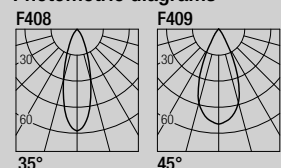

CRI98

2-Step MacAdam

Code Construction

Costruzione del codice - Construction du code produit
Bau der Produkt-Code - Construcción del código de producto

PWE X X X X

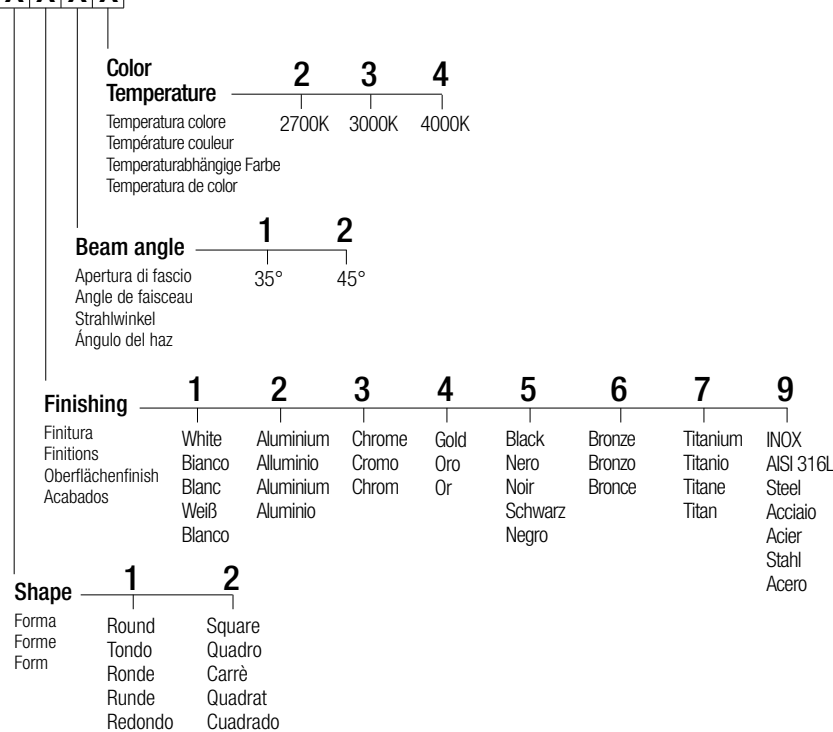

Accessories

Accessori - Accessoires
Zubehör - Accesorios

CS1006

Recessing box
Controcassa
Boîtier d'encastrement
Eingieβgehäuse
Caja de empotrar

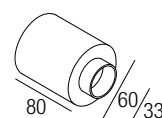

LPWE01

Low luminance louver
Filtro antiabbagliamento
Filtre basse luminance
Geringe Leuchtdichte-Filter
Filtro de baja luminancia



SPWE01

Milky screen
Schermo opale
Ecran opale
Opal-Bildschirm
Pantalla opal



Note: the filter and the screen must be ordered together with the lighting fixture - **Nota:** il filtro e lo schermo devono essere ordinati congiuntamente all'apparecchio - **Note:** le filtre et l'écran doivent être commandées en même temps que l'appareil
Anmerkung: müssen der Filter und der Bildschirm zusammen mit Leuchtkörper bestellt werden
Nota: el filtro y la pantalla deben pedirse juntos con la luminaria

AL7022

24VDC/500mA constant current converter
Convertitore 24VDC/500mA corrente costante
Convertisseur 24VDC/500mA courant constant
24VDC/500mA konstanter Strom konverter
Convertidor 24VDC/500mA corriente constante

Drivers

Alimentatori - Alimentateurs
Netzteile - Alimentadores

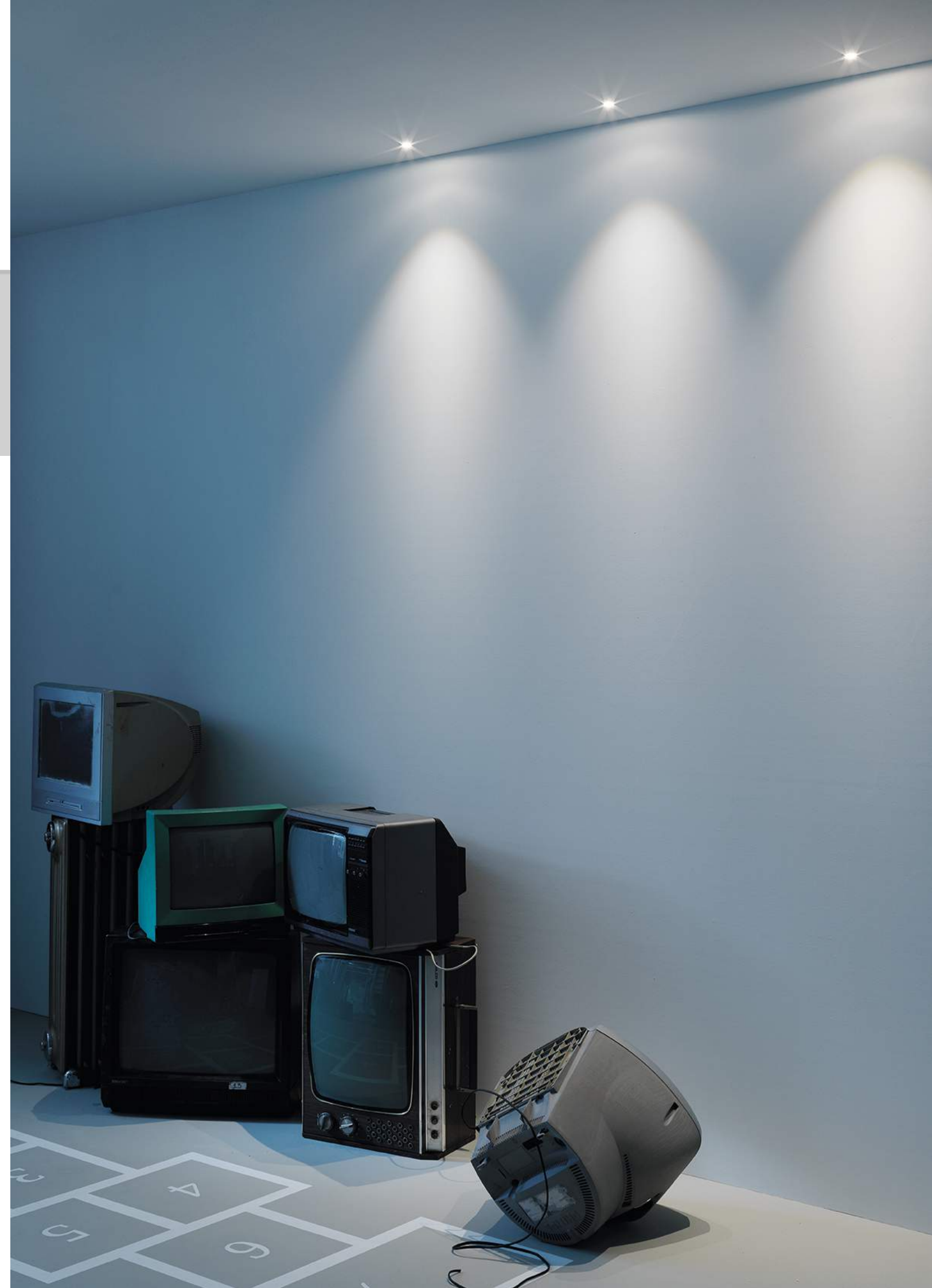
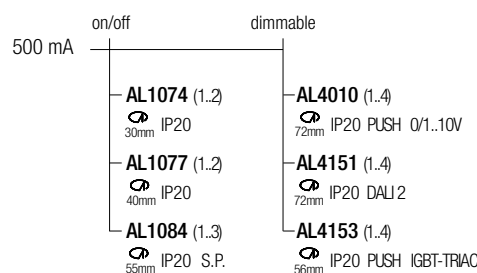

BELEM

design: Roberto Mantovani

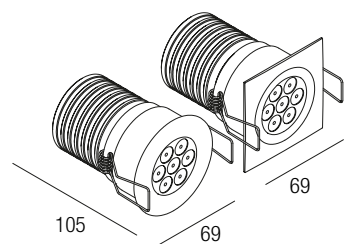

Supply current
 Alimentazione
 Courant d'alimentation
 Stromversorgung
 Corriente de alimentación
350-500 mA (V_I 20,3V)

Power
 Potenza
 Pouissance
 Bestuekung
 Potencia
7-14 W

Series wiring
 Cablaggio in serie
 Câblage en série
 Verkabelung in Serie
 Cableado en serie



CCT/CRI/Flux

	350mA	500mA
2700K	623 lm	896 lm
3000K	651 lm	931 lm
4200K	721 lm	1078 lm
6000K	798 lm	1155 lm

CRI85

2-Step MacAdam

Photometric diagrams

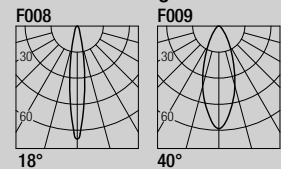

Code Construction

Costruzione del codice - Construction du code produit
 Bau der Produkt-Code - Construcción del código de producto

PZ X X X X

Color Temperature	0	1	2	3	6	7	8
Temperatura colore	2700K	3000K	4200K	6000K	Blue	Green	Red
Température couleur					Blu	Verte	Rosso
Temperaturabhängige Farbe					Bleu	Vert	Rouge
Temperatura de color					Blau	Grün	Rot
					Azul		Rojo

Beam angle	1	2
Apertura di fascio	18°	40°
Angle de faisceau		
Strahlwinkel		
Ángulo del haz		

Finishing	1	2	3	4	5	6	7
Finitura	White	Aluminium	Chrome	Gold	Black	Bronze	Titanium
Finitions	Bianco	Alluminio	Chrom	Oro	Nero	Bronze	Titane
Oberflächenfinish	Weiß	Aluminium	Chrom	Or	Schwarz	Bronce	Titan
Acabados	Blanco	Aluminio			Negro		

Shape	1	2
Forma	Round	Square
Forme	Tondo	Quadro
Form	Ronde	Carré
	Runde	Quadrat
	Redondo	Cuadrado

Drivers

Alimentatori - Alimentateurs
 Netzteile - Alimentadores

350 mA	on/off	dimmable
AL1034 (1)	30mm IP20	AL4000 (1)
AL1035 (1)	40mm IP20	AL4051 (1)
AL1037 (1..2)	55mm IP20 S.P.	AL4053 (1)
AL9011 (1)	44mm IP67	AL8035 (1..2)
		IP67 DALI

500 mA	on/off	dimmable
AL1074 (1)	30mm IP20	AL4010 (1)
AL1084 (1)	55mm IP20 S.P.	AL4151 (1)
AL9051 (1)	44mm IP67	AL4153 (1)
		AL8050 (1..2)
		IP67 DALI

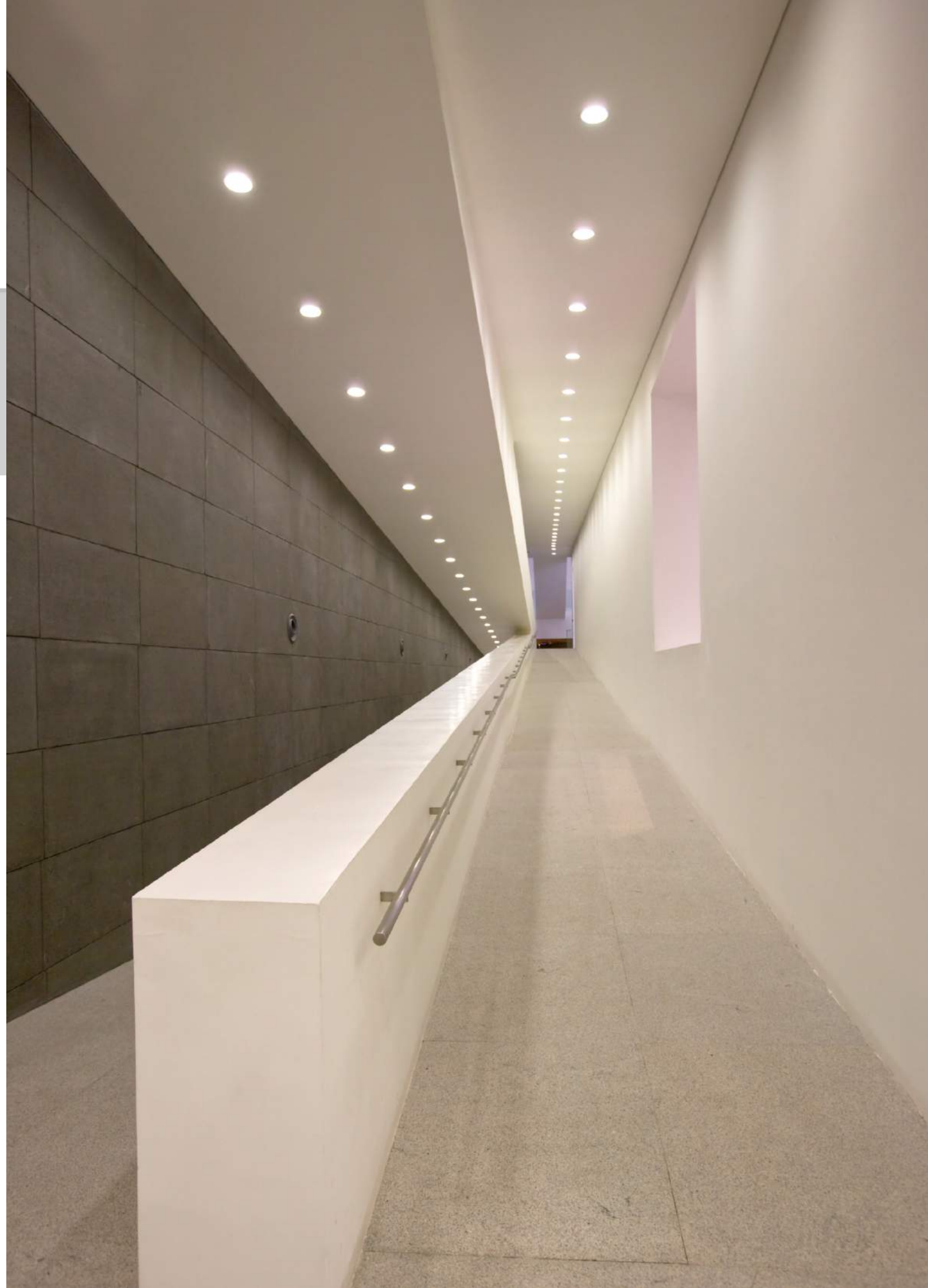

FLEXUS 6

design: Rod&Todd

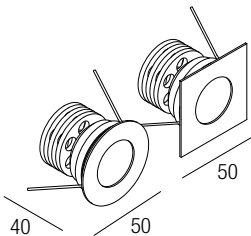

Supply current

Alimentazione
 Courant d'alimentation
 Stromversorgung
 Corriente de alimentación
500 mA (V, 9V)

Power

Potenza
 Pouissance
 Bestuekung
 Potencia
6 W

Series wiring

Cablaggio in serie
 Câblage en série
 Verkabelung in Serie
 Cableado en serie



CCT/CRI/Flux

2700K — 540 lm
 3000K — 600 lm
 4000K — 620 lm

CRI98
 2-Step MacAdam

Photometric diagrams

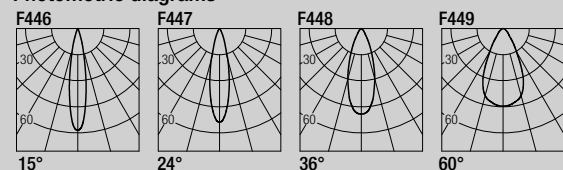

Code Construction

Costruzione del codice - Construction du code produit
 Bau der Produkt-Code - Construcción del código de producto

FX6 X X X X

Beam angle
 Apertura di fascio
 Angle de faisceau
 Strahlwinkel
 Ángulo del haz

N	S	M	W
15°	24°	36°	60°

Color Temperature
 Temperatura colore
 Température couleur
 Temperaturabhängige Farbe
 Temperatura de color

2	3	4
2700K	3000K	4000K

Finishing
 Finitura
 Finitions
 Oberflächenfinish
 Acabados

1	5
White Bianco Blanc Weiß Blanco	Black Nero Noir Schwarz Negro

Shape
 Forma
 Forme
 Form

1	2
Round Tondo Ronde Runde Redondo	Square Quadro Carré Quadrat Cuadrado

Drivers

Alimentatori - Alimentateurs
 Netzteile - Alimentadores

on/off	dimmmable
500 mA	
AL1074 (1..2) 30mm IP20	AL4010 (1..4) 72mm IP20 PUSH 0/1..10V
AL1077 (1..2) 40mm IP20	AL4151 (1..4) 72mm IP20 DALI 2
AL1084 (1..3) 55mm IP20 S.P.	AL4153 (1..4) 56mm IP20 PUSH IGBT-TRIAC

Accessories

Accessori - Accessoires
 Zubehör - Accesorios

CSFB01

Recessing box
 Controcassa
 Boîtier d'encastrement
 Eingießgehäuse
 Caja de empotrar

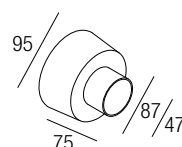

LFX601

Low luminance louver
 Filtro antiabbagliamento
 Filtre basse luminance
 Geringe Leuchtdichte-Filter
 Filtro de baja luminancia



SFX601

Milky screen
 Schermo opale
 Ecran opale
 Opal-Bildschirm
 Pantalla opal



Note: the filter and the screen must be ordered together with the lighting fixture - **Nota:** il filtro e lo schermo devono essere ordinati congiuntamente all'apparecchio - **Note:** le filtre et l'écran doivent être commandées en même temps que l'appareil
Anmerkung: müssen der Filter und der Bildschirm zusammen mit Leuchtkörper bestellt werden
Nota: el filtro y la pantalla deben pedirse juntos con la luminaria

AL7022

24VDC/500mA constant current converter
 Convertitore 24VDC/500mA corrente costante
 Convertisseur 24VDC/500mA courant constant
 24VDC/500mA konstanter Strom konverter
 Convertidor 24VDC/500mA corriente constante



FLEXUS 10

design: Rod&Todd

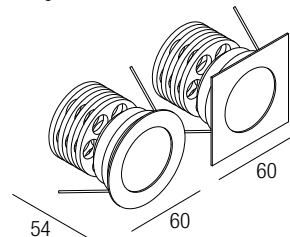

Supply current

Alimentazione
Courant d'alimentation
Stromversorgung
Corriente de alimentación
500 mA (V_I 18V)

Power

Potenza
Puissance
Bestuekung
Potencia
10 W

Series wiring

Cablaggio in serie
Câblage en série
Verkabelung in Serie
Cableado en serie



Photometric diagrams

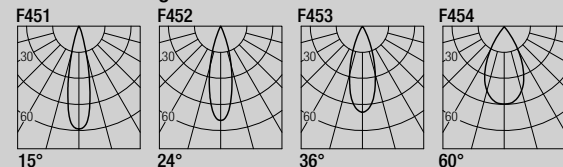

CCT/CRI/Flux

	CRI85	CRI93
2700K	890 lm	840 lm
3000K	1000 lm	930 lm
4000K	1040 lm	960 lm

CRI85 - CRI93

2-Step MacAdam

Code Construction

Costruzione del codice - Construction du code produit
Bau der Produkt-Code - Construcción del código de producto

FX1 X X X X X

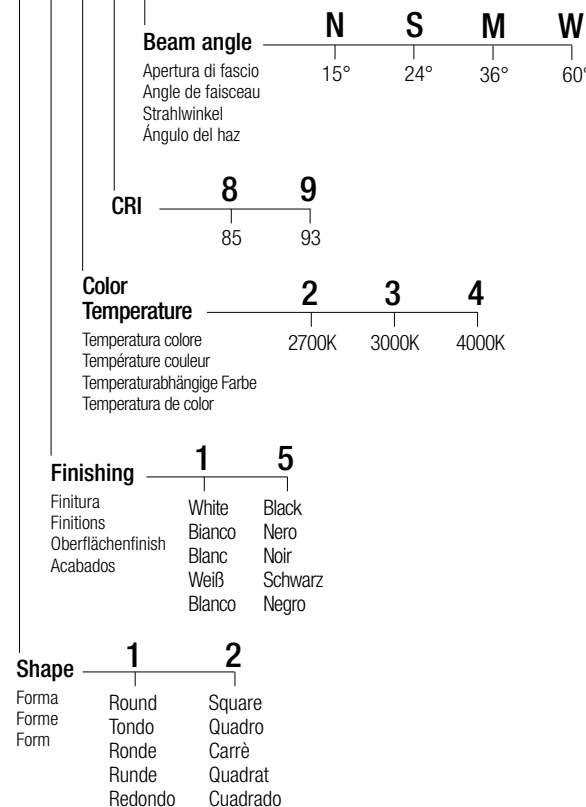

Drivers

Alimentatori - Alimentateurs
Netzteile - Alimentadores

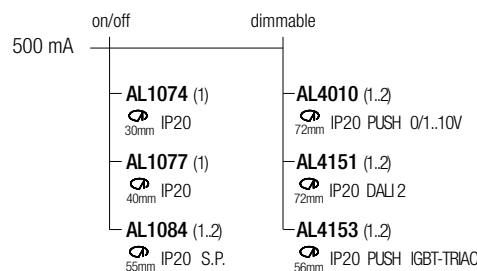

FLEXUS 724

design: Rod&Todd

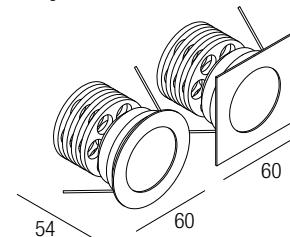

Supply current

Alimentazione
Courant d'alimentation
Stromversorgung
Corriente de alimentación
24 VDC

Power

Potenza
Puissance
Bestuekung
Potencia
7 W

Parallel wiring

Cablaggio in parallelo
Câblage en parallèle
Verkabelung in parallel
Cableado en paralelo



Photometric diagrams

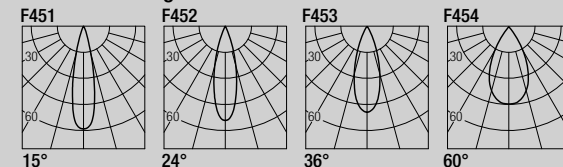

CCT/CRI/Flux

	CRI85	CRI93
2700K	630 lm	590 lm
3000K	700 lm	650 lm
4000K	730 lm	670 lm

CRI85 - CRI93

2-Step MacAdam

Code Construction

Costruzione del codice - Construction du code produit
Bau der Produkt-Code - Construcción del código de producto

FX24 X X X X X

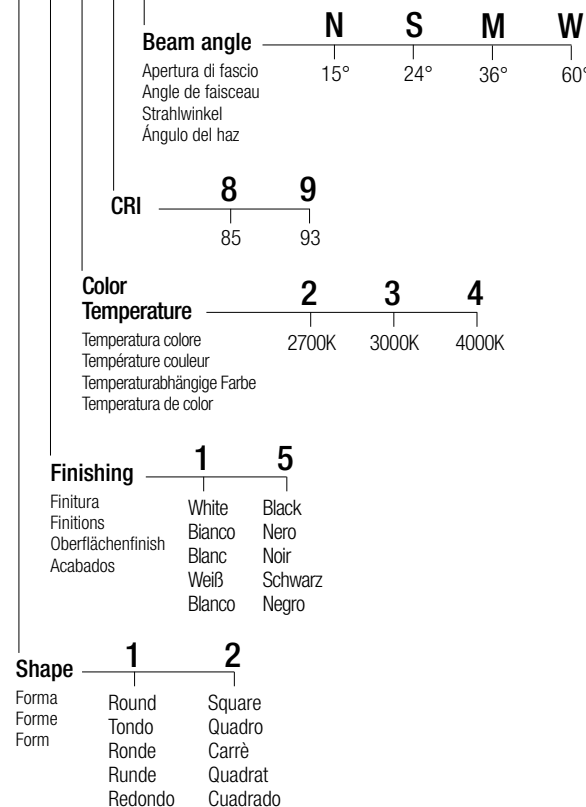

Drivers

Alimentatori - Alimentateurs
Netzteile - Alimentadores

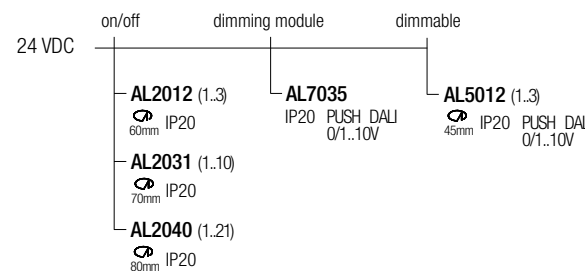

Note: dimming module AL7035 to be used in combination with an on/off 24VDC power supply
Nota: modulo di dimmerazione AL7035 da utilizzare in combinazione con un alimentatore on/off 24VDC
Note: module de variation AL7035 d'intensité à utiliser en combinaison avec une alimentation on/off 24VDC
Anmerkung: Dimmmodul AL7035 zur Verwendung in Kombination mit einem on/off 24VDC-Netzteil
Nota: módulo de regulación AL7035 se utiliza en combinación con una fuente de alimentación on/off 24VDC

Accessories

Accessori - Accessoires
Zubehör - Accesorios

CSFX01

Recessing box
Controcassa
Boîtier d'encastrement
Eingießgehäuse
Caja de empotrar

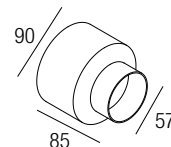

LFX101

Low luminance louver
Filtro antiabbagliamento
Filtre basse luminance
Geringe Leuchtdichte-Filter
Filtro de baja luminancia



SFX101

Milky screen
Schermo opale
Écran opale
Opal-Bildschirm
Pantalla opal



Note: the filter and the screen must be ordered together with the lighting fixture - **Nota:** il filtro e lo schermo devono essere ordinati congiuntamente all'apparecchio - **Note:** le filtre et l'écran doivent être commandées en même temps que l'appareil
Anmerkung: müssen der Filter und der Bildschirm zusammen mit Leuchtkörper bestellt werden
Nota: el filtro y la pantalla deben pedirse juntos con la luminaria

AL7022

24VDC/500mA constant current converter
Convertitore 24VDC/500mA corrente costante
Convertisseur 24VDC/500mA courant constant
24VDC/500mA konstanter Strom konverter
Convertidor 24VDC/500mA corriente constante

Accessories

Accessori - Accessoires
Zubehör - Accesorios

CSFX01

Recessing box
Controcassa
Boîtier d'encastrement
Eingießgehäuse
Caja de empotrar

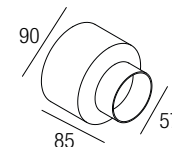

LFX2401

Low luminance louver
Filtro antiabbagliamento
Filtre basse luminance
Geringe Leuchtdichte-Filter
Filtro de baja luminancia



SFX2401

Milky screen
Schermo opale
Écran opale
Opal-Bildschirm
Pantalla opal



Note: the filter and the screen must be ordered together with the lighting fixture - **Nota:** il filtro e lo schermo devono essere ordinati congiuntamente all'apparecchio - **Note:** le filtre et l'écran doivent être commandées en même temps que l'appareil
Anmerkung: müssen der Filter und der Bildschirm zusammen mit Leuchtkörper bestellt werden
Nota: el filtro y la pantalla deben pedirse juntos con la luminaria

LEAF 6

design: Roberto Mantovani

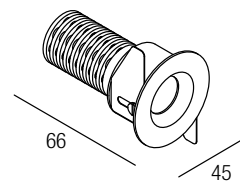

Supply current

Alimentazione
Courant d'alimentation
Stromversorgung
Corriente de alimentación

500 mA (V_i 9V)

Power

Potenza
Puissance
Bestuekung
Potencia

6 W

Series wiring

Cablaggio in serie
Câblage en série
Verkabelung in Serie
Cableado en serie



CCT/CRI/Flux

Photometric diagrams

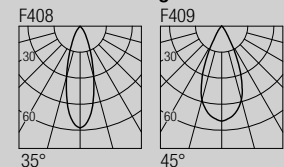

2700K — 540 lm
3000K — 600 lm
4000K — 620 lm

CRI98

2-Step MacAdam

Code Construction

Costruzione del codice - Construction du code produit
Bau der Produkt-Code - Construcción del código de producto

LF6 X X X

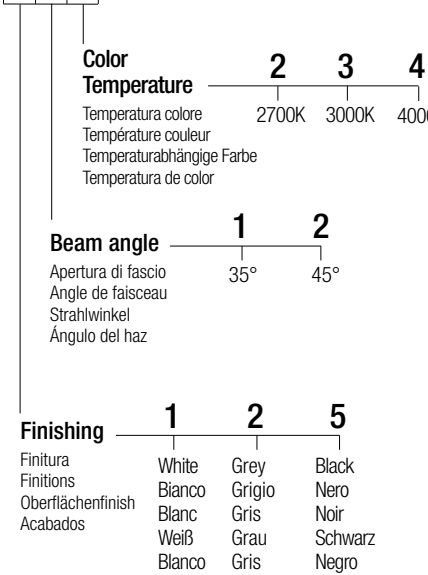

Drivers

Alimentatori - Alimentateurs
Netzteile - Alimentadores

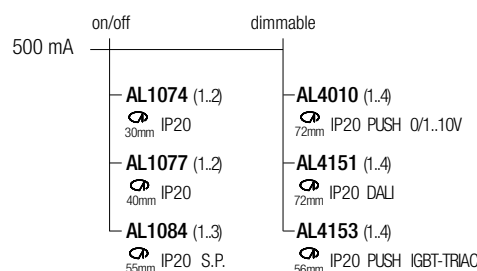

[DATASHEET](#) [INSTALLATION MANUAL](#)

[CERTIFICATIONS](#) [LDT-IES](#) [DRAWINGS](#)

LEAF 10

design: Roberto Mantovani

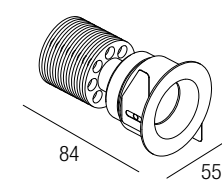

Supply current

Alimentazione
Courant d'alimentation
Stromversorgung
Corriente de alimentación

500 mA (V_i 9V)

Power

Potenza
Puissance
Bestuekung
Potencia

10 W

Series wiring

Cablaggio in serie
Câblage en série
Verkabelung in Serie
Cableado en serie



CCT/CRI/Flux

Photometric diagrams

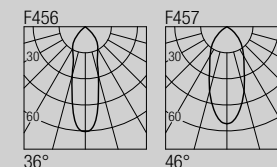

CRI85 CRI93
2700K — 890lm 840lm
3000K — 1000lm 930lm
4000K — 1040lm 960lm

CRI85-93

2-Step MacAdam

Code Construction

Costruzione del codice - Construction du code produit
Bau der Produkt-Code - Construcción del código de producto

LF1 X X X X

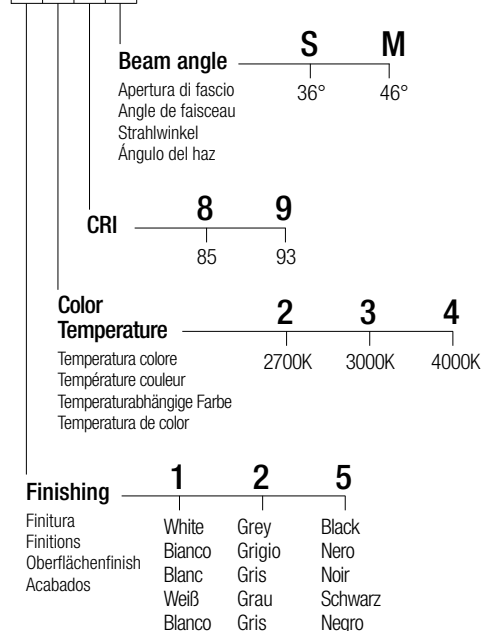

Drivers

Alimentatori - Alimentateurs
Netzteile - Alimentadores

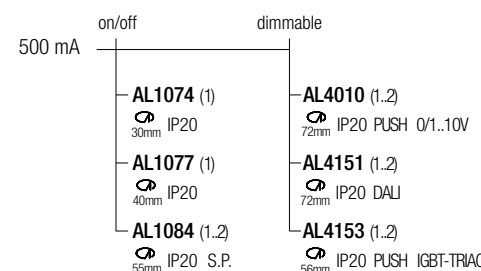

[DATASHEET](#) [INSTALLATION MANUAL](#)

[CERTIFICATIONS](#) [LDT-IES](#) [DRAWINGS](#)

Accessories

Accessori - Accessoires
Zubehör - Accesorios

LLF601

Low luminance louver
Filtro antiabbagliamento
Filtre basse luminance
Geringe Leuchtdichte-Filter
Filtro de baja luminancia

SLF601

Milky screen
Schermo opale
Écran opale
Opal-Bildschirm
Pantalla opal

Note: the filter and the screen must be ordered together with the lighting fixture - **Nota:** il filtro e lo schermo devono essere ordinati congiuntamente all'apparecchio - **Note:** le filtre et l'écran doivent être commandées en même temps que l'appareil
Anmerkung: müssen der Filter und der Bildschirm zusammen mit Leuchtkörper bestellt werden
Nota: el filtro y la pantalla deben pedirse juntos con la luminaria

AL7022

24VDC/500mA constant current converter
Convertitore 24VDC/500mA corrente costante
Convertisseur 24VDC/500mA courant constant
24VDC/500mA konstanter Strom konverter
Convertidor 24VDC/500mA corriente constante

Accessories

Accessori - Accessoires
Zubehör - Accesorios

LLF101

Low luminance louver
Filtro antiabbagliamento
Filtre basse luminance
Geringe Leuchtdichte-Filter
Filtro de baja luminancia

SLF101

Milky screen
Schermo opale
Écran opale
Opal-Bildschirm
Pantalla opal

Note: the filter and the screen must be ordered together with the lighting fixture - **Nota:** il filtro e lo schermo devono essere ordinati congiuntamente all'apparecchio - **Note:** le filtre et l'écran doivent être commandées en même temps que l'appareil
Anmerkung: müssen der Filter und der Bildschirm zusammen mit Leuchtkörper bestellt werden
Nota: el filtro y la pantalla deben pedirse juntos con la luminaria

AL7022

24VDC/500mA constant current converter
Convertitore 24VDC/500mA corrente costante
Convertisseur 24VDC/500mA courant constant
24VDC/500mA konstanter Strom konverter
Convertidor 24VDC/500mA corriente constante

WOLF

design: Roberto Mantovani

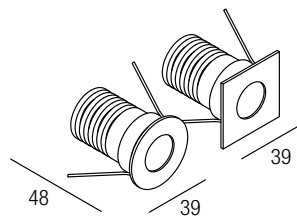

Supply current
Alimentazione
Courant d'alimentation
Stromversorgung
Corriente de alimentación
24 VDC

Power
Potenza
Puissance
Bestuekung
Potencia
2 W

Parallel wiring
Cablaggio in parallelo
Câblage en parallèle
Verkabelung in parallel
Cableado en paralelo



CCT/CRI/Flux

2700K — 128 lm
3000K — 133 lm
4200K — 154 lm

Photometric diagrams

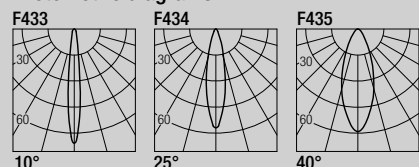

CRI85
2-Step MacAdam

Code Construction

Costruzione del codice - Construction du code produit
Bau der Produkt-Code - Construcción del código de producto

WLF X X X X

Color Temperature 0 1 2
Temperatura colore 2700K 3000K 4200K
Température couleur
Temperaturabhängige Farbe
Temperatura de color

Beam angle 0 1 2
Apertura di fascio 10° 25° 40°
Angle de faisceau
Strahlwinkel
Ángulo del haz

Finishing 1 2 3 4 5 6 7
Finitura
Finitions
Oberflächenfinish
Acabados

1	2	3	4	5	6	7
White Bianco Blanc Weiß Blanco	Aluminium Alluminio Aluminium Aluminio	Chrome Cromo Chrom	Gold Oro Or	Black Nero Noir Schwarz Negro	Bronze Bronzo Bronce	Titanium Titanio Titane Titan

Shape 1 2
Forma
Forme
Form

1	2
Round Tondo Ronde Runde Redondo	Square Quadro Carré Quadrat Cuadrado

Accessories

Accessori - Accessoires
Zubehör - Accesorios

LWLF01

Low luminance louver
Filtro antiabbagliamento
Filtre basse luminance
Geringe Leuchtdichte-Filter
Filtro de baja luminancia

Note: the filter must be ordered together with the lighting fixture - **Nota:** il filtro deve essere ordinato congiuntamente all'apparecchio - **Note:** le filtre doit être commandé en même temps que l'appareil - **Anmerkung:** muss der Filter zusammen mit Leuchtkörper bestellt werden
Nota: el filtro debe pedirse junto con la luminaria

Drivers

Alimentatori - Alimentateurs
Netzteile - Alimentadores

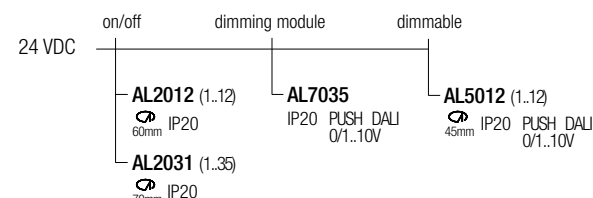

Note: dimming module AL7035 to be used in combination with an on/off 24VDC power supply
Nota: modulo di dimmerazione AL7035 da utilizzare in combinazione con un alimentatore on/off 24VDC
Note: module de variation AL7035 d'intensité à utiliser en combinaison avec une alimentation on/off 24VDC
Anmerkung: Dimmmodul AL7035 zur Verwendung in Kombination mit einem on/off 24VDC-Netzteil
Nota: módulo de regulación AL7035 se utiliza en combinación con una fuente de alimentación on/off 24VDC



TAG

design: Roberto Mantovani

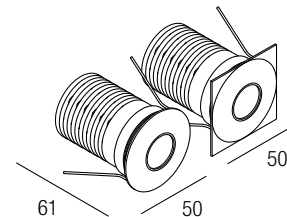

Supply current

Alimentazione
Courant d'alimentation
Stromversorgung
Corriente de alimentación
24 VDC

Power

Potenza
Puissance
Bestuekung
Potencia
7 W

Parallel wiring

Cablaggio in parallelo
Câblage en parallèle
Verkabelung in parallel
Cableado en paralelo



CCT/CRI/Flux

	CRI85	CRI93
2700K	630 lm	590 lm
3000K	700 lm	650 lm
4000K	730 lm	670 lm

Photometric diagrams

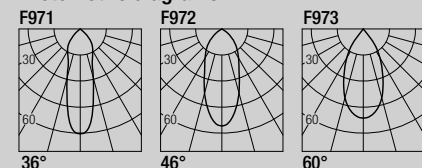

CRI85 - CRI93

2-Step MacAdam

Code Construction

Costruzione del codice - Construction du code produit
Bau der Produkt-Code - Construcción del código de producto

TA X X X X X

Beam angle S M W
Apertura di fascio 36° 46° 60°
Angle de faisceau
Strahlwinkel
Ángulo del haz

CRI 8 9
85 93

Color Temperature 2 3 4
Temperatura colore 2700K 3000K 4000K
Température couleur
Temperaturabhängige Farbe
Temperatura de color

Finishing 1 2 5
Finitura White Grey Black
Finitions Bianco Grigio Nero
Oberflächenfinish Blanc Gris Noir
Acabados Weiß Grau Schwarz
Blanco Negro

Shape 1 2
Forma Round Square
Forme Tondo Quadro
Forme Ronde Carré
Runde Quadrat
Redondo Cuadrado

Drivers

Alimentatori - Alimentateurs
Netzteile - Alimentadores

24 VDC	on/off	dimming module	dimmable
AL2012 (1..3)	AL7035	AL5012 (1..3)	
60mm IP20	IP20 PUSH DALI 0/1..10V	45mm IP20 PUSH DALI 0/1..10V	
AL2031 (1..10)			
70mm IP20			
AL2040 (1..21)			
80mm IP20			

Note: dimming module AL7035 to be used in combination with an on/off 24VDC power supply
Nota: modulo di dimmerazione AL7035 da utilizzare in combinazione con un alimentatore on/off 24VDC
Note: module de variation AL7035 d'intensité à utiliser en combinaison avec une alimentation on/off 24VDC
Anmerkung: Dimmmodul AL7035 zur Verwendung in Kombination mit einem on/off 24VDC-Netzteil
Nota: módulo de regulación AL7035 se utiliza en combinación con una fuente de alimentación on/off 24VDC



HERO 2

design: Lapo Grassellini

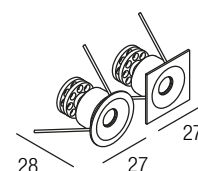

Supply current

Alimentazione
 Courant d'alimentation
 Stromversorgung
 Corriente de alimentación
350-500 mA (V_i 2,9V)

Power

Potenza
 Pouissance
 Bestuekung
 Potencia
1-2 W

Series wiring

Cablaggio in serie
 Câblage en série
 Verkabelung in Serie
 Cableado en serie



Photometric diagrams

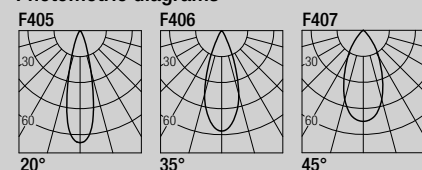

CCT/CRI/Flux

	350mA	500mA
2700K	89 lm	128 lm
3000K	93 lm	133 lm
4200K	103 lm	154 lm

CRI85

2-Step MacAdam

Code Construction

Costruzione del codice - Construction du code produit
 Bau der Produkt-Code - Construcción del código de producto

HR2 X X X X

Beam angle	S	M	W
Apertura di fascio Angle de faisceau Strahlwinkel Ángulo del haz	20°	35°	45°

Color Temperature	2	3	4
Temperatura colore Température couleur Temperaturabhängige Farbe Temperatura de color	2700K	3000K	4200K

Finishing	1	2	5
Finitura Finitions Oberflächenfinish Acabados	White Bianco Blanc Weiß Blanco	Grey Grigio Gris Grau	Black Nero Noir Schwarz Negro

Shape	1	2
Forma Forme Form	Round Tondo Ronde Runde Redondo	Square Quadro Carré Quadrat Cuadrado

Accessories

Accessori - Accessoires
 Zubehör - Accesorios

AL7022

24VDC/500mA constant current converter
 Convertitore 24VDC/500mA corrente costante
 Convertisseur 24VDC/500mA courant constant
 24VDC/500mA konstanter Strom konverter
 Convertidor 24VDC/500mA corriente constante

Drivers

Alimentatori - Alimentateurs
 Netzteile - Alimentadores

Current	on/off	dimnable	
350 mA	AL1034 (1.11) 30mm IP20	AL4000 (1.12) 72mm IP20 PUSH 0/1..10V	
	AL1035 (1.11) 40mm IP20	AL4051 (2.14) 72mm IP20 DALI 2	
	AL1037 (1.16) 55mm IP20 S.P.	AL4053 (1.14) 56mm IP20 PUSH IGBT-TRIAC	
	500 mA	AL1074 (1.7) 30mm IP20	AL4010 (1.12) 72mm IP20 PUSH 0/1..10V
		AL1077 (1.6) 40mm IP20	AL4151 (2.14) 72mm IP20 DALI 2
		AL1084 (1.11) 55mm IP20 S.P.	AL4153 (1.14) 56mm IP20 PUSH IGBT-TRIAC



HERO 6

design: Lapo Grassellini

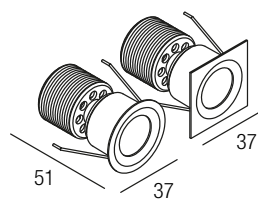

Supply current

Alimentazione
 Courant d'alimentation
 Stromversorgung
 Corriente de alimentación

500 mA (V, 9V)

Power

Potenza
 Pouissance
 Bestuekung
 Potencia

6 W

Series wiring

Cablaggio in serie
 Câblage en série
 Verkabelung in Serie
 Cableado en serie



CCT/CRI/Flux

Photometric diagrams

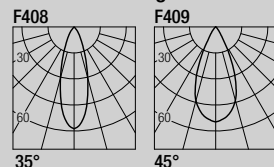

2700K — 540 lm
 3000K — 600 lm
 4000K — 620 lm

CRI98

2-Step MacAdam

Code Construction

Costruzione del codice - Construction du code produit
 Bau der Produkt-Code - Construcción del código de producto

HR6 X X X X

Beam angle — S M
 Apertura di fascio 35° 45°
 Angle de faisceau
 Strahlwinkel
 Ángulo del haz

Color Temperature — 2 3 4
 Temperatura colore 2700K 3000K 4000K
 Température couleur
 Temperaturabhängige Farbe
 Temperatura de color

Finishing — 1 2 5
 Finitura White Grey Black
 Finitions Bianco Grigio Nero
 Oberflächenfinish Blanc Gris Noir
 Acabados Weiß Grau Schwarz
 Blanco Negro

Shape — 1 2
 Forma Round Square
 Forme Tondo Quadro
 Form Ronde Carré
 Runde Quadrat
 Redondo Cuadrado

Accessories

Accessori - Accessoires
 Zubehör - Accesorios

SHR601

Milky screen
 Schermo opale
 Écran opale
 Opal-Bildschirm
 Pantalla opal

Note: the screen must be ordered together with the lighting fixture - **Nota:** lo schermo deve essere ordinato congiuntamente all'apparecchio - **Note:** l'écran doit être commandé en même temps que l'appareil
Anmerkung: muss der Bildschirm zusammen mit Leuchtkörper bestellt werden - **Nota:** la pantalla debe pedirse junta con la luminaria

AL7022

24VDC/500mA constant current converter
 Convertitore 24VDC/500mA corrente costante
 Convertisseur 24VDC/500mA courant constant
 24VDC/500mA konstanter Strom converter
 Convertidor 24VDC/500mA corriente constante

Drivers

Alimentatori - Alimentateurs
 Netzteile - Alimentadores

500 mA	on/off	dimmable
AL1074 (1..2)	30mm IP20	AL4010 (1..4)
AL1077 (1..2)	40mm IP20	AL4151 (1..4)
AL1084 (1..3)	55mm IP20 S.P.	AL4153 (1..4)
		72mm IP20 PUSH 0/1..10V
		72mm IP20 DALI 2
		56mm IP20 PUSH IGBT-TRIAC

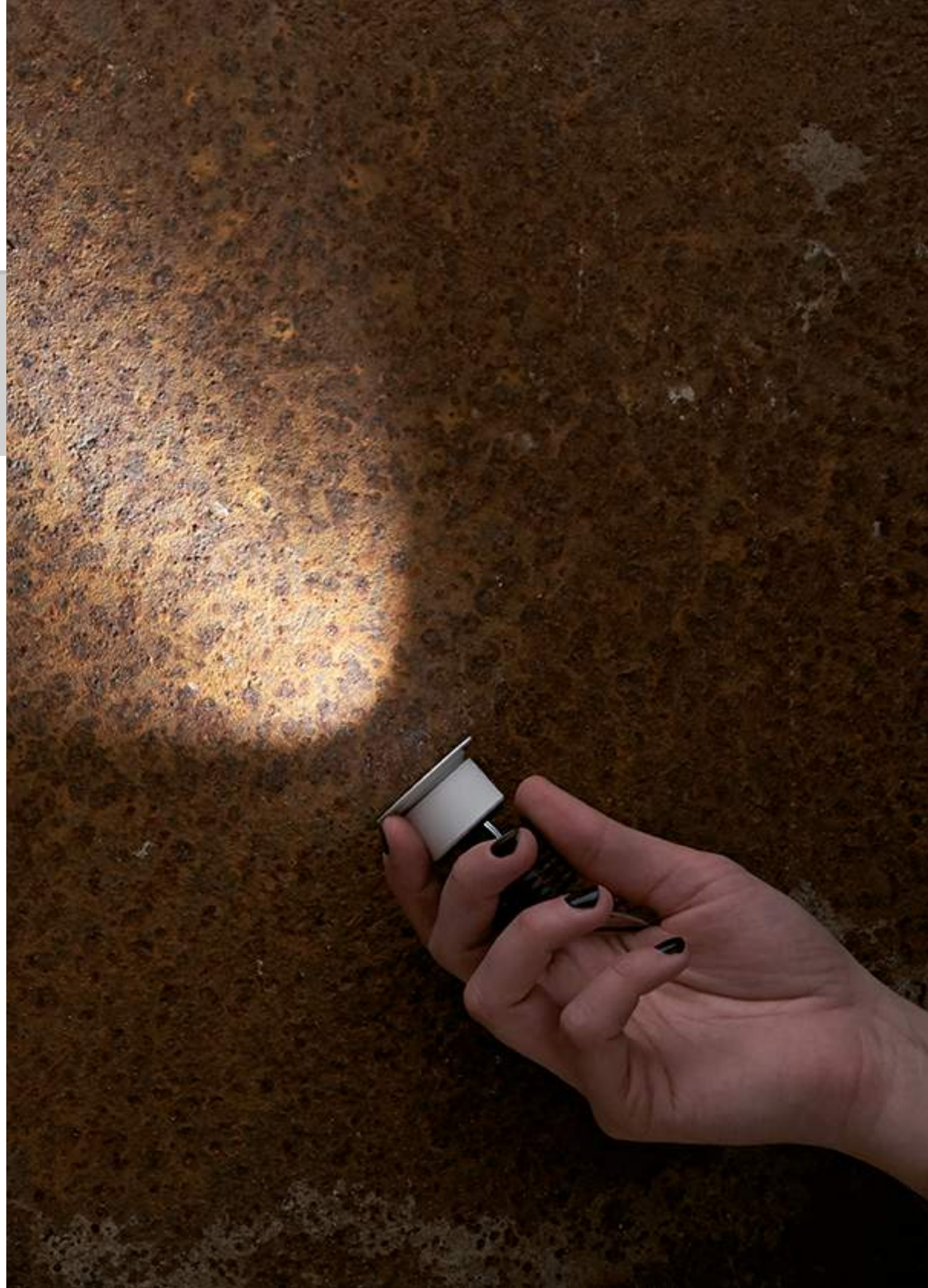

HERO 10

design: Lapo Grassellini

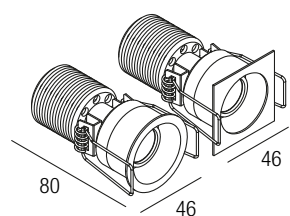

Supply current
 Alimentazione
 Courant d'alimentation
 Stromversorgung
 Corriente de alimentación
250 mA (V, 36V)

Power
 Potenza
 Pouissance
 Bestuekung
 Potencia
10 W



CCT/CRI/Flux

	CRI85	CRI93
2700K	890 lm	840 lm
3000K	1000 lm	930 lm
4000K	1040 lm	960 lm

CRI85 - CRI93

2-Step MacAdam

Photometric diagrams

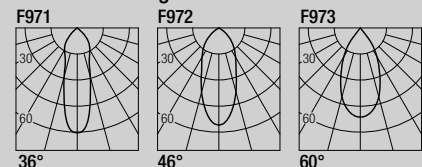

Code Construction

Costruzione del codice - Construction du code produit
 Bau der Produkt-Code - Construcción del código de producto

H1 X X X X X

Beam angle
 Apertura di fascio
 Angle de faisceau
 Strahlwinkel
 Ángulo del haz

	S	M	W
	36°	46°	60°

CRI

	8	9
	85	93

Color Temperature
 Temperatura colore
 Température couleur
 Temperaturabhängige Farbe
 Temperatura de color

	2	3	4
	2700K	3000K	4000K

Finishing

	1	2	5
Finitura	White	Grey	Black
Finitions	Bianco	Grigio	Nero
Oberflächenfinish	Blanc	Gris	Noir
Acabados	Weiß	Grau	Schwarz
	Bianco		Negro

Shape

	1	2
Forma	Round	Square
Forme	Tondo	Quadro
Form	Ronde	Carrè
	Runde	Quadrat
	Redondo	Cuadrado

Accessories

Accessori - Accessoires
 Zubehör - Accesorios

LOH1 LOH1B LOH1G
 White Black Grey
 Bianco Nero Grigio
 Blanc Noir Gris
 Weiß Schwarz Grau
 Blanco Negro

Low luminance louver
 Filtro antiabbagliamento
 Filtre basse luminance
 Geringe Leuchtdichte-Filter
 Filtro de baja luminancia

SH101

Milky screen
 Schermo opale
 Écran opale
 Opal-Bildschirm
 Pantalla opal

Note: the screen must be ordered together with the lighting fixture - **Nota:** lo schermo deve essere ordinato congiuntamente all'apparecchio - **Note:** l'écran doit être commandé en même temps que l'appareil

Anmerkung: muss der Bildschirm zusammen mit Leuchtörper bestellt werden - **Nota:** la pantalla debe pedirse junta con la luminaria

Drivers

Alimentatori - Alimentateurs
 Netzteile - Alimentadores

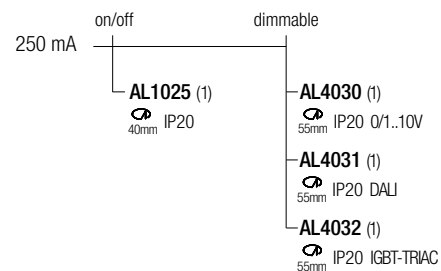

HERO 20

design: Lapo Grassellini

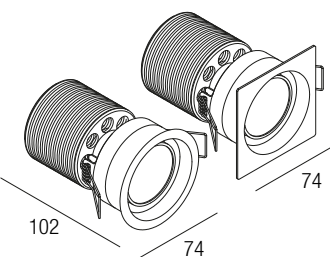

Supply current
 Alimentazione
 Courant d'alimentation
 Stromversorgung
 Corriente de alimentación
500 mA (V, 36V)

Power
 Potenza
 Pouissance
 Bestuekung
 Potencia
20 W



CCT/CRI/Flux

CCT	CRI85	CRI93
2700K	1830 lm	1700 lm
3000K	2000 lm	1830 lm
4000K	2100 lm	1950 lm

Photometric diagrams

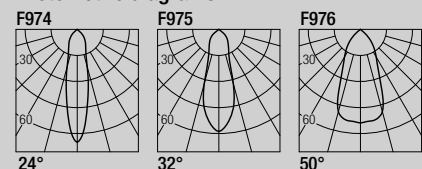

CRI85 - CRI93
2-Step MacAdam

Code Construction

Costruzione del codice - Construction du code produit
 Bau der Produkt-Code - Construcción del código de producto

H2 X X X X X

Beam angle
 Apertura di fascio
 Angle de faisceau
 Strahlwinkel
 Ángulo del haz

S	M	W
24°	32°	50°

CRI

8	9
85	93

Color Temperature
 Temperatura colore
 Température couleur
 Temperaturabhängige Farbe
 Temperatura de color

2	3	4
2700K	3000K	4000K

Finishing

1	2	5
White	Grey	Black
Bianco	Grigio	Nero
Blanc	Gris	Noir
Weiß	Grau	Schwarz
Blanco		Negro

Shape

1	2
Round	Square
Tondo	Quadro
Ronde	Carré
Runde	Quadrat
Redondo	Cuadrado

Accessories

Accessori - Accessoires
 Zubehör - Accesorios

LOH2 LOH2B LOH2G

White	Black	Grey
Bianco	Nero	Grigio
Blanc	Noir	Gris
Weiß	Schwarz	Grau
Blanco	Negro	

Low luminance louver
 Filtro antiabbagliamento
 Filtre basse luminance
 Geringe Leuchtdichte-Filter
 Filtro de baja luminancia

SH201

Milky screen
 Schermo opale
 Ecran opale
 Opal-Bildschirm
 Pantalla opal

Note: the screen must be ordered together with the lighting fixture - **Nota:** lo schermo deve essere ordinato congiuntamente all'apparecchio - **Note:** l'écran doit être commandé en même temps que l'appareil
Anmerkung: muss der Bildschirm zusammen mit Leuchtkörper bestellt werden - **Nota:** la pantalla debe pedirse junta con la luminaria

Drivers

Alimentatori - Alimentateurs
 Netzteile - Alimentadores

500 mA	on/off	dimmable
AL1084 (1)	55mm	IP20 S.P.
AL4010 (1)	72mm	IP20 PUSH 0/1..10V
AL4151 (1)	72mm	IP20 DALI2
AL4153 (1)	56mm	IP20 PUSH IGBT-TRIAC



JUNO 10

design: Lapo Grassellini

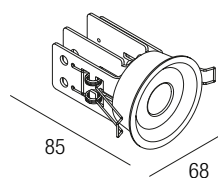

Supply current

Alimentazione
Courant d'alimentation
Stromversorgung
Corriente de alimentación

250 mA (V_i 36V)

Power

Potenza
Puissance
Bestuekung
Potencia

10 W



CCT/CRI/Flux

	CRI85	CRI93
2700K	890 lm	840 lm
3000K	1000 lm	930 lm
4000K	1040 lm	960 lm

Photometric diagrams

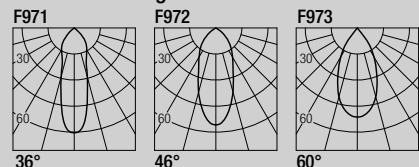

CRI85 - CRI93

2-Step MacAdam

Code Construction

Costruzione del codice - Construction du code produit
Bau der Produkt-Code - Construcción del código de producto

JU1 X X X X

Beam angle

Apertura di fascio
Angle de faisceau
Strahlwinkel
Ángulo del haz

S	M	W
36°	46°	60°

CRI

8	9
85	93

Color Temperature

Temperatura colore
Température couleur
Temperaturabhängige Farbe
Temperatura de color

2	3	4
2700K	3000K	4000K

Finishing

1	2	5
White	Grey	Black
Bianco	Grigio	Nero
Blanc	Gris	Noir
Weiß	Grau	Schwarz
Blanco		Negro

Accessories

Accessori - Accessoires
Zubehör - Accesorios

SJU101

Milky screen
Schermo opale
Écran opale
Opal-Bildschirm
Pantalla opal

Note: the screen must be ordered together with the lighting fixture - **Nota:** lo schermo deve essere ordinato congiuntamente all'apparecchio - **Note:** l'écran doit être commandé en même temps que l'appareil
Anmerkung: muss der Bildschirm zusammen mit Leuchtkörper bestellt werden - **Nota:** la pantalla debe pedirse junta con la luminaria

Drivers

Alimentatori - Alimentateurs
Netzteile - Alimentadores

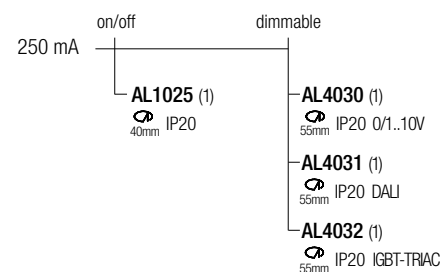

JUNO 20

design: Lapo Grassellini

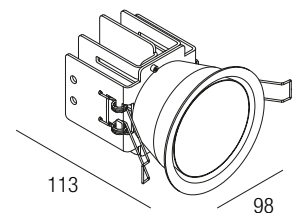

Supply current
 Alimentazione
 Courant d'alimentation
 Stromversorgung
 Corriente de alimentación
500 mA (V, 36V)

Power
 Potenza
 Pouissance
 Bestuekung
 Potencia
20 W



Photometric diagrams

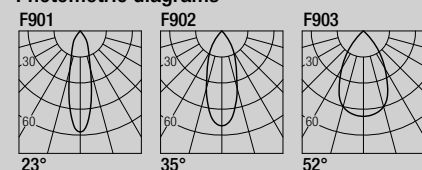

CCT/CRI/Flux	CRI85	CRI93
2700K	1830 lm	1700 lm
3000K	2000 lm	1830 lm
4000K	2100 lm	1950 lm

CRI85 - CRI93
2-Step MacAdam

Code Construction

Costruzione del codice - Construction du code produit
 Bau der Produkt-Code - Construcción del código de producto

JU2 X X X X

Beam angle Apertura di fascio Angle de faisceau Strahlwinkel Ángulo del haz	S	M	W
	23°	35°	52°
CRI	8	9	
	85	93	
Color Temperature Temperatura colore Température couleur Temperaturabhängige Farbe Temperatura de color	2	3	4
	2700K	3000K	4000K
Finishing Finitura Finitions Oberflächenfinish Acabados	1	2	5
	White Bianco Blanc Weiß Blanco	Grey Grigio Gris Grau	Black Nero Noir Schwarz Negro

Drivers

Alimentatori - Alimentateurs
 Netzteile - Alimentadores

500 mA	on/off	dimmable
AL1084 (1)	56mm IP20 S.P.	
AL4010 (1)	72mm IP20 PUSH 0/1..10V	
AL4151 (1)	72mm IP20 DALI 2	
AL4153 (1)	56mm IP20 PUSH IGBT-TRIAC	



LOREN 10

design: Lapo Grassellini

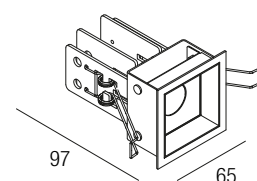

Supply current

Alimentazione
 Courant d'alimentation
 Stromversorgung
 Corriente de alimentación
250 mA (V_i 36V)

Power

Potenza
 Pouissance
 Bestuekung
 Potencia
10 W



CCT/CRI/Flux

	CRI85	CRI93
2700K	890 lm	840 lm
3000K	1000 lm	930 lm
4000K	1040 lm	960 lm

Photometric diagrams

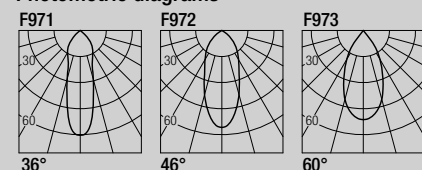

CRI85 - CRI93

2-Step MacAdam

Code Construction

Costruzione del codice - Construction du code produit
 Bau der Produkt-Code - Construcción del código de producto

LR1 X X X X

Beam angle

Apertura di fascio
 Angle de faisceau
 Strahlwinkel
 Ángulo del haz

S	M	W
36°	46°	60°

CRI

8	9
85	93

Color Temperature

Temperatura colore
 Température couleur
 Temperaturabhängige Farbe
 Temperatura de color

2	3	4
2700K	3000K	4000K

Finishing

1	2	5
White Bianco Blanc Weiß Blanco	Grey Grigio Gris Grau	Black Nero Noir Schwarz Negro

Accessories

Accessori - Accessoires
 Zubehör - Accesorios

SLR101

Milky screen
 Schermo opale
 Écran opale
 Opal-Bildschirm
 Pantalla opal

Note: the screen must be ordered together with the lighting fixture - **Nota:** lo schermo deve essere ordinato congiuntamente all'apparecchio - **Note:** l'écran doit être commandé en même temps que l'appareil
Anmerkung: muss der Bildschirm zusammen mit Leuchtkörper bestellt werden - **Nota:** la pantalla debe pedirse junta con la luminaria

Drivers

Alimentatori - Alimentateurs
 Netzteile - Alimentadores

250 mA	on/off	dimmable
AL1025 (1)	40mm IP20	
		AL4030 (1)
		55mm IP20 0/1..10V
		AL4031 (1)
		55mm IP20 DALI
		AL4032 (1)
		55mm IP20 IGBT-TRIAC



LOREN 20

design: Lapo Grassellini

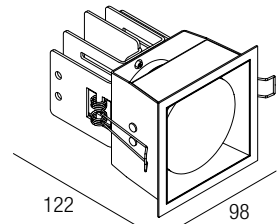

Supply current
 Alimentazione
 Courant d'alimentation
 Stromversorgung
 Corriente de alimentación
500 mA (V_i 36V)

Power
 Potenza
 Pouissance
 Bestuekung
 Potencia
20 W

[DATASHEET ▶](#) [INSTALLATION MANUAL ▶](#)
[CERTIFICATIONS ▶](#) [LDT-IES ▶](#) [DRAWINGS ▶](#)



90x90 mm IP20

Photometric diagrams

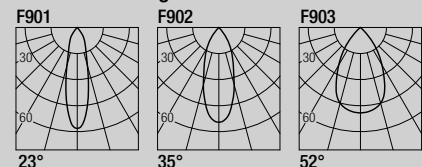

CCT/CRI/Flux	CRI85	CRI93
2700K	1830 lm	1700 lm
3000K	2000 lm	1830 lm
4000K	2100 lm	1950 lm

CRI85 - CRI93
 2-Step MacAdam

Code Construction

Costruzione del codice - Construction du code produit
 Bau der Produkt-Code - Construcción del código de producto

LR2 X X X X

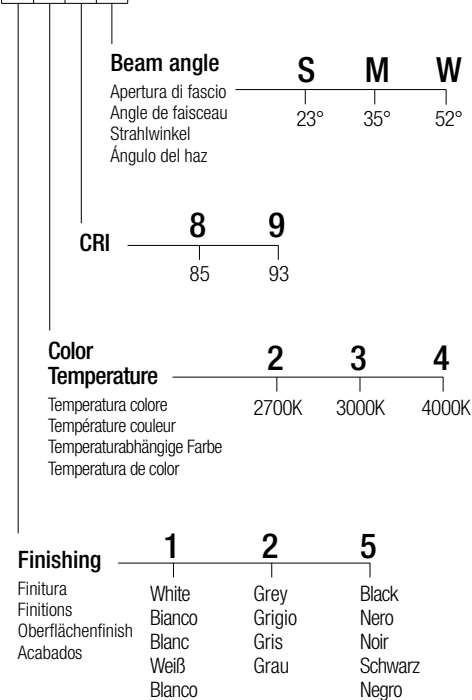

Drivers

Alimentatori - Alimentateurs
 Netzteile - Alimentadores

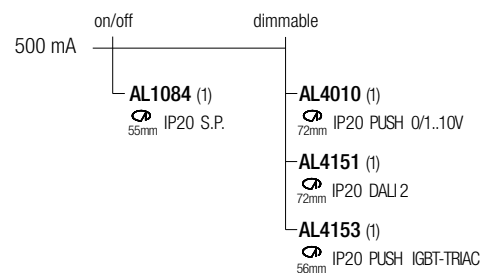

KURT R10

design: Lapo Grassellini

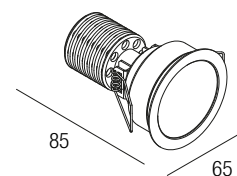

Supply current

Alimentazione
 Courant d'alimentation
 Stromversorgung
 Corriente de alimentación
250 mA (V, 36V)

Power

Potenza
 Pouissance
 Bestuekung
 Potencia
10 W



Photometric diagrams

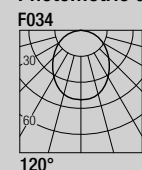

CCT/CRI/Flux

	CRI85	CRI93
2700K	630 lm	590 lm
3000K	700 lm	650 lm
4000K	730 lm	670 lm

CRI85 - CRI93

2-Step MacAdam

Code Construction

Costruzione del codice - Construction du code produit
 Bau der Produkt-Code - Construcción del código de producto

KUR1 X,X,X

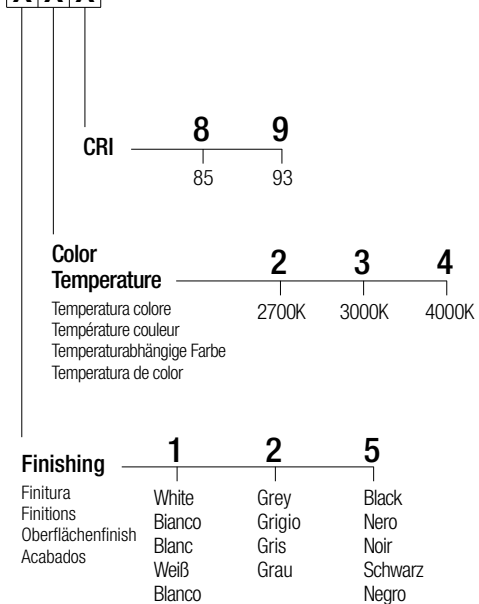

Drivers

Alimentatori - Alimentateurs
 Netzteile - Alimentadores

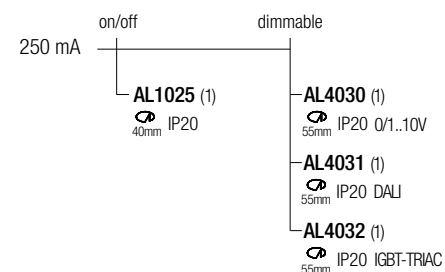

KURT Q10

design: Lapo Grassellini

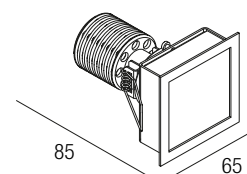

Supply current

Alimentazione
 Courant d'alimentation
 Stromversorgung
 Corriente de alimentación
250 mA (V, 36V)

Power

Potenza
 Pouissance
 Bestuekung
 Potencia
10 W



Photometric diagrams

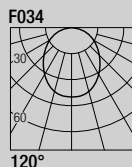

CCT/CRI/Flux

	CRI85	CRI93
2700K	630 lm	590 lm
3000K	700 lm	650 lm
4000K	730 lm	670 lm

CRI85 - CRI93

2-Step MacAdam

Code Construction

Costruzione del codice - Construction du code produit
 Bau der Produkt-Code - Construcción del código de producto

KUQ1 X,X,X

Code	Value	Meaning
CRI	8 9	85 93
Color Temperature	2 3 4	2700K 3000K 4000K
Finishing	1 2 5	White/Grigio/Black, Bianco/Grigio/Nero, Blanc/Gris/Noir, Weiß/Grau/Schwarz, Blanco/Negro

Drivers

Alimentatori - Alimentateurs
 Netzteile - Alimentadores

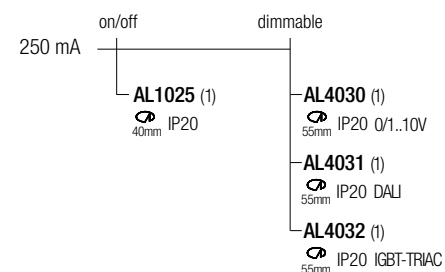

NAP 10

design: Lapo Grassellini

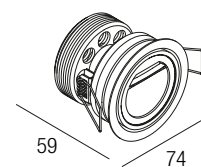

Supply current

Alimentazione
Courant d'alimentation
Stromversorgung
Corriente de alimentación

250 mA (V_I 36V)

Power

Potenza
Puissance
Bestuekung
Potencia

10 W



Photometric diagrams

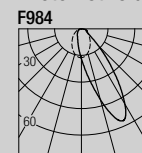

WALL WASHER

CCT/CRI/Flux

	CRI85	CRI93
2700K	890 lm	840 lm
3000K	1000 lm	930 lm
4000K	1040 lm	960 lm

CRI85 - CRI93

2-Step MacAdam

Code Construction

Costruzione del codice - Construction du code produit
Bau der Produkt-Code - Construcción del código de producto

NA1 X X X

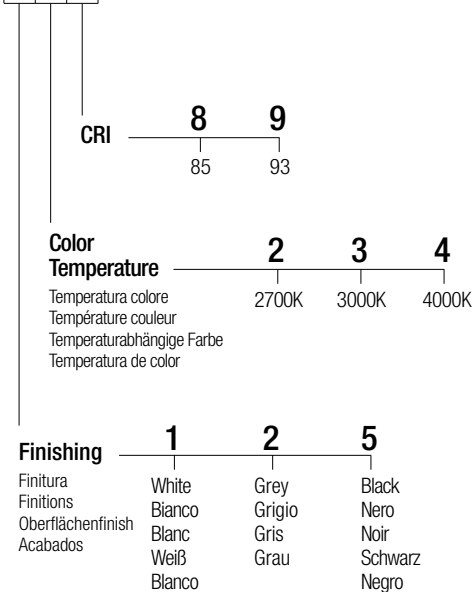

Drivers

Alimentatori - Alimentateurs
Netzteile - Alimentadores

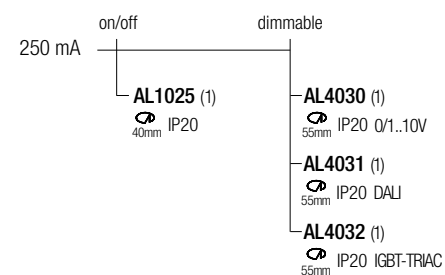

NAP 20

design: Lapo Grassellini

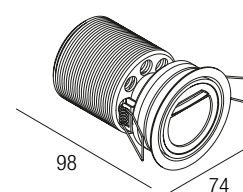

Supply current

Alimentazione
Courant d'alimentation
Stromversorgung
Corriente de alimentación

500 mA (V_f 36V)

Power

Potenza
Puissance
Bestuekung
Potencia

20 W



CCT/CRI/Flux

	CRI85	CRI93
2700K	1830 lm	1700 lm
3000K	2000 lm	1830 lm
4000K	2100 lm	1950 lm

Photometric diagrams

F984

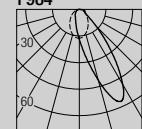

WALL WASHER

CRI85 - CRI93

2-Step MacAdam

Code Construction

Costruzione del codice - Construction du code produit
Bau der Produkt-Code - Construcción del código de producto

NA2 X X X

Code	Meaning	Options
X	CRI	8 (85), 9 (93)
X	Color Temperature	2 (2700K), 3 (3000K), 4 (4000K)
X	Finishing	1 (White/Bianco/Blanc/Weiß/Blanco), 2 (Grey/Grigio/Gris/Grau), 5 (Black/Nero/Noir/Schwarz/Negro)

Drivers

Alimentatori - Alimentateurs
Netzteile - Alimentadores

Driver	Dimensions	Protection	Control
AL1084 (1)	56mm	IP20 S.P.	on/off
AL4010 (1)	72mm	IP20 PUSH	0/1..10V dimmable
AL4151 (1)	72mm	IP20 DALI 2	dimmable
AL4153 (1)	56mm	IP20 PUSH	IGBT-TRIAC dimmable



BYE

design: Roberto Mantovani

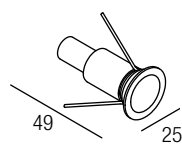

Supply current

Alimentazione
Courant d'alimentation
Stromversorgung
Corriente de alimentación
250 mA (V, 2,9V)

Power

Potenza
Puissance
Bestuekung
Potencia
0,75 W

Series wiring

Cablaggio in serie
Câblage en série
Verkabelung in Serie
Cableado en serie



CCT/CRI/Flux

2700K — 71 lm
3000K — 75 lm
4200K — 86 lm
6000K — 91 lm

CRI85

2-Step MacAdam

Photometric diagrams

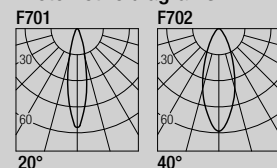

Code Construction

Costruzione del codice - Construction du code produit
Bau der Produkt-Code - Construcción del código de producto

BY1, X, X, X

Color

Temperature	0	1	2	3	6	7	8
Temperatura colore	2700K	3000K	4200K	6000K	Blue	Green	Red
Température couleur					Bleu	Vert	Rouge
Temperaturabhängige Farbe					Blau	Grün	Rot
Temperatura de color					Azul	Verde	Rojo

Beam angle

Beam angle	1	2
Apertura di fascio	20°	40°
Angle de faisceau		
Strahlwinkel		
Ángulo del haz		

Finishing

Finishing	1	2	3	4	5	6	7
Finitura	White	Aluminium	Chrome	Gold	Black	Bronze	Titanium
Finitions	Bianco	Alluminio	Chrom	Oro	Nero	Bronzo	Titane
Oberflächenfinish	Weiß	Aluminium	Chrom	Or	Schwarz	Bronce	Titan
Acabados	Blanco	Aluminio	Chrom	Or	Schwarz	Bronce	Titan

Accessories

Accessori - Accessoires
Zubehör - Accesorios

CSYY01

Recessing box
Controcassa
Boltier d'encastrement
Eingießgehäuse
Caja de empotrar

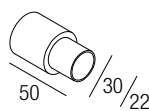

Drivers

Alimentatori - Alimentateurs
Netzteile - Alimentadores

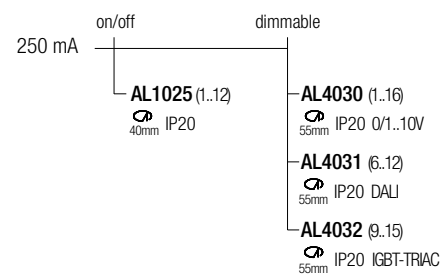

BABA R2

design: Roberto Mantovani

[DATASHEET](#) [INSTALLATION MANUAL](#)

[CERTIFICATIONS](#) [LDT-IES](#) [DRAWINGS](#)

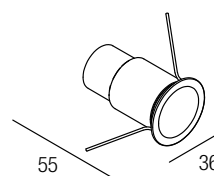

Supply current

Alimentazione
Courant d'alimentation
Stromversorgung
Corriente de alimentación
350-500 mA (V_r 2,9V)

Power

Potenza
Puissance
Bestuekung
Potencia
1-2 W

Series wiring

Cablaggio in serie
Câblage en série
Verkabelung in Serie
Cableado en serie



Photometric diagrams

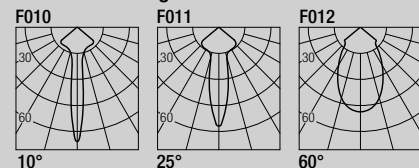

CCT/CRI/Flux

	350mA	500mA
2700K	89 lm	128 lm
3000K	93 lm	133 lm
4200K	103 lm	154 lm
6000K	114 lm	165 lm

CRI85

2-Step MacAdam

Accessories

Accessori - Accessoires
Zubehör - Accesorios

CS1006

Recessing box
Controcassa
Boîtier d'encastrement
Eingießgehäuse
Caja de empotrar

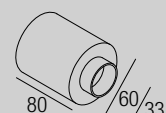

AL7022

24VDC/500mA constant current converter
Convertitore 24VDC/500mA corrente costante
Convertisseur 24VDC/500mA courant constant
24VDC/500mA konstanter Strom konverter
Convertidor 24VDC/500mA corriente constante



BABA Q2

design: Roberto Mantovani

[DATASHEET](#) [INSTALLATION MANUAL](#)

[CERTIFICATIONS](#) [LDT-IES](#) [DRAWINGS](#)

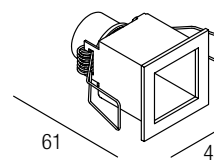

Supply current

Alimentazione
Courant d'alimentation
Stromversorgung
Corriente de alimentación
350-500 mA (V_r 2,9V)

Power

Potenza
Puissance
Bestuekung
Potencia
1-2 W

Series wiring

Cablaggio in serie
Câblage en série
Verkabelung in Serie
Cableado en serie



Photometric diagrams

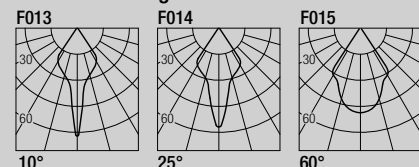

CCT/CRI/Flux

	350mA	500mA
2700K	89 lm	128 lm
3000K	93 lm	133 lm
4200K	103 lm	154 lm
6000K	114 lm	165 lm

CRI85

2-Step MacAdam

Accessories

Accessori - Accessoires
Zubehör - Accesorios

AL7022

24VDC/500mA constant current converter
Convertitore 24VDC/500mA corrente costante
Convertisseur 24VDC/500mA courant constant
24VDC/500mA konstanter Strom konverter
Convertidor 24VDC/500mA corriente constante

Code Construction

Costruzione del codice - Construction du code produit
Bau der Produkt-Code - Construcción del código de producto

BS X X X X

Color Temperature	0	1	2	3	6	7	8
Temperatura colore	2700K	3000K	4200K	6000K	Blue	Green	Red
Température couleur					Blu	Verde	Rosso
Temperaturabhängige Farbe					Bleu	Vert	Rouge
Temperatura de color					Blau	Grün	Rot
					Azul		Rojo

Beam angle	0	1	2
Apertura di fascio	10°	25°	60°
Angle de faisceau			
Strahlwinkel			
Ángulo del haz			

Finishing	1	2	5
Finitura	White	Grey	Black
Finitions	Bianco	Grigio	Nero
Oberflächenfinish	Blanc	Gris	Noir
Acabados	Weiß	Grau	Schwarz
	Blanco		Negro

Shape	1	2
Forma	Round	Square
Forme	Tondo	Quadro
Form	Ronde	Carré
	Runde	Quadrat
	Redondo	Cuadrado

Drivers

Alimentatori - Alimentateurs
Netzteile - Alimentadores

350 mA	on/off	dimmmable
AL1034 (1.11)	30mm IP20	AL4000 (1.12)
AL1035 (1.11)	40mm IP20	AL4051 (2.14)
AL1037 (1.16)	55mm IP20 S.P.	AL4053 (1.14)
		72mm IP20 PUSH 0/1..10V
		72mm IP20 DALI 2
		56mm IP20 PUSH IGBT-TRIAC
500 mA	on/off	dimmmable
AL1074 (1..7)	30mm IP20	AL4010 (1.12)
AL1077 (1..6)	40mm IP20	AL4151 (2.14)
AL1084 (1..11)	55mm IP20 S.P.	AL4153 (1.14)
		72mm IP20 PUSH 0/1..10V
		72mm IP20 DALI 2
		56mm IP20 PUSH IGBT-TRIAC

BABA R6

design: Roberto Mantovani

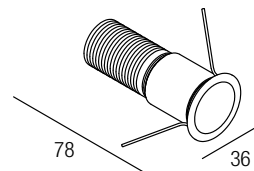

Supply current

Alimentazione
Courant d'alimentation
Stromversorgung
Corriente de alimentación

350-500 mA (V_i 8,7V)

Power

Potenza
Puissance
Bestuekung
Potencia

3-6 W

Series wiring

Cablaggio in serie
Câblage en série
Verkabelung in Serie
Cableado en serie



CCT/CRI/Flux

	350mA	500mA
2700K	267 lm	384 lm
3000K	279 lm	400 lm
4200K	309 lm	462 lm
6000K	342 lm	495 lm

CRI85

2-Step MacAdam

Photometric diagrams

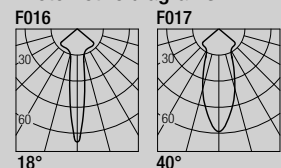

Code Construction

Costruzione del codice - Construction du code produit
Bau der Produkt-Code - Construcción del código de producto

BW1 X X X

Color

Temperature	0	1	2	3	6	7	8
Temperatura colore	2700K	3000K	4200K	6000K	Blue	Green	Red
Température couleur					Bleu	Vert	Rouge
Temperaturabhängige Farbe					Blau	Grün	Rot
Temperatura de color					Azul		Rojo

Beam angle

Apertura di fascio	1	2
Angle de faisceau	18°	40°
Strahlwinkel		
Ángulo del haz		

Finishing

Finitura	1	2	5
Finitions	White	Grey	Black
Oberflächenfinish	Bianco	Grigio	Nero
Acabados	Blanc	Gris	Noir
	Weiß	Grau	Schwarz
	Blanco		Negro

Drivers

Alimentatori - Alimentateurs
Netzteile - Alimentadores

350 mA		500 mA	
on/off	dimmable	on/off	dimmable
AL1034 (1..3) 30mm IP20	AL4000 (1..4) 72mm IP20 PUSH 0/1..10V	AL1074 (1..2) 30mm IP20	AL4010 (1..4) 72mm IP20 PUSH 0/1..10V
AL1035 (1..3) 40mm IP20	AL4051 (1..4) 72mm IP20 DALI 2	AL1077 (1..2) 40mm IP20	AL4151 (1..4) 72mm IP20 DALI 2
AL1037 (1..5) 55mm IP20 S.P.	AL4053 (1..4) 56mm IP20 PUSH IGBT-TRIAC	AL1084 (1..3) 55mm IP20 S.P.	AL4153 (1..4) 56mm IP20 PUSH IGBT-TRIAC

Accessories

Accessori - Accessoires
Zubehör - Accesorios

CS1006

Recessing box
Controcassa
Boîtier d'encastrement
Eingießgehäuse
Caja de empotrar

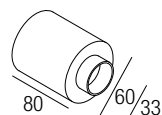

LBW101

Low luminance louver
Filtro antiabbagliamento
Filtre basse luminance
Geringe Leuchtdichte-Filter
Filtro de baja luminancia



SBW101

Milky screen
Schermo opale
Écran opale
Opal-Bildschirm
Pantalla opal



Note: the filter and the screen must be ordered together with the lighting fixture - **Nota:** il filtro e lo schermo devono essere ordinati congiuntamente all'apparecchio - **Note:** le filtre et l'écran doivent être commandées en même temps que l'appareil
Anmerkung: müssen der Filter und der Bildschirm zusammen mit Leuchtkörper bestellt werden
Nota: el filtro y la pantalla deben pedirse juntos con la luminaria

AL7022

24VDC/500mA constant current converter
Convertitore 24VDC/500mA corrente costante
Convertisseur 24VDC/500mA courant constant
24VDC/500mA konstanter Strom konverter
Convertidor 24VDC/500mA corriente constante



BABA R6 EVO

design: Roberto Mantovani

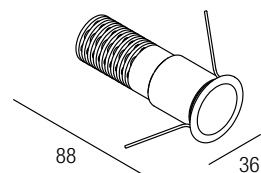

Supply current

Alimentazione
Courant d'alimentation
Stromversorgung
Corriente de alimentación

500 mA (V_i 9V)

Power

Potenza
Puissance
Bestuekung
Potencia

6 W

Series wiring

Cablaggio in serie
Câblage en série
Verkabelung in Serie
Cableado en serie



CCT/CRI/Flux

Photometric diagrams

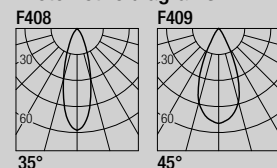

2700K — 540 lm
3000K — 600 lm
4000K — 620 lm

CRI98

2-Step MacAdam

Code Construction

Costruzione del codice - Construction du code produit
Bau der Produkt-Code - Construcción del código de producto

BWE1 X X X

Color Temperature — 2 3 4
Temperatura colore
Température couleur
Temperaturabhängige Farbe
Temperatura de color

2700K 3000K 4000K

Beam angle — 1 2
Apertura di fascio
Angle de faisceau
Strahlwinkel
Ángulo del haz

35° 45°

Finishing — 1 2 5
Finitura
Finitions
Oberflächenfinish
Acabados

1	2	5
White Bianco Blanc Weiß Blanco	Grey Grigio Gris Grau	Black Nero Noir Schwarz Negro

Drivers

Alimentatori - Alimentateurs
Netzteile - Alimentadores

on/off	dimmable
500 mA	
AL1074 (1..2) 30mm IP20	AL4010 (1..4) 72mm IP20 PUSH 0/1..10V
AL1077 (1..2) 40mm IP20	AL4151 (1..4) 72mm IP20 DALI 2
AL1084 (1..3) 55mm IP20 S.P.	AL4153 (1..4) 56mm IP20 PUSH IGBT-TRIAC

Accessories

Accessori - Accessoires
Zubehör - Accesorios

CS1006

Recessing box
Controcassa
Boîtier d'encastrement
Eingieβgehäuse
Caja de empotrar

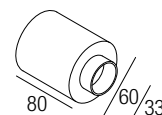

LBWE101

Low luminance louver
Filtro antiabbagliamento
Filtre basse luminance
Geringe Leuchtdichte-Filter
Filtro de baja luminancia



SBWE101

Milky screen
Schermo opale
Écran opale
Opal-Bildschirm
Pantalla opal



Note: the filter and the screen must be ordered together with the lighting fixture - **Nota:** il filtro e lo schermo devono essere ordinati congiuntamente all'apparecchio - **Note:** le filtre et l'écran doivent être commandées en même temps que l'appareil
Anmerkung: müssen der Filter und der Bildschirm zusammen mit Leuchtkörper bestellt werden
Nota: el filtro y la pantalla deben pedirse juntos con la luminaria

AL7022

24VDC/500mA constant current converter
Convertitore 24VDC/500mA corrente costante
Convertisseur 24VDC/500mA courant constant
24VDC/500mA konstanter Strom konverter
Convertidor 24VDC/500mA corriente constante

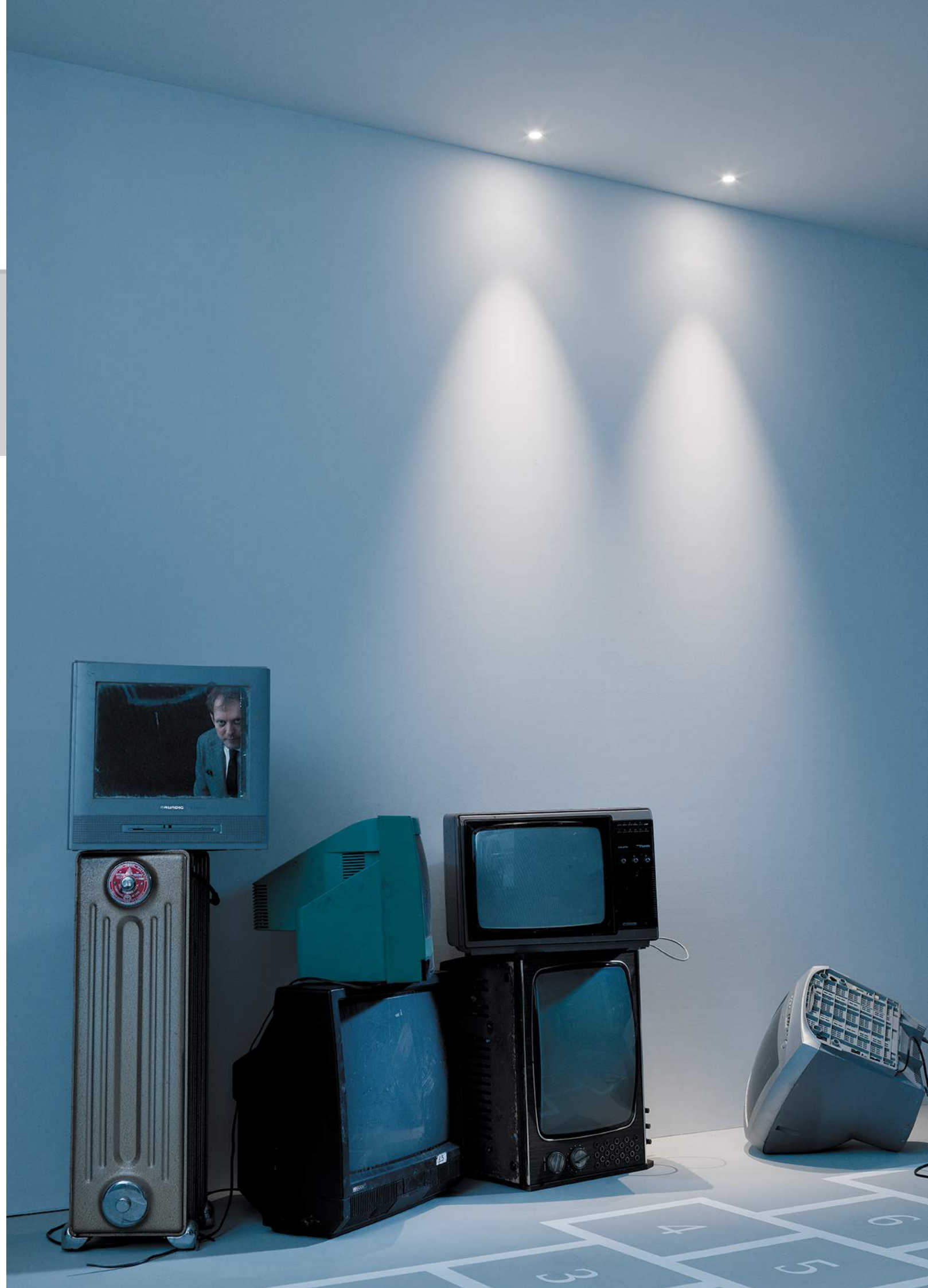

BABA Q6

design: Roberto Mantovani

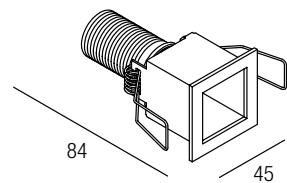

Supply current

Alimentazione
Courant d'alimentation
Stromversorgung
Corriente de alimentación

350-500 mA (V_f 8,7V)

Power

Potenza
Puissance
Bestuekung
Potencia

3-6 W

Series wiring

Cablaggio in serie
Câblage en série
Verkabelung in Serie
Cableado en serie

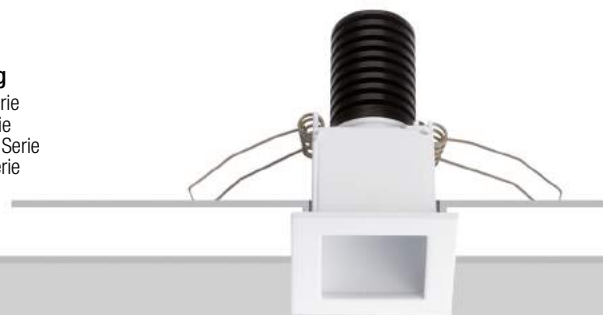

CCT/CRI/Flux

	350mA	500mA
2700K	267 lm	384 lm
3000K	279 lm	400 lm
4200K	309 lm	462 lm
6000K	342 lm	495 lm

CRI85

2-Step MacAdam

Photometric diagrams

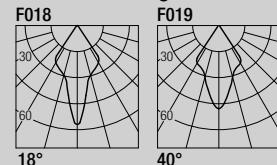

Code Construction

Costruzione del codice - Construction du code produit
Bau der Produkt-Code - Construcción del código de producto

BW2 X X X

Color Temperature	0	1	2	3	6	7	8
Temperatura colore	2700K	3000K	4200K	6000K	Blue	Green	Red
Température couleur					Bleu	Vert	Rouge
Temperaturabhängige Farbe					Blau	Grün	Rot
Temperatura de color					Azul	Rojo	

Beam angle	1	2
Apertura di fascio	18°	40°
Angle de faisceau		
Strahlwinkel		
Ángulo del haz		

Finishing	1	2	5
Finitura	White	Grey	Black
Finitions	Bianco	Grigio	Nero
Oberflächenfinish	Blanc	Gris	Noir
Acabados	Weiß	Grau	Schwarz
	Blanco		Negro

Accessories

Accessori - Accessoires
Zubehör - Accesorios

LBW201

Low luminance louver
Filtro antiabbagliamento
Filtre basse luminance
Geringe Leuchtdichte-Filter
Filtro de baja luminancia

SBW201

Milky screen
Schermo opale
Opal-Bildschirm
Pantalla opal

Note: the filter and the screen must be ordered together with the lighting fixture - **Nota:** il filtro e lo schermo devono essere ordinati congiuntamente all'apparecchio - **Note:** le filtre et l'écran doivent être commandées en même temps que l'appareil
Anmerkung: müssen der Filter und der Bildschirm zusammen mit Leuchtkörper bestellt werden
Nota: el filtro y la pantalla deben pedirse juntos con la luminaria

AL7022

24VDC/500mA constant current converter
Convertitore 24VDC/500mA corrente costante
Convertisseur 24VDC/500mA courant constant
24VDC/500mA konstanter Strom konverter
Convertidor 24VDC/500mA corriente constante

Drivers

Alimentatori - Alimentateurs
Netzteile - Alimentadores

350 mA		500 mA	
on/off	dimmable	on/off	dimmable
AL1034 (1..3) 30mm IP20	AL4000 (1..4) 72mm IP20 PUSH 0/1..10V	AL1074 (1..2) 30mm IP20	AL4010 (1..4) 72mm IP20 PUSH 0/1..10V
AL1035 (1..3) 40mm IP20	AL4051 (1..4) 72mm IP20 DALI 2	AL1077 (1..2) 40mm IP20	AL4151 (1..4) 72mm IP20 DALI 2
AL1037 (1..5) 55mm IP20 S.P.	AL4053 (1..4) 56mm IP20 PUSH IGBT-TRIAC	AL1084 (1..3) 55mm IP20 S.P.	AL4153 (1..4) 56mm IP20 PUSH IGBT-TRIAC

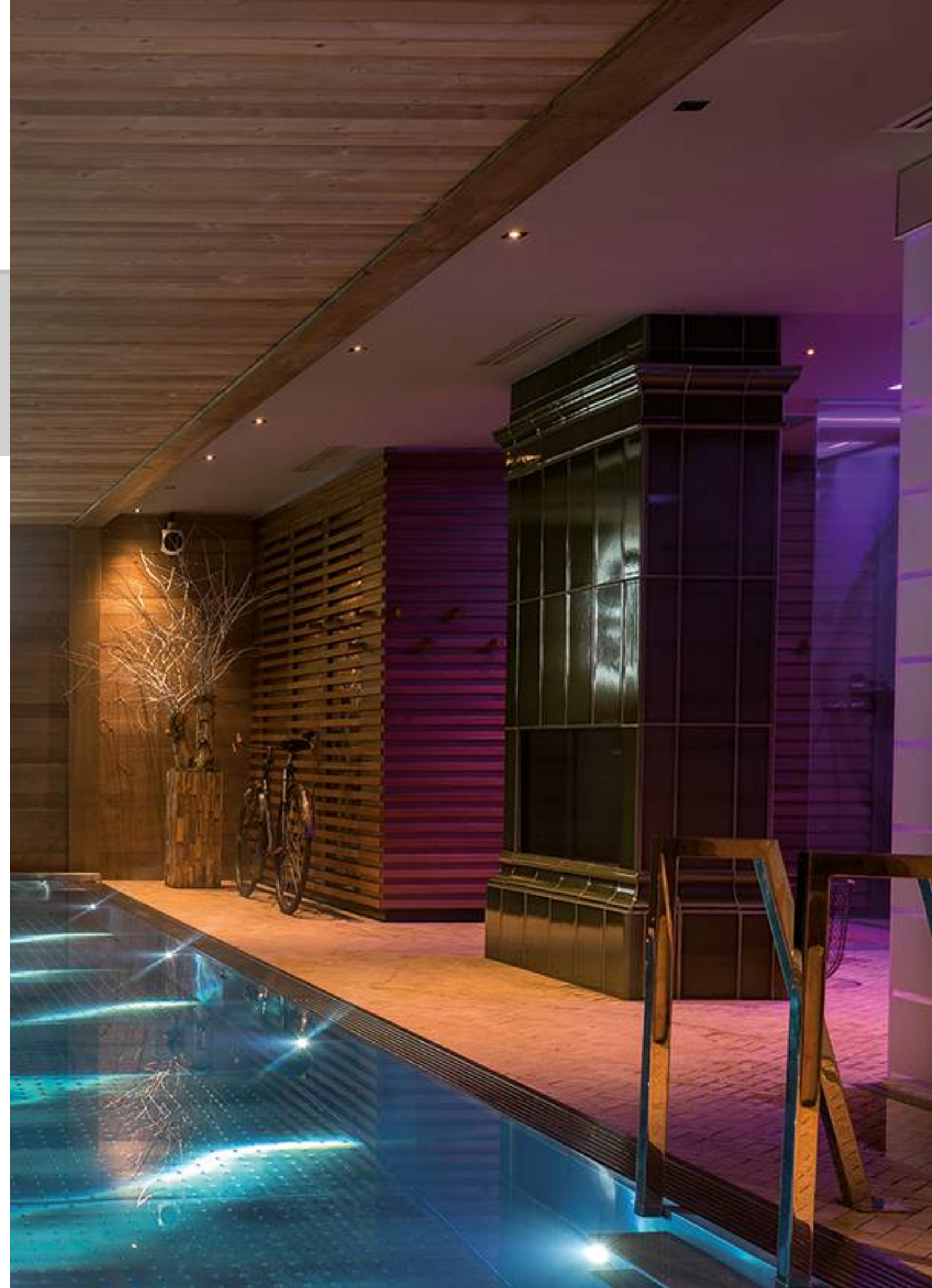

BABA Q6 EVO

design: Roberto Mantovani

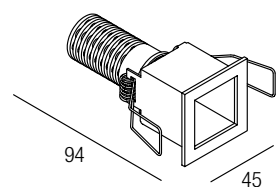

Supply current

Alimentazione
 Courant d'alimentation
 Stromversorgung
 Corriente de alimentación
500 mA (V_i 9V)

Power

Potenza
 Pouissance
 Bestuekung
 Potencia
6 W

Series wiring

Cablaggio in serie
 Câblage en série
 Verkabelung in Serie
 Cableado en serie



CCT/CRI/Flux

2700K — 540 lm
 3000K — 600 lm
 4000K — 620 lm

Photometric diagrams

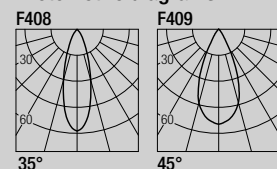

CRI98

2-Step MacAdam

Code Construction

Costruzione del codice - Construction du code produit
 Bau der Produkt-Code - Construcción del código de producto

BWE2 X X X

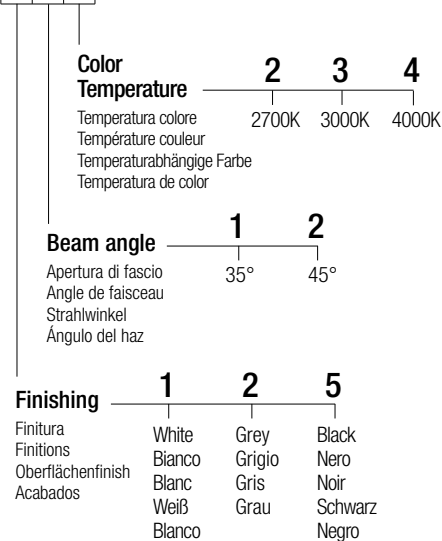

Accessories

Accessori - Accessoires
 Zubehör - Accesorios

LBWE201

Low luminance louver
 Filtro antiabbagliamento
 Filtre basse luminance
 Geringe Leuchtdichte-Filter
 Filtro de baja luminancia

SBWE201

Milky screen
 Schermo opale
 Écran opale
 Opal-Bildschirm
 Pantalla opal

Note: the filter and the screen must be ordered together with the lighting fixture - **Nota:** il filtro e lo schermo devono essere ordinati congiuntamente all'apparecchio - **Note:** le filtre et l'écran doivent être commandées en même temps que l'appareil
Anmerkung: müssen der Filter und der Bildschirm zusammen mit Leuchtkörper bestellt werden
Nota: el filtro y la pantalla deben pedirse juntos con la luminaria

AL7022

24VDC/500mA constant current converter
 Convertitore 24VDC/500mA corrente costante
 Convertisseur 24VDC/500mA courant constant
 24VDC/500mA konstanter Strom konverter
 Convertidor 24VDC/500mA corriente constante

Drivers

Alimentatori - Alimentateurs
 Netzteile - Alimentadores

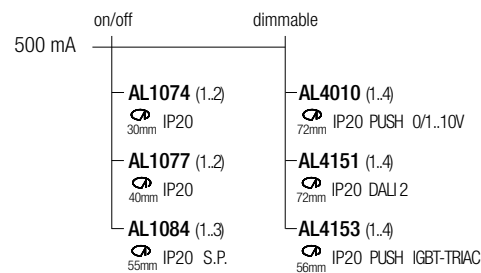

BABA R10

design: Roberto Mantovani

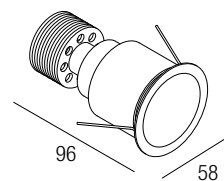

Supply current

Alimentazione
Courant d'alimentation
Stromversorgung
Corriente de alimentación

500 mA (V_i 18V)

Power

Potenza
Puissance
Bestuekung
Potencia

10 W

Series wiring

Cablaggio in serie
Câblage en série
Verkabelung in Serie
Cableado en serie



CCT/CRI/Flux

CCT	CRI85	CRI93
2700K	890lm	840lm
3000K	1000lm	930lm
4000K	1040lm	960lm

CRI85-93

2-Step MacAdam

Photometric diagrams

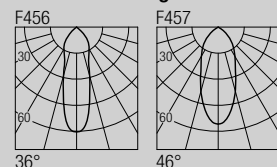

Code Construction

Costruzione del codice - Construction du code produit
Bau der Produkt-Code - Construcción del código de producto

BAR1 X X X X

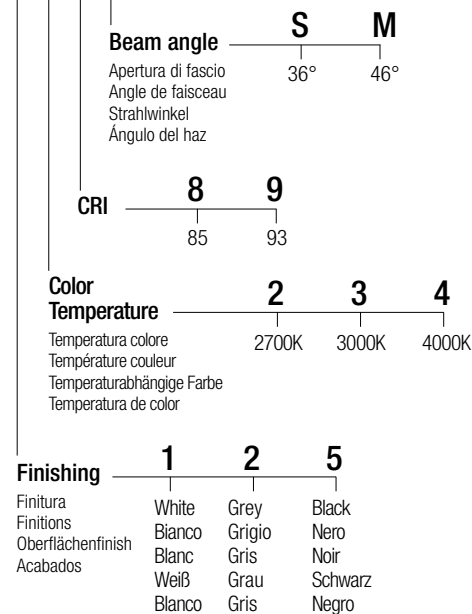

Accessories

Accessori - Accessoires
Zubehör - Accesorios

CSBT10

Recessing box
Controcassa
Boîtier d'encastrement
Eingieβgehäuse
Caja de empotrar

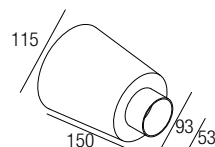

LBAR101

Low luminance louver
Filtro antiabbagliamento
Filtre basse luminance
Geringe Leuchtdichte-Filter
Filtro de baja luminancia



SBAR101

Milky screen
Schermo opale
Écran opale
Opal-Bildschirm
Pantalla opal



Note: the filter and the screen must be ordered together with the lighting fixture - **Nota:** il filtro e lo schermo devono essere ordinati congiuntamente all'apparecchio - **Note:** le filtre et l'écran doivent être commandées en même temps que l'appareil
Anmerkung: müssen der Filter und der Bildschirm zusammen mit Leuchtkörper bestellt werden
Nota: el filtro y la pantalla deben pedirse juntos con la luminaria

AL7022

24VDC/500mA constant current converter
Convertitore 24VDC/500mA corrente costante
Convertisseur 24VDC/500mA courant constant
24VDC/500mA konstanter Strom konverter
Convertidor 24VDC/500mA corriente constante

Drivers

Alimentatori - Alimentateurs
Netzteile - Alimentadores

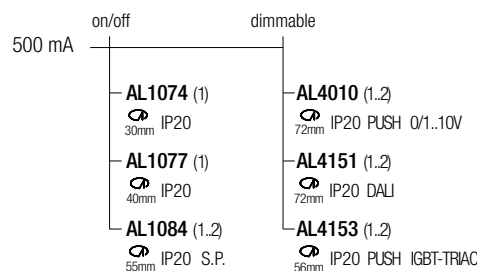

BABA R14

design: Roberto Mantovani

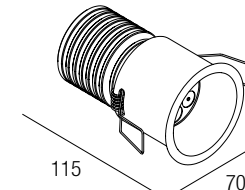

Supply current

Alimentazione
Courant d'alimentation
Stromversorgung
Corriente de alimentación

350-500 mA (V_i 20,3V)

Power

Potenza
Puissance
Bestuekung
Potencia

7-14 W

Series wiring

Cablaggio in serie
Câblage en série
Verkabelung in Serie
Cableado en serie



CCT/CRI/Flux

CCT	350mA	500mA
2700K	623 lm	896 lm
3000K	651 lm	931 lm
4200K	721 lm	1078 lm
6000K	798 lm	1155 lm

CRI85

2-Step MacAdam

Photometric diagrams

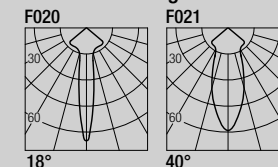

Code Construction

Costruzione del codice - Construction du code produit
Bau der Produkt-Code - Construcción del código de producto

BZ1 X X X

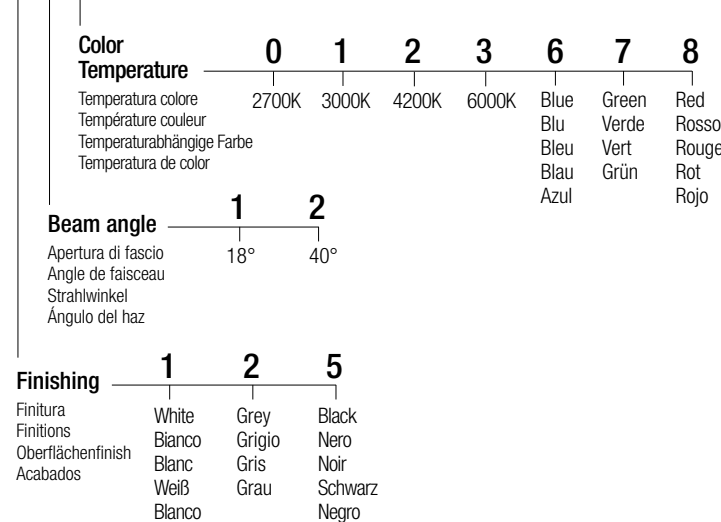

Accessories

Accessori - Accessoires
Zubehör - Accesorios

LBZ101

Low luminance louver
Filtro antiabbagliamento
Filtre basse luminance
Geringe Leuchtdichte-Filter
Filtro de baja luminancia



Note: the filter must be ordered together with the lighting fixture - **Nota:** il filtro deve essere ordinato congiuntamente all'apparecchio - **Note:** le filtre doit être commandé en même temps que l'appareil - **Anmerkung:** muss der Filter zusammen mit Leuchtkörper bestellt werden
Nota: el filtro debe pedirse junto con la luminaria

Drivers

Alimentatori - Alimentateurs
Netzteile - Alimentadores

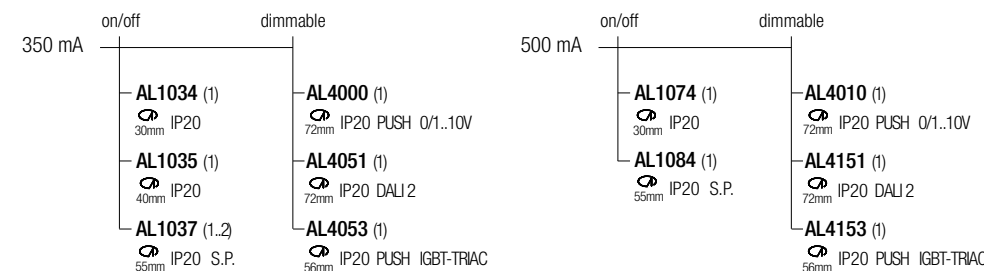

FRANNY 6

design: Rod&Todd

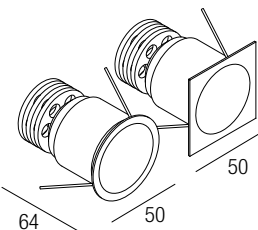

Supply current

Alimentazione
 Courant d'alimentation
 Stromversorgung
 Corriente de alimentación
500 mA (V, 9V)

Power

Potenza
 Pouissance
 Bestuekung
 Potencia
6 W

Series wiring

Cablaggio in serie
 Câblage en série
 Verkabelung in Serie
 Cableado en serie



CCT/CRI/Flux

2700K — 540 lm
 3000K — 600 lm
 4000K — 620 lm

CRI98

2-Step MacAdam

Photometric diagrams

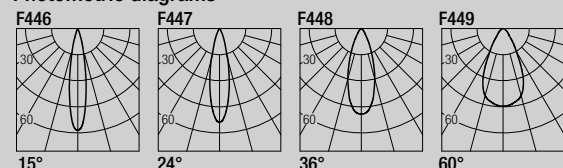

Code Construction

Costruzione del codice - Construction du code produit
 Bau der Produkt-Code - Construcción del código de producto

FN6 X X X X

Beam angle
 Apertura di fascio
 Angle de faisceau
 Strahlwinkel
 Ángulo del haz

N	S	M	W
15°	24°	36°	60°

Color Temperature
 Temperatura colore
 Température couleur
 Temperaturabhängige Farbe
 Temperatura de color

2	3	4
2700K	3000K	4000K

Finishing
 Finitura
 Finitions
 Oberflächenfinish
 Acabados

1	5
White Bianco Blanc Weiß Blanco	Black Nero Noir Schwarz Negro

Shape
 Forma
 Forme
 Form

1	2
Round Tondo Ronde Runde Redondo	Square Quadro Carré Quadrat Cuadrado

Drivers

Alimentatori - Alimentateurs
 Netzteile - Alimentadores

on/off	dimnable
500 mA	
AL1074 (1..2) 30mm IP20	AL4010 (1..4) 72mm IP20 PUSH 0/1..10V
AL1077 (1..2) 40mm IP20	AL4151 (1..4) 72mm IP20 DALI 2
AL1084 (1..3) 55mm IP20 S.P.	AL4153 (1..4) 56mm IP20 PUSH IGBT-TRIAC

Accessories

Accessori - Accessoires
 Zubehör - Accesorios

CSFB01

Recessing box
 Controcassa
 Boîtier d'encastrement
 Eingießgehäuse
 Caja de empotrar

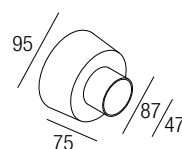

LFN601

Low luminance louver
 Filtro antiabbagliamento
 Filtre basse luminance
 Geringe Leuchtdichte-Filter
 Filtro de baja luminancia



SFN601

Milky screen
 Schermo opale
 Ecran opale
 Opal-Bildschirm
 Pantalla opal



Note: the filter and the screen must be ordered together with the lighting fixture - **Nota:** il filtro e lo schermo devono essere ordinati congiuntamente all'apparecchio - **Note:** le filtre et l'écran doivent être commandées en même temps que l'appareil
Anmerkung: müssen der Filter und der Bildschirm zusammen mit Leuchtkörper bestellt werden
Nota: el filtro y la pantalla deben pedirse juntos con la luminaria

AL7022

24VDC/500mA constant current converter
 Convertitore 24VDC/500mA corrente costante
 Convertisseur 24VDC/500mA courant constant
 24VDC/500mA konstanter Strom konverter
 Convertidor 24VDC/500mA corriente constante



FRANNY 10

design: Rod&Todd

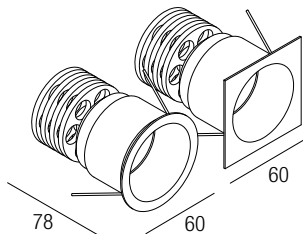

Supply current

Alimentazione
Courant d'alimentation
Stromversorgung
Corriente de alimentación
500 mA (V_i 18V)

Power

Potenza
Puissance
Bestuekung
Potencia
10 W

Series wiring

Cablaggio in serie
Câblage en série
Verkabelung in Serie
Cableado en serie



Photometric diagrams

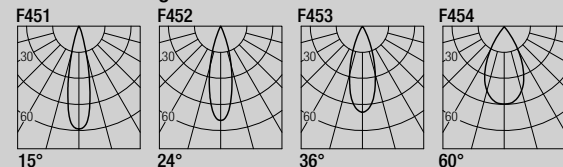

CCT/CRI/Flux

	CRI85	CRI93
2700K	890 lm	840 lm
3000K	1000 lm	930 lm
4000K	1040 lm	960 lm

CRI85 - CRI93

2-Step MacAdam

Code Construction

Costruzione del codice - Construction du code produit
Bau der Produkt-Code - Construcción del código de producto

FN1 X X X X X

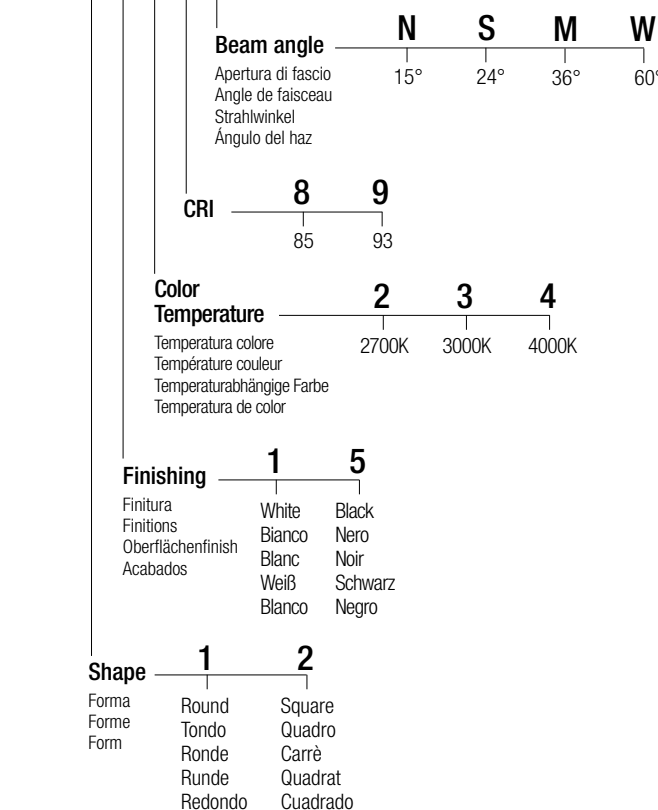

Drivers

Alimentatori - Alimentateurs
Netzteile - Alimentadores

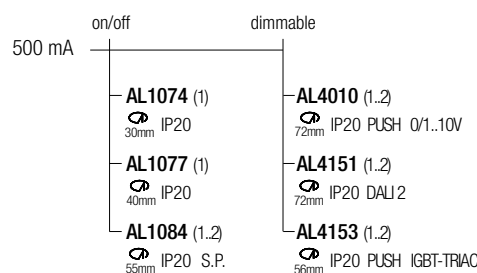

FRANNY 724

design: Rod&Todd

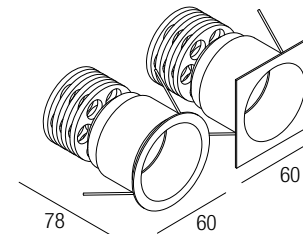

Supply current

Alimentazione
Courant d'alimentation
Stromversorgung
Corriente de alimentación
24 VDC

Power

Potenza
Puissance
Bestuekung
Potencia
7 W

Parallel wiring

Cablaggio in parallelo
Câblage en parallèle
Verkabelung in parallel
Cableado en paralelo



Photometric diagrams

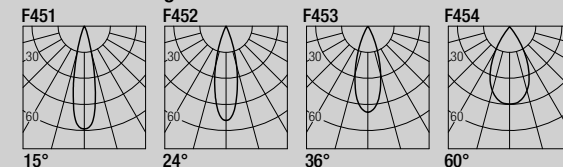

CCT/CRI/Flux

	CRI85	CRI93
2700K	630 lm	590 lm
3000K	700 lm	650 lm
4000K	730 lm	670 lm

CRI85 - CRI93

2-Step MacAdam

Code Construction

Costruzione del codice - Construction du code produit
Bau der Produkt-Code - Construcción del código de producto

FN24 X X X X X

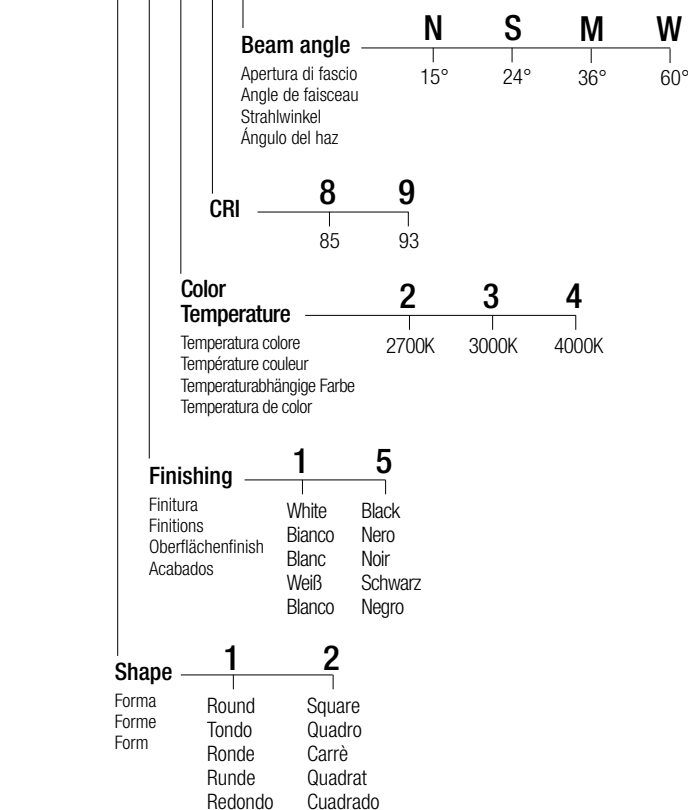

Drivers

Alimentatori - Alimentateurs
Netzteile - Alimentadores

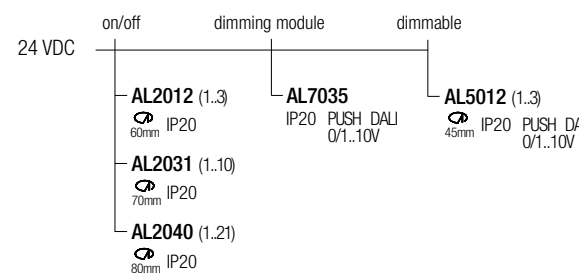

Note: dimming module AL7035 to be used in combination with an on/off 24VDC power supply
Nota: modulo di dimmerazione AL7035 da utilizzare in combinazione con un alimentatore on/off 24VDC
Note: module de variation AL7035 d'intensité à utiliser en combinaison avec une alimentation on/off 24VDC
Anmerkung: Dimmmodul AL7035 zur Verwendung in Kombination mit einem on/off 24VDC-Netzteil
Nota: módulo de regulación AL7035 se utiliza en combinación con una fuente de alimentación on/off 24VDC

Accessories

Accessori - Accessoires
Zubehör - Accesorios

CSFX01

Recessing box
Controcassa
Boîtier d'encastrement
Eingießgehäuse
Caja de empotrar

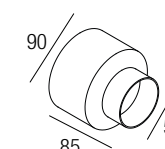

LFN2401

Low luminance louver
Filtro antiabbagliamento
Filtre basse luminance
Geringe Leuchtdichte-Filter
Filtro de baja luminancia



SFN2401

Milky screen
Schermo opale
Écran opale
Opal-Bildschirm
Pantalla opal



Note: the filter and the screen must be ordered together with the lighting fixture - **Nota:** il filtro e lo schermo devono essere ordinati congiuntamente all'apparecchio - **Note:** le filtre et l'écran doivent être commandées en même temps que l'appareil
Anmerkung: müssen der Filter und der Bildschirm zusammen mit Leuchtkörper bestellt werden
Nota: el filtro y la pantalla deben pedirse juntos con la luminaria

LEAF 6 UGR

design: Roberto Mantovani

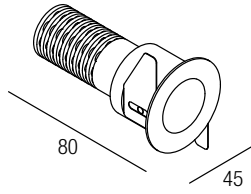

Supply current

Alimentazione
Courant d'alimentation
Stromversorgung
Corriente de alimentación
500 mA (V_I 9V)

Power

Potenza
Puissance
Bestuekung
Potencia
6 W

Series wiring

Cablaggio in serie
Câblage en série
Verkabelung in Serie
Cableado en serie



CCT/CRI/Flux

2700K — **540 lm**
3000K — **600 lm**
4000K — **620 lm**

CRI98

2-Step MacAdam

Photometric diagrams

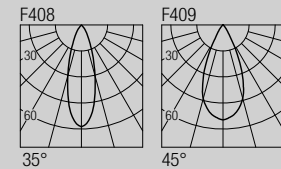

Code Construction

Costruzione del codice - Construction du code produit
Bau der Produkt-Code - Construcción del código de producto

LFU6 X X X

Color Temperature 2 3 4
Temperatura colore 2700K 3000K 4000K
Température couleur
Temperaturabhängige Farbe
Temperatura de color

Beam angle 1 2
Apertura di fascio 35° 45°
Angle de faisceau
Strahlwinkel
Ángulo del haz

Finishing 1 2 5
Finitura Bianco Grigio Nero
Finitions Blanc Gris Noir
Oberflächenfinish Weiß Grau Schwarz
Acabados Blanco Gris Negro

Drivers

Alimentatori - Alimentateurs
Netzteile - Alimentadores

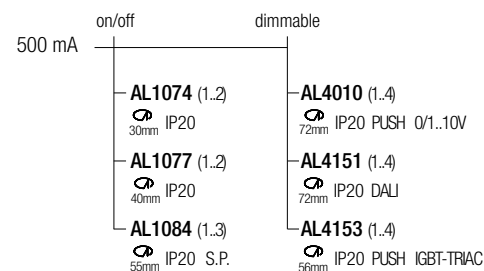

LEAF 10 UGR

design: Roberto Mantovani

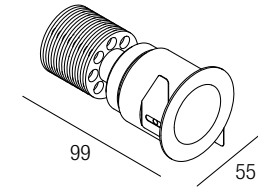

Supply current

Alimentazione
Courant d'alimentation
Stromversorgung
Corriente de alimentación
500 mA (V_I 9V)

Power

Potenza
Puissance
Bestuekung
Potencia
10 W

Series wiring

Cablaggio in serie
Câblage en série
Verkabelung in Serie
Cableado en serie



CCT/CRI/Flux

2700K — **890lm** CRI85
3000K — **1000lm** CRI93
4000K — **1040lm** CRI93

CRI85-93

2-Step MacAdam

Photometric diagrams

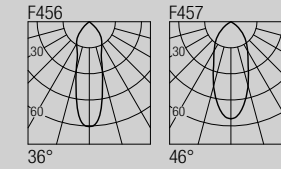

Code Construction

Costruzione del codice - Construction du code produit
Bau der Produkt-Code - Construcción del código de producto

LFU1 X X X X

Beam angle S M
Apertura di fascio 36° 46°
Angle de faisceau
Strahlwinkel
Ángulo del haz

CRI 8 9
85 93

Color Temperature 2 3 4
Temperatura colore 2700K 3000K 4000K
Température couleur
Temperaturabhängige Farbe
Temperatura de color

Finishing 1 2 5
Finitura Bianco Grigio Nero
Finitions Blanc Gris Noir
Oberflächenfinish Weiß Grau Schwarz
Acabados Blanco Gris Negro

Drivers

Alimentatori - Alimentateurs
Netzteile - Alimentadores

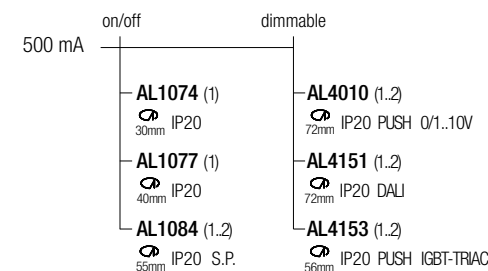

[DATASHEET](#) [INSTALLATION MANUAL](#)
[CERTIFICATIONS](#) [LDT-IES](#) [DRAWINGS](#)

[DATASHEET](#) [INSTALLATION MANUAL](#)
[CERTIFICATIONS](#) [LDT-IES](#) [DRAWINGS](#)

Accessories

Accessori - Accessoires
Zubehör - Accesorios

LLFU601

Low luminance louver
Filtro antiabbagliamento
Filtre basse luminance
Geringe Leuchtdichte-Filter
Filtro de baja luminancia

SLFU601

Milky screen
Schermo opale
Écran opale
Opal-Bildschirm
Pantalla opal

Note: the filter and the screen must be ordered together with the lighting fixture - **Nota:** il filtro e lo schermo devono essere ordinati congiuntamente all'apparecchio - **Note:** le filtre et l'écran doivent être commandées en même temps que l'appareil
Anmerkung: müssen der Filter und der Bildschirm zusammen mit Leuchtkörper bestellt werden
Nota: el filtro y la pantalla deben pedirse juntos con la luminaria

AL7022

24VDC/500mA constant current converter
Convertitore 24VDC/500mA corrente costante
Convertisseur 24VDC/500mA courant constant
24VDC/500mA konstanter Strom konverter
Convertidor 24VDC/500mA corriente constante

Accessories

Accessori - Accessoires
Zubehör - Accesorios

LLFU101

Low luminance louver
Filtro antiabbagliamento
Filtre basse luminance
Geringe Leuchtdichte-Filter
Filtro de baja luminancia

SLFU101

Milky screen
Schermo opale
Écran opale
Opal-Bildschirm
Pantalla opal

Note: the filter and the screen must be ordered together with the lighting fixture - **Nota:** il filtro e lo schermo devono essere ordinati congiuntamente all'apparecchio - **Note:** le filtre et l'écran doivent être commandées en même temps que l'appareil
Anmerkung: müssen der Filter und der Bildschirm zusammen mit Leuchtkörper bestellt werden
Nota: el filtro y la pantalla deben pedirse juntos con la luminaria

AL7022

24VDC/500mA constant current converter
Convertitore 24VDC/500mA corrente costante
Convertisseur 24VDC/500mA courant constant
24VDC/500mA konstanter Strom konverter
Convertidor 24VDC/500mA corriente constante

MACAIA

design: Roberto Mantovani

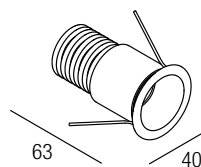

Supply current
Alimentazione
Courant d'alimentation
Stromversorgung
Corriente de alimentación
24 VDC

Power
Potenza
Puissance
Bestuekung
Potencia
2 W

Parallel wiring
Cablaggio in parallelo
Câblage en parallèle
Verkabelung in parallel
Cableado en paralelo



CCT/CRI/Flux

2700K — 128 lm
3000K — 133 lm
4200K — 154 lm

Photometric diagrams

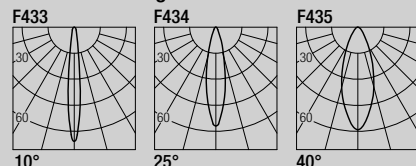

CRI85
2-Step MacAdam

Code Construction

Costruzione del codice - Construction du code produit
Bau der Produkt-Code - Construcción del código de producto

MC1 X X X

Color Temperature 0 1 2
Temperatura colore 2700K 3000K 4200K
Température couleur
Temperaturabhängige Farbe
Temperatura de color

Beam angle 0 1 2
Apertura di fascio 10° 25° 40°
Angle de faisceau
Strahlwinkel
Ángulo del haz

Finishing B N
Finitura White Black
Finitions Bianco Nero
Oberflächenfinish Blanc Noir
Acabados Weiß Schwarz
Blanco Negro

Accessories

Accessori - Accessoires
Zubehör - Accesorios

LMC101

Low luminance louver
Filtro antiabbagliamento
Filtre basse luminance
Geringe Leuchtdichte-Filter
Filtro de baja luminancia

Note: the filter must be ordered together with the lighting fixture - **Nota:** il filtro deve essere ordinato congiuntamente all'apparecchio - **Note:** le filtre doit être commandé en même temps que l'appareil - **Anmerkung:** muss der Filter zusammen mit Leuchtkörper bestellt werden
Nota: el filtro debe pedirse junto con la luminaria

Drivers

Alimentatori - Alimentateurs
Netzteile - Alimentadores



Note: dimming module AL7035 to be used in combination with an on/off 24VDC power supply
Nota: modulo di dimmerazione AL7035 da utilizzare in combinazione con un alimentatore on/off 24VDC
Note: module de variation AL7035 d'intensité à utiliser en combinaison avec une alimentation on/off 24VDC
Anmerkung: Dimmmodul AL7035 zur Verwendung in Kombination mit einem on/off 24VDC-Netzteil
Nota: módulo de regulación AL7035 se utiliza en combinación con una fuente de alimentación on/off 24VDC



NEIL

design: Roberto Mantovani

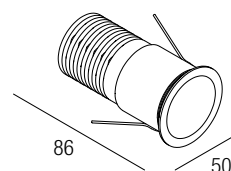

Supply current

Alimentazione
Courant d'alimentation
Stromversorgung
Corriente de alimentación
24 VDC

Power

Potenza
Pouissance
Bestuekung
Potencia
7 W

Parallel wiring

Cablaggio in parallelo
Câblage en parallèle
Verkabelung in parallel
Cableado en paralelo



Photometric diagrams

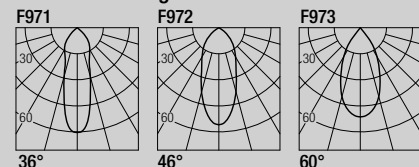

CCT/CRI/Flux

	CRI85	CRI93
2700K	630 lm	590 lm
3000K	700 lm	650 lm
4000K	730 lm	670 lm

CRI85 - CRI93
2-Step MacAdam

Code Construction

Costruzione del codice - Construction du code produit
Bau der Produkt-Code - Construcción del código de producto

NL X X X X

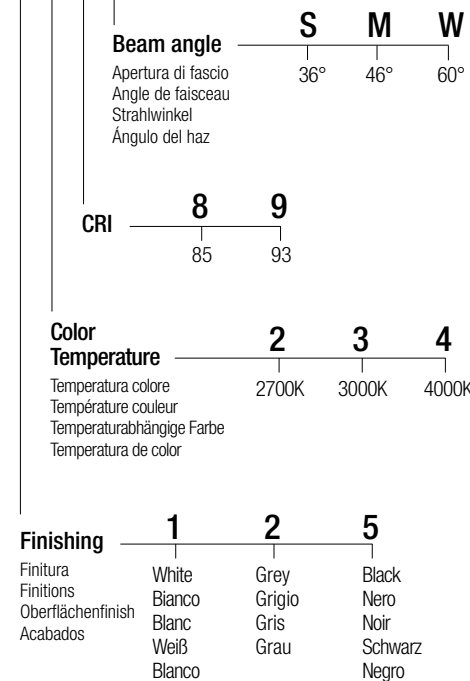

Drivers

Alimentatori - Alimentateurs
Netzteile - Alimentadores

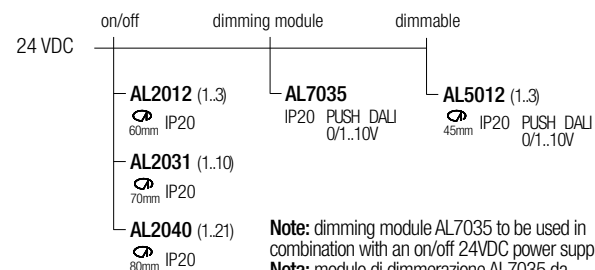

Note: dimming module AL7035 to be used in combination with an on/off 24VDC power supply
Nota: modulo di dimmerazione AL7035 da utilizzare in combinazione con un alimentatore on/off 24VDC
Note: module de variation AL7035 d'intensité à utiliser en combinaison avec une alimentation on/off 24VDC
Anmerkung: Dimmmodul AL7035 zur Verwendung in Kombination mit einem on/off 24VDC-Netzteil
Nota: módulo de regulación AL7035 se utiliza en combinación con una fuente de alimentación on/off 24VDC



CORE 2

design: Lapo Grassellini

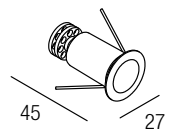

Supply current
 Alimentazione
 Courant d'alimentation
 Stromversorgung
 Corriente de alimentación
350-500 mA (V_i 2,9V)

Power
 Potenza
 Pouissance
 Bestuekung
 Potencia
1-2 W

Series wiring
 Cablaggio in serie
 Câblage en série
 Verkabelung in Serie
 Cableado en serie



CCT/CRI/Flux

	350mA	500mA
2700K	89 lm	128 lm
3000K	93 lm	133 lm
4200K	103 lm	154 lm

Photometric diagrams

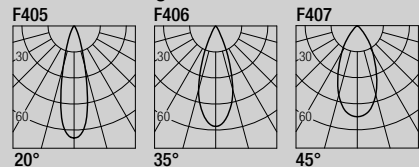

CRI85
 2-Step MacAdam

Code Construction

Costruzione del codice - Construction du code produit
 Bau der Produkt-Code - Construcción del código de producto

CE2 X, X, X

Beam angle

	S	M	W
Apertura di fascio	20°	35°	45°
Angle de faisceau			
Strahlwinkel			
Ángulo del haz			

Color Temperature

	2	3	4
Temperatura colore	2700K	3000K	4200K
Température couleur			
Temperaturabhängige Farbe			
Temperatura de color			

Finishing

	1	2	5
Finitura	White	Grey	Black
Finitions	Bianco	Grigio	Nero
Oberflächenfinish	Blanc	Gris	Noir
Acabados	Weiß	Grau	Schwarz
	Blanco		Negro

Accessories

Accessori - Accessoires
 Zubehör - Accesorios

AL7022

24VDC/500mA constant current converter
 Convertitore 24VDC/500mA corrente costante
 Convertisseur 24VDC/500mA courant constant
 24VDC/500mA konstanter Strom konverter
 Convertidor 24VDC/500mA corriente constante

Drivers

Alimentatori - Alimentateurs
 Netzteile - Alimentadores

	on/off	dimnable
350 mA	<ul style="list-style-type: none"> AL1034 (1.11) 30mm IP20 AL1035 (1.11) 40mm IP20 AL1037 (1.16) 55mm IP20 S.P. 	<ul style="list-style-type: none"> AL4000 (1.12) 72mm IP20 PUSH 0/1..10V AL4051 (2.14) 72mm IP20 DALI2 AL4053 (1.14) 56mm IP20 PUSH IGBT-TRIAC
500 mA	<ul style="list-style-type: none"> AL1074 (1.7) 30mm IP20 AL1077 (1.6) 40mm IP20 AL1084 (1.11) 55mm IP20 S.P. 	<ul style="list-style-type: none"> AL4010 (1.12) 72mm IP20 PUSH 0/1..10V AL4151 (2.14) 72mm IP20 DALI2 AL4153 (1.14) 56mm IP20 PUSH IGBT-TRIAC



CORE 6

design: Lapo Grassellini

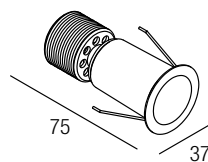

Supply current

Alimentazione
Courant d'alimentation
Stromversorgung
Corriente de alimentación

500 mA (V, 9V)

Power

Potenza
Puissance
Bestuekung
Potencia

6 W

Series wiring

Cablaggio in serie
Câblage en série
Verkabelung in Serie
Cableado en serie



CCT/CRI/Flux

2700K — 540 lm
3000K — 600 lm
4000K — 620 lm

Photometric diagrams

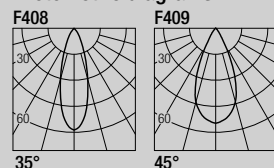

CRI98

2-Step MacAdam

Code Construction

Costruzione del codice - Construction du code produit
Bau der Produkt-Code - Construcción del código de producto

CE6 X, X, X

Beam angle — S — M
Apertura di fascio — 35° — 45°
Angle de faisceau
Strahlwinkel
Ángulo del haz

Color Temperature — 2 — 3 — 4
Temperatura colore — 2700K — 3000K — 4000K
Température couleur
Temperaturabhängige Farbe
Temperatura de color

Finishing — 1 — 2 — 5
Finitura — White — Grey — Black
Finitions — Bianco — Grigio — Nero
Oberflächenfinish — Blanc — Gris — Noir
Acabados — Weiß — Grau — Schwarz
Blanco — Negro

Accessories

Accessori - Accessoires
Zubehör - Accesorios

LCE601

Low luminance louver
Filtro antiabbagliamento
Filtre basse luminance
Geringe Leuchtdichte-Filter
Filtro de baja luminancia



SCE601

Milky screen
Schermo opale
Écran opale
Opal-Bildschirm
Pantalla opal



Note: the filter and the screen must be ordered together with the lighting fixture - **Nota:** il filtro e lo schermo devono essere ordinati congiuntamente all'apparecchio - **Note:** le filtre et l'écran doivent être commandées en même temps que l'appareil
Anmerkung: müssen der Filter und der Bildschirm zusammen mit Leuchtkörper bestellt werden
Nota: el filtro y la pantalla deben pedirse juntos con la luminaria

AL7022

24VDC/500mA constant current converter
Convertitore 24VDC/500mA corrente costante
Convertisseur 24VDC/500mA courant constant
24VDC/500mA konstanter Strom konverter
Convertidor 24VDC/500mA corriente constante

Drivers

Alimentatori - Alimentateurs
Netzteile - Alimentadores

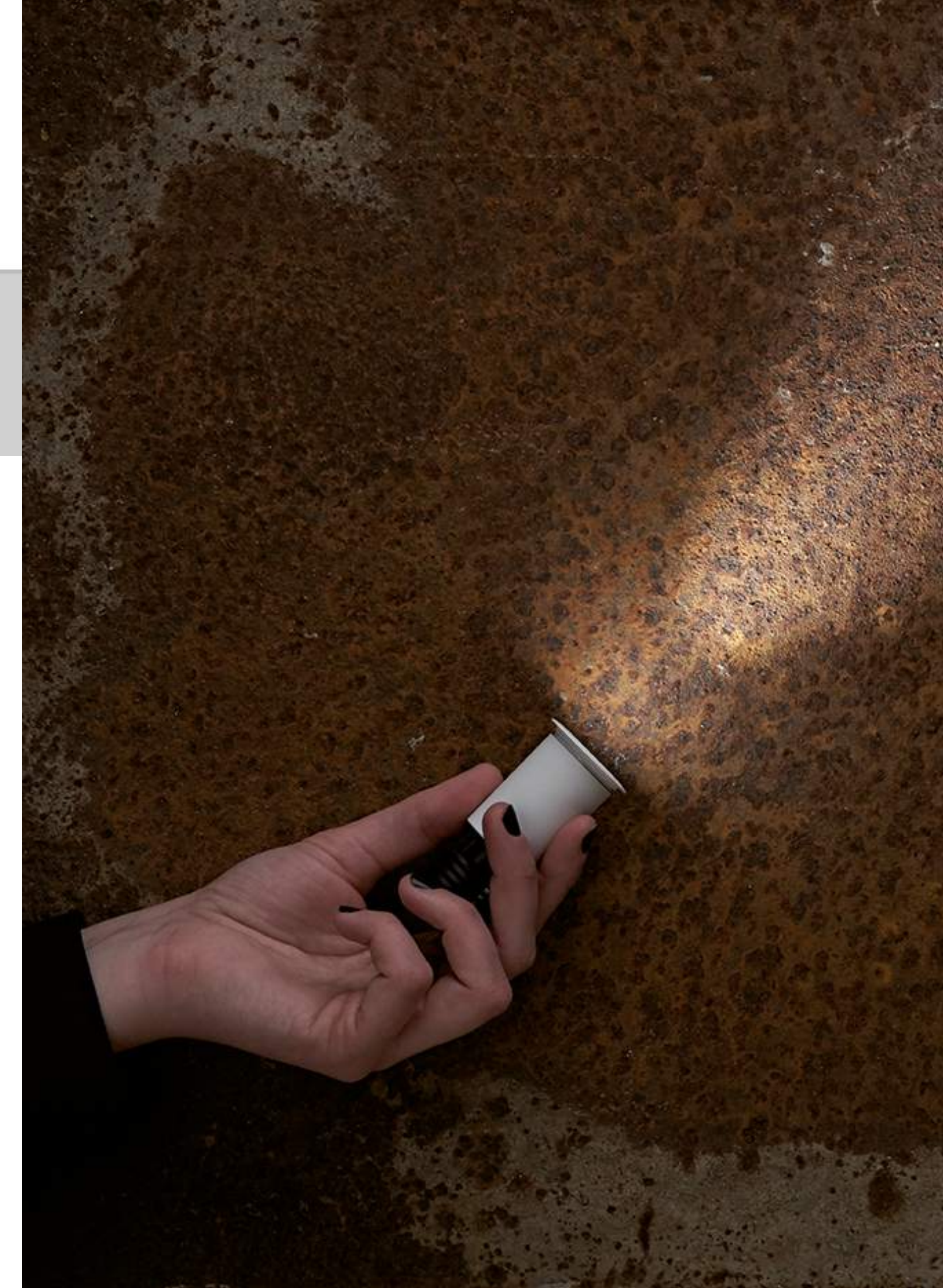
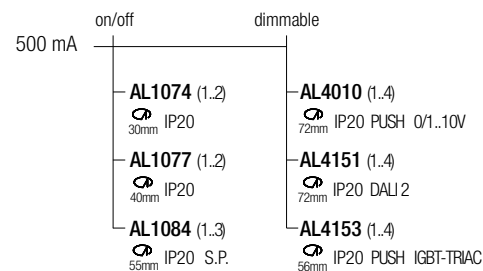

CORE 10

design: Lapo Grassellini

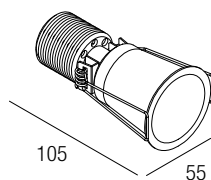

Supply current

Alimentazione
Courant d'alimentation
Stromversorgung
Corriente de alimentación

250 mA (V, 36V)

Power

Potenza
Puissance
Bestuekung
Potencia

10 W



Photometric diagrams

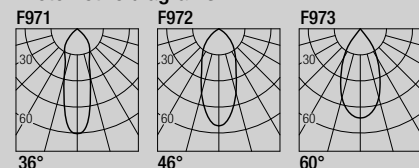

CCT/CRI/Flux

	CRI85	CRI93
2700K	890 lm	840 lm
3000K	1000 lm	930 lm
4000K	1040 lm	960 lm

CRI85 - CRI93
2-Step MacAdam

Code Construction

Costruzione del codice - Construction du code produit
Bau der Produkt-Code - Construcción del código de producto

C1 X X X X

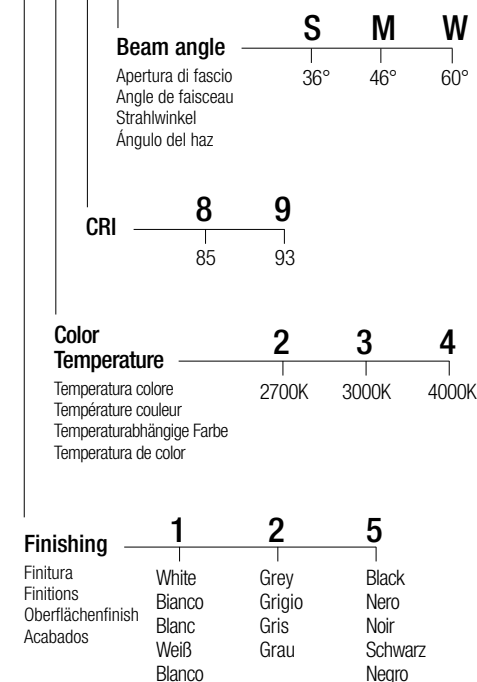

Accessories

Accessori - Accessoires
Zubehör - Accesorios

LOH1 LOH1B LOH1G

White Bianco Blanc Weiß Blanco	Black Nero Noir Schwarz Negro	Grey Grigio Gris Grau
--	---	--------------------------------

Low luminance louver
Filtro antiabbagliamento
Filtre basse luminance
Geringe Leuchtdichte-Filter
Filtro de baja luminancia

SC101

Milky screen
Schermo opale
Écran opale
Opal-Bildschirm
Pantalla opal

Note: the screen must be ordered together with the lighting fixture - **Nota:** lo schermo deve essere ordinato congiuntamente all'apparecchio - **Note:** l'écran doit être commandé en même temps que l'appareil

Anmerkung: muss der Bildschirm zusammen mit Leuchtkörper bestellt werden - **Nota:** la pantalla debe pedirse junta con la luminaria

Drivers

Alimentatori - Alimentateurs
Netzteile - Alimentadores

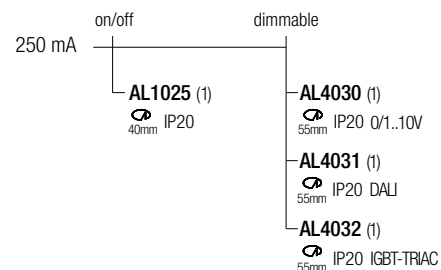

CORE 20

design: Lapo Grassellini

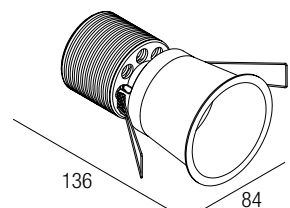

Supply current
 Alimentazione
 Courant d'alimentation
 Stromversorgung
 Corriente de alimentación
500 mA (V, 36V)

Power
 Potenza
 Puissance
 Bestuekung
 Potencia
20 W



CCT/CRI/Flux

CCT	CRI85	CRI93
2700K	1830 lm	1700 lm
3000K	2000 lm	1830 lm
4000K	2100 lm	1950 lm

Photometric diagrams

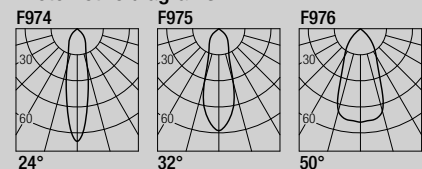

CRI85 - CRI93
2-Step MacAdam

Code Construction

Costruzione del codice - Construction du code produit
 Bau der Produkt-Code - Construcción del código de producto

C2 | **X** | **X** | **X** | **X**

Beam angle
 Apertura di fascio
 Angle de faisceau
 Strahlwinkel
 Ángulo del haz

S	M	W
24°	32°	50°

CRI

8	9
85	93

Color Temperature
 Temperatura colore
 Température couleur
 Temperaturabhängige Farbe
 Temperatura de color

2	3	4
2700K	3000K	4000K

Finishing

1	2	5
White	Grey	Black
Bianco	Grigio	Nero
Blanc	Gris	Noir
Weiß	Grau	Schwarz
Blanco		Negro

Accessories

Accessori - Accessoires
 Zubehör - Accesorios

LOH2 LOH2B LOH2G

White	Black	Grey
Bianco	Nero	Grigio
Blanc	Noir	Gris
Weiß	Schwarz	Grau
Bianco	Negro	

Low luminance louver
 Filtro antiabbagliamento
 Filtre basse luminance
 Geringe Leuchtdichte-Filter
 Filtro de baja luminancia

SC201

Milky screen
 Schermo opale
 Écran opale
 Opal-Bildschirm
 Pantalla opal

Note: the screen must be ordered together with the lighting fixture - **Nota:** lo schermo deve essere ordinato congiuntamente all'apparecchio - **Note:** l'écran doit être commandé en même temps que l'appareil

Anmerkung: muss der Bildschirm zusammen mit Leuchtörper bestellt werden - **Nota:** la pantalla debe pedirse junta con la luminaria

Drivers

Alimentatori - Alimentateurs
 Netzteile - Alimentadores

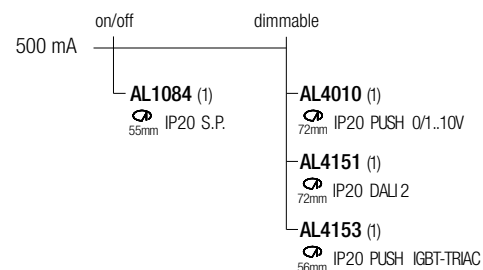

BLACK 2

design: Lapo Grassellini

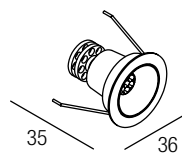

Supply current

Alimentazione
Courant d'alimentation
Stromversorgung
Corriente de alimentación

350-500 mA (V_i 2,9V)

Power

Potenza
Puissance
Bestuekung
Potencia

1-2 W

Series wiring

Cablaggio in serie
Câblage en série
Verkabelung in Serie
Cableado en serie



Photometric diagrams

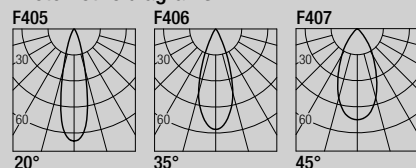

CCT/CRI/Flux

	350mA	500mA
2700K	89 lm	128 lm
3000K	93 lm	133 lm
4200K	103 lm	154 lm

CRI85

2-Step MacAdam

Code Construction

Costruzione del codice - Construction du code produit
Bau der Produkt-Code - Construcción del código de producto

BK1 X X X

Beam angle

	S	M	W
Apertura di fascio Angle de faisceau Strahlwinkel Ángulo del haz	20°	35°	45°

Color

Temperature	2	3	4
Temperatura colore Température couleur Temperaturabhängige Farbe Temperatura de color	2700K	3000K	4200K

Finishing

	1	2	5
Finitura Finitions Oberflächenfinish Acabados	White Blanco Weiß Blanco	Grey Gris Grau	Black Nero Schwarz Negro

Accessories

Accessori - Accessoires
Zubehör - Accesorios

AL7022

24VDC/500mA constant current converter
Convertitore 24VDC/500mA corrente costante
Convertisseur 24VDC/500mA courant constant
24VDC/500mA konstanter Strom konverter
Convertidor 24VDC/500mA corriente constante

Drivers

Alimentatori - Alimentateurs
Netzteile - Alimentadores

350 mA	on/off	dimmable
AL1034 (1..11)	30mm IP20	AL4000 (1..12)
AL1035 (1..11)	40mm IP20	AL4051 (2..14)
AL1037 (1..16)	55mm IP20 S.P.	AL4053 (1..14)
		72mm IP20 PUSH 0/1..10V
		72mm IP20 DALI 2
		56mm IP20 PUSH IGBT-TRIAC
500 mA	on/off	dimmable
AL1074 (1..7)	30mm IP20	AL4010 (1..12)
AL1077 (1..6)	40mm IP20	AL4151 (2..14)
AL1084 (1..11)	55mm IP20 S.P.	AL4153 (1..14)
		72mm IP20 PUSH 0/1..10V
		72mm IP20 DALI 2
		56mm IP20 PUSH IGBT-TRIAC

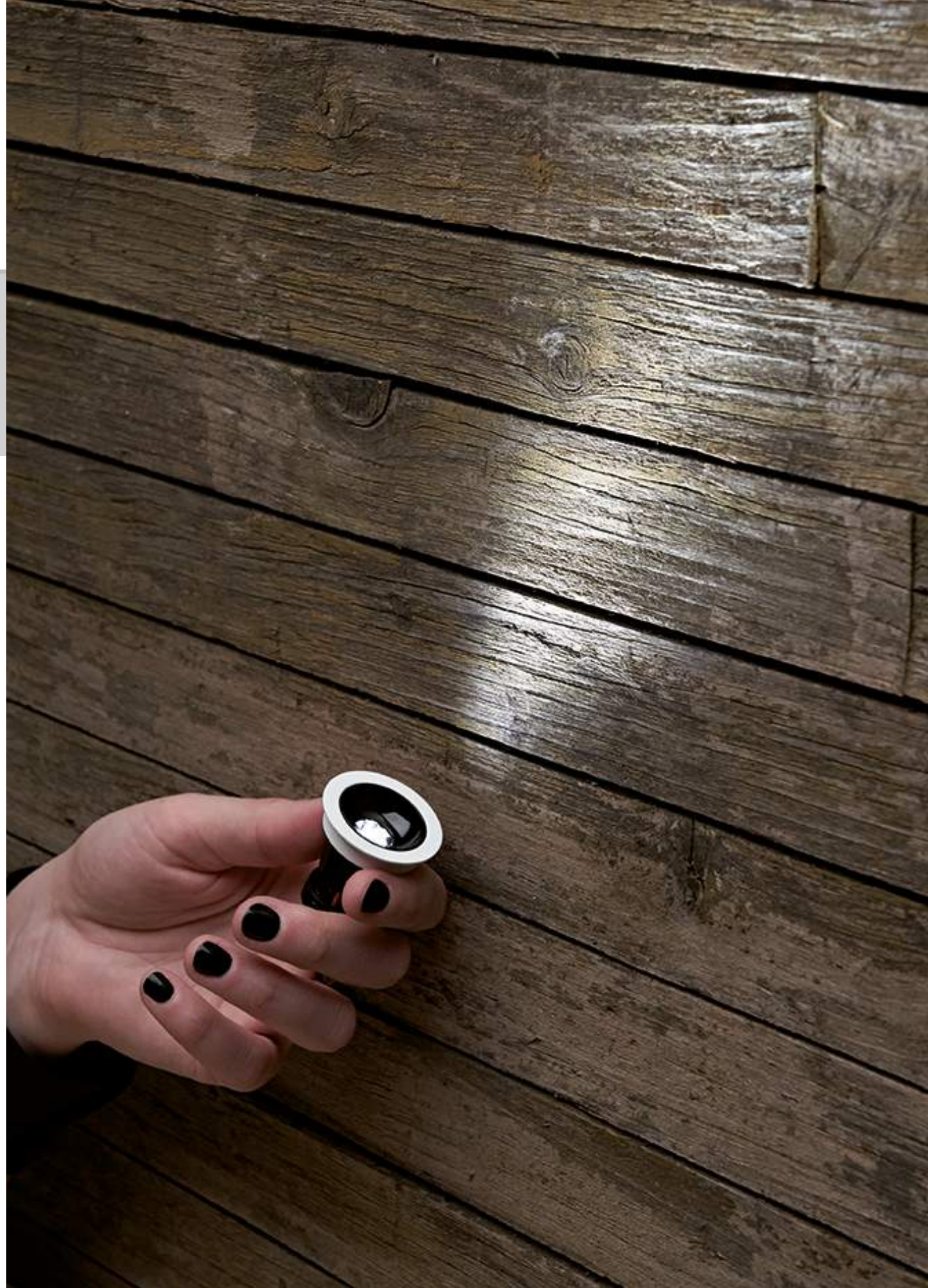

BLACK 6

design: Lapo Grassellini

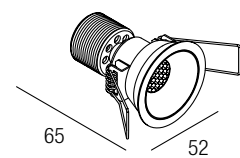

Supply current

Alimentazione
Courant d'alimentation
Stromversorgung
Corriente de alimentación

500 mA (V, 9V)

Power

Potenza
Puissance
Bestuekung
Potencia

6 W

Series wiring

Cablaggio in serie
Câblage en série
Verkabelung in Serie
Cableado en serie



CCT/CRI/Flux

Photometric diagrams

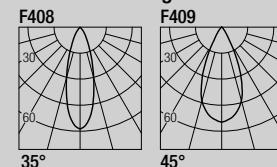

2700K — 540 lm
3000K — 600 lm
4000K — 620 lm

CRI98

2-Step MacAdam

Code Construction

Costruzione del codice - Construction du code produit
Bau der Produkt-Code - Construcción del código de producto

BK2 X X X

Beam angle

Apertura di fascio
Angle de faisceau
Strahlwinkel
Ángulo del haz

S M
35° 45°

Color Temperature

Temperatura colore
Température couleur
Temperaturabhängige Farbe
Temperatura de color

2 3 4
2700K 3000K 4000K

Finishing

Finitura
Finitions
Oberflächenfinish
Acabados

1 2 5
White Grey Black
Bianco Grigio Nero
Blanc Gris Noir
Weiß Grau Schwarz
Blanco Negro

Accessories

Accessori - Accessoires
Zubehör - Accesorios

AL7022

24VDC/500mA constant current converter
Convertitore 24VDC/500mA corrente costante
Convertisseur 24VDC/500mA courant constant
24VDC/500mA konstanter Strom konverter
Convertidor 24VDC/500mA corriente constante

Drivers

Alimentatori - Alimentateurs
Netzteile - Alimentadores

500 mA	on/off	dimnable
AL1074 (1.2)	30mm IP20	AL4010 (1.4)
AL1077 (1.2)	40mm IP20	AL4151 (1.4)
AL1084 (1.3)	55mm IP20 S.P.	AL4153 (1.4)
		72mm IP20 PUSH 0/1..10V
		72mm IP20 DALI 2
		56mm IP20 PUSH IGBT-TRIAC



BLACK 10

design: Lapo Grassellini

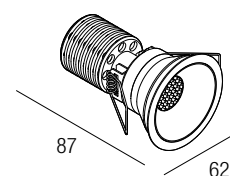

Supply current

Alimentazione
 Courant d'alimentation
 Stromversorgung
 Corriente de alimentación
250 mA (V_i 36V)

Power

Potenza
 Pouissance
 Bestuekung
 Potencia
10 W



Photometric diagrams

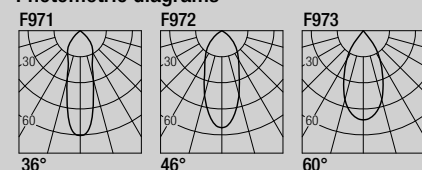

CCT/CRI/Flux

	CRI85	CRI93
2700K	890 lm	840 lm
3000K	1000 lm	930 lm
4000K	1040 lm	960 lm

CRI85 - CRI93
2-Step MacAdam

Code Construction

Costruzione del codice - Construction du code produit
 Bau der Produkt-Code - Construcción del código de producto

BK3 X X X X

Beam angle
 Apertura di fascio
 Angle de faisceau
 Strahlwinkel
 Ángulo del haz

	S	M	W
Beam angle	36°	46°	60°

CRI

	8	9
CRI	85	93

Color Temperature
 Temperatura colore
 Température couleur
 Temperaturabhängige Farbe
 Temperatura de color

	2	3	4
Color Temperature	2700K	3000K	4000K

Finishing

	1	2	5
Finitura	White	Grey	Black
Finitions	Bianco	Grigio	Nero
Oberflächenfinish	Blanc	Gris	Noir
Acabados	Weiß	Grau	Schwarz
	Blanco		Negro

Drivers

Alimentatori - Alimentateurs
 Netzteile - Alimentadores

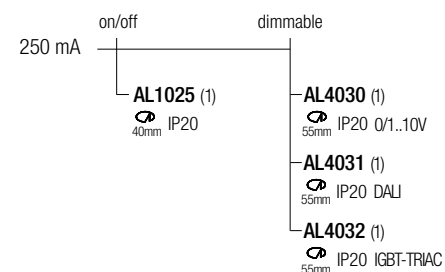

HAP 110

design: Lapo Grassellini

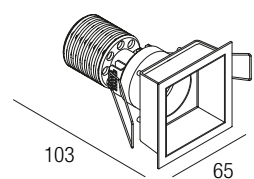

Supply current

Alimentazione
Courant d'alimentation
Stromversorgung
Corriente de alimentación
250 mA (V_i 36V)

Power

Potenza
Puissance
Bestuekung
Potencia
10 W



Photometric diagrams

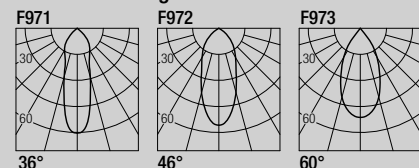

CCT/CRI/Flux

	CRI85	CRI93
2700K	890 lm	840 lm
3000K	1000 lm	930 lm
4000K	1040 lm	960 lm

CRI85 - CRI93
2-Step MacAdam

Code Construction

Costruzione del codice - Construction du code produit
Bau der Produkt-Code - Construcción del código de producto

HP11 X X X X

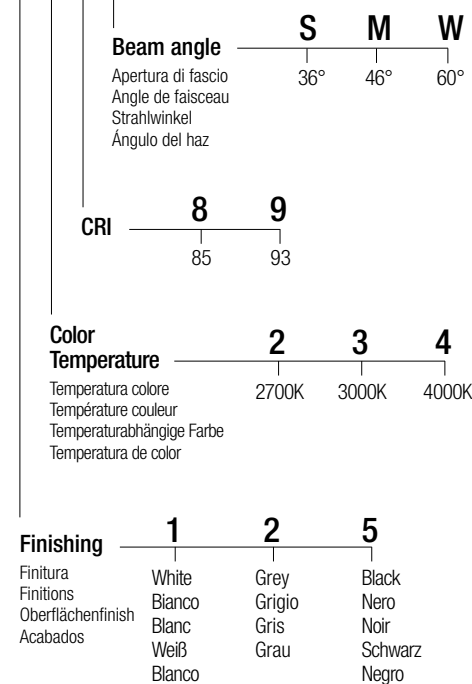

Accessories

Accessori - Accessoires
Zubehör - Accesorios

LOH1B

Black
Nero
Noir
Schwarz
Negro

Low luminance louver
Filtro antiabbagliamento
Filtre basse luminance
Geringe Leuchtdichte-Filter
Filtro de baja luminancia

SHP1101

Milky screen
Schermo opale
Écran opale
Opal-Bildschirm
Pantalla opal

Note: the screen must be ordered together with the lighting fixture - **Nota:** lo schermo deve essere ordinato congiuntamente all'apparecchio - **Note:** l'écran doit être commandé en même temps que l'appareil

Anmerkung: muss der Bildschirm zusammen mit Leuchtkörper bestellt werden - **Nota:** la pantalla debe pedirse junta con la luminaria

Drivers

Alimentatori - Alimentateurs
Netzteile - Alimentadores

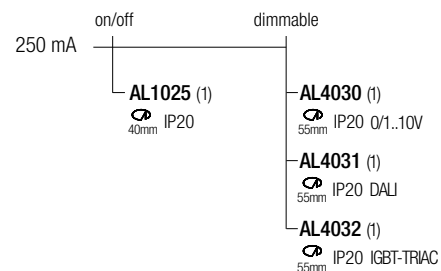

HAP 120

design: Lapo Grassellini

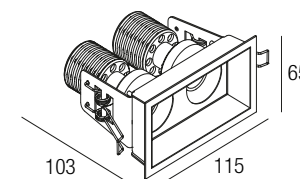

Supply current

Alimentazione
Courant d'alimentation
Stromversorgung
Corriente de alimentación
250 mA (V_i 2 x 36V)

Power

Potenza
Puissance
Bestuekung
Potencia
2 x 10 W



Photometric diagrams

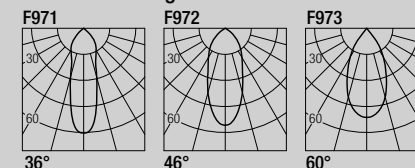

CCT/CRI/Flux

	CRI85	CRI93
2700K	2 x 890 lm	2 x 840 lm
3000K	2 x 1000 lm	2 x 930 lm
4000K	2 x 1040 lm	2 x 960 lm

CRI85 - CRI93
2-Step MacAdam

Code Construction

Costruzione del codice - Construction du code produit
Bau der Produkt-Code - Construcción del código de producto

HP12 X X X X

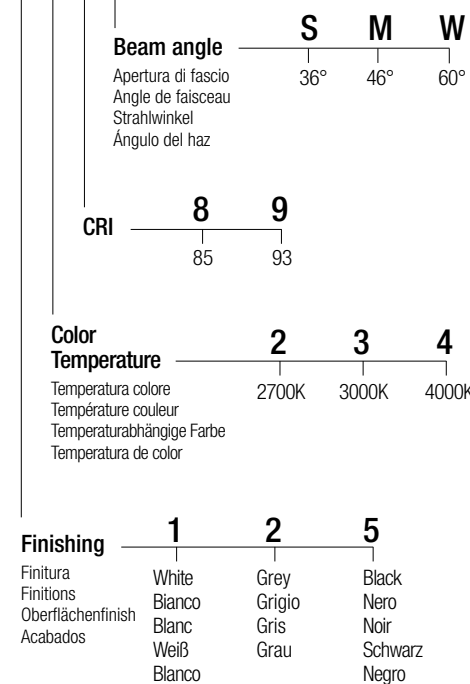

Accessories

Accessori - Accessoires
Zubehör - Accesorios

LOH1X2B

(2 pcs)
Black
Nero
Noir
Schwarz
Negro

Low luminance louver
Filtro antiabbagliamento
Filtre basse luminance
Geringe Leuchtdichte-Filter
Filtro de baja luminancia

SHP1201

(2 pcs)
Milky screen
Schermo opale
Écran opale
Opal-Bildschirm
Pantalla opal

Note: the screen must be ordered together with the lighting fixture - **Nota:** lo schermo deve essere ordinato congiuntamente all'apparecchio - **Note:** l'écran doit être commandé en même temps que l'appareil

Anmerkung: muss der Bildschirm zusammen mit Leuchtkörper bestellt werden - **Nota:** la pantalla debe pedirse junta con la luminaria

Drivers

Alimentatori - Alimentateurs
Netzteile - Alimentadores

Note: each fixture needs 2 drivers
Nota: considerare 2 alimentatori per ogni apparecchio
Note: chaque appareil nécessite 2 alimentateurs
Anmerkung: Jedes Gerät muss 2-Netzteile
Nota: cada luminaria necesita 2 alimentadores

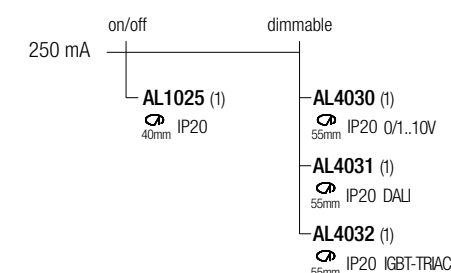

HAP 130

design: Lapo Grassellini

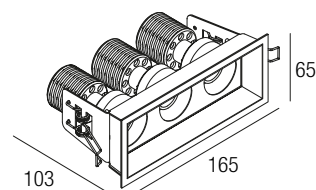

Supply current

Alimentazione
Courant d'alimentation
Stromversorgung
Corriente de alimentación
250 mA (V, 3 x 36V)

Power

Potenza
Puissance
Bestuekung
Potencia
3 x 10 W



Photometric diagrams

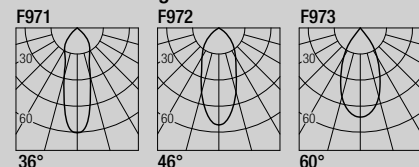

CCT/CRI/Flux

CCT	CRI85	CRI93
2700K	3 x 890 lm	3 x 840 lm
3000K	3 x 1000 lm	3 x 930 lm
4000K	3 x 1040 lm	3 x 960 lm

CRI85 - CRI93
2-Step MacAdam

Code Construction

Costruzione del codice - Construction du code produit
Bau der Produkt-Code - Construcción del código de producto

HP13 X X X X

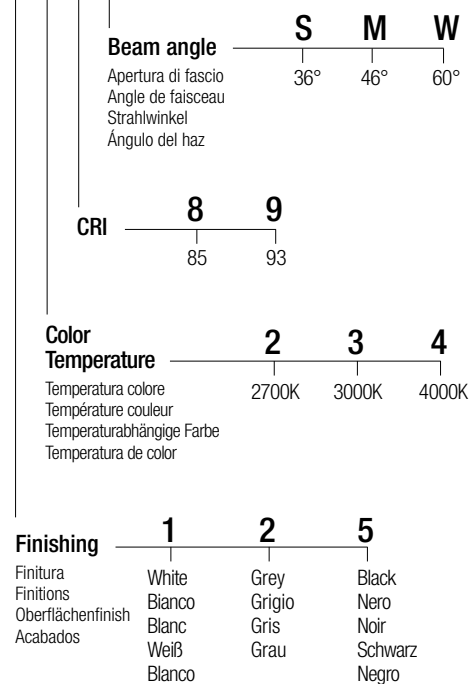

Accessories

Accessori - Accessoires
Zubehör - Accesorios

LOH1X3B

(3 pcs)
Black
Nero
Noir
Schwarz
Negro

Low luminance louver
Filtro antiabagliamento
Filtre basse luminance
Geringe Leuchtdichte-Filter
Filtro de baja luminancia

SHP1301

(3 pcs)
Milky screen
Schermo opale
Écran opale
Opal-Bildschirm
Pantalla opal

Note: the screen must be ordered together with the lighting fixture - **Nota:** lo schermo deve essere ordinato congiuntamente all'apparecchio - **Note:** l'écran doit être commandé en même temps que l'appareil

Anmerkung: muss der Bildschirm zusammen mit Leuchtkörper bestellt werden - **Nota:** la pantalla debe pedirse junta con la luminaria

Drivers

Alimentatori - Alimentateurs
Netzteile - Alimentadores

Note: each fixture needs 3 drivers
Nota: considerare 3 alimentatori per ogni apparecchio
Note: chaque appareil nécessite 3 alimentateurs
Anmerkung: Jedes Gerät muss 3-Netzteile
Nota: cada luminaria necesita 3 alimentadores

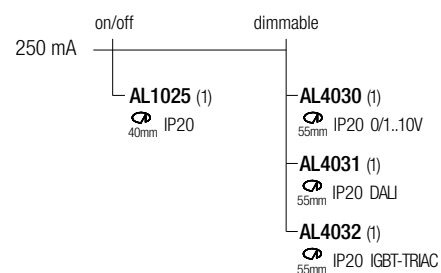

HAP 140

design: Lapo Grassellini

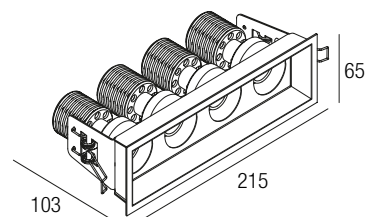

Supply current
 Alimentazione
 Courant d'alimentation
 Stromversorgung
 Corriente de alimentación
250 mA (V, 4 x 36V)

Power
 Potenza
 Pouissance
 Bestuekung
 Potencia
4 x 10 W



CCT/CRI/Flux

	CRI85	CRI93
2700K	4 x 890 lm	4 x 840 lm
3000K	4 x 1000 lm	4 x 930 lm
4000K	4 x 1040 lm	4 x 960 lm

Photometric diagrams

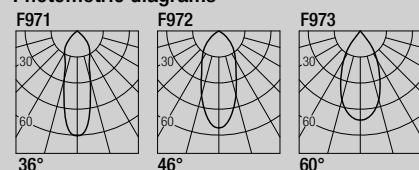

CRI85 - CRI93
2-Step MacAdam

Code Construction

Costruzione del codice - Construction du code produit
 Bau der Produkt-Code - Construcción del código de producto

HP14 X X X X

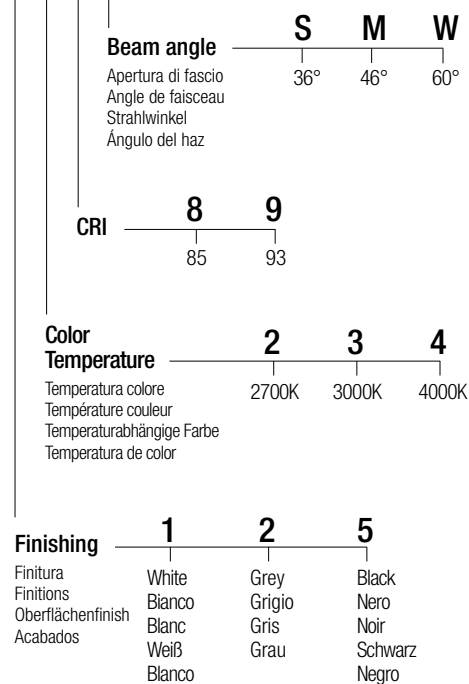

Accessories

Accessori - Accessoires
 Zubehör - Accesorios

LOH1X4B

(4 pcs)
 Black
 Nero
 Noir
 Schwarz
 Negro

Low luminance louver
 Filtro antiabbagliamento
 Filtre basse luminance
 Geringe Leuchtlichte-Filter
 Filtro de baja luminancia

SHP1401

(4 pcs)
 Milky screen
 Schermo opale
 Écran opale
 Opal-Bildschirm
 Pantalla opal

Note: the screen must be ordered together with the lighting fixture - **Nota:** lo schermo deve essere ordinato congiuntamente all'apparecchio - **Note:** l'écran doit être commandé en même temps que l'appareil
Anmerkung: muss der Bildschirm zusammen mit Leuchtkörper bestellt werden - **Nota:** la pantalla debe pedirse junta con la luminaria

Drivers

Alimentatori - Alimentateurs
 Netzteile - Alimentadores

Note: each fixture needs 4 drivers
Nota: considerare 4 alimentatori per ogni apparecchio
Note: chaque appareil nécessite 4 alimentateurs
Anmerkung: Jedes Gerät muss 4-Netzteile
Nota: cada luminaria necesita 4 alimentadores

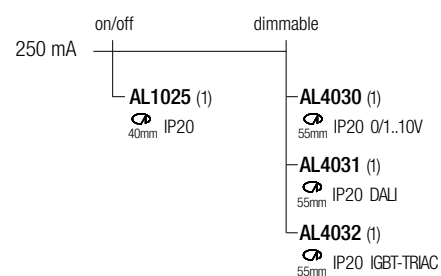

JIMBO 2

design: Roberto Mantovani

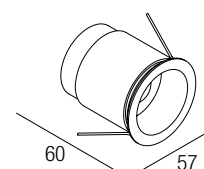

Supply current

Alimentazione
Courant d'alimentation
Stromversorgung
Corriente de alimentación

350-500 mA (V, 2,9V)

Power

Potenza
Puissance
Bestuekung
Potencia

1-2 W

Series wiring

Cablaggio in serie
Câblage en série
Verkabelung in Serie
Cableado en serie



CCT/CRI/Flux

	350mA	500mA
2700K	89 lm	128 lm
3000K	93 lm	133 lm
4200K	103 lm	154 lm
6000K	114 lm	165 lm

CRI85

2-Step MacAdam

Adjustable optics

Ottica variabile
Optique réglable
Einstellbarer Optik
Óptica ajustable

10-55°

Code Construction

Costruzione del codice - Construction du code produit
Bau der Produkt-Code - Construcción del código de producto

Accessories

Accessori - Accessoires
Zubehör - Accesorios

JBS X₁X₂

Color Temperature	0	1	2	3	6	7	8
Temperatura colore	2700K	3000K	4200K	6000K	Blue	Green	Red
Température couleur					Bleu	Vert	Rouge
Temperaturabhängige Farbe					Bleu	Grün	Rot
Temperatura de color					Azul		Rojo

Finishing	1	2	5
Finitura	White	Grey	Black
Finitions	Bianco	Grigio	Nero
Oberflächenfinish	Blanc	Gris	Noir
Acabados	Weiß	Grau	Schwarz
	Blanco		Negro

AL7022

24VDC/500mA constant current converter
Convertitore 24VDC/500mA corrente costante
Convertisseur 24VDC/500mA courant constant
24VDC/500mA konstanter Strom konverter
Convertidor 24VDC/500mA corriente constante

Drivers

Alimentatori - Alimentateurs
Netzteile - Alimentadores

350 mA		500 mA	
on/off	dimmmable	on/off	dimmmable
AL1034 (1..11) 30mm IP20	AL4000 (1..12) 72mm IP20 PUSH 0/1..10V	AL1074 (1..7) 30mm IP20	AL4010 (1..12) 72mm IP20 PUSH 0/1..10V
AL1035 (1..11) 40mm IP20	AL4051 (2..14) 72mm IP20 DALI 2	AL1077 (1..6) 40mm IP20	AL4151 (2..14) 72mm IP20 DALI 2
AL1037 (1..16) 55mm IP20 S.P.	AL4053 (1..14) 56mm IP20 PUSH IGBT-TRIAC	AL1084 (1..11) 55mm IP20 S.P.	AL4153 (1..14) 56mm IP20 PUSH IGBT-TRIAC



JIMBO 10

design: Roberto Mantovani

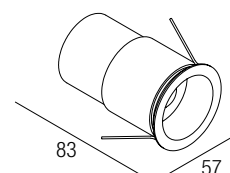

Supply current

Alimentazione
Courant d'alimentation
Stromversorgung
Corriente de alimentación
250 mA (V, 36V)

Power

Potenza
Puissance
Bestuekung
Potencia
10 W



CCT/CRI/Flux

	CRI85	CRI93
2700K	890 lm	840 lm
3000K	1000 lm	930 lm
4000K	1040 lm	960 lm

Adjustable optics

Ottica variabile
Optique réglable
Einstellbarer Optik
Óptica ajustable
10-55°

CRI85 - CRI93

2-Step MacAdam

Code Construction

Costruzione del codice - Construction du code produit
Bau der Produkt-Code - Construcción del código de producto

JBW X X X

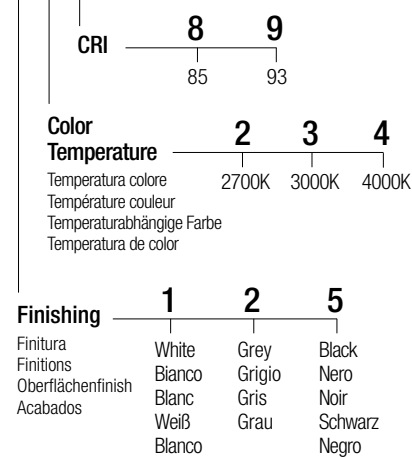

Drivers

Alimentatori - Alimentateurs
Netzteile - Alimentadores

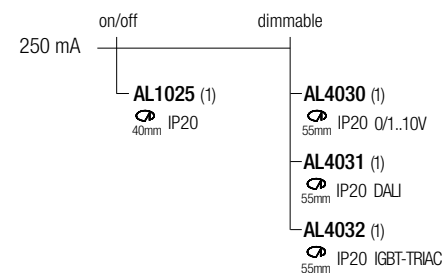

ZED

design: Roberto Mantovani

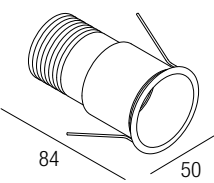

Supply current

Alimentazione
Courant d'alimentation
Stromversorgung
Corriente de alimentación
350-500 mA (V_i 2,9V)

Power

Potenza
Puissance
Bestuekung
Potencia
1-2 W

Series wiring

Cablaggio in serie
Câblage en série
Verkabelung in Serie
Cableado en serie



CCT/CRI/Flux

	350mA	500mA
2700K	89 lm	128 lm
3000K	93 lm	133 lm
4200K	103 lm	154 lm

Photometric diagrams

F445

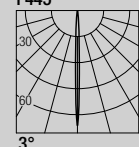

CRI85

2-Step MacAdam

Code Construction

Costruzione del codice - Construction du code produit
Bau der Produkt-Code - Construcción del código de producto

ZD X X 3

Beam angle 3°

Apertura di fascio 3°
Angle de faisceau 3°
Strahlwinkel 3°
Ángulo del haz 3°

Color Temperature 0 1 2

Temperatura colore 2700K 3000K 4200K
Température couleur
Temperaturabhängige Farbe
Temperatura de color

Finishing 1 5

Finitura White Black
Finitions Bianco Nero
Oberflächenfinish Blanc Noir
Acabados Weiß Schwarz
Blanco Negro

Drivers

Alimentatori - Alimentateurs
Netzteile - Alimentadores

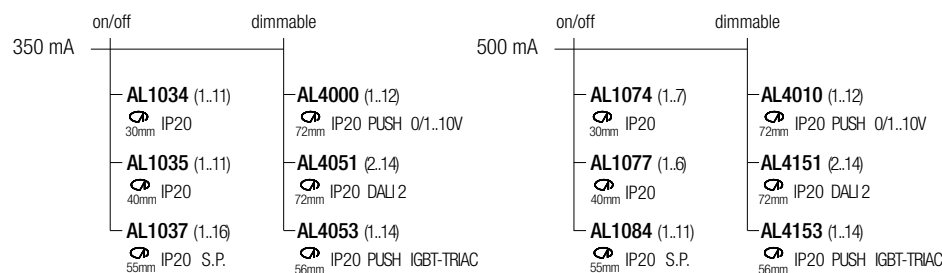

TASK 2

design: Roberto Mantovani

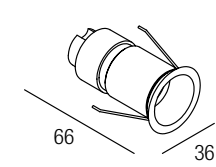

Supply current

Alimentazione
Courant d'alimentation
Stromversorgung
Corriente de alimentación
350-500 mA (V_i 2,9V)

Power

Potenza
Puissance
Bestuekung
Potencia
1-2 W

Series wiring

Cablaggio in serie
Câblage en série
Verkabelung in Serie
Cableado en serie



CCT/CRI/Flux

	350mA	500mA
2700K	89 lm	128 lm
3000K	93 lm	133 lm
4200K	103 lm	154 lm
6000K	114 lm	165 lm

Photometric diagrams

F400

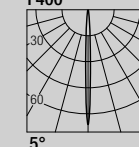

CRI85

2-Step MacAdam

Code Construction

Costruzione del codice - Construction du code produit
Bau der Produkt-Code - Construcción del código de producto

TS X X 5

Beam angle 5°

Apertura di fascio 5°
Angle de faisceau 5°
Strahlwinkel 5°
Ángulo del haz 5°

Color Temperature 0 1 2 3 6 7 8

Temperatura colore 2700K 3000K 4200K 6000K Blue Blu Verde Rosso
Température couleur Bleu Vert Rouge
Temperaturabhängige Farbe Blau Grün Rot
Temperatura de color Azul Rojo

Finishing 1 2 5

Finitura White Grey Black
Finitions Bianco Grigio Nero
Oberflächenfinish Blanc Gris Noir
Acabados Weiß Grau Schwarz
Blanco Negro

Accessories

Accessori - Accessoires
Zubehör - Accesorios

CS1006

Recessing box
Controcassa
Boîtier d'encastrement
Eingießgehäuse
Caja de empotrar

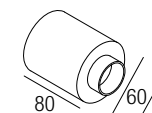

AL7022

24VDC/500mA constant current converter
Convertitore 24VDC/500mA corrente costante
Convertisseur 24VDC/500mA courant constant
24VDC/500mA konstanter Strom konverter
Convertidor 24VDC/500mA corriente constante

Drivers

Alimentatori - Alimentateurs
Netzteile - Alimentadores

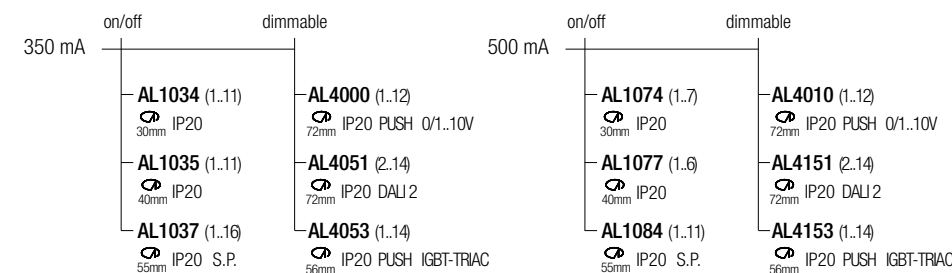

TASK 10

design: Roberto Mantovani

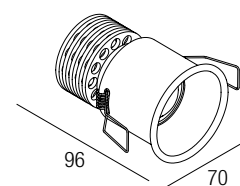

Supply current

Alimentazione
 Courant d'alimentation
 Stromversorgung
 Corriente de alimentación

250 mA (V, 36V)

Power

Potenza
 Puissance
 Bestuekung
 Potencia

10 W



Photometric diagrams

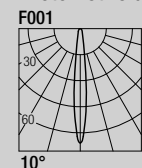

CCT/CRI/Flux

	CRI85	CRI93
2700K	890 lm	840 lm
3000K	1000 lm	930 lm
4000K	1040 lm	960 lm

CRI85 - CRI93
 2-Step MacAdam

Code Construction

Costruzione del codice - Construction du code produit
 Bau der Produkt-Code - Construcción del código de producto

TW X X X 1

Beam angle 10°

Apertura di fascio 10°
 Angle de faisceau 10°
 Strahlwinkel 10°
 Ángulo del haz 10°

CRI	8	9
	85	93

Color Temperature

	2	3	4
Temperatura colore	2700K	3000K	4000K
Température couleur			
Temperaturabhängige Farbe			
Temperatura de color			

Finishing

	1	2	5
Finitura	White	Grey	Black
Finitions	Bianco	Grigio	Nero
Oberflächenfinish	Blanc	Gris	Noir
Acabados	Weiß	Grau	Schwarz
	Blanco		Negro

Drivers

Alimentatori - Alimentateurs
 Netzteile - Alimentadores

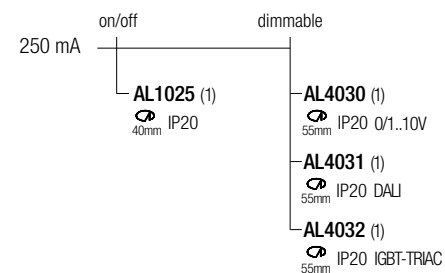

ZERINO

design: Roberto Mantovani

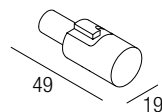

Supply current

Alimentazione
 Courant d'alimentation
 Stromversorgung
 Corriente de alimentación

250 mA (V_i 2,9V)

Power

Potenza
 Pouissance
 Bestuekung
 Potencia

0,75 W

Series wiring

Cablaggio in serie
 Câblage en série
 Verkabelung in Serie
 Cableado en serie



CCT/CRI/Flux

Photometric diagrams

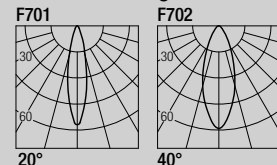

2700K	71 lm
3000K	75 lm
4200K	86 lm
6000K	91 lm

CRI85

2-Step MacAdam

Code Construction

Costruzione del codice - Construction du code produit
 Bau der Produkt-Code - Construcción del código de producto

ZK1 X X X

Color Temperature

	0	1	2	3	6	7	8
Temperatura colore	2700K	3000K	4200K	6000K	Blue	Green	Red
Température couleur					Bleu	Vert	Rouge
Temperaturabhängige Farbe					Blau	Grün	Rot
Temperatura de color					Azul		Rojo

Beam angle

	1	2
Apertura di fascio	20°	40°
Angle de faisceau		
Strahlwinkel		
Ángulo del haz		

Finishing

	1	5
Finitura	White	Black
Finitions	Bianco	Nero
Oberflächenfinish	Blanc	Noir
Acabados	Weiß	Schwarz
	Blanco	Negro

Accessories

Accessori - Accessoires
 Zubehör - Accesorios

ZQC00K ZQC00KB

White
 Bianco
 Blanc
 Weiß
 Blanco

Black
 Nero
 Noir
 Schwarz
 Negro

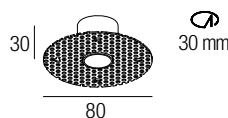

Plasterboard recessing frame
 Flangia per cartongesso
 Boîtier d'encastrement pour plaques de plâtre
 Gehäuses Trockenbau
 Cajetín para placas de yeso

Drivers

Alimentatori - Alimentateurs
 Netzteile - Alimentadores

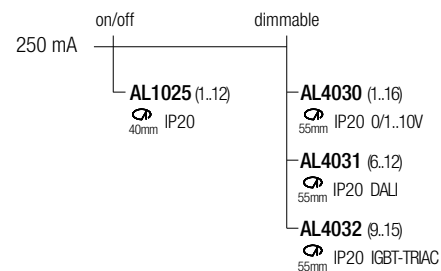

ZERO R2

design: Roberto Mantovani

[DATASHEET](#) [INSTALLATION MANUAL](#)
[CERTIFICATIONS](#) [LDT-IES](#) [DRAWINGS](#)

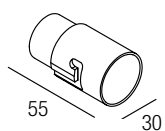

Supply current
 Alimentazione
 Courant d'alimentation
 Stromversorgung
 Corriente de alimentación
350-500 mA (V_i 2,9V)

Power
 Potenza
 Puissance
 Bestuekung
 Potencia
1-2 W

Series wiring
 Cablaggio in serie
 Câblage en série
 Verkabelung in Serie
 Cableado en serie



Photometric diagrams

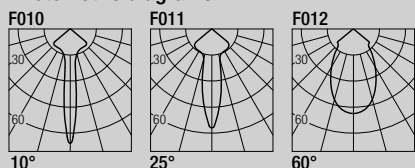

CCT/CRI/Flux

	350mA	500mA
2700K	89 lm	128 lm
3000K	93 lm	133 lm
4200K	103 lm	154 lm
6000K	114 lm	165 lm

CRI85
2-Step MacAdam

Accessories

Accessori - Accessoires
 Zubehör - Accesorios

ZQC001 ZQC001B

White Black
 Bianco Nero
 Blanc Noir
 Weiß Schwarz
 Blanco Negro

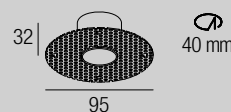

Plasterboard recessing frame
 Flangia per cartongesso
 Boîtier d'encastrement pour plaques de plâtre
 Gehäuses Trockenbau
 Cajetín para placas de yeso

AL7022

24VDC/500mA constant current converter
 Convertitore 24VDC/500mA corrente costante
 Convertisseur 24VDC/500mA courant constant
 24VDC/500mA konstanter Strom konverter
 Convertidor 24VDC/500mA corriente constante



ZERO Q2

design: Roberto Mantovani

[DATASHEET](#) [INSTALLATION MANUAL](#)
[CERTIFICATIONS](#) [LDT-IES](#) [DRAWINGS](#)

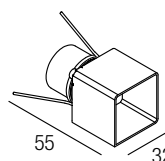

Supply current
 Alimentazione
 Courant d'alimentation
 Stromversorgung
 Corriente de alimentación
350-500 mA (V_i 2,9V)

Power
 Potenza
 Puissance
 Bestuekung
 Potencia
1-2 W

Series wiring
 Cablaggio in serie
 Câblage en série
 Verkabelung in Serie
 Cableado en serie

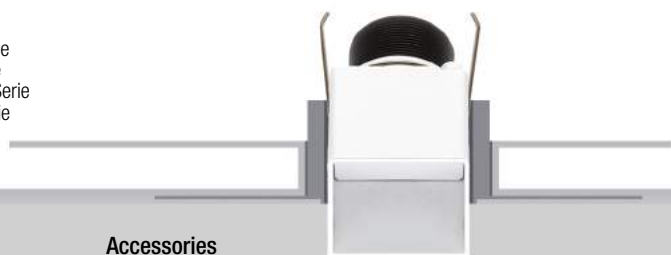

Photometric diagrams

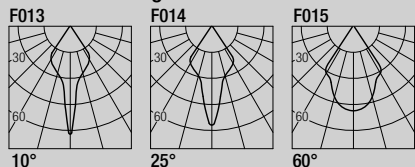

CCT/CRI/Flux

	350mA	500mA
2700K	89 lm	128 lm
3000K	93 lm	133 lm
4200K	103 lm	154 lm
6000K	114 lm	165 lm

CRI85
2-Step MacAdam

Accessories

Accessori - Accessoires
 Zubehör - Accesorios

ZQC002 ZQC002B

White Black
 Bianco Nero
 Blanc Noir
 Weiß Schwarz
 Blanco Negro

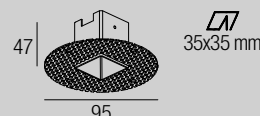

Plasterboard recessing frame
 Flangia per cartongesso
 Boîtier d'encastrement pour plaques de plâtre
 Gehäuses Trockenbau
 Cajetín para placas de yeso

AL7022

24VDC/500mA constant current converter
 Convertitore 24VDC/500mA corrente costante
 Convertisseur 24VDC/500mA courant constant
 24VDC/500mA konstanter Strom konverter
 Convertidor 24VDC/500mA corriente constante

Code Construction

Costruzione del codice - Construction du code produit
 Bau der Produkt-Code - Construcción del código de producto

ZS X X X X

Color Temperature 0 1 2 3 6 7 8
 Temperatura colore 2700K 3000K 4200K 6000K Blue Green Red
 Température couleur Blu Verde Rosso
 Temperaturabhängige Farbe Bleu Vert Rouge
 Temperatura de color Blau Grün Rot
 Azul Rojo

Beam angle 0 1 2
 Apertura di fascio 10° 25° 60°
 Angle de faisceau
 Strahlwinkel
 Ángulo del haz

Finishing 1 5
 Finitura White Black
 Finitions Bianco Nero
 Oberflächenfinish Blanc Noir
 Acabados Weiß Schwarz
 Blanco Negro

Shape 1 2
 Forma Round Square
 Forme Tondo Quadro
 Form Ronde Carré
 Runde Quadrat
 Redondo Cuadrado

Drivers

Alimentatori - Alimentateurs
 Netzteile - Alimentadores

350 mA	500 mA
<p>on/off</p> <ul style="list-style-type: none"> AL1034 (1.11) 30mm IP20 AL1035 (1.11) 40mm IP20 AL1037 (1.16) 55mm IP20 S.P. 	<p>dimmmable</p> <ul style="list-style-type: none"> AL4000 (1.12) 72mm IP20 PUSH 0/1..10V AL4051 (2.14) 72mm IP20 DALI 2 AL4053 (1.14) 56mm IP20 PUSH IGBT-TRIAC
<p>on/off</p> <ul style="list-style-type: none"> AL1074 (1.7) 30mm IP20 AL1077 (1.6) 40mm IP20 AL1084 (1.11) 55mm IP20 S.P. 	<p>dimmmable</p> <ul style="list-style-type: none"> AL4010 (1.12) 72mm IP20 PUSH 0/1..10V AL4151 (2.14) 72mm IP20 DALI 2 AL4153 (1.14) 56mm IP20 PUSH IGBT-TRIAC

ZERO R6

design: Roberto Mantovani

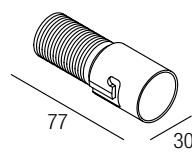

Supply current

Alimentazione
Courant d'alimentation
Stromversorgung
Corriente de alimentación
350-500 mA (V_i 8,7V)

Power

Potenza
Puissance
Bestuekung
Potencia
3-6 W

Series wiring

Cablaggio in serie
Câblage en série
Verkabelung in Serie
Cableado en serie



CCT/CRI/Flux

	350mA	500mA
2700K	267 lm	384 lm
3000K	279 lm	400 lm
4200K	309 lm	462 lm
6000K	342 lm	495 lm

CRI85

2-Step MacAdam

Photometric diagrams

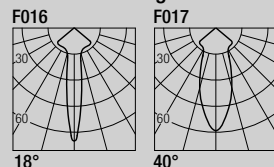

Code Construction

Costruzione del codice - Construction du code produit
Bau der Produkt-Code - Construcción del código de producto

ZW1 X X X

Color

Temperature

Temperatura colore
Température couleur
Temperaturabhängige Farbe
Temperatura de color

0	1	2	3	6	7	8
2700K	3000K	4200K	6000K	Blue	Green	Red
				Blu	Verde	Rosso
				Bleu	Vert	Rouge
				Blau	Grün	Rot
				Azul		Rojo

Beam angle

1	2
18°	40°
Apertura di fascio	
Angle de faisceau	
Strahlwinkel	
Ángulo del haz	

Finishing

1	5
White	Black
Bianco	Nero
Blanc	Noir
Weiß	Schwarz
Blanco	Negro

Drivers

Alimentatori - Alimentateurs
Netzteile - Alimentadores

350 mA		500 mA	
on/off	dimmable	on/off	dimmable
AL1034 (1..3) 30mm IP20	AL4000 (1..4) 72mm IP20 PUSH 0/1..10V	AL1074 (1..2) 30mm IP20	AL4010 (1..4) 72mm IP20 PUSH 0/1..10V
AL1035 (1..3) 40mm IP20	AL4051 (1..4) 72mm IP20 DALI 2	AL1077 (1..2) 40mm IP20	AL4151 (1..4) 72mm IP20 DALI 2
AL1037 (1..5) 55mm IP20 S.P.	AL4053 (1..4) 56mm IP20 PUSH IGBT-TRIAC	AL1084 (1..3) 55mm IP20 S.P.	AL4153 (1..4) 56mm IP20 PUSH IGBT-TRIAC

Accessories

Accessori - Accessoires
Zubehör - Accesorios

ZQC001 ZQC001B

White
Bianco
Blanc
Weiß
Blanco
Black
Nero
Noir
Schwarz
Negro

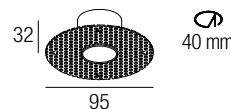

Plasterboard recessing frame
Flangia per cartongesso
Boitier d'encastrement pour plaques de plâtre
Gehäuses Trockenbau
Cajetin para placas de yeso

LZW101

Low luminance louver
Filtro antiabbagliamento
Filtre basse luminance
Geringe Leuchtdichte-Filter
Filtro de baja luminancia

SZW101

Milky screen
Schermo opale
Écran opale
Opal-Bildschirm
Pantalla opal

Note: the filter and the screen must be ordered together with the lighting fixture - **Nota:** il filtro e lo schermo devono essere ordinati congiuntamente all'apparecchio - **Note:** le filtre et l'écran doivent être commandées en même temps que l'appareil
Anmerkung: müssen der Filter und der Bildschirm zusammen mit Leuchtkörper bestellt werden
Nota: el filtro y la pantalla deben pedirse juntos con la luminaria

AL7022

24VDC/500mA constant current converter
Convertitore 24VDC/500mA corrente costante
Convertisseur 24VDC/500mA courant constant
24VDC/500mA konstanter Strom konverter
Convertidor 24VDC/500mA corriente constante



ZERO R6 EVO

design: Roberto Mantovani

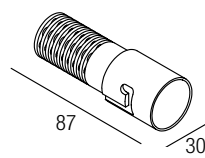
**Supply current**

Alimentazione
Courant d'alimentation
Stromversorgung
Corriente de alimentación

500 mA (V_I 9V)**Power**

Potenza
Puissance
Bestuekung
Potencia

6 W

Series wiring

Cablaggio in serie
Câblage en série
Verkabelung in Serie
Cableado en serie

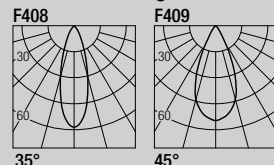

CCT/CRI/Flux

Photometric diagrams

2700K — 540 lm
3000K — 600 lm
4000K — 620 lm

CRI98

2-Step MacAdam

Code Construction

Costruzione del codice - Construction du code produit
Bau der Produkt-Code - Construcción del código de producto

ZWE1 X X X

Color Temperature — 2 — 3 — 4
Temperatura colore — 2700K — 3000K — 4000K
Température couleur
Temperaturabhängige Farbe
Temperatura de color

Beam angle — 1 — 2
Apertura di fascio — 35° — 45°
Angle de faisceau
Strahlwinkel
Ángulo del haz

Finishing — 1 — 5
Finitura — White — Black
Finitions — Bianco — Nero
Oberflächenfinish — Blanc — Noir
Acabados — Weiß — Schwarz
Blanco — Negro

Drivers

Alimentatori - Alimentateurs
Netzteile - Alimentadores

on/off	dimmable
AL1074 (1..2) 30mm IP20	AL4010 (1..4) 72mm IP20 PUSH 0/1..10V
AL1077 (1..2) 40mm IP20	AL4151 (1..4) 72mm IP20 DALI 2
AL1084 (1..3) 55mm IP20 S.P.	AL4153 (1..4) 56mm IP20 PUSH IGBT-TRIAC

Accessories

Accessori - Accessoires
Zubehör - Accesorios

ZQC001 ZQC001B

White — Black
Bianco — Nero
Blanc — Noir
Weiß — Schwarz
Blanco — Negro

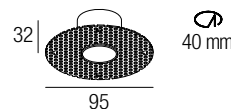

Plasterboard recessing frame
Flangia per cartongesso
Boîtier d'encastrement pour plaques de plâtre
Gehäuses Trockenbau
Cajetín para placas de yeso

LZWE101

Low luminance louver
Filtro antiabbagliamento
Filtre basse luminance
Geringe Leuchtdichte-Filter
Filtro de baja luminancia

SZWE101

Milky screen
Schermo opale
Écran opale
Opal-Bildschirm
Pantalla opal

Note: the filter and the screen must be ordered together with the lighting fixture - **Nota:** il filtro e lo schermo devono essere ordinati congiuntamente all'apparecchio - **Note:** le filtre et l'écran doivent être commandées en même temps que l'appareil
Anmerkung: müssen der Filter und der Bildschirm zusammen mit Leuchtkörper bestellt werden
Nota: el filtro y la pantalla deben pedirse juntos con la luminaria

AL7022

24VDC/500mA constant current converter
Convertitore 24VDC/500mA corrente costante
Convertisseur 24VDC/500mA courant constant
24VDC/500mA konstanter Strom konverter
Convertidor 24VDC/500mA corriente constante



ZERO Q6

design: Roberto Mantovani

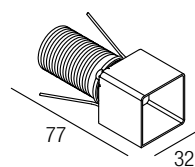

Supply current

Alimentazione
Courant d'alimentation
Stromversorgung
Corriente de alimentación
350-500 mA (V_f 8,7V)

Power

Potenza
Puissance
Bestuekung
Potencia
3-6 W

Series wiring

Cablaggio in serie
Câblage en série
Verkabelung in Serie
Cableado en serie

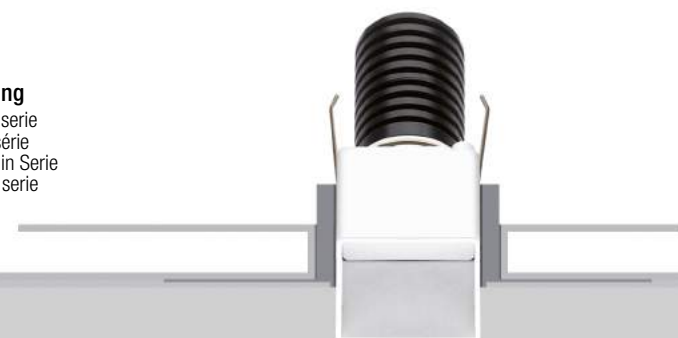

CCT/CRI/Flux

	350mA	500mA
2700K	267 lm	384 lm
3000K	279 lm	400 lm
4200K	309 lm	462 lm
6000K	342 lm	495 lm

CRI85

2-Step MacAdam

Photometric diagrams

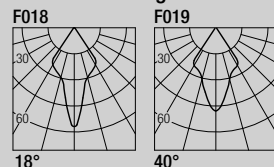

Code Construction

Costruzione del codice - Construction du code produit
Bau der Produkt-Code - Construcción del código de producto

ZW2 X X X

Color Temperature	0	1	2	3	6	7	8
Temperatura colore	2700K	3000K	4200K	6000K	Blue	Green	Red
Température couleur					Bleu	Vert	Rouge
Temperaturabhängige Farbe					Blau	Grün	Rot
Temperatura de color					Azul	Rojo	

Beam angle	1	2
Apertura di fascio	18°	40°
Angle de faisceau		
Strahlwinkel		
Ángulo del haz		

Finishing	1	5
Finitura	White	Black
Finitions	Bianco	Nero
Oberflächenfinish	Blanc	Noir
Acabados	Weiß	Schwarz
	Blanco	Negro

Accessories

Accessori - Accessoires
Zubehör - Accesorios

ZQC002 ZQC002B

White	Black	
Bianco	Nero	
Blanc	Noir	
Weiß	Schwarz	
Blanco	Negro	

Plasterboard recessing frame
Flangia per cartongesso
Boîtier d'encastrement pour plaques de plâtre
Gehäuses Trockenbau
Cajetin para placas de yeso

LZW201

Low luminance louver
Filtro antiabbagliamento
Filtre basse luminance
Geringe Leuchtdichte-Filter
Filtro de baja luminancia

SZW201

Milky screen
Schermo opale
Écran opale
Opal-Bildschirm
Pantalla opal

Note: the filter and the screen must be ordered together with the lighting fixture - **Nota:** il filtro e lo schermo devono essere ordinati congiuntamente all'apparecchio - **Note:** le filtre et l'écran doivent être commandées en même temps que l'appareil
Anmerkung: müssen der Filter und der Bildschirm zusammen mit Leuchtkörper bestellt werden
Nota: el filtro y la pantalla deben pedirse juntos con la luminaria

AL7022

24VDC/500mA constant current converter
Convertitore 24VDC/500mA corrente costante
Convertisseur 24VDC/500mA courant constant
24VDC/500mA konstanter Strom konverter
Convertidor 24VDC/500mA corriente constante

Drivers

Alimentatori - Alimentateurs
Netzteile - Alimentadores

350 mA		500 mA	
on/off	dimmable	on/off	dimmable
AL1034 (1..3) 30mm IP20	AL4000 (1..4) 72mm IP20 PUSH 0/1..10V	AL1074 (1..2) 30mm IP20	AL4010 (1..4) 72mm IP20 PUSH 0/1..10V
AL1035 (1..3) 40mm IP20	AL4051 (1..4) 72mm IP20 DALI 2	AL1077 (1..2) 40mm IP20	AL4151 (1..4) 72mm IP20 DALI 2
AL1037 (1..5) 55mm IP20 S.P.	AL4053 (1..4) 56mm IP20 PUSH IGBT-TRIAC	AL1084 (1..3) 55mm IP20 S.P.	AL4153 (1..4) 56mm IP20 PUSH IGBT-TRIAC



ZERO Q6 EVO

design: Roberto Mantovani

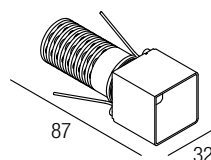

Supply current

Alimentazione
Courant d'alimentation
Stromversorgung
Corriente de alimentación

500 mA (V, 9V)

Power

Potenza
Puissance
Bestuekung
Potencia

6 W

Series wiring

Cablaggio in serie
Câblage en série
Verkabelung in Serie
Cableado en serie

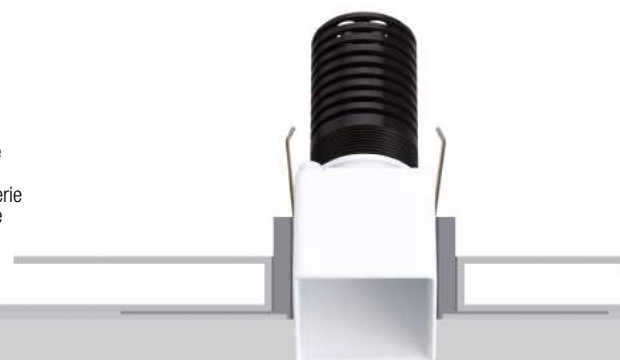

CCT/CRI/Flux

Photometric diagrams

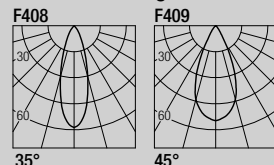

2700K — 540 lm
3000K — 600 lm
4000K — 620 lm

CRI98

2-Step MacAdam

Code Construction

Costruzione del codice - Construction du code produit
Bau der Produkt-Code - Construcción del código de producto

ZWE2 X X X

Color Temperature

2 3 4
Temperatura colore
Température couleur
Temperaturabhängige Farbe
Temperatura de color

Beam angle

1 2
Apertura di fascio
Angle de faisceau
Strahlwinkel
Ángulo del haz

Finishing

1 5
Finitura
Finitions
Oberflächenfinish
Acabados

White	Black
Bianco	Nero
Blanc	Noir
Weiß	Schwarz
Blanco	Negro

Accessories

Accessori - Accessoires
Zubehör - Accesorios

ZQC002 ZQC002B

White	Black
Bianco	Nero
Blanc	Noir
Weiß	Schwarz
Blanco	Negro

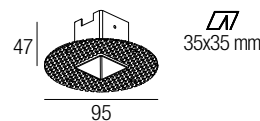

Plasterboard recessing frame
Flangia per cartongesso
Boîtier d'encastrement pour plaques de plâtre
Gehäuses Trockenbau
Cajetín para placas de yeso

LZWE201

Low luminance louver
Filtro antiabbagliamento
Filtre basse luminance
Geringe Leuchtdichte-Filter
Filtro de baja luminancia

SZWE201

Milky screen
Schermo opale
Écran opale
Opal-Bildschirm
Pantalla opal

Note: the filter and the screen must be ordered together with the lighting fixture - **Nota:** il filtro e lo schermo devono essere ordinati congiuntamente all'apparecchio - **Note:** le filtre et l'écran doivent être commandées en même temps que l'appareil
Anmerkung: müssen der Filter und der Bildschirm zusammen mit Leuchtkörper bestellt werden
Nota: el filtro y la pantalla deben pedirse juntos con la luminaria

AL7022

24VDC/500mA constant current converter
Convertitore 24VDC/500mA corrente costante
Convertisseur 24VDC/500mA courant constant
24VDC/500mA konstanter Strom konverter
Convertidor 24VDC/500mA corriente constante

Drivers

Alimentatori - Alimentateurs
Netzteile - Alimentadores

on/off	dimmable
500 mA	
AL1074 (1..2) 30mm IP20	AL4010 (1..4) 72mm IP20 PUSH 0/1..10V
AL1077 (1..2) 40mm IP20	AL4151 (1..4) 72mm IP20 DALI 2
AL1084 (1..3) 55mm IP20 S.P.	AL4153 (1..4) 56mm IP20 PUSH IGBT-TRIAC



ZERO R10

design: Roberto Mantovani

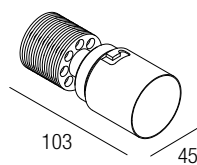

Supply current

Alimentazione
 Courant d'alimentation
 Stromversorgung
 Corriente de alimentación
500 mA (V, 18V)

Power

Potenza
 Pouissance
 Bestuekung
 Potencia
10 W

Series wiring

Cablaggio in serie
 Câblage en série
 Verkabelung in Serie
 Cableado en serie



CCT/CRI/Flux

CCT	CRI85	CRI93
2700K	890lm	840lm
3000K	1000lm	930lm
4000K	1040lm	960lm

CRI85-93

2-Step MacAdam

Photometric diagrams

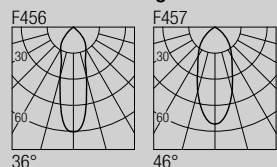

Code Construction

Costruzione del codice - Construction du code produit
 Bau der Produkt-Code - Construcción del código de producto

ZR1 X X X X

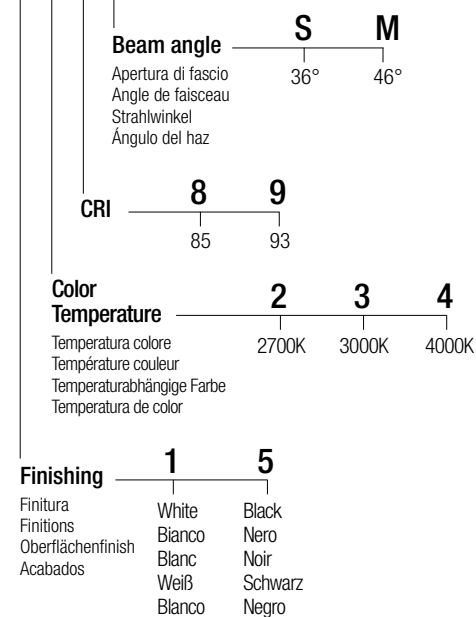

- [DATASHEET](#)
- [INSTALLATION MANUAL](#)
- [CERTIFICATIONS](#)
- [LDT-IES](#)
- [DRAWINGS](#)

Accessories

Accessori - Accessoires
 Zubehör - Accesorios

ZTC05U ZTC05UB

White
 Bianco
 Blanc
 Weiß
 Blanco

Black
 Nero
 Noir
 Schwarz
 Negro

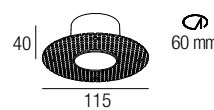

Plasterboard recessing frame
 Flangia per cartongesso
 Boîtier d'encastrement pour plaques de plâtre
 Gehäuses Trockenbau
 Cajetín para placas de yeso

LZR101

Low luminance louver
 Filtro antiabbagliamento
 Filtre basse luminance
 Geringe Leuchtdichte-Filter
 Filtro de baja luminancia

SZR101

Milky screen
 Schermo opale
 Écran opale
 Opal-Bildschirm
 Pantalla opal

Note: the filter and the screen must be ordered together with the lighting fixture - **Nota:** il filtro e lo schermo devono essere ordinati congiuntamente all'apparecchio - **Note:** le filtre et l'écran doivent être commandées en même temps que l'appareil
Anmerkung: müssen der Filter und der Bildschirm zusammen mit Leuchtkörper bestellt werden
Nota: el filtro y la pantalla deben pedirse juntos con la luminaria

AL7022

24VDC/500mA constant current converter
 Convertitore 24VDC/500mA corrente costante
 Convertisseur 24VDC/500mA courant constant
 24VDC/500mA konstanter Strom konverter
 Convertidor 24VDC/500mA corriente constante

Drivers

Alimentatori - Alimentateurs
 Netzteile - Alimentadores

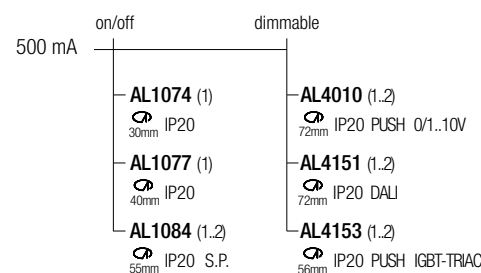

ZERO R14

design: Roberto Mantovani

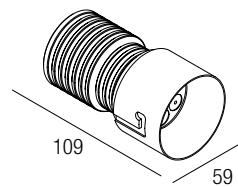

Supply current

Alimentazione
Courant d'alimentation
Stromversorgung
Corriente de alimentación

350-500 mA (V_i 20,3V)

Power

Potenza
Puissance
Bestuekung
Potencia

7-14 W

Series wiring

Cablaggio in serie
Câblage en série
Verkabelung in Serie
Cableado en serie



CCT/CRI/Flux

	350mA	500mA
2700K	623 lm	896 lm
3000K	651 lm	931 lm
4200K	721 lm	1078 lm
6000K	798 lm	1155 lm

CRI85

2-Step MacAdam

Photometric diagrams

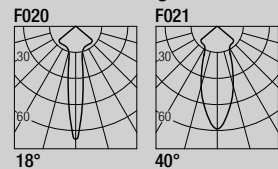

Code Construction

Costruzione del codice - Construction du code produit
Bau der Produkt-Code - Construcción del código de producto

ZZ1 X X X

Color Temperature	0	1	2	3	6	7	8
Temperatura colore	2700K	3000K	4200K	6000K	Blue	Green	Red
Température couleur					Bleu	Vert	Rouge
Temperaturabhängige Farbe					Blau	Grün	Rot
Temperatura de color					Azul	Rojo	

Beam angle	1	2
Apertura di fascio	18°	40°
Angle de faisceau		
Strahlwinkel		
Ángulo del haz		

Finishing	1	5
Finitura	White	Black
Finitions	Bianco	Nero
Oberflächenfinish	Blanc	Noir
Acabados	Weiß	Schwarz
	Blanco	Negro

Accessories

Accessori - Accessoires
Zubehör - Accesorios

ZQC003 ZQC003B

White
Bianco
Blanc
Weiß
Blanco

Black
Nero
Noir
Schwarz
Negro

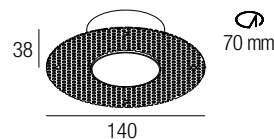

Plasterboard recessing frame
Flangia per cartongesso
Boîtier d'encastrement pour plaques de plâtre
Gehäuses Trockenbau
Cajetín para placas de yeso

LZZ101

Low luminance louver
Filtro antiabbagliamento
Filtre basse luminance
Geringe Leuchtdichte-Filter
Filtro de baja luminancia



Note: the filter must be ordered together with the lighting fixture - **Nota:** il filtro deve essere ordinato congiuntamente all'apparecchio - **Note:** le filtre doit être commandé en même temps que l'appareil - **Anmerkung:** muss der Filter zusammen mit Leuchtkörper bestellt werden
Nota: el filtro debe pedirse junto con la luminaria

Drivers

Alimentatori - Alimentateurs
Netzteile - Alimentadores

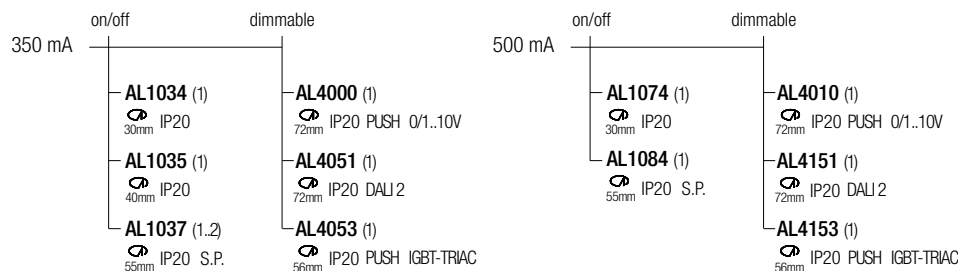

ZERO Q14

design: Roberto Mantovani

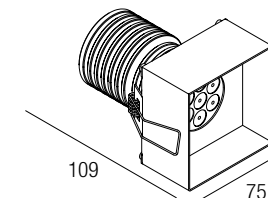

Supply current

Alimentazione
Courant d'alimentation
Stromversorgung
Corriente de alimentación

350-500 mA (V_i 20,3V)

Power

Potenza
Puissance
Bestuekung
Potencia

7-14 W

Series wiring

Cablaggio in serie
Câblage en série
Verkabelung in Serie
Cableado en serie



CCT/CRI/Flux

	350mA	500mA
2700K	623 lm	896 lm
3000K	651 lm	931 lm
4200K	721 lm	1078 lm
6000K	798 lm	1155 lm

CRI85

2-Step MacAdam

Photometric diagrams

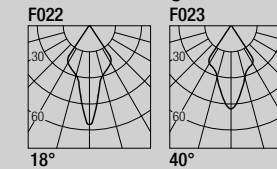

Code Construction

Costruzione del codice - Construction du code produit
Bau der Produkt-Code - Construcción del código de producto

ZZ2 X X X

Color Temperature	0	1	2	3	6	7	8
Temperatura colore	2700K	3000K	4200K	6000K	Blue	Green	Red
Température couleur					Bleu	Vert	Rouge
Temperaturabhängige Farbe					Blau	Grün	Rot
Temperatura de color					Azul	Rojo	

Beam angle	1	2
Apertura di fascio	18°	40°
Angle de faisceau		
Strahlwinkel		
Ángulo del haz		

Finishing	1	5
Finitura	White	Black
Finitions	Bianco	Nero
Oberflächenfinish	Blanc	Noir
Acabados	Weiß	Schwarz
	Blanco	Negro

Accessories

Accessori - Accessoires
Zubehör - Accesorios

ZQC004 ZQC004B

White
Bianco
Blanc
Weiß
Blanco

Black
Nero
Noir
Schwarz
Negro

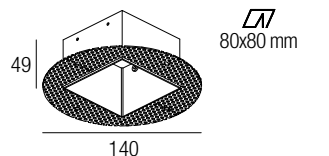

Plasterboard recessing frame
Flangia per cartongesso
Boîtier d'encastrement pour plaques de plâtre
Gehäuses Trockenbau
Cajetín para placas de yeso

LZZ201

Low luminance louver
Filtro antiabbagliamento
Filtre basse luminance
Geringe Leuchtdichte-Filter
Filtro de baja luminancia



Note: the filter must be ordered together with the lighting fixture - **Nota:** il filtro deve essere ordinato congiuntamente all'apparecchio - **Note:** le filtre doit être commandé en même temps que l'appareil - **Anmerkung:** muss der Filter zusammen mit Leuchtkörper bestellt werden
Nota: el filtro debe pedirse junto con la luminaria

Drivers

Alimentatori - Alimentateurs
Netzteile - Alimentadores

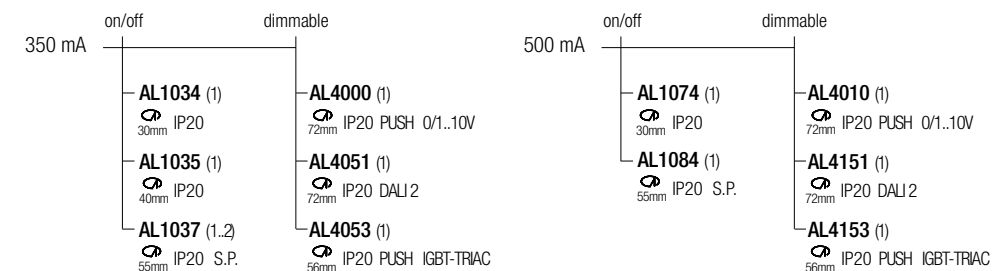

ZERO MOVE 2

design: Roberto Mantovani

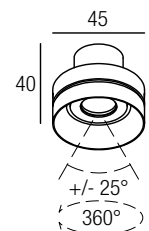

Supply current

Alimentazione
Courant d'alimentation
Stromversorgung
Corriente de alimentación

350-500 mA (V, 2,9V)

Power

Potenza
Puissance
Bestuekung
Potencia

1-2 W

Series wiring

Cablaggio in serie
Câblage en série
Verkabelung in Serie
Cableado en serie



CCT/CRI/Flux

	350mA	500mA
2700K	89 lm	128 lm
3000K	93 lm	133 lm
4200K	103 lm	154 lm
6000K	114 lm	165 lm

CRI85

2-Step MacAdam

Photometric diagrams

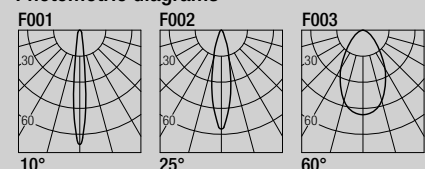

Code Construction

Costruzione del codice - Construction du code produit
Bau der Produkt-Code - Construcción del código de producto

ZSM X X X

Color Temperature	0	1	2	3	6	7	8
Temperatura colore	2700K	3000K	4200K	6000K	Blue	Green	Red
Température couleur					Blu	Verte	Rosso
Temperaturabhängige Farbe					Bleu	Vert	Rouge
Temperatura de color					Blau	Grün	Rot
					Azul		Rojo

Beam angle	0	1	2
Apertura di fascio	10°	25°	60°
Angle de faisceau			
Strahlwinkel			
Ángulo del haz			

Finishing	1	5
Finitura	White	Black
Finitions	Bianco	Nero
Oberflächenfinish	Blanc	Noir
Acabados	Weiß	Schwarz
	Blanco	Negro

Accessories

Accessori - Accessoires
Zubehör - Accesorios

ZQM001 ZQM001B

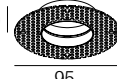
White	Black	20  55 mm
Bianco	Nero	
Blanc	Noir	
Weiß	Schwarz	
Blanco	Negro	

Plasterboard recessing frame
Flangia per cartongesso
Boîtier d'encastrement pour plaques de plâtre
Gehäuses Trockenbau
Cajetín para placas de yeso

AL7022

24VDC/500mA constant current converter
Convertitore 24VDC/500mA corrente costante
Convertisseur 24VDC/500mA courant constant
24VDC/500mA konstanter Strom konverter
Convertidor 24VDC/500mA corriente constante

Drivers

Alimentatori - Alimentateurs
Netzteile - Alimentadores

350 mA		500 mA	
on/off	dimnable	on/off	dimnable
AL1034 (1..11) 30mm IP20	AL4000 (1..12) 72mm IP20 PUSH 0/1..10V	AL1074 (1..7) 30mm IP20	AL4010 (1..12) 72mm IP20 PUSH 0/1..10V
AL1035 (1..11) 40mm IP20	AL4051 (2..14) 72mm IP20 DALI 2	AL1077 (1..6) 40mm IP20	AL4151 (2..14) 72mm IP20 DALI 2
AL1037 (1..16) 55mm IP20 S.P.	AL4053 (1..14) 55mm IP20 PUSH IGBT-TRIAC	AL1084 (1..11) 55mm IP20 S.P.	AL4153 (1..14) 55mm IP20 PUSH IGBT-TRIAC



ZERO MOVE 6

design: Roberto Mantovani

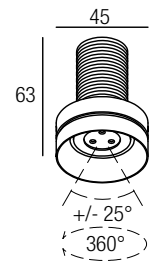

Supply current

Alimentazione
Courant d'alimentation
Stromversorgung
Corriente de alimentación

350-500 mA (V_i 8,7V)

Power

Potenza
Puissance
Bestuekung
Potencia

3-6 W

Series wiring

Cablaggio in serie
Câblage en série
Verkabelung in Serie
Cableado en serie



CCT/CRI/Flux

CCT	350mA	500mA
2700K	267 lm	384 lm
3000K	279 lm	400 lm
4200K	309 lm	462 lm
6000K	342 lm	495 lm

Photometric diagrams

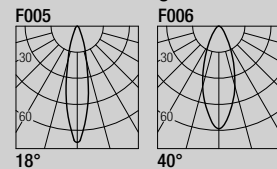

CRI85

2-Step MacAdam

Code Construction

Costruzione del codice - Construction du code produit
Bau der Produkt-Code - Construcción del código de producto

ZWM X X X

Color Temperature	0	1	2	3	6	7	8
Temperatura colore	2700K	3000K	4200K	6000K	Blue	Green	Red
Température couleur					Blu	Verte	Rosso
Temperaturabhängige Farbe					Bleu	Vert	Rouge
Temperatura de color					Blau	Grün	Rot
					Azul		Rojo

Beam angle	1	2
Apertura di fascio	18°	40°
Angle de faisceau		
Strahlwinkel		
Ángulo del haz		

Finishing	1	5
Finitura	White	Black
Finitions	Bianco	Nero
Oberflächenfinish	Blanc	Noir
Acabados	Weiß	Schwarz
	Blanco	Negro

Drivers

Alimentatori - Alimentateurs
Netzteile - Alimentadores

350 mA	on/off	dimmable	500 mA	on/off	dimmable
AL1034 (1..3)	30mm IP20	AL4000 (1..4)	72mm IP20 PUSH 0/1..10V	AL1074 (1..2)	30mm IP20
AL1035 (1..3)	40mm IP20	AL4051 (1..4)	72mm IP20 DALI 2	AL1077 (1..2)	40mm IP20
AL1037 (1..5)	55mm IP20 S.P.	AL4053 (1..4)	56mm IP20 PUSH IGBT-TRIAC	AL1084 (1..3)	55mm IP20 S.P.
				AL4101 (1..4)	72mm IP20 PUSH 0/1..10V
				AL4151 (1..4)	72mm IP20 DALI 2
				AL4153 (1..4)	56mm IP20 PUSH IGBT-TRIAC

Accessories

Accessori - Accessoires
Zubehör - Accesorios

ZQM001 ZQM001B

White	Black
Bianco	Nero
Blanc	Noir
Weiß	Schwarz
Blanco	Negro

Plasterboard recessing frame
Flangia per cartongesso
Boîtier d'encastrement pour plaques de plâtre
Gehäuses Trockenbau
Cajetín para placas de yeso

LZWM01

Low luminance louver
Filtro antiabbagliamento
Filtre basse luminance
Geringe Leuchtdichte-Filter
Filtro de baja luminancia

SZWM01

Milky screen
Schermo opale
Écran opale
Opal-Bildschirm
Pantalla opal

Note: the filter and the screen must be ordered together with the lighting fixture - **Nota:** il filtro e lo schermo devono essere ordinati congiuntamente all'apparecchio - **Note:** le filtre et l'écran doivent être commandées en même temps que l'appareil **Anmerkung:** müssen der Filter und der Bildschirm zusammen mit Leuchtkörper bestellt werden - **Nota:** el filtro y la pantalla deben pedirse juntos con la luminaria

AL7022

24VDC/500mA constant current converter
Convertitore 24VDC/500mA corrente costante
Convertisseur 24VDC/500mA courant constant
24VDC/500mA konstanter Strom konverter
Convertidor 24VDC/500mA corriente constante

ZERO MOVE 6 EVO

design: Roberto Mantovani

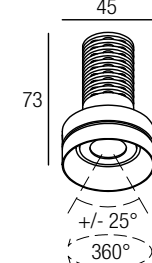

Supply current

Alimentazione
Courant d'alimentation
Stromversorgung
Corriente de alimentación

500 mA (V_i 9V)

Power

Potenza
Puissance
Bestuekung
Potencia

6 W

Series wiring

Cablaggio in serie
Câblage en série
Verkabelung in Serie
Cableado en serie



CCT/CRI/Flux

2700K	540 lm
3000K	600 lm
4000K	620 lm

Photometric diagrams

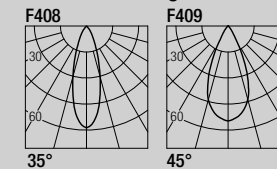

CRI98

2-Step MacAdam

Code Construction

Costruzione del codice - Construction du code produit
Bau der Produkt-Code - Construcción del código de producto

ZWEM X X X

Color Temperature	2	3	4
Temperatura colore	2700K	3000K	4000K
Température couleur			
Temperaturabhängige Farbe			
Temperatura de color			

Beam angle	1	2
Apertura di fascio	35°	45°
Angle de faisceau		
Strahlwinkel		
Ángulo del haz		

Finishing	1	5
Finitura	White	Black
Finitions	Bianco	Nero
Oberflächenfinish	Blanc	Noir
Acabados	Weiß	Schwarz
	Blanco	Negro

Accessories

Accessori - Accessoires
Zubehör - Accesorios

ZQM001 ZQM001B

White	Black
Bianco	Nero
Blanc	Noir
Weiß	Schwarz
Blanco	Negro

Plasterboard recessing frame
Flangia per cartongesso
Boîtier d'encastrement pour plaques de plâtre
Gehäuses Trockenbau
Cajetín para placas de yeso

LZWEM01

Low luminance louver
Filtro antiabbagliamento
Filtre basse luminance
Geringe Leuchtdichte-Filter
Filtro de baja luminancia

SZWEM01

Milky screen
Schermo opale
Écran opale
Opal-Bildschirm
Pantalla opal

Note: the filter and the screen must be ordered together with the lighting fixture - **Nota:** il filtro e lo schermo devono essere ordinati congiuntamente all'apparecchio - **Note:** le filtre et l'écran doivent être commandées en même temps que l'appareil **Anmerkung:** müssen der Filter und der Bildschirm zusammen mit Leuchtkörper bestellt werden - **Nota:** el filtro y la pantalla deben pedirse juntos con la luminaria

AL7022

24VDC/500mA constant current converter
Convertitore 24VDC/500mA corrente costante
Convertisseur 24VDC/500mA courant constant
24VDC/500mA konstanter Strom konverter
Convertidor 24VDC/500mA corriente constante

Drivers

Alimentatori - Alimentateurs
Netzteile - Alimentadores

500 mA	on/off	dimmable	
AL1074 (1..2)	30mm IP20	AL4010 (1..4)	72mm IP20 PUSH 0/1..10V
AL1077 (1..2)	40mm IP20	AL4151 (1..4)	72mm IP20 DALI 2
AL1084 (1..3)	55mm IP20 S.P.	AL4153 (1..4)	56mm IP20 PUSH IGBT-TRIAC
AL9051 (1..3)	44mm IP67	AL8050 (1..4)	IP67 DALI

DIDDI

design: Roberto Mantovani

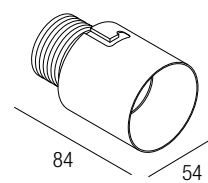

Supply current
 Alimentazione
 Courant d'alimentation
 Stromversorgung
 Corriente de alimentación
350-500 mA (V_i 2,9V)

Power
 Potenza
 Pouissance
 Bestuekung
 Potencia
1-2 W

Series wiring
 Cablaggio in serie
 Câblage en série
 Verkabelung in Serie
 Cableado en serie



Photometric diagrams

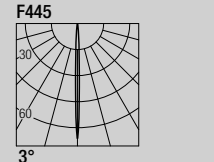

CCT/CRI/Flux

CCT	350mA	500mA
2700K	89 lm	128 lm
3000K	93 lm	133 lm
4200K	103 lm	154 lm

CRI85
2-Step MacAdam

Code Construction

Costruzione del codice - Construction du code produit
 Bau der Produkt-Code - Construcción del código de producto

DID X X 3

Beam angle 3°
 Apertura di fascio 3°
 Angle de faisceau 3°
 Strahlwinkel 3°
 Ángulo del haz 3°

Color Temperature

0	1	2
2700K	3000K	4200K

Finishing

1	5
White	Black
Bianco	Nero
Blanc	Noir
Weiß	Schwarz
Blanco	Negro

Accessories

Accessori - Accessoires
 Zubehör - Accesorios

ZTC10U ZTC10UB

White Bianco Blanc Weiß Blanco
 Black Nero Noir Schwarz Negro

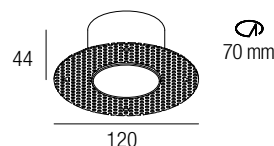

Plasterboard recessing frame
 Flangia per cartongesso
 Boîtier d'encastrement pour plaques de plâtre
 Gehäuses Trockenbau
 Cajetín para placas de yeso

LDID01

Low luminance louver
 Filtro antiabbagliamento
 Filtre basse luminance
 Geringe Leuchtdichte-Filter
 Filtro de baja luminancia



Note: the filter must be ordered together with the lighting fixture - **Nota:** il filtro deve essere ordinato congiuntamente all'apparecchio - **Note:** le filtre doit être commandé en même temps que l'appareil - **Anmerkung:** muss der Filter zusammen mit Leuchtkörper bestellt werden
Nota: el filtro debe pedirse junto con la luminaria

AL7022

24VDC/500mA constant current converter
 Convertitore 24VDC/500mA corrente costante
 Convertisseur 24VDC/500mA courant constant
 24VDC/500mA konstanter Strom konverter
 Convertidor 24VDC/500mA corriente constante

Drivers

Alimentatori - Alimentateurs
 Netzteile - Alimentadores

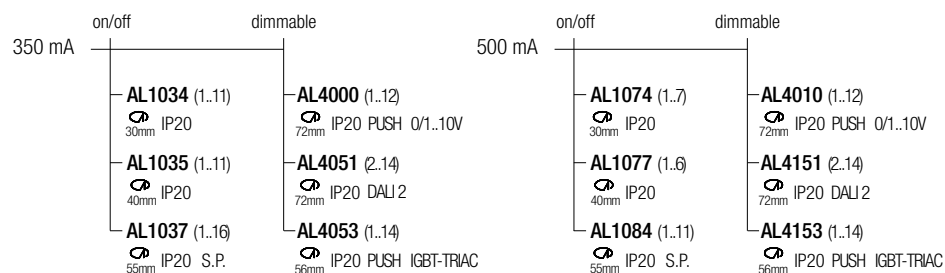

NONE R2

design: Roberto Mantovani

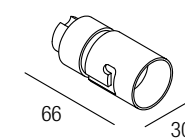

Supply current
 Alimentazione
 Courant d'alimentation
 Stromversorgung
 Corriente de alimentación
350-500 mA (V_i 2,9V)

Power
 Potenza
 Pouissance
 Bestuekung
 Potencia
1-2 W

Series wiring
 Cablaggio in serie
 Câblage en série
 Verkabelung in Serie
 Cableado en serie



Photometric diagrams

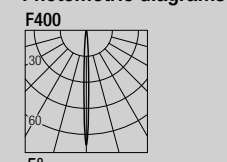

CCT/CRI/Flux

CCT	350mA	500mA
2700K	89 lm	128 lm
3000K	93 lm	133 lm
4200K	103 lm	154 lm
6000K	114 lm	165 lm

CRI85
2-Step MacAdam

Code Construction

Costruzione del codice - Construction du code produit
 Bau der Produkt-Code - Construcción del código de producto

NRS X X 5

Beam angle 5°
 Apertura di fascio 5°
 Angle de faisceau 5°
 Strahlwinkel 5°
 Ángulo del haz 5°

Color Temperature

0	1	2	3	6	7	8
2700K	3000K	4200K	6000K	Blue	Green	Red
				Blu	Verde	Rosso
				Bleu	Vert	Rouge
				Blau	Grün	Rot
				Azul		Rojo

Finishing

1	5
White	Black
Bianco	Nero
Blanc	Noir
Weiß	Schwarz
Blanco	Negro

Accessories

Accessori - Accessoires
 Zubehör - Accesorios

ZQC001 ZQC001B

White Bianco Blanc Weiß Blanco
 Black Nero Noir Schwarz Negro

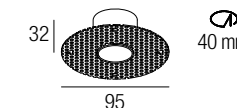

Plasterboard recessing frame
 Flangia per cartongesso
 Boîtier d'encastrement pour plaques de plâtre
 Gehäuses Trockenbau
 Cajetín para placas de yeso

AL7022

24VDC/500mA constant current converter
 Convertitore 24VDC/500mA corrente costante
 Convertisseur 24VDC/500mA courant constant
 24VDC/500mA konstanter Strom konverter
 Convertidor 24VDC/500mA corriente constante

Drivers

Alimentatori - Alimentateurs
 Netzteile - Alimentadores

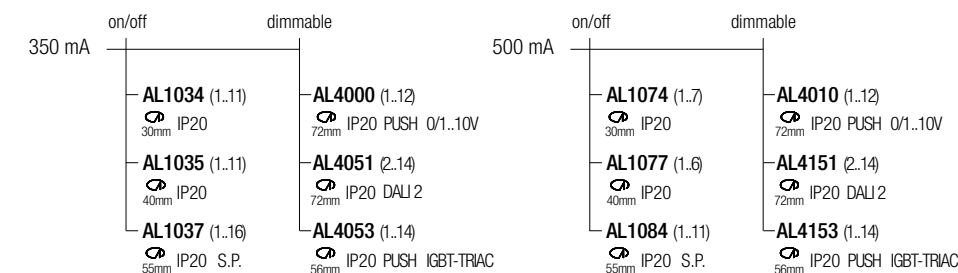

NONE R10

design: Roberto Mantovani

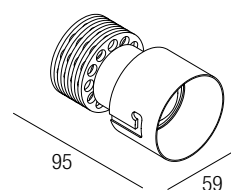

Supply current

Alimentazione
Courant d'alimentation
Stromversorgung
Corriente de alimentación

250 mA (V, 36V)

Power

Potenza
Puissance
Bestuekung
Potencia

10 W



CCT/CRI/Flux

	CRI85	CRI93
2700K	890 lm	840 lm
3000K	1000 lm	930 lm
4000K	1040 lm	960 lm

Photometric diagrams

F001

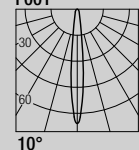

CRI85 - CRI93

2-Step MacAdam

Code Construction

Costruzione del codice - Construction du code produit
Bau der Produkt-Code - Construcción del código de producto

NRW X X X 1

Beam angle 10°

Apertura di fascio 10°
Angle de faisceau 10°
Strahlwinkel 10°
Ángulo del haz 10°

CRI	8	9
	85	93

Color Temperature	2	3	4
Temperatura colore Température couleur Temperaturabhängige Farbe Temperatura de color	2700K	3000K	4000K

Finishing	1	5
Finitura Finitions Oberflächenfinish Acabados	White Bianco Blanc Weiß Blanco	Black Nero Noir Schwarz Negro

Accessories

Accessori - Accessoires
Zubehör - Accesorios

ZQC003 ZQC003B

White
Bianco
Blanc
Weiß
Blanco

Black
Nero
Noir
Schwarz
Negro

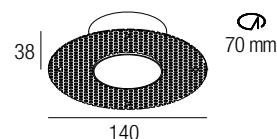

Plasterboard recessing frame
Flangia per cartongesso
Boîtier d'encastrement pour plaques de plâtre
Gehäuses Trockenbau
Cajetín para placas de yeso

Drivers

Alimentatori - Alimentateurs
Netzteile - Alimentadores

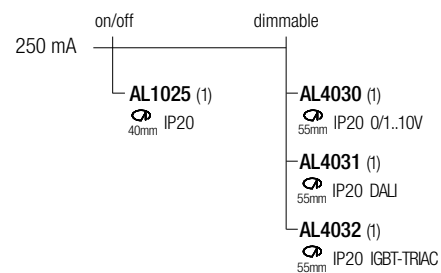

NONE Q10

design: Roberto Mantovani

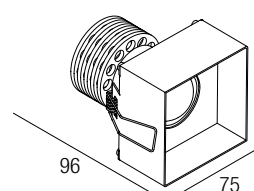

Supply current

Alimentazione
 Courant d'alimentation
 Stromversorgung
 Corriente de alimentación
250 mA (V_i 36V)

Power

Potenza
 Pouissance
 Bestuekung
 Potencia
10 W



CCT/CRI/Flux

	CRI85	CRI93
2700K	890 lm	840 lm
3000K	1000 lm	930 lm
4000K	1040 lm	960 lm

Photometric diagrams

F001

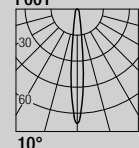

CRI85 - CRI93

2-Step MacAdam

Code Construction

Costruzione del codice - Construction du code produit
 Bau der Produkt-Code - Construcción del código de producto

NQW X X X 1

Beam angle 10°

Apertura di fascio 10°
 Angle de faisceau 10°
 Strahlwinkel 10°
 Ángulo del haz 10°

CRI	8	9
	85	93

Color Temperature	2	3	4
Temperatura colore Température couleur Temperaturabhängige Farbe Temperatura de color	2700K	3000K	4000K

Finishing	1	5
Finitura Finitions Oberflächenfinish Acabados	White Bianco Blanc Weiß Blanco	Black Nero Noir Schwarz Negro

Accessories

Accessori - Accessoires
 Zubehör - Accesorios

ZQC004 ZQC004B

White
 Bianco
 Blanc
 Weiß
 Blanco

Black
 Nero
 Noir
 Schwarz
 Negro

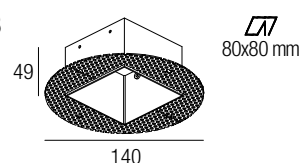

Plasterboard recessing frame
 Flangia per cartongesso
 Boîtier d'encastrement pour plaques de plâtre
 Gehäuses Trockenbau
 Cajetín para placas de yeso

Drivers

Alimentatori - Alimentateurs
 Netzteile - Alimentadores

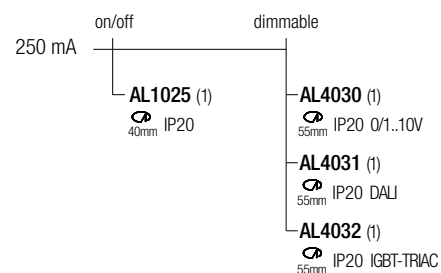

CHARLES

design: Roberto Mantovani

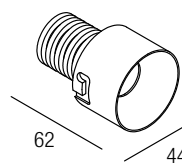

Supply current

Alimentazione
Courant d'alimentation
Stromversorgung
Corriente de alimentación

24 VDC

Power

Potenza
Puissance
Bestuekung
Potencia

2 W

Parallel wiring

Cablaggio in parallelo
Câblage en parallèle
Verkabelung in parallel
Cableado en paralelo



CCT/CRI/Flux

2700K — 128 lm
3000K — 133 lm
4200K — 154 lm

Photometric diagrams

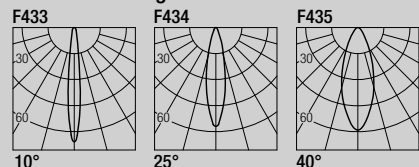

CRI85

2-Step MacAdam

Code Construction

Costruzione del codice - Construction du code produit
Bau der Produkt-Code - Construcción del código de producto

CH X X X

Color

Temperature

0 1 2

2700K 3000K 4200K
Temperatura colore
Température couleur
Temperaturabhängige Farbe
Temperatura de color

Beam angle

0 1 2

10° 25° 40°
Apertura di fascio
Angle de faisceau
Strahlwinkel
Ángulo del haz

Finishing

B N

Finitura	White	Black
Finitions	Bianco	Nero
Oberflächenfinish	Blanc	Noir
Acabados	Weiß	Schwarz
	Blanco	Negro

Accessories

Accessori - Accessoires
Zubehör - Accesorios

ZQH001 ZQH001B

White	Black
Bianco	Nero
Blanc	Noir
Weiß	Schwarz
Blanco	Negro

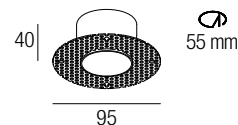

Plasterboard recessing frame
Flangia per cartongesso
Boîtier d'encastrement pour plaques de plâtre
Gehäuses Trockenbau
Cajetín para placas de yeso

LCH01

Low luminance louver
Filtro antiabbagliamento
Filtre basse luminance
Geringe Leuchtdichte-Filter
Filtro de baja luminancia

Note: the filter must be ordered together with the lighting fixture - **Nota:** il filtro deve essere ordinato congiuntamente all'apparecchio - **Note:** le filtre doit être commandé en même temps que l'appareil - **Anmerkung:** muss der Filter zusammen mit Leuchtkörper bestellt werden
Nota: el filtro debe pedirse junto con la luminaria

Drivers

Alimentatori - Alimentateurs
Netzteile - Alimentadores



Note: dimming module AL7035 to be used in combination with an on/off 24VDC power supply
Nota: modulo di dimmerazione AL7035 da utilizzare in combinazione con un alimentatore on/off 24VDC
Note: module de variation AL7035 d'intensité à utiliser en combinaison avec une alimentation on/off 24VDC
Anmerkung: Dimmmodul AL7035 zur Verwendung in Kombination mit einem on/off 24VDC-Netzteil
Nota: módulo de regulación AL7035 se utiliza en combinación con una fuente de alimentación on/off 24VDC



HOLE

design: Roberto Mantovani

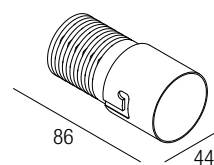

Supply current

Alimentazione
Courant d'alimentation
Stromversorgung
Corriente de alimentación

24 VDC

Power

Potenza
Puissance
Bestuekung
Potencia

7 W

Parallel wiring

Cablaggio in parallelo
Câblage en parallèle
Verkabelung in parallel
Cableado en paralelo



Photometric diagrams

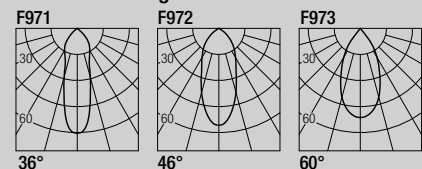

CCT/CRI/Flux

	CRI85	CRI93
2700K	630 lm	590 lm
3000K	700 lm	650 lm
4000K	730 lm	670 lm

CRI85 - CRI93

2-Step MacAdam

Code Construction

Costruzione del codice - Construction du code produit
Bau der Produkt-Code - Construcción del código de producto

HH X X X X

Beam angle	S	M	W
Apertura di fascio Angle de faisceau Strahlwinkel Ángulo del haz	36°	46°	60°
CRI	8	9	
	85	93	
Color Temperature	2	3	4
Temperatura colore Température couleur Temperaturabhängige Farbe Temperatura de color	2700K	3000K	4000K
Finishing	1	5	
Finitura Finitions Oberflächenfinish Acabados	White Bianco Blanc Weiß Blanco	Black Nero Noir Schwarz Negro	

Accessories

Accessori - Accessoires
Zubehör - Accesorios

ZQH001 ZQH001B

White
Bianco
Blanc
Weiß
Blanco

Black
Nero
Noir
Schwarz
Negro

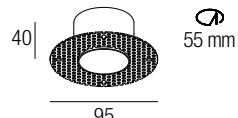

Plasterboard recessing frame
Flangia per cartongesso
Boîtier d'encastrement pour plaques de plâtre
Gehäuses Trockenbau
Cajetín para placas de yeso

Drivers

Alimentatori - Alimentateurs
Netzteile - Alimentadores

24 VDC	on/off	dimming module	dimmable
AL2012 (1..3)	IP20	AL7035	AL5012 (1..3)
60mm	PUSH DALI	IP20 PUSH DALI	45mm IP20 PUSH DALI
	Q/1..10V	Q/1..10V	Q/1..10V
AL2031 (1..10)			
70mm			
AL2040 (1..21)			
80mm			

Note: dimming module AL7035 to be used in combination with an on/off 24VDC power supply
Nota: modulo di dimmerazione AL7035 da utilizzare in combinazione con un alimentatore on/off 24VDC
Note: module de variation AL7035 d'intensité à utiliser en combinaison avec une alimentation on/off 24VDC
Anmerkung: Dimmmodul AL7035 zur Verwendung in Kombination mit einem on/off 24VDC-Netzteil
Nota: módulo de regulación AL7035 se utiliza en combinación con una fuente de alimentación on/off 24VDC



ZOE 6

design: Rod&Todd

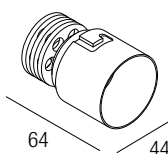

Supply current

Alimentazione
Courant d'alimentation
Stromversorgung
Corriente de alimentación

500 mA (V, 9V)

Power

Potenza
Puissance
Bestuekung
Potencia

6 W

Series wiring

Cablaggio in serie
Câblage en série
Verkabelung in Serie
Cableado en serie



CCT/CRI/Flux

2700K — 540 lm
3000K — 600 lm
4000K — 620 lm

Photometric diagrams

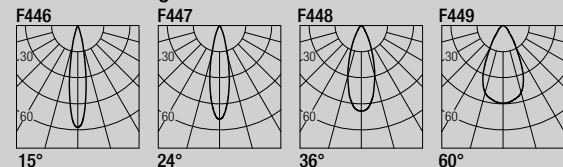

CRI98

2-Step MacAdam

Code Construction

Costruzione del codice - Construction du code produit
Bau der Produkt-Code - Construcción del código de producto

ZE6 X, X, X

Beam angle

Apertura di fascio
Angle de faisceau
Strahlwinkel
Ángulo del haz

Beam angle	N	S	M	W
	15°	24°	36°	60°

Color Temperature

Temperatura colore
Température couleur
Temperaturabhängige Farbe
Temperatura de color

Color Temperature	2	3	4
	2700K	3000K	4000K

Finishing

Finitura
Finitions
Oberflächenfinish
Acabados

Finishing	1	5
	White Bianco Blanc Weiß Blanco	Black Nero Noir Schwarz Negro

Accessories

Accessori - Accessoires
Zubehör - Accesorios

ZQH001 ZQH001B

White
Bianco
Blanc
Weiß
Blanco

Black
Nero
Noir
Schwarz
Negro

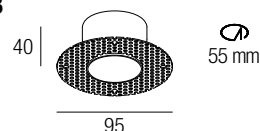

Plasterboard recessing frame
Flangia per cartongesso
Boîtier d'encastrement pour plaques de plâtre
Gehäuses Trockenbau
Cajetín para placas de yeso

LZE601

Low luminance louver
Filtro antiabbagliamento
Filtre basse luminance
Geringe Leuchtdichte-Filter
Filtro de baja luminancia

SZE601

Milky screen
Schermo opale
Écran opale
Opal-Bildschirm
Pantalla opal

Note: the filter and the screen must be ordered together with the lighting fixture - **Nota:** il filtro e lo schermo devono essere ordinati congiuntamente all'apparecchio - **Note:** le filtre et l'écran doivent être commandées en même temps que l'appareil
Anmerkung: müssen der Filter und der Bildschirm zusammen mit Leuchtkörper bestellt werden
Nota: el filtro y la pantalla deben pedirse juntos con la luminaria

AL7022

24VDC/500mA constant current converter
Convertitore 24VDC/500mA corrente costante
Convertisseur 24VDC/500mA courant constant
24VDC/500mA konstanter Strom konverter
Convertidor 24VDC/500mA corriente constante

Drivers

Alimentatori - Alimentateurs
Netzteile - Alimentadores

500 mA	on/off	dimnable
AL1074 (1..2)	30mm	IP20
AL1077 (1..2)	40mm	IP20
AL1084 (1..3)	55mm	IP20 S.P.
AL4010 (1..4)	72mm	IP20 PUSH 0/1..10V
AL4151 (1..4)	72mm	IP20 DALI 2
AL4153 (1..4)	56mm	IP20 PUSH IGBT-TRIAC



ZOE 10

design: Rod&Todd

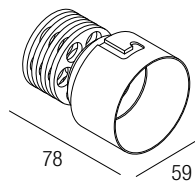

Supply current

Alimentazione
Courant d'alimentation
Stromversorgung
Corriente de alimentación
500 mA (V, 18V)

Power

Potenza
Puissance
Bestuekung
Potencia
10 W

Series wiring

Cablaggio in serie
Câblage en série
Verkabelung in Serie
Cableado en serie



Photometric diagrams

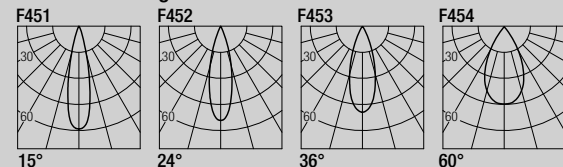

CCT/CRI/Flux

	CRI85	CRI93
2700K	890 lm	840 lm
3000K	1000 lm	930 lm
4000K	1040 lm	960 lm

CRI85 - CRI93

2-Step MacAdam

Code Construction

Costruzione del codice - Construction du code produit
Bau der Produkt-Code - Construcción del código de producto

ZE1 X X X X

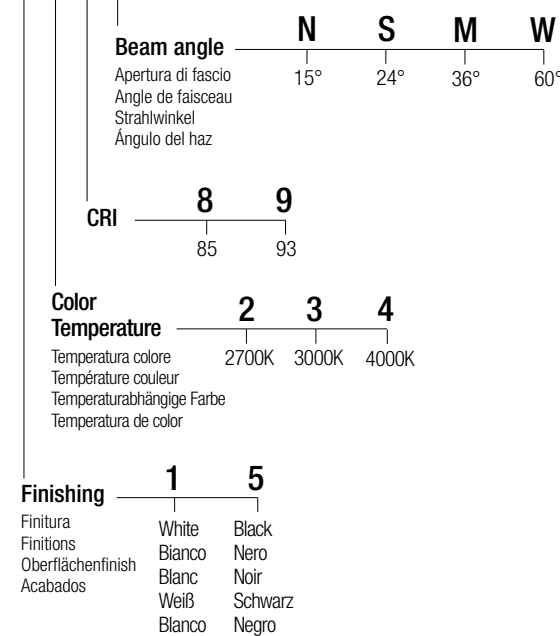

Drivers

Alimentatori - Alimentateurs
Netzteile - Alimentadores

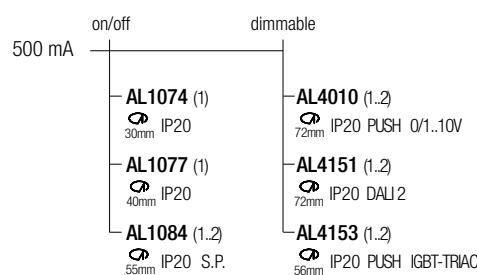

Accessories

Accessori - Accessoires
Zubehör - Accesorios

ZQC003 ZQC003B

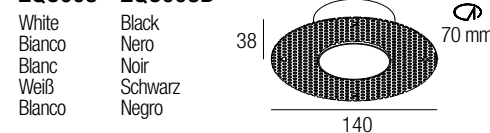

Plasterboard recessing frame
Flangia per cartongesso
Boîtier d'encastrement pour plaques de plâtre
Gehäuses Trockenbau
Cajetin para placas de yeso

LZE101

Low luminance louver
Filtro antiabbagliamento
Filtre basse luminance
Geringe Leuchtdichte-Filter
Filtro de baja luminancia

SZE101

Milky screen
Schermo opale
Écran opale
Opal-Bildschirm
Pantalla opal

Note: the filter and the screen must be ordered together with the lighting fixture - **Nota:** il filtro e lo schermo devono essere ordinati congiuntamente all'apparecchio - **Note:** le filtre et l'écran doivent être commandées en même temps que l'appareil
Anmerkung: müssen der Filter und der Bildschirm zusammen mit Leuchtkörper bestellt werden
Nota: el filtro y la pantalla deben pedirse juntos con la luminaria

AL7022

24VDC/500mA constant current converter
Convertitore 24VDC/500mA corrente costante
Convertisseur 24VDC/500mA courant constant
24VDC/500mA konstanter Strom konverter
Convertidor 24VDC/500mA corriente constante

ZOE 724

design: Rod&Todd

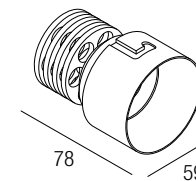

Supply current

Alimentazione
Courant d'alimentation
Stromversorgung
Corriente de alimentación
24 VDC

Power

Potenza
Puissance
Bestuekung
Potencia
7 W

Parallel wiring

Cablaggio in parallelo
Câblage en parallèle
Verkabelung in parallel
Cableado en paralelo



Photometric diagrams

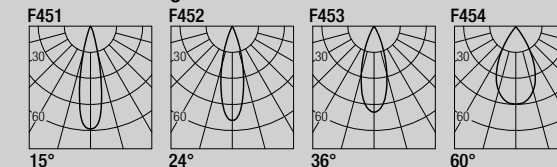

CCT/CRI/Flux

	CRI85	CRI93
2700K	630 lm	590 lm
3000K	700 lm	650 lm
4000K	730 lm	670 lm

CRI85 - CRI93

2-Step MacAdam

Code Construction

Costruzione del codice - Construction du code produit
Bau der Produkt-Code - Construcción del código de producto

ZE24 X X X X

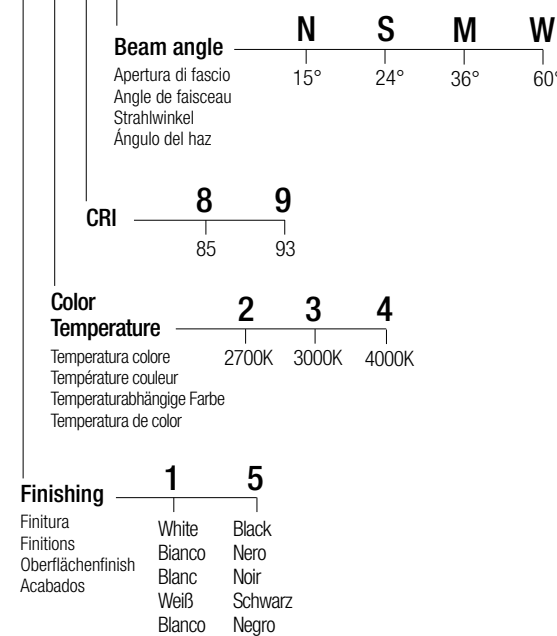

Drivers

Alimentatori - Alimentateurs
Netzteile - Alimentadores

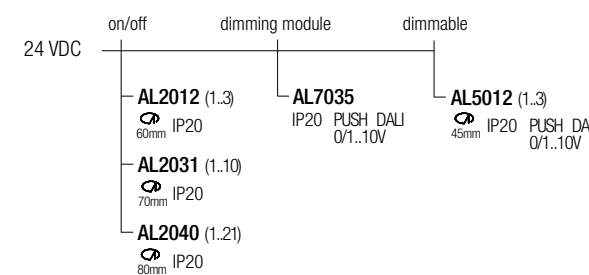

Note: dimming module AL7035 to be used in combination with an on/off 24VDC power supply
Nota: modulo di dimmerazione AL7035 da utilizzare in combinazione con un alimentatore on/off 24VDC
Note: module de variation AL7035 d'intensité à utiliser en combinaison avec une alimentation on/off 24VDC
Anmerkung: Dimmmodul AL7035 zur Verwendung in Kombination mit einem on/off 24VDC-Netzteil
Nota: módulo de regulación AL7035 se utiliza en combinación con una fuente de alimentación on/off 24VDC

Accessories

Accessori - Accessoires
Zubehör - Accesorios

ZQC003 ZQC003B

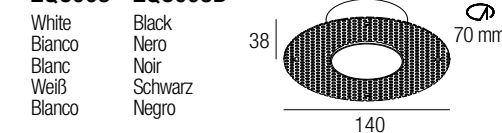

Plasterboard recessing frame
Flangia per cartongesso
Boîtier d'encastrement pour plaques de plâtre
Gehäuses Trockenbau
Cajetin para placas de yeso

LZE2401

Low luminance louver
Filtro antiabbagliamento
Filtre basse luminance
Geringe Leuchtdichte-Filter
Filtro de baja luminancia

SZE2401

Milky screen
Schermo opale
Écran opale
Opal-Bildschirm
Pantalla opal

Note: the filter and the screen must be ordered together with the lighting fixture - **Nota:** il filtro e lo schermo devono essere ordinati congiuntamente all'apparecchio - **Note:** le filtre et l'écran doivent être commandées en même temps que l'appareil
Anmerkung: müssen der Filter und der Bildschirm zusammen mit Leuchtkörper bestellt werden
Nota: el filtro y la pantalla deben pedirse juntos con la luminaria

MOON R2

design: Lapo Grassellini

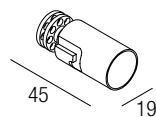

Supply current

Alimentazione
Courant d'alimentation
Stromversorgung
Corriente de alimentación

350-500 mA (V_i 2,9V)

Power

Potenza
Puissance
Bestuekung
Potencia

1-2 W

Series wiring

Cablaggio in serie
Câblage en série
Verkabelung in Serie
Cableado en serie



IP44

Photometric diagrams

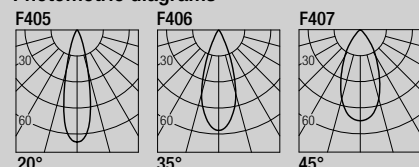

CCT/CRI/Flux

	350mA	500mA
2700K	89 lm	128 lm
3000K	93 lm	133 lm
4200K	103 lm	154 lm

CRI85

2-Step MacAdam

Code Construction

Costruzione del codice - Construction du code produit
Bau der Produkt-Code - Construcción del código de producto

MRS X X X

Beam angle

Apertura di fascio
Angle de faisceau
Strahlwinkel
Ángulo del haz

S **M** **W**
20° 35° 45°

Color Temperature

Temperatura colore
Température couleur
Temperaturabhängige Farbe
Temperatura de color

2 **3** **4**
2700K 3000K 4200K

Finishing

Finitura
Finitions
Oberflächenfinish
Acabados

1 **5**
White Black
Bianco Nero
Blanc Noir
Weiß Schwarz
Blanco Negro

Accessories

Accessori - Accessoires
Zubehör - Accesorios

ZQC00K ZQC00KB

White
Bianco
Blanc
Weiß
Blanco

Black
Nero
Noir
Schwarz
Negro

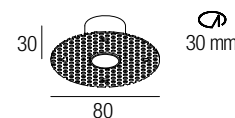

Plasterboard recessing frame
Flangia per cartongesso
Boîtier d'encastrement pour plaques de plâtre
Gehäuses Trockenbau
Cajetín para placas de yeso

AL7022

24VDC/500mA constant current converter
Convertitore 24VDC/500mA corrente costante
Convertisseur 24VDC/500mA courant constant
24VDC/500mA konstanter Strom konverter
Convertidor 24VDC/500mA corriente constante

Drivers

Alimentatori - Alimentateurs
Netzteile - Alimentadores

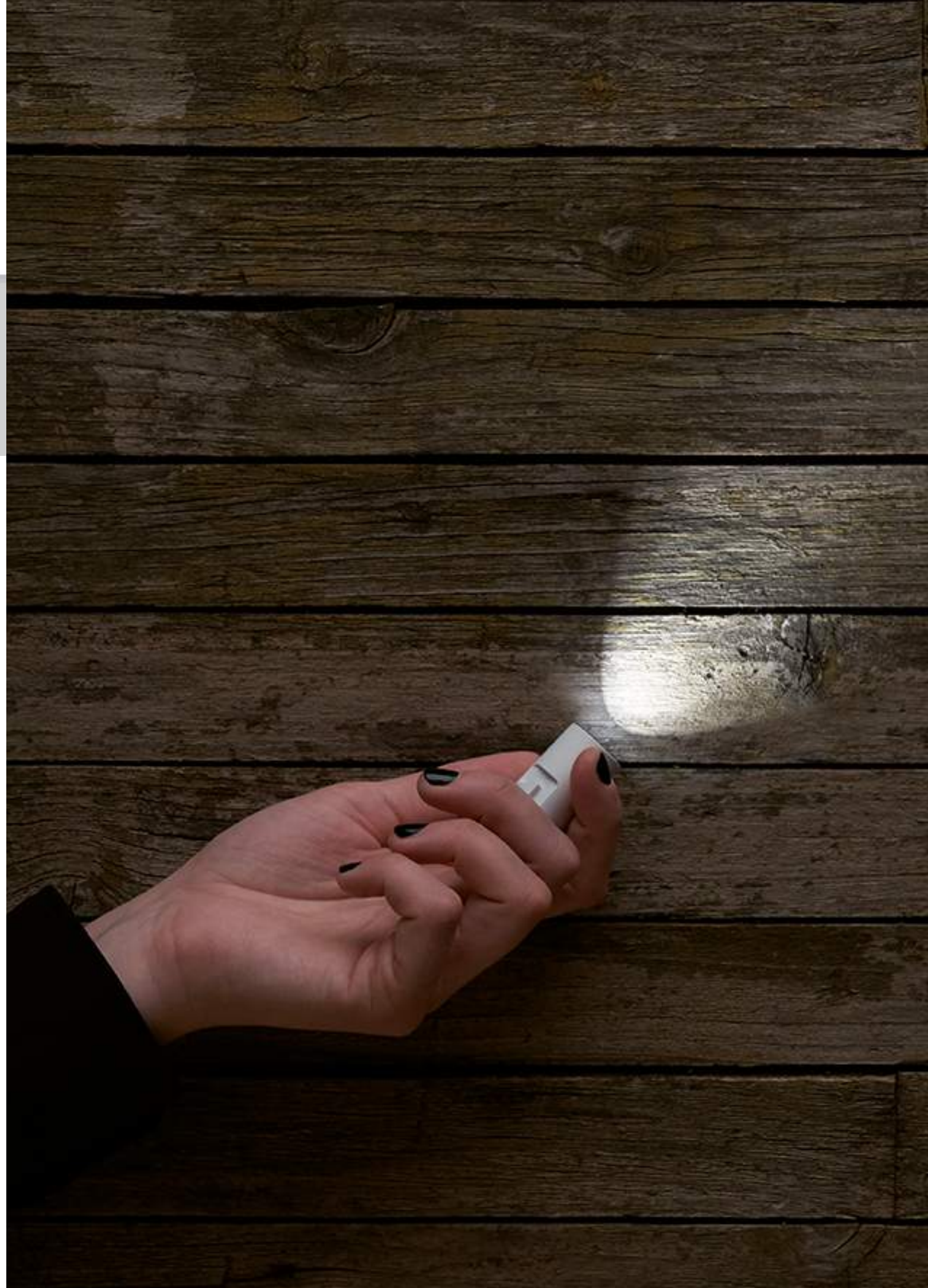
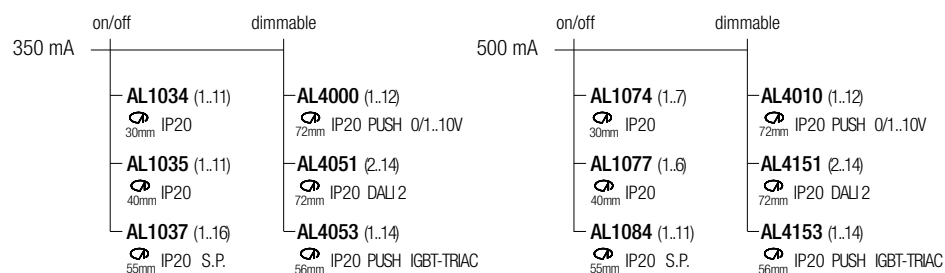

MOON R6

design: Lapo Grassellini

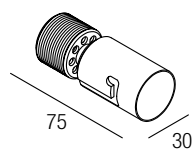

Supply current

Alimentazione
Courant d'alimentation
Stromversorgung
Corriente de alimentación
500 mA (V, 9V)

Power

Potenza
Puissance
Bestuekung
Potencia
6 W

Series wiring

Cablaggio in serie
Câblage en série
Verkabelung in Serie
Cableado en serie

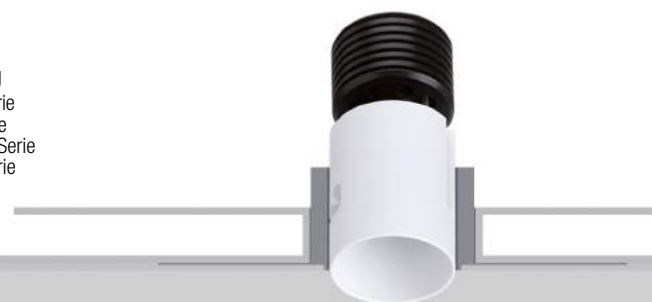

CCT/CRI/Flux

Photometric diagrams

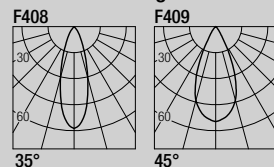

2700K — 540 lm
3000K — 600 lm
4000K — 620 lm

CRI98

2-Step MacAdam

Code Construction

Costruzione del codice - Construction du code produit
Bau der Produkt-Code - Construcción del código de producto

MRW X X X

Beam angle	S	M	
	35°	45°	
Apertura di fascio Angle de faisceau Strahlwinkel Ángulo del haz			
Color Temperature	2	3	4
	2700K	3000K	4000K
Temperatura colore Température couleur Temperaturabhängige Farbe Temperatura de color			
Finishing	1	5	
	White Bianco Blanc Weiß Blanco	Black Nero Noir Schwarz Negro	

Drivers

Alimentatori - Alimentateurs
Netzteile - Alimentadores

on/off	dimmable
500 mA	
AL1074 (1..2) 30mm IP20	AL4010 (1..4) 72mm IP20 PUSH 0/1..10V
AL1077 (1..2) 40mm IP20	AL4151 (1..4) 72mm IP20 DALI 2
AL1084 (1..3) 55mm IP20 S.P.	AL4153 (1..4) 56mm IP20 PUSH IGBT-TRIAC

Accessories

Accessori - Accessoires
Zubehör - Accesorios

ZQC001 ZQC001B

White
Bianco
Blanc
Weiß
Blanco

Black
Nero
Noir
Schwarz
Negro

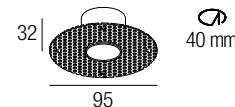

Plasterboard recessing frame
Flangia per cartongesso
Boîtier d'encastrement pour plaques de plâtre
Gehäuses Trockenbau
Cajetín para placas de yeso

SMRW01

Milky screen
Schermo opale
Écran opale
Opal-Bildschirm
Pantalla opal

Note: the screen must be ordered together with the lighting fixture - **Nota:** lo schermo deve essere ordinato congiuntamente all'apparecchio - **Note:** l'écran doit être commandé en même temps que l'appareil
Anmerkung: muss der Bildschirm zusammen mit Leuchtkörper bestellt werden - **Nota:** la pantalla debe pedirse junta con la luminaria

AL7022

24VDC/500mA constant current converter
Convertitore 24VDC/500mA corrente costante
Convertisseur 24VDC/500mA courant constant
24VDC/500mA konstanter Strom konverter
Convertidor 24VDC/500mA corriente constante

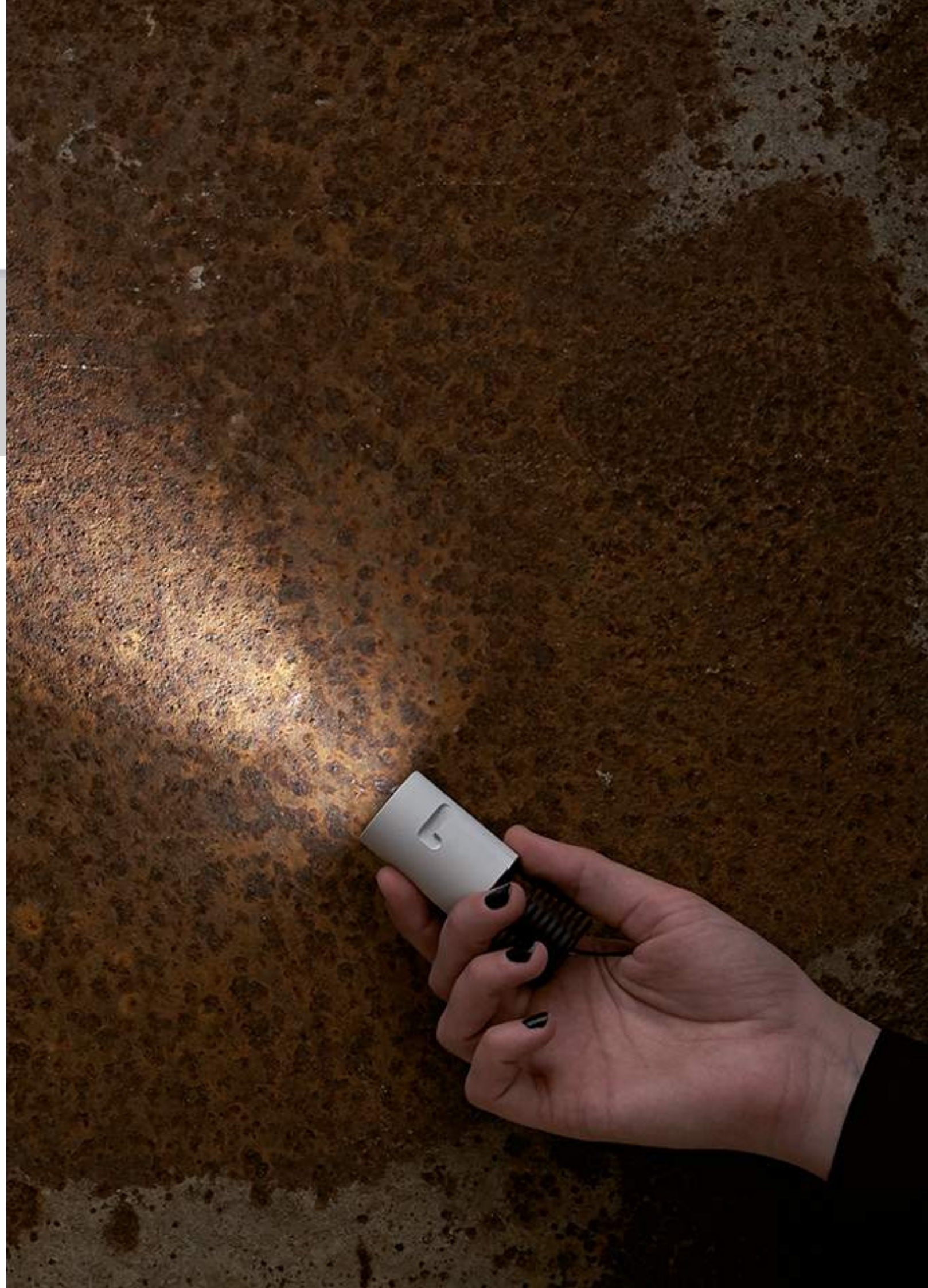

MOON R10

design: Lapo Grassellini

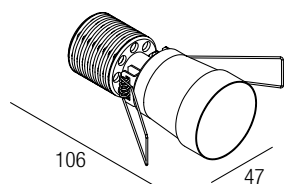
**Supply current**

Alimentazione
Courant d'alimentation
Stromversorgung
Corriente de alimentación

250 mA (V, 36V)**Power**

Potenza
Puissance
Bestuekung
Potencia

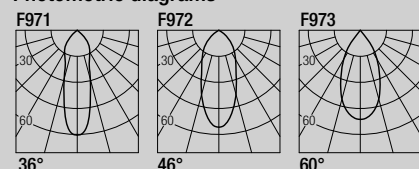
10 W**Photometric diagrams****CCT/CRI/Flux**

	CRI85	CRI93
2700K	890 lm	840 lm
3000K	1000 lm	930 lm
4000K	1040 lm	960 lm

CRI85 - CRI93**2-Step MacAdam****Code Construction**

Costruzione del codice - Construction du code produit
Bau der Produkt-Code - Construcción del código de producto

MR1 X X X X

	S	M	W
Beam angle	36°	46°	60°
Apertura di fascio Angle de faisceau Strahlwinkel Ángulo del haz			
CRI	8	9	
	85	93	
Color Temperature	2	3	4
Temperatura colore Température couleur Temperaturabhängige Farbe Temperatura de color	2700K	3000K	4000K
Finishing	1	5	
Finitura Finitions Oberflächenfinish Acabados	White Bianco Blanc Weiß Blanco	Black Nero Noir Schwarz Negro	

Drivers

Alimentatori - Alimentateurs
Netzteile - Alimentadores

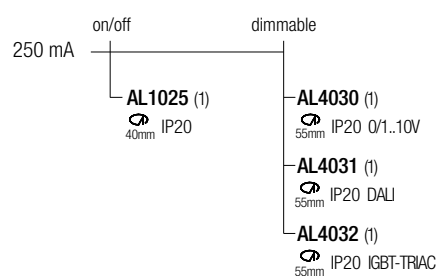
**Accessories**

Accessori - Accessoires
Zubehör - Accesorios

MQC001 MQC001B

White
Bianco
Blanc
Weiß
Blanco

Black
Nero
Noir
Schwarz
Negro

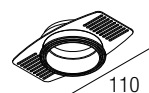

60 mm

Plasterboard recessing frame
Flangia per cartongesso
Boîtier d'encastrement pour plaques de plâtre
Gehäuses Trockenbau
Cajetín para placas de yeso

LOH1 LOH1B

White
Bianco
Blanc
Weiß
Blanco

Black
Nero
Noir
Schwarz
Negro

Low luminance louver
Filtro antiabbagliamento
Filtre basse luminance
Geringe Leuchtdichte-Filter
Filtro de baja luminancia

SMR101

Milky screen
Schermo opale
Écran opale
Opal-Bildschirm
Pantalla opal

Note: the screen must be ordered together with the lighting fixture - **Nota:** lo schermo deve essere ordinato congiuntamente all'apparecchio - **Note:** l'écran doit être commandé en même temps que l'appareil
Anmerkung: muss der Bildschirm zusammen mit Leuchtkörper bestellt werden - **Nota:** la pantalla debe pedirse junta con la luminaria



MOON Q10

design: Lapo Grassellini

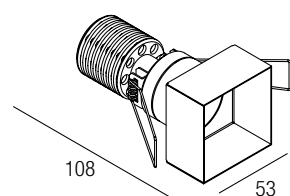

Supply current
 Alimentazione
 Courant d'alimentation
 Stromversorgung
 Corriente de alimentación
250 mA (V_i 36V)

Power
 Potenza
 Puissance
 Bestuekung
 Potencia
10 W



CCT/CRI/Flux

	CRI85	CRI93
2700K	890 lm	840 lm
3000K	1000 lm	930 lm
4000K	1040 lm	960 lm

Photometric diagrams

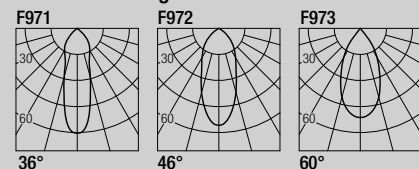

CRI85 - CRI93
2-Step MacAdam

Code Construction

Costruzione del codice - Construction du code produit
 Bau der Produkt-Code - Construcción del código de producto

MQ1 X X X X

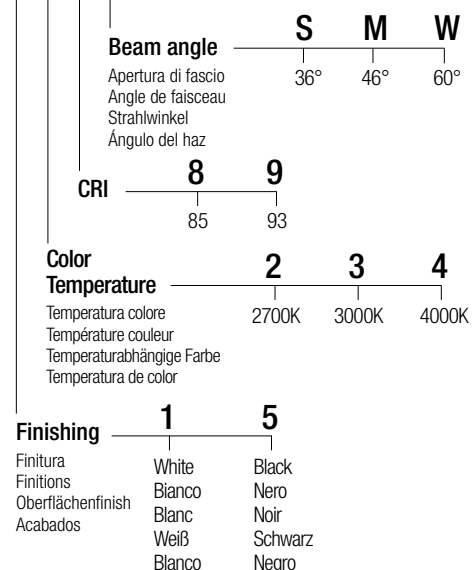

Accessories

Accessori - Accessoires
 Zubehör - Accesorios

MQC002 MQC002B

White Bianco
 Nero Nero
 Noir Noir
 Weiß Schwarz
 Blanco Negro

Plasterboard recessing frame
 Flangia per cartongesso
 Boîtier d'encastrement pour plaques de plâtre
 Gehäuses Trockenbau
 Cajetín para placas de yeso

LOH1 LOH1B

White Bianco
 Nero Nero
 Noir Noir
 Weiß Schwarz
 Blanco Negro

Low luminance louver
 Filtro antiabbagliamento
 Filtre basse luminance
 Geringe Leuchtdichte-Filter
 Filtro de baja luminancia

SMQ101

Milky screen
 Schermo opale
 Écran opale
 Opal-Bildschirm
 Pantalla opal

Note: the screen must be ordered together with the lighting fixture - **Nota:** lo schermo deve essere ordinato congiuntamente all'apparecchio - **Note:** l'écran doit être commandé en même temps que l'appareil
Anmerkung: muss der Bildschirm zusammen mit Leuchtkörper bestellt werden - **Nota:** la pantalla debe pedirse junta con la luminaria

Drivers

Alimentatori - Alimentateurs
 Netzteile - Alimentadores

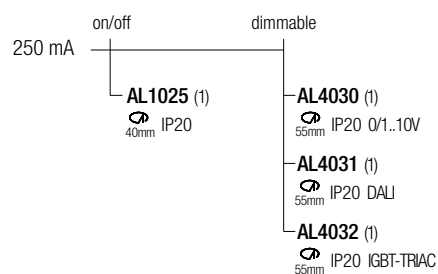

MOON QX120

design: Lapo Grassellini

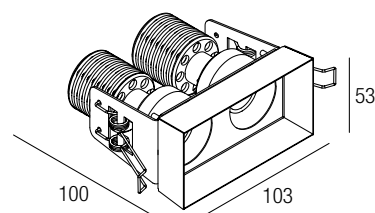
**Supply current**

Alimentazione
Courant d'alimentation
Stromversorgung
Corriente de alimentación
250 mA (V_f 2 x 36V)

Power

Potenza
Puissance
Bestuekung
Potencia
2 x 10 W

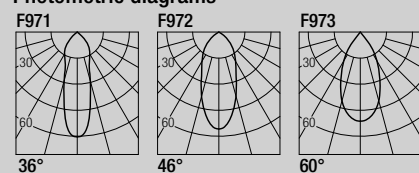
**Photometric diagrams****CCT/CRI/Flux**

	CRI85	CRI93
2700K	2 x 890 lm	2 x 840 lm
3000K	2 x 1000 lm	2 x 930 lm
4000K	2 x 1040 lm	2 x 960 lm

CRI85 - CRI93
2-Step MacAdam

Code Construction

Costruzione del codice - Construction du code produit
Bau der Produkt-Code - Construcción del código de producto

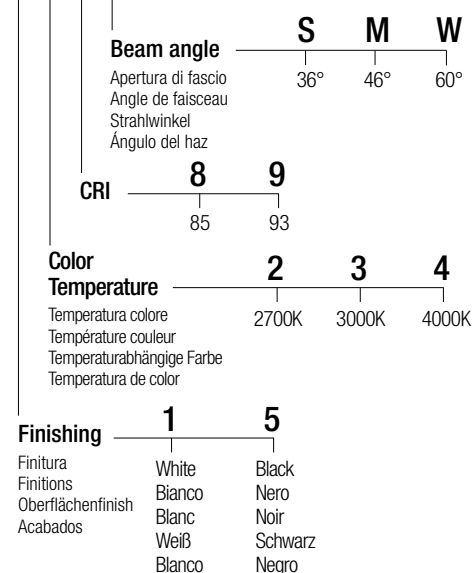
MQX12 X X X X**Drivers**

Alimentatori - Alimentateurs
Netzteile - Alimentadores

Note: each fixture needs 2 drivers

Nota: considerare 2 alimentatori per ogni apparecchio

Note: chaque appareil nécessite 2 alimentateurs

Anmerkung: Jedes Gerät muss 2-Netzteile

Nota: cada luminaria necesita 2 alimentadores

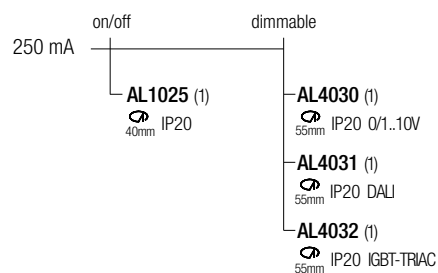

MOON QX130

design: Lapo Grassellini

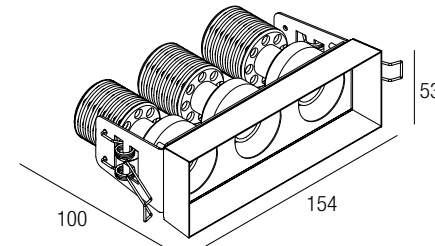
**Supply current**

Alimentazione
Courant d'alimentation
Stromversorgung
Corriente de alimentación
250 mA (V_f 3 x 36V)

Power

Potenza
Puissance
Bestuekung
Potencia
3 x 10 W

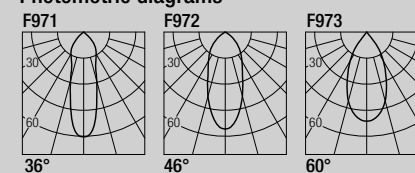
**Photometric diagrams****CCT/CRI/Flux**

	CRI85	CRI93
2700K	3 x 890 lm	3 x 840 lm
3000K	3 x 1000 lm	3 x 930 lm
4000K	3 x 1040 lm	3 x 960 lm

CRI85 - CRI93
2-Step MacAdam

Code Construction

Costruzione del codice - Construction du code produit
Bau der Produkt-Code - Construcción del código de producto

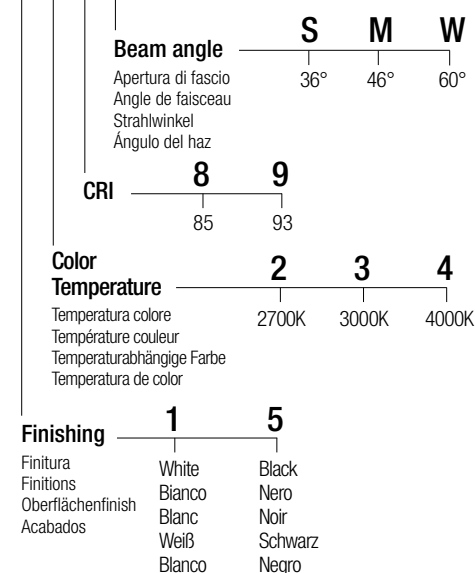
MQX13 X X X X**Drivers**

Alimentatori - Alimentateurs
Netzteile - Alimentadores

Note: each fixture needs 3 drivers

Nota: considerare 3 alimentatori per ogni apparecchio

Note: chaque appareil nécessite 3 alimentateurs

Anmerkung: Jedes Gerät muss 3-Netzteile

Nota: cada luminaria necesita 3 alimentadores

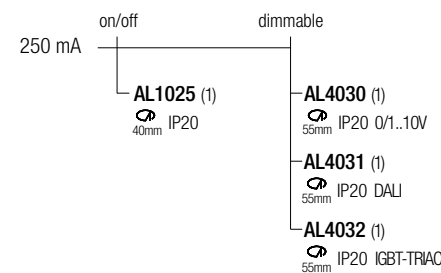
**Accessories**

Accessori - Accessoires
Zubehör - Accesorios

MQX12Q MQX12QB

White Black
Bianco Nero
Blanc Noir
Weiß Schwarz
Blanco Negro

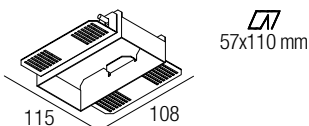

Plasterboard recessing frame
Flangia per cartongesso
Boîtier d'encastrement pour plaques de plâtre
Gehäuses Trockenbau
Cajetín para placas de yeso

LOH1X2 LOH1X2B

(2 pcs) (2 pcs)
White Black
Bianco Nero
Blanc Noir
Weiß Schwarz
Blanco Negro

Low luminance louver
Filtro antiabbagliamento
Filtre basse luminance
Geringe Leuchtdichte-Filter
Filtro de baja luminancia

SMQX1201

(2 pcs)
Milky screen
Schermo opale
Écran opale
Opal-Bildschirm
Pantalla opal

Note: the screen must be ordered together with the lighting fixture - **Nota:** lo schermo deve essere ordinato congiuntamente all'apparecchio - **Note:** l'écran doit être commandé en même temps que l'appareil

Anmerkung: muss der Bildschirm zusammen mit Leuchtörper bestellt werden - **Nota:** la pantalla debe pedirse junta con la luminaria

Accessories

Accessori - Accessoires
Zubehör - Accesorios

MQX13Q MQX13QB

White Black
Bianco Nero
Blanc Noir
Weiß Schwarz
Blanco Negro

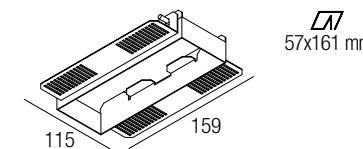

Plasterboard recessing frame
Flangia per cartongesso
Boîtier d'encastrement pour plaques de plâtre
Gehäuses Trockenbau
Cajetín para placas de yeso

LOH1X3 LOH1X3B

(3 pcs) (3 pcs)
White Black
Bianco Nero
Blanc Noir
Weiß Schwarz
Blanco Negro

Low luminance louver
Filtro antiabbagliamento
Filtre basse luminance
Geringe Leuchtdichte-Filter
Filtro de baja luminancia

SMQX1301

(3 pcs)
Milky screen
Schermo opale
Écran opale
Opal-Bildschirm
Pantalla opal

Note: the screen must be ordered together with the lighting fixture - **Nota:** lo schermo deve essere ordinato congiuntamente all'apparecchio - **Note:** l'écran doit être commandé en même temps que l'appareil

Anmerkung: muss der Bildschirm zusammen mit Leuchtkörper bestellt werden - **Nota:** la pantalla debe pedirse junta con la luminaria

MOON R20

design: Lapo Grassellini

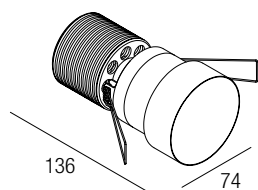

Supply current

Alimentazione
Courant d'alimentation
Stromversorgung
Corriente de alimentación
500 mA (V_f 36V)

Power

Potenza
Puissance
Bestuekung
Potencia
20 W



Photometric diagrams

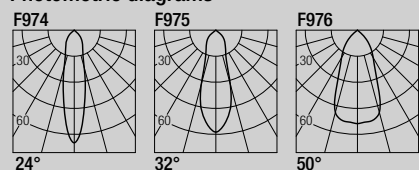

CCT/CRI/Flux

	CRI85	CRI93
2700K	1830 lm	1700 lm
3000K	2000 lm	1830 lm
4000K	2100 lm	1950 lm

CRI85 - CRI93
2-Step MacAdam

Code Construction

Costruzione del codice - Construction du code produit
Bau der Produkt-Code - Construcción del código de producto

MR2 X X X X

	S	M	W
Beam angle Apertura di fascio Angle de faisceau Strahlwinkel Ángulo del haz	24°	32°	50°
CRI	85	93	
Color Temperature Temperatura colore Température couleur Temperaturabhängige Farbe Temperatura de color	2700K	3000K	4000K
Finishing	1	5	
Finitura Finitions Oberflächenfinish Acabados	White Bianco Blanc Weiß Blanco	Black Nero Noir Schwarz Negro	

Drivers

Alimentatori - Alimentateurs
Netzteile - Alimentadores

500 mA	on/off	dimmable
AL1084 (1)	55mm	IP20 S.P.
AL4010 (1)	72mm	IP20 PUSH 0/1..10V
AL4151 (1)	72mm	IP20 DALI 2
AL4153 (1)	55mm	IP20 PUSH IGBT-TRIAC

Accessories

Accessori - Accessoires
Zubehör - Accesorios

MQC003 MQC003B

White
Bianco
Blanc
Weiß
Blanco

Black
Nero
Noir
Schwarz
Negro

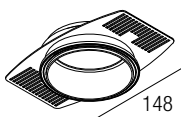

90 mm

Plasterboard recessing frame
Flangia per cartongesso
Boîtier d'encastrement pour plaques de plâtre
Gehäuses Trockenbau
Cajetín para placas de yeso

LOH2 LOH2B

White
Bianco
Blanc
Weiß
Blanco

Black
Nero
Noir
Schwarz
Negro



Low luminance louver
Filtro antiabbagliamento
Filtre basse luminance
Geringe Leuchtdichte-Filter
Filtro de baja luminancia

SMR201

Milky screen
Schermo opale
Écran opale
Opal-Bildschirm
Pantalla opal

Note: the screen must be ordered together with the lighting fixture - **Nota:** lo schermo deve essere ordinato congiuntamente all'apparecchio - **Note:** l'écran doit être commandé en même temps que l'appareil
Anmerkung: muss der Bildschirm zusammen mit Leuchtkörper bestellt werden - **Nota:** la pantalla debe pedirse junta con la luminaria



MOON Q20

design: Lapo Grassellini

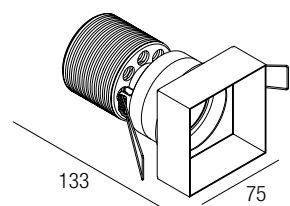

Supply current
 Alimentazione
 Courant d'alimentation
 Stromversorgung
 Corriente de alimentación
500 mA (V, 36V)

Power
 Potenza
 Pouissance
 Bestuekung
 Potencia
20 W



CCT/CRI/Flux

CCT	CRI85	CRI93
2700K	1830 lm	1700 lm
3000K	2000 lm	1830 lm
4000K	2100 lm	1950 lm

Photometric diagrams

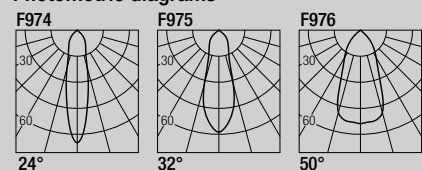

CRI85 - CRI93
2-Step MacAdam

Code Construction

Costruzione del codice - Construction du code produit
 Bau der Produkt-Code - Construcción del código de producto

MQ2 X X X X

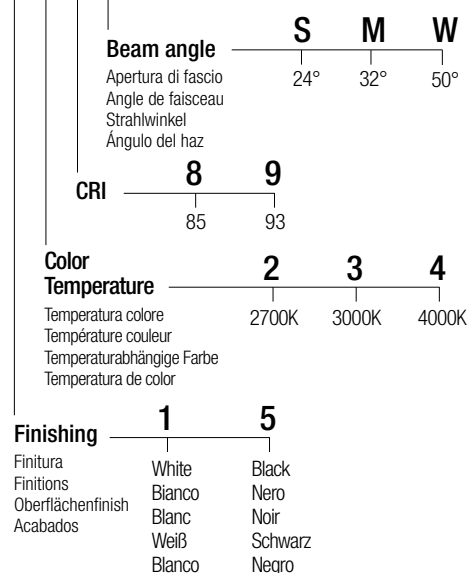

Accessories

Accessori - Accessoires
 Zubehör - Accesorios

MQC004 MQC004B

White
Bianco
Blanc
Weiß
Blanco

Black
Nero
Noir
Schwarz
Negro

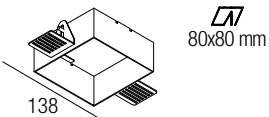

Plasterboard recessing frame
 Flangia per cartongesso
 Boîtier d'encastrement pour plaques de plâtre
 Gehäuses Trockenbau
 Cajetín para placas de yeso

LOH2 LOH2B

White
Bianco
Blanc
Weiß
Blanco

Black
Nero
Noir
Schwarz
Negro

Low luminance louver
 Filtro antiabbagliamento
 Filtre basse luminance
 Geringe Leuchtdichte-Filter
 Filtro de baja luminancia



SMQ201

Milky screen
 Schermo opale
 Écran opale
 Opal-Bildschirm
 Pantalla opal



Note: the screen must be ordered together with the lighting fixture - **Nota:** lo schermo deve essere ordinato congiuntamente all'apparecchio - **Note:** l'écran doit être commandé en même temps que l'appareil
Anmerkung: muss der Bildschirm zusammen mit Leuchtkörper bestellt werden - **Nota:** la pantalla debe pedirse junta con la luminaria

Drivers

Alimentatori - Alimentateurs
 Netzteile - Alimentadores

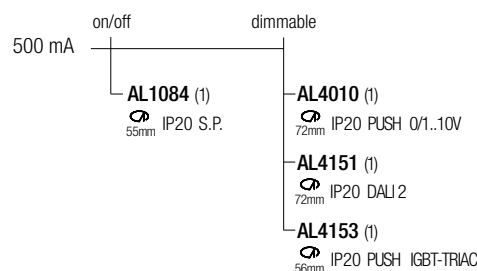

SEXUS 6

design: Rod&Todd

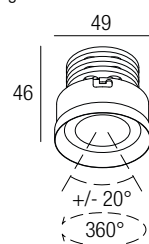

Supply current

Alimentazione
Courant d'alimentation
Stromversorgung
Corriente de alimentación

500 mA (V, 9V)

Power

Potenza
Puissance
Bestuekung
Potencia

6 W

Series wiring

Cablaggio in serie
Câblage en série
Verkabelung in Serie
Cableado en serie



CCT/CRI/Flux

2700K — 540 lm
3000K — 600 lm
4000K — 620 lm

Photometric diagrams

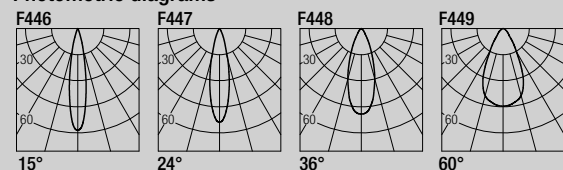

CRI98

2-Step MacAdam

Code Construction

Costruzione del codice - Construction du code produit
Bau der Produkt-Code - Construcción del código de producto

SX6 X X X

Beam angle

	N	S	M	W
Apertura di fascio	15°	24°	36°	60°
Angle de faisceau	15°	24°	36°	60°
Strahlwinkel	15°	24°	36°	60°
Ángulo del haz	15°	24°	36°	60°

Color Temperature

	2	3	4
Temperatura colore	2700K	3000K	4000K
Température couleur	2700K	3000K	4000K
Temperaturabhängige Farbe	2700K	3000K	4000K
Temperatura de color	2700K	3000K	4000K

Finishing

	1	5
Finitura	White	Black
Finitions	Bianco	Nero
Oberflächenfinish	Blanc	Noir
Acabados	Weiß	Schwarz
	Blanco	Negro

Accessories

Accessori - Accessoires
Zubehör - Accesorios

ZQS001 ZQS001B

White	Black
Bianco	Nero
Blanc	Noir
Weiß	Schwarz
Blanco	Negro

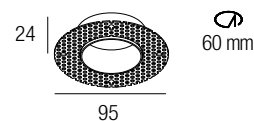

Plasterboard recessing frame
Flangia per cartongesso
Boîtier d'encastrement pour plaques de plâtre
Gehäuses Trockenbau
Cajetín para placas de yeso

LSX601

Low luminance louver
Filtro antiabbagliamento
Filtre basse luminance
Geringe Leuchtdichte-Filter
Filtro de baja luminancia

SSX601

Milky screen
Schermo opale
Écran opale
Opal-Bildschirm
Pantalla opal

Note: the filter and the screen must be ordered together with the lighting fixture - **Nota:** il filtro e lo schermo devono essere ordinati congiuntamente all'apparecchio - **Note:** le filtre et l'écran doivent être commandées en même temps que l'appareil
Anmerkung: müssen der Filter und der Bildschirm zusammen mit Leuchtkörper bestellt werden
Nota: el filtro y la pantalla deben pedirse juntos con la luminaria

AL7022

24VDC/500mA constant current converter
Convertitore 24VDC/500mA corrente costante
Convertisseur 24VDC/500mA courant constant
24VDC/500mA konstanter Strom konverter
Convertidor 24VDC/500mA corriente constante

Drivers

Alimentatori - Alimentateurs
Netzteile - Alimentadores

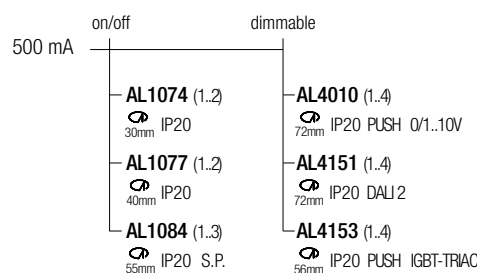

SEXUS 10

design: Rod&Todd

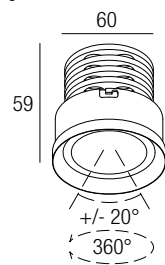

Supply current

Alimentazione
Courant d'alimentation
Stromversorgung
Corriente de alimentación
500 mA (V, 18V)

Power

Potenza
Puissance
Bestuekung
Potencia
10 W

Series wiring

Cablaggio in serie
Câblage en série
Verkabelung in Serie
Cableado en serie



Photometric diagrams

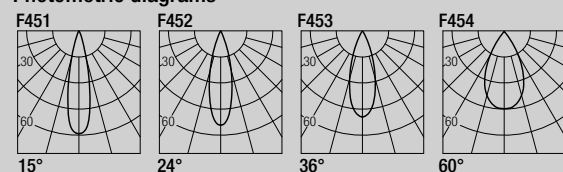

CCT/CRI/Flux

	CRI85	CRI93
2700K	890 lm	840 lm
3000K	1000 lm	930 lm
4000K	1040 lm	960 lm

CRI85 - CRI93

2-Step MacAdam

Code Construction

Costruzione del codice - Construction du code produit
Bau der Produkt-Code - Construcción del código de producto

SX1 X X X X

Beam angle **N S M W**
Apertura di fascio 15° 24° 36° 60°
Angle de faisceau
Strahlwinkel
Ángulo del haz

CRI **8 9**
85 93

Color Temperature **2 3 4**
Temperatura colore 2700K 3000K 4000K
Température couleur
Temperaturabhängige Farbe
Temperatura de color

Finishing **1 5**
Finitura White Black
Finitions Bianco Nero
Oberflächenfinish Blanc Noir
Acabados Weiß Schwarz
Blanco Negro

Drivers

Alimentatori - Alimentateurs
Netzteile - Alimentadores

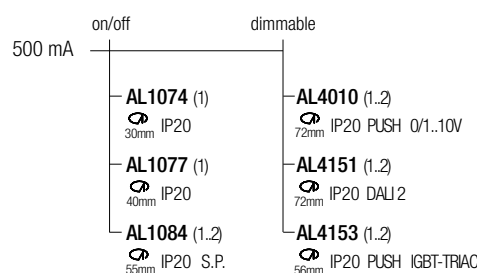

SEXUS 724

design: Rod&Todd

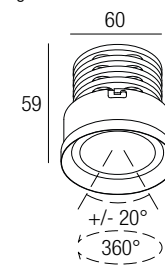

Supply current

Alimentazione
Courant d'alimentation
Stromversorgung
Corriente de alimentación
24 VDC

Power

Potenza
Puissance
Bestuekung
Potencia
7 W

Parallel wiring

Cablaggio in parallelo
Câblage en parallèle
Verkabelung in parallel
Cableado en paralelo



Photometric diagrams

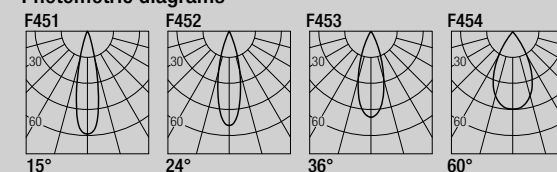

CCT/CRI/Flux

	CRI85	CRI93
2700K	630 lm	590 lm
3000K	700 lm	650 lm
4000K	730 lm	670 lm

CRI85 - CRI93

2-Step MacAdam

Code Construction

Costruzione del codice - Construction du code produit
Bau der Produkt-Code - Construcción del código de producto

SX24 X X X X

Beam angle **N S M W**
Apertura di fascio 15° 24° 36° 60°
Angle de faisceau
Strahlwinkel
Ángulo del haz

CRI **8 9**
85 93

Color Temperature **2 3 4**
Temperatura colore 2700K 3000K 4000K
Température couleur
Temperaturabhängige Farbe
Temperatura de color

Finishing **1 5**
Finitura White Black
Finitions Bianco Nero
Oberflächenfinish Blanc Noir
Acabados Weiß Schwarz
Blanco Negro

Drivers

Alimentatori - Alimentateurs
Netzteile - Alimentadores

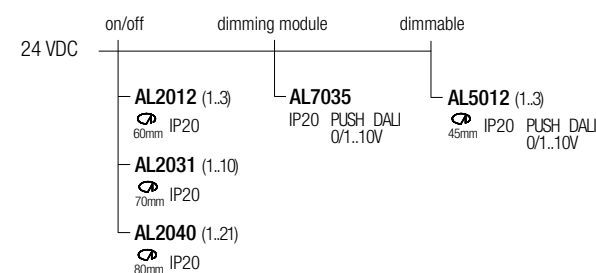

Note: dimming module AL7035 to be used in combination with an on/off 24VDC power supply
Nota: modulo di dimmerazione AL7035 da utilizzare in combinazione con un alimentatore on/off 24VDC
Note: module de variation AL7035 d'intensité à utiliser en combinaison avec une alimentation on/off 24VDC
Anmerkung: Dimmmodul AL7035 zur Verwendung in Kombination mit einem on/off 24VDC-Netzteil
Nota: módulo de regulación AL7035 se utiliza en combinación con una fuente de alimentación on/off 24VDC

Accessories

Accessori - Accessoires
Zubehör - Accesorios

ZQS002 ZQS002B

White Black
Bianco Nero
Blanc Noir
Weiß Schwarz
Blanco Negro

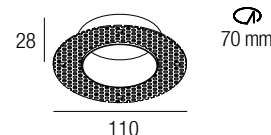

Plasterboard recessing frame
Flangia per cartongesso
Boîtier d'encastrement pour plaques de plâtre
Gehäuses Trockenbau
Cajetín para placas de yeso

LSX101

Low luminance louver
Filtro antiabbagliamento
Filtre basse luminance
Geringe Leuchtdichte-Filter
Filtro de baja luminancia

SSX101

Milky screen
Schermo opale
Écran opale
Opal-Bildschirm
Pantalla opal

Note: the filter and the screen must be ordered together with the lighting fixture - **Nota:** il filtro e lo schermo devono essere ordinati congiuntamente all'apparecchio - **Note:** le filtre et l'écran doivent être commandées en même temps que l'appareil
Anmerkung: müssen der Filter und der Bildschirm zusammen mit Leuchtkörper bestellt werden
Nota: el filtro y la pantalla deben pedirse juntos con la luminaria

AL7022

24VDC/500mA constant current converter
Convertitore 24VDC/500mA corrente costante
Convertisseur 24VDC/500mA courant constant
24VDC/500mA konstanter Strom konverter
Convertidor 24VDC/500mA corriente constante

Accessories

Accessori - Accessoires
Zubehör - Accesorios

ZQS002 ZQS002B

White Black
Bianco Nero
Blanc Noir
Weiß Schwarz
Blanco Negro

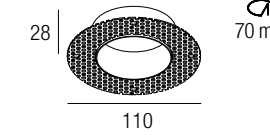

Plasterboard recessing frame
Flangia per cartongesso
Boîtier d'encastrement pour plaques de plâtre
Gehäuses Trockenbau
Cajetín para placas de yeso

LSX2401

Low luminance louver
Filtro antiabbagliamento
Filtre basse luminance
Geringe Leuchtdichte-Filter
Filtro de baja luminancia

SSX2401

Milky screen
Schermo opale
Écran opale
Opal-Bildschirm
Pantalla opal

Note: the filter and the screen must be ordered together with the lighting fixture - **Nota:** il filtro e lo schermo devono essere ordinati congiuntamente all'apparecchio - **Note:** le filtre et l'écran doivent être commandées en même temps que l'appareil
Anmerkung: müssen der Filter und der Bildschirm zusammen mit Leuchtkörper bestellt werden
Nota: el filtro y la pantalla deben pedirse juntos con la luminaria

SEXUS 6 UGR

design: Rod&Todd

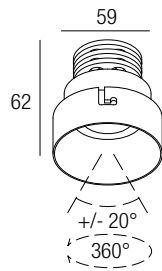

Supply current

Alimentazione
Courant d'alimentation
Stromversorgung
Corriente de alimentación
500 mA (V, 9V)

Power

Potenza
Puissance
Bestuekung
Potencia
6 W

Series wiring

Cablaggio in serie
Câblage en série
Verkabelung in Serie
Cableado en serie



CCT/CRI/Flux

2700K — 540 lm
3000K — 600 lm
4000K — 620 lm

CRI98

2-Step MacAdam

Photometric diagrams

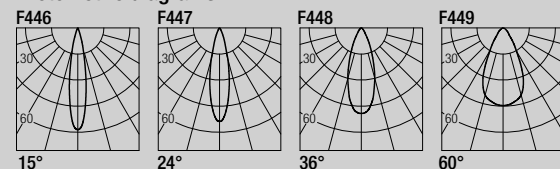

Code Construction

Costruzione del codice - Construction du code produit
Bau der Produkt-Code - Construcción del código de producto

SXU6 X X X

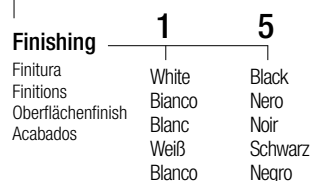
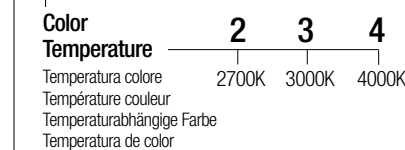
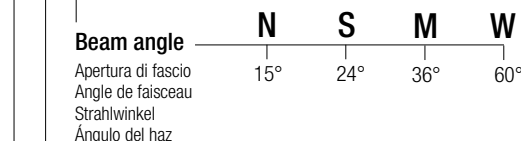

Drivers

Alimentatori - Alimentateurs
Netzteile - Alimentadores

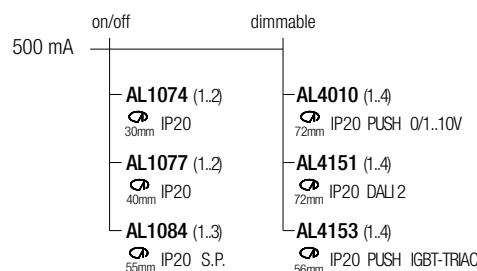

SEXUS 10 UGR

design: Rod&Todd

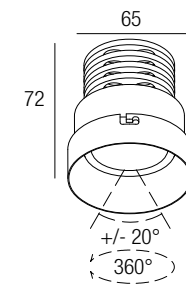

Supply current

Alimentazione
Courant d'alimentation
Stromversorgung
Corriente de alimentación
500 mA (V, 18V)

Power

Potenza
Puissance
Bestuekung
Potencia
10 W

Series wiring

Cablaggio in serie
Câblage en série
Verkabelung in Serie
Cableado en serie



CCT/CRI/Flux

CRI85 CRI93
2700K — 890 lm 840 lm
3000K — 1000 lm 930 lm
4000K — 1040 lm 960 lm

CRI85 - CRI93

2-Step MacAdam

Photometric diagrams

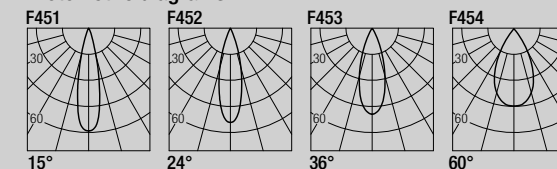

Code Construction

Costruzione del codice - Construction du code produit
Bau der Produkt-Code - Construcción del código de producto

SXU1 X X X X

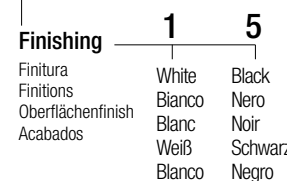
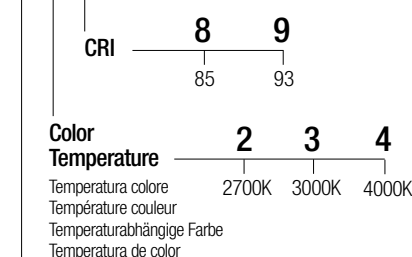
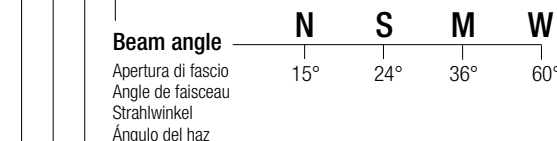

Drivers

Alimentatori - Alimentateurs
Netzteile - Alimentadores

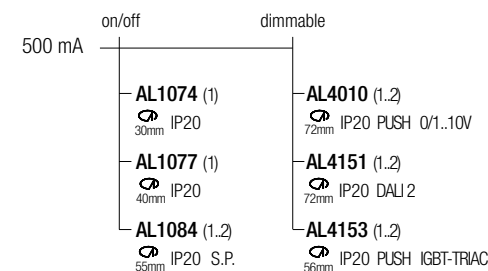

Accessories

Accessori - Accessoires
Zubehör - Accesorios

ZQSU001 ZQSU001B

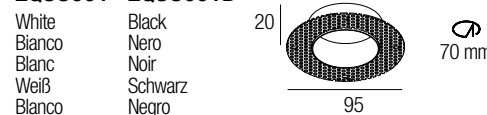

Plasterboard recessing frame
Flangia per cartongesso
Boîtier d'encastrement pour plaques de plâtre
Gehäuses Trockenbau
Cajetín para placas de yeso

LSXU601

Low luminance louver
Filtro antiabbagliamento
Filtre basse luminance
Geringe Leuchtdichte-Filter
Filtro de baja luminancia

SSXU601

Milky screen
Schermo opale
Écran opale
Opal-Bildschirm
Pantalla opal

Note: the filter and the screen must be ordered together with the lighting fixture - **Nota:** il filtro e lo schermo devono essere ordinati congiuntamente all'apparecchio - **Note:** le filtre et l'écran doivent être commandées en même temps que l'appareil
Anmerkung: müssen der Filter und der Bildschirm zusammen mit Leuchtkörper bestellt werden
Nota: el filtro y la pantalla deben pedirse juntos con la luminaria

AL7022

24VDC/500mA constant current converter
Convertitore 24VDC/500mA corrente costante
Convertisseur 24VDC/500mA courant constant
24VDC/500mA konstanter Strom konverter
Convertidor 24VDC/500mA corriente constante

Accessories

Accessori - Accessoires
Zubehör - Accesorios

ZQSU002 ZQSU002B

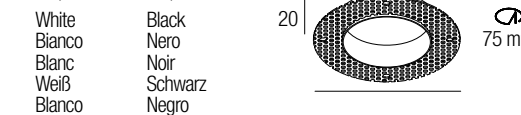

Plasterboard recessing frame
Flangia per cartongesso
Boîtier d'encastrement pour plaques de plâtre
Gehäuses Trockenbau
Cajetín para placas de yeso

LSXU101

Low luminance louver
Filtro antiabbagliamento
Filtre basse luminance
Geringe Leuchtdichte-Filter
Filtro de baja luminancia

SSXU101

Milky screen
Schermo opale
Écran opale
Opal-Bildschirm
Pantalla opal

Note: the filter and the screen must be ordered together with the lighting fixture - **Nota:** il filtro e lo schermo devono essere ordinati congiuntamente all'apparecchio - **Note:** le filtre et l'écran doivent être commandées en même temps que l'appareil
Anmerkung: müssen der Filter und der Bildschirm zusammen mit Leuchtkörper bestellt werden
Nota: el filtro y la pantalla deben pedirse juntos con la luminaria

AL7022

24VDC/500mA constant current converter
Convertitore 24VDC/500mA corrente costante
Convertisseur 24VDC/500mA courant constant
24VDC/500mA konstanter Strom konverter
Convertidor 24VDC/500mA corriente constante

SEXUS 724 UGR

design: Rod&Todd

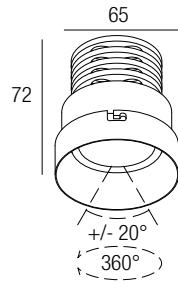

Supply current

Alimentazione
Courant d'alimentation
Stromversorgung
Corriente de alimentación
24 VDC

Power

Potenza
Puissance
Bestuekung
Potencia
7 W

Parallel wiring

Cablaggio in parallelo
Câblage en parallèle
Verkabelung in parallel
Cableado en paralelo



Photometric diagrams

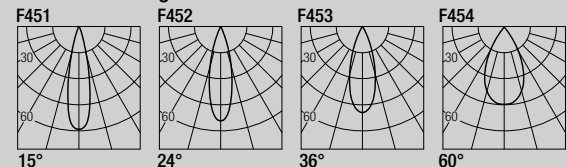

CCT/CRI/Flux

	CRI85	CRI93
2700K	630 lm	590 lm
3000K	700 lm	650 lm
4000K	730 lm	670 lm

CRI85 - CRI93

2-Step MacAdam

Code Construction

Costruzione del codice - Construction du code produit
Bau der Produkt-Code - Construcción del código de producto

SXU24 X X X X

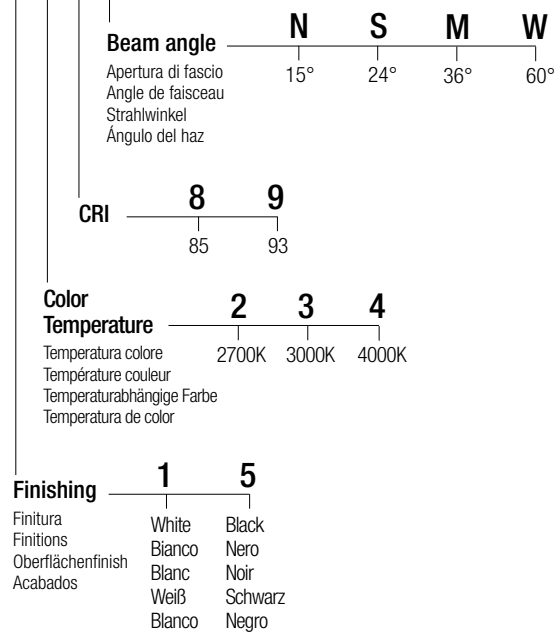

Drivers

Alimentatori - Alimentateurs
Netzteile - Alimentadores

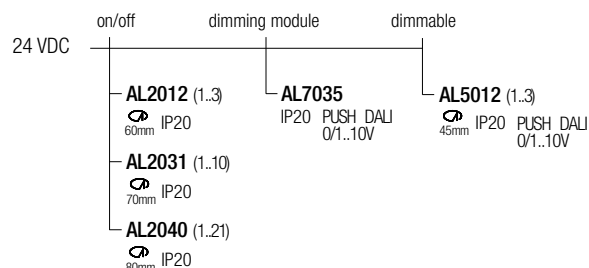

Note: dimming module AL7035 to be used in combination with an on/off 24VDC power supply
Nota: modulo di dimmerazione AL7035 da utilizzare in combinazione con un alimentatore on/off 24VDC
Note: module de variation AL7035 d'intensité à utiliser en combinaison avec une alimentation on/off 24VDC
Anmerkung: Dimmmodul AL7035 zur Verwendung in Kombination mit einem on/off 24VDC-Netzteil
Nota: módulo de regulación AL7035 se utiliza en combinación con una fuente de alimentación on/off 24VDC

- DATASHEET
- INSTALLATION MANUAL
- CERTIFICATIONS
- LDT-IES
- DRAWINGS

TIO TRIMLESS

design: Roberto Mantovani

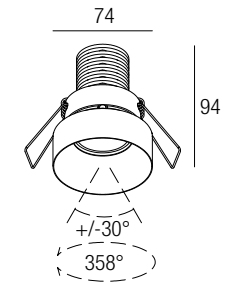

Supply current

Alimentazione
Courant d'alimentation
Stromversorgung
Corriente de alimentación
24 VDC

Power

Potenza
Puissance
Bestuekung
Potencia
7 W

Parallel wiring

Cablaggio in parallelo
Câblage en parallèle
Verkabelung in parallel
Cableado en paralelo



Photometric diagrams

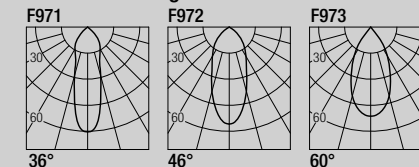

CCT/CRI/Flux

	CRI85	CRI93
2700K	630 lm	590 lm
3000K	700 lm	650 lm
4000K	730 lm	670 lm

CRI85 - CRI93

2-Step MacAdam

Code Construction

Costruzione del codice - Construction du code produit
Bau der Produkt-Code - Construcción del código de producto

TT1 X X X X

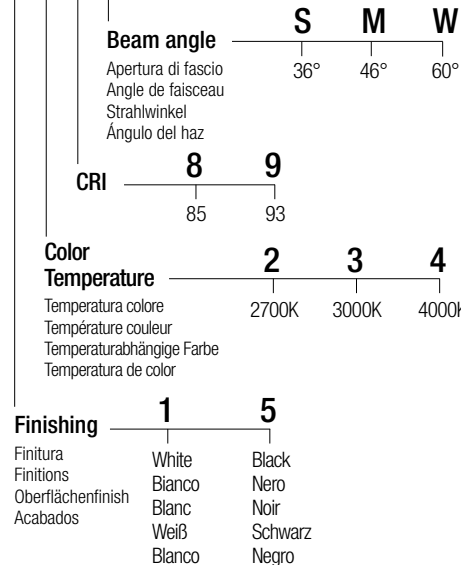

Accessories

Accessori - Accessoires
Zubehör - Accesorios

ZQSU002 ZQSU002B

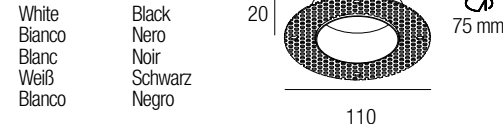

Plasterboard recessing frame
Flangia per cartongesso
Boîtier d'encastrement pour plaques de plâtre
Gehäuses Trockenbau
Cajetin para placas de yeso

LSXU2401

Low luminance louver
Filtro antiabbagliamento
Filtre basse luminance
Geringe Leuchtdichte-Filter
Filtro de baja luminancia

SSXU2401

Milky screen
Schermo opale
Écran opale
Opal-Bildschirm
Pantalla opal

Note: the filter and the screen must be ordered together with the lighting fixture - **Nota:** il filtro e lo schermo devono essere ordinati congiuntamente all'apparecchio - **Note:** le filtre et l'écran doivent être commandées en même temps que l'appareil
Anmerkung: müssen der Filter und der Bildschirm zusammen mit Leuchtkörper bestellt werden
Nota: el filtro y la pantalla deben pedirse juntos con la luminaria

Accessories

Accessori - Accessoires
Zubehör - Accesorios

MQC003 MQC003B

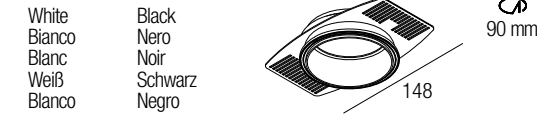

Plasterboard recessing frame
Flangia per cartongesso
Boîtier d'encastrement pour plaques de plâtre
Gehäuses Trockenbau
Cajetin para placas de yeso

STT101

Milky screen
Schermo opale
Écran opale
Opal-Bildschirm
Pantalla opal

Note: the screen must be ordered together with the lighting fixture - **Nota:** lo schermo deve essere ordinato congiuntamente all'apparecchio - **Note:** l'écran doit être commandé en même temps que l'appareil
Anmerkung: muss der Bildschirm zusammen mit Leuchtkörper bestellt werden - **Nota:** la pantalla debe pedirse junta con la luminaria

Drivers

Alimentatori - Alimentateurs
Netzteile - Alimentadores

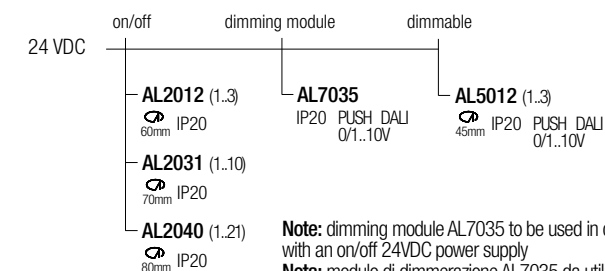

Note: dimming module AL7035 to be used in combination with an on/off 24VDC power supply
Nota: modulo di dimmerazione AL7035 da utilizzare in combinazione con un alimentatore on/off 24VDC
Note: module de variation AL7035 d'intensité à utiliser en combinaison avec une alimentation on/off 24VDC
Anmerkung: Dimmmodul AL7035 zur Verwendung in Kombination mit einem on/off 24VDC-Netzteil
Nota: módulo de regulación AL7035 se utiliza en combinación con una fuente de alimentación on/off 24VDC

- DATASHEET
- INSTALLATION MANUAL
- CERTIFICATIONS
- LDT-IES
- DRAWINGS

RAÙL 10 TRIMLESS

design: Lapo Grassellini

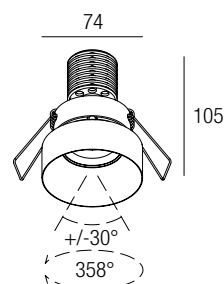
**Supply current**

Alimentazione
Courant d'alimentation
Stromversorgung
Corriente de alimentación

250 mA (V, 36V)**Power**

Potenza
Pouissance
Bestuekung
Potencia

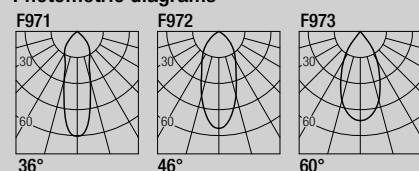
10 W**Photometric diagrams****CCT/CRI/Flux**

	CRI85	CRI93
2700K	890 lm	840 lm
3000K	1000 lm	930 lm
4000K	1040 lm	960 lm

CRI85 - CRI93**2-Step MacAdam****Code Construction**

Costruzione del codice - Construction du code produit
Bau der Produkt-Code - Construcción del código de producto

RT1 X X X X

	S	M	W
Beam angle			
Apertura di fascio	36°	46°	60°
Angle de faisceau			
Strahlwinkel			
Ángulo del haz			
CRI	8	9	
	85	93	
Color Temperature	2	3	4
Temperatura colore	2700K	3000K	4000K
Température couleur			
Temperaturabhängige Farbe			
Temperatura de color			
Finishing	1	5	
Finitura	White	Black	
Finitions	Bianco	Nero	
Oberflächenfinish	Blanc	Noir	
Acabados	Weiß	Schwarz	
	Blanco	Negro	

Drivers

Alimentatori - Alimentateurs
Netzteile - Alimentadores

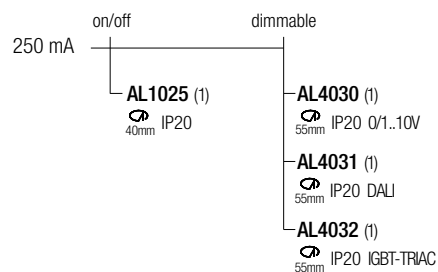
**Accessories**

Accessori - Accessoires
Zubehör - Accesorios

MQC003 MQC003B

White Black
Bianco Nero
Blanc Noir
Weiß Schwarz
Blanco Negro

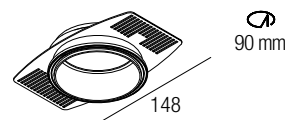

Plasterboard recessing frame
Flangia per cartongesso
Boîtier d'encastrement pour plaques de plâtre
Gehäuses Trockenbau
Cajetín para placas de yeso

LOH1 LOH1B

White Black
Bianco Nero
Blanc Noir
Weiß Schwarz
Blanco Negro

Low luminance louver
Filtro antiabbagliamento
Filtre basse luminance
Geringe Leuchtdichte-Filter
Filtro de baja luminancia

SRT101

Milky screen
Schermo opale
Écran opale
Opal-Bildschirm
Pantalla opal

Note: the screen must be ordered together with the lighting fixture - **Nota:** lo schermo deve essere ordinato congiuntamente all'apparecchio - **Note:** l'écran doit être commandé en même temps que l'appareil
Anmerkung: muss der Bildschirm zusammen mit Leuchtörper bestellt werden - **Nota:** la pantalla debe pedirse junta con la luminaria



MILO 10

design: Lapo Grassellini

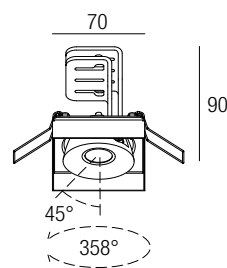

Supply current

Alimentazione
Courant d'alimentation
Stromversorgung
Corriente de alimentación
250 mA (V, 36V)

Power

Potenza
Puissance
Bestuekung
Potencia
10 W



Photometric diagrams

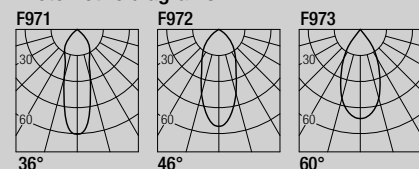

CCT/CRI/Flux

	CRI85	CRI93
2700K	890 lm	840 lm
3000K	1000 lm	930 lm
4000K	1040 lm	960 lm

CRI85 - CRI93
2-Step MacAdam

Code Construction

Costruzione del codice - Construction du code produit
Bau der Produkt-Code - Construcción del código de producto

ML1 X X X X

Beam angle	S	M	W
Apertura di fascio Angle de faisceau Strahlwinkel Ángulo del haz	36°	46°	60°
CRI	8	9	
	85	93	
Color Temperature	2	3	4
Temperatura colore Température couleur Temperaturabhängige Farbe Temperatura de color	2700K	3000K	4000K
Finishing	1	5	
Finitura Finitions Oberflächenfinish Acabados	White Bianco Weiß Blanco	Black Nero Schwarz Negro	

Accessories

Accessori - Accessoires
Zubehör - Accesorios

MLX11Q MLX11QB

White
Bianco
Blanc
Weiß
Blanco

Black
Nero
Noir
Schwarz
Negro

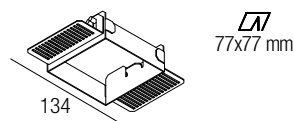

Plasterboard recessing frame
Flangia per cartongesso
Boîtier d'encastrement pour plaques de plâtre
Gehäuses Trockenbau
Cajetín para placas de yeso

SML101

Milky screen
Schermo opale
Écran opale
Opal-Bildschirm
Pantalla opal

Note: the screen must be ordered together with the lighting fixture - **Nota:** lo schermo deve essere ordinato congiuntamente all'apparecchio - **Note:** l'écran doit être commandé en même temps que l'appareil
Anmerkung: muss der Bildschirm zusammen mit Leuchtkörper bestellt werden - **Nota:** la pantalla debe pedirse junta con la luminaria

Drivers

Alimentatori - Alimentateurs
Netzteile - Alimentadores

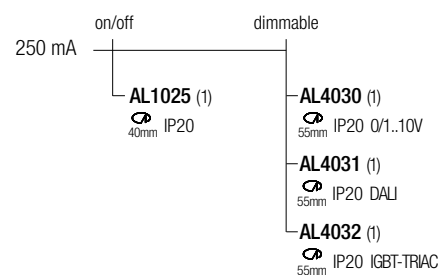

MILO X120

design: Lapo Grassellini

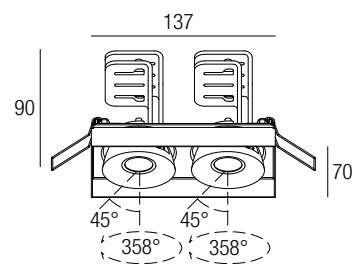

Supply current
Alimentazione
Courant d'alimentation
Stromversorgung
Corriente de alimentación
250 mA (V, 2 x 36V)

Power
Potenza
Puissance
Bestuekung
Potencia
2 x 10 W



Photometric diagrams

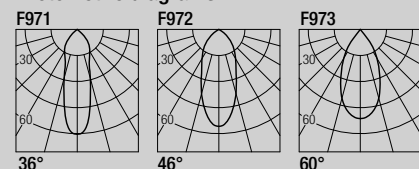

CCT/CRI/Flux	CRI85		CRI93	
	2700K	2 x 890 lm	2 x 840 lm	
3000K	2 x 1000 lm	2 x 930 lm		
4000K	2 x 1040 lm	2 x 960 lm		

CRI85 - CRI93
2-Step MacAdam

Code Construction

Costruzione del codice - Construction du code produit
Bau der Produkt-Code - Construcción del código de producto

MLX12 X X X X

Beam angle Apertura di fascio Angle de faisceau Strahlwinkel Ángulo del haz	S	M	W
	36°	46°	60°
CRI	8	9	
	85	93	
Color Temperature Temperatura colore Température couleur Temperaturabhängige Farbe Temperatura de color	2	3	4
	2700K	3000K	4000K
Finishing Finitura Finitions Oberflächenfinish Acabados	1	5	
	White Bianco Weiß Blanco	Black Nero Noir Schwarz Negro	

Accessories

Accessori - Accessoires
Zubehör - Accesorios

MLX12Q MLX12QB

White
Bianco
Blanc
Weiß
Blanco

Black
Nero
Noir
Schwarz
Negro

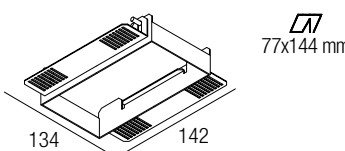

Plasterboard recessing frame
Flangia per cartongesso
Boîtier d'encastrement pour plaques de plâtre
Gehäuses Trockenbau
Cajetín para placas de yeso

SMLX1201

(2 pcs)
Milky screen
Schermo opale
Écran opale
Opal-Bildschirm
Pantalla opal

Note: the screen must be ordered together with the lighting fixture - **Nota:** lo schermo deve essere ordinato congiuntamente all'apparecchio - **Note:** l'écran doit être commandé en même temps que l'appareil
Anmerkung: muss der Bildschirm zusammen mit Leuchtkörper bestellt werden - **Nota:** la pantalla debe pedirse junta con la luminaria

Drivers

Alimentatori - Alimentateurs
Netzteile - Alimentadores

Note: each fixture needs 2 drivers
Nota: considerare 2 alimentatori per ogni apparecchio
Note: chaque appareil nécessite 2 alimentateurs
Anmerkung: Jedes Gerät muss 2-Netzteile
Nota: cada luminaria necesita 2 alimentadores

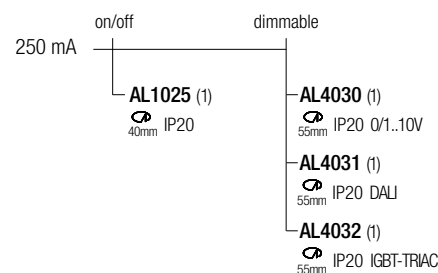

MILO X130

design: Lapo Grassellini

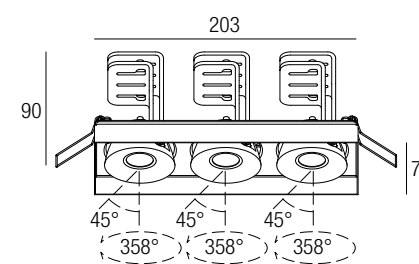

Supply current
Alimentazione
Courant d'alimentation
Stromversorgung
Corriente de alimentación
250 mA (V, 3 x 36V)

Power
Potenza
Puissance
Bestuekung
Potencia
3 x 10 W



Photometric diagrams

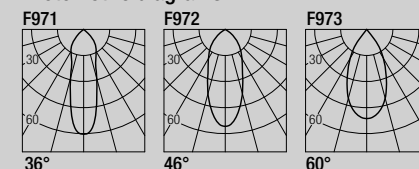

CCT/CRI/Flux	CRI85		CRI93	
	2700K	3 x 890 lm	3 x 840 lm	
3000K	3 x 1000 lm	3 x 930 lm		
4000K	3 x 1040 lm	3 x 960 lm		

CRI85 - CRI93
2-Step MacAdam

Code Construction

Costruzione del codice - Construction du code produit
Bau der Produkt-Code - Construcción del código de producto

MLX13 X X X X

Beam angle Apertura di fascio Angle de faisceau Strahlwinkel Ángulo del haz	S	M	W
	36°	46°	60°
CRI	8	9	
	85	93	
Color Temperature Temperatura colore Température couleur Temperaturabhängige Farbe Temperatura de color	2	3	4
	2700K	3000K	4000K
Finishing Finitura Finitions Oberflächenfinish Acabados	1	5	
	White Bianco Blanc Weiß Blanco	Black Nero Noir Schwarz Negro	

Accessories

Accessori - Accessoires
Zubehör - Accesorios

MLX13Q MLX13QB

White
Bianco
Blanc
Weiß
Blanco

Black
Nero
Noir
Schwarz
Negro

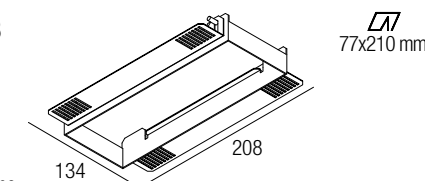

Plasterboard recessing frame
Flangia per cartongesso
Boîtier d'encastrement pour plaques de plâtre
Gehäuses Trockenbau
Cajetín para placas de yeso

SMLX1301

(3 pcs)
Milky screen
Schermo opale
Écran opale
Opal-Bildschirm
Pantalla opal

Note: the screen must be ordered together with the lighting fixture - **Nota:** lo schermo deve essere ordinato congiuntamente all'apparecchio - **Note:** l'écran doit être commandé en même temps que l'appareil
Anmerkung: muss der Bildschirm zusammen mit Leuchtkörper bestellt werden - **Nota:** la pantalla debe pedirse junta con la luminaria

Drivers

Alimentatori - Alimentateurs
Netzteile - Alimentadores

Note: each fixture needs 3 drivers
Nota: considerare 3 alimentatori per ogni apparecchio
Note: chaque appareil nécessite 3 alimentateurs
Anmerkung: Jedes Gerät muss 3-Netzteile
Nota: cada luminaria necesita 3 alimentadores

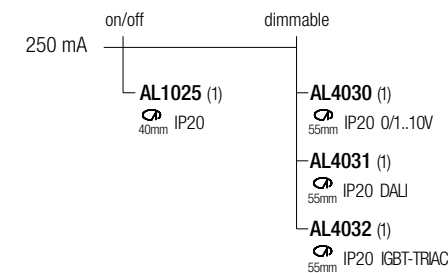

ANDREW

design: Andrea Chiamonti

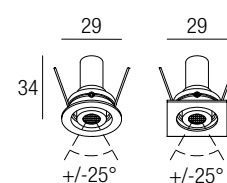

Supply current

Alimentazione
Courant d'alimentation
Stromversorgung
Corriente de alimentación
250 mA (V, 2,9V)

Power

Potenza
Puissance
Bestuekung
Potencia
0,75 W

Series wiring

Cablaggio in serie
Câblage en série
Verkabelung in Serie
Cableado en serie



CCT/CRI/Flux

2700K — 71 lm
3000K — 75 lm
4200K — 86 lm
6000K — 91 lm

CRI85

2-Step MacAdam

Photometric diagrams

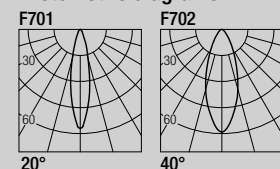

Code Construction

Costruzione del codice - Construction du code produit
Bau der Produkt-Code - Construcción del código de producto

AJ X X X X

Color Temperature	0	1	2	3	6	7	8
Temperatura colore	2700K	3000K	4200K	6000K	Blue	Green	Red
Température couleur					Bleu	Vert	Rouge
Temperaturabhängige Farbe					Blau	Grün	Rot
Temperatura de color					Azul	Rojo	

Beam angle	1	2
Apertura di fascio	20°	40°
Angle de faisceau		
Strahlwinkel		
Angulo del haz		

Finishing	1	2	3	4	5	6	7
Finitura	White	Aluminium	Chrome	Gold	Black	Bronze	Titanium
Finitions	Bianco	Alluminio	Cromo	Oro	Nero	Bronzo	Titane
Oberflächenfinish	Blanc	Aluminium	Chrom	Or	Noir	Bronce	Titane
Acabados	Weiß	Aluminio		Schwarz	Negro		Titan
	Blanco						

Shape	1	2
Forma	Round	Square
Forme	Tondo	Quadro
Form	Ronde	Carré
	Runde	Quadrat
	Redondo	Cuadrado

Accessories

Accessori - Accessoires
Zubehör - Accesorios

CSAN01

Recessing box
Controcassa
Boîtier d'encastrement
Eingießgehäuse
Caja de empotrar

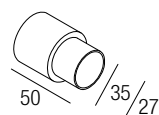

Drivers

Alimentatori - Alimentateurs
Netzteile - Alimentadores

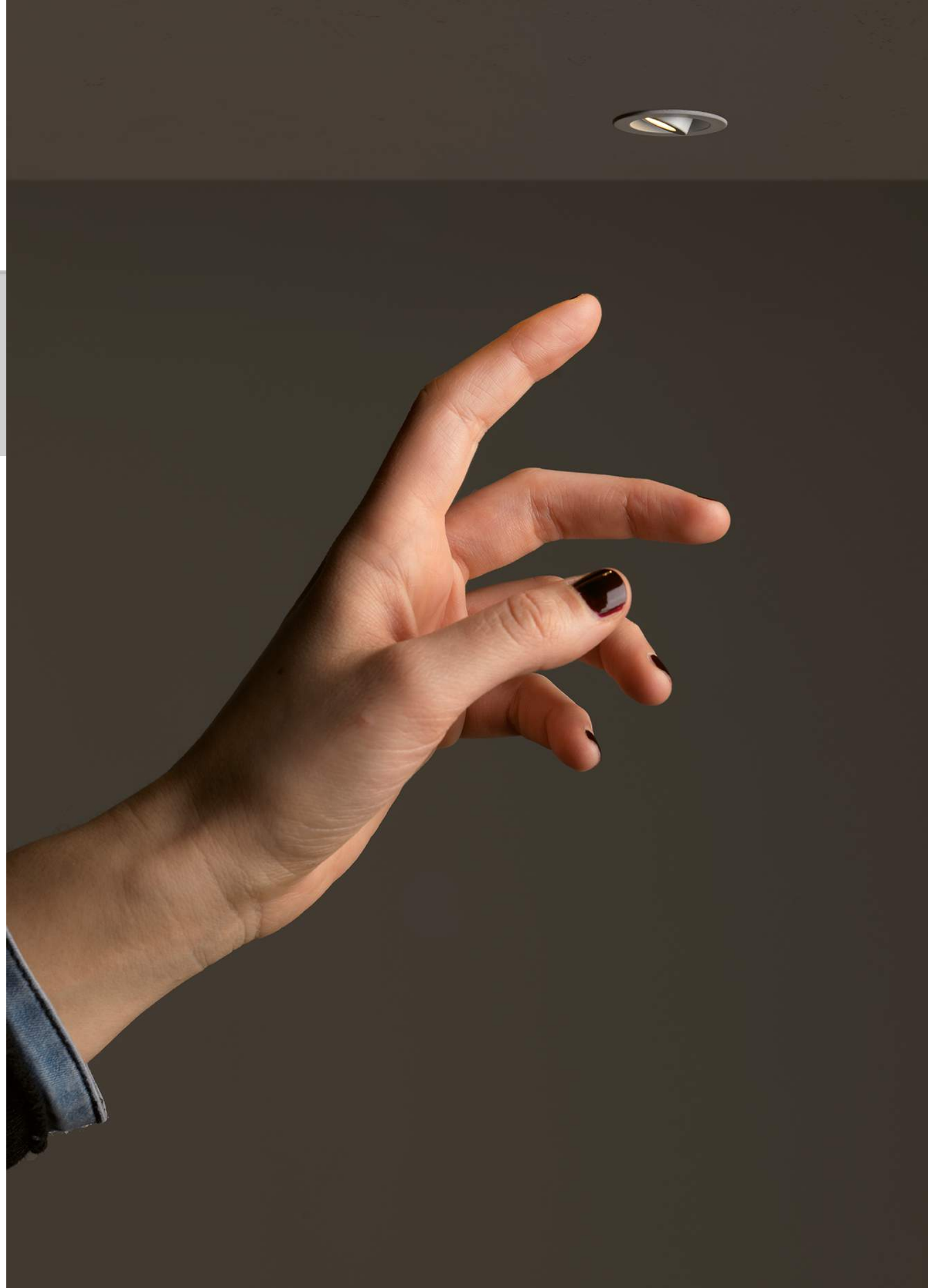
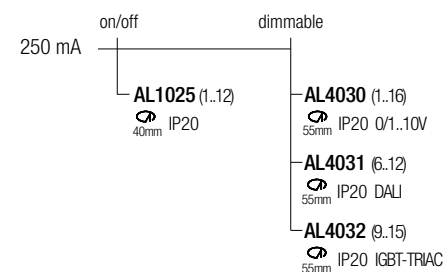

DAHLIA

design: Roberto Mantovani

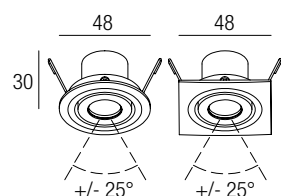

Supply current

Alimentazione
Courant d'alimentation
Stromversorgung
Corriente de alimentación

350-500 mA (V, 2,9V)

Power

Potenza
Puissance
Bestuekung
Potencia

1-2 W

Series wiring

Cablaggio in serie
Câblage en série
Verkabelung in Serie
Cableado en serie



Photometric diagrams

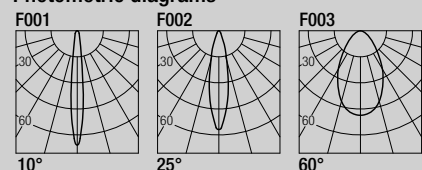

CCT/CRI/Flux

	350mA	500mA
2700K	89 lm	128 lm
3000K	93 lm	133 lm
4200K	103 lm	154 lm
6000K	114 lm	165 lm

CRI85

2-Step MacAdam

Code Construction

Costruzione del codice - Construction du code produit
Bau der Produkt-Code - Construcción del código de producto

SJ X X X X

Color Temperature	0	1	2	3	6	7	8
Temperatura colore	2700K	3000K	4200K	6000K	Blue	Green	Red
Température couleur					Bleu	Vert	Rouge
Temperaturabhängige Farbe					Blau	Grün	Rot
Temperatura de color					Azul	Verde	Rojo

Beam angle	0	1	2
Apertura di fascio	10°	25°	60°
Angle de faisceau			
Strahlwinkel			
Ángulo del haz			

Finishing	1	2	3	4	5	6	7
Finitura	White	Aluminium	Chrome	Gold	Black	Bronze	Titanium
Finitions	Blanco	Aluminium	Chrom	Oro	Nero	Bronzo	Titanio
Oberflächenfinish	Weiß	Aluminium	Chrom	Or	Noir	Bronze	Titane
Acabados	Blanco	Aluminio			Schwarz		Titan
					Negro		

Shape	1	2
Forma	Round	Square
Forme	Tondo	Quadro
Form	Ronde	Carré
	Runde	Quadrat
	Redondo	Cuadrado

Accessories

Accessori - Accessoires
Zubehör - Accesorios

CS1005

Recessing box
Controcassa
Boîtier d'encastrement
Eingießgehäuse
Caja de empotrar

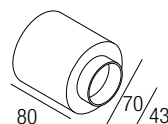

AL7022

24VDC/500mA constant current converter
Convertitore 24VDC/500mA corrente costante
Convertisseur 24VDC/500mA courant constant
24VDC/500mA konstanter Strom konverter
Convertidor 24VDC/500mA corriente constante

Drivers

Alimentatori - Alimentateurs
Netzteile - Alimentadores

350 mA	on/off	dimmable
AL1034 (1.11)	30mm IP20	AL4000 (1.12)
AL1035 (1.11)	40mm IP20	72mm IP20 PUSH 0/1..10V
AL1037 (1.16)	55mm IP20 S.P.	AL4051 (2.14)
AL9011 (1.12)	44mm IP67	72mm IP20 DALI 2
		AL4053 (1.14)
		56mm IP20 PUSH IGBT-TRIAC
		AL8035 (4.16)
		IP67 DALI
500 mA	on/off	dimmable
AL1074 (1.7)	30mm IP20	AL4010 (1.12)
AL1077 (1.6)	40mm IP20	72mm IP20 PUSH 0/1..10V
AL1084 (1.11)	55mm IP20 S.P.	AL4151 (2.14)
AL9051 (1.11)	44mm IP67	72mm IP20 DALI 2
		AL4153 (1.14)
		56mm IP20 PUSH IGBT-TRIAC
		AL8050 (4.16)
		IP67 DALI

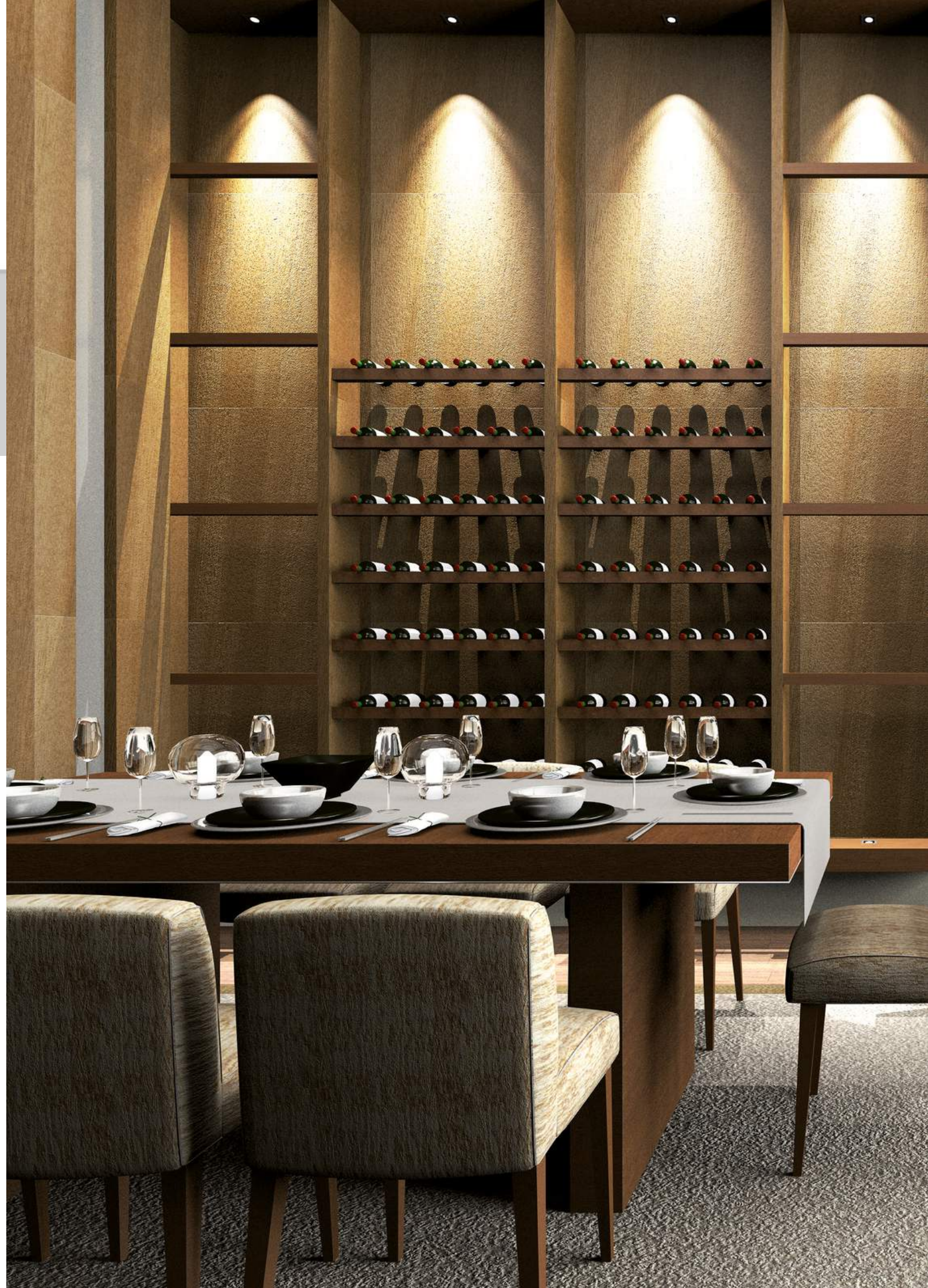

ADAN

design: Roberto Mantovani

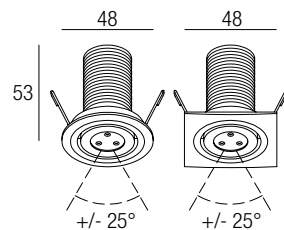

Supply current

Alimentazione
Courant d'alimentation
Stromversorgung
Corriente de alimentación
350-500 mA (V_I 8,7V)

Power

Potenza
Puissance
Bestuekung
Potencia
3-6 W

Series wiring

Cablaggio in serie
Câblage en série
Verkabelung in Serie
Cableado en serie



CCT/CRI/Flux

	350mA	500mA
2700K	267 lm	384 lm
3000K	279 lm	400 lm
4200K	309 lm	462 lm
6000K	342 lm	495 lm

CRI85

2-Step MacAdam

Photometric diagrams

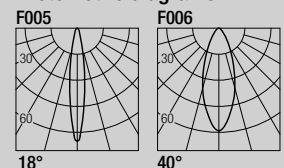

Code Construction

Costruzione del codice - Construction du code produit
Bau der Produkt-Code - Construcción del código de producto

PJ X X X X

Color Temperature	0	1	2	3	6	7	8
Temperatura colore Température couleur Temperaturabhängige Farbe Temperatura de color	2700K	3000K	4200K	6000K	Blue Blu Bleu Blau Azul	Green Verde Vert Grün	Red Rosso Rouge Rot Rojo

Beam angle	1	2
Apertura di fascio Angle de faisceau Strahlwinkel Ángulo del haz	18°	40°

Finishing	1	2	3	4	5	6	7
Finitura Finitions Oberflächenfinish Acabados	White Blanco Blanc Weiß Blanco	Aluminium Alluminio Aluminium Aluminio	Chrome Cromo Chrom	Gold Oro Or	Black Nero Noir Schwarz Negro	Bronze Bronzo Bronce	Titanium Titanio Titane Titan

Shape	1	2
Forma Forme Form	Round Tondo Ronde Runde Redondo	Square Quadro Carré Quadrat Cuadrado

Accessories

Accessori - Accessoires
Zubehör - Accesorios

CS1005

Recessing box
Controcassa
Boîtier d'encastrement
Eingießgehäuse
Caja de empotrar

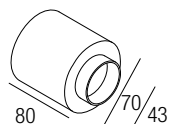

LPJ01

Low luminance louver
Filtro antiabbagliamento
Filtre basse luminance
Geringe Leuchtdichte-Filter
Filtro de baja luminancia



SPJ01

Milky screen
Schermo opale
Écran opale
Opal-Bildschirm
Pantalla opal



Note: the filter and the screen must be ordered together with the lighting fixture - **Nota:** il filtro e lo schermo devono essere ordinati congiuntamente all'apparecchio - **Note:** le filtre et l'écran doivent être commandées en même temps que l'appareil
Anmerkung: müssen der Filter und der Bildschirm zusammen mit Leuchtkörper bestellt werden
Nota: el filtro y la pantalla deben pedirse juntos con la luminaria

AL7022

24VDC/500mA constant current converter
Convertitore 24VDC/500mA corrente costante
Convertisseur 24VDC/500mA courant constant
24VDC/500mA konstanter Strom konverter
Convertidor 24VDC/500mA corriente constante

Drivers

Alimentatori - Alimentateurs
Netzteile - Alimentadores

350 mA		500 mA	
on/off	dimnable	on/off	dimnable
AL1034 (1..3) 30mm IP20	AL4000 (1..4) 72mm IP20 PUSH 0/1..10V	AL1074 (1..2) 30mm IP20	AL4010 (1..4) 72mm IP20 PUSH 0/1..10V
AL1035 (1..3) 40mm IP20	AL4051 (1..4) 72mm IP20 DALI 2	AL1077 (1..2) 40mm IP20	AL4151 (1..4) 72mm IP20 DALI 2
AL1037 (1..3) 55mm IP20 S.P.	AL4053 (1..4) 56mm IP20 PUSH IGBT-TRIAC	AL1084 (1..3) 55mm IP20 S.P.	AL4153 (1..4) 56mm IP20 PUSH IGBT-TRIAC
AL9011 (1..4) 44mm IP67	AL8035 (2..4) IP67 DALI	AL9051 (1..3) 44mm IP67	AL8050 (2..4) IP67 DALI

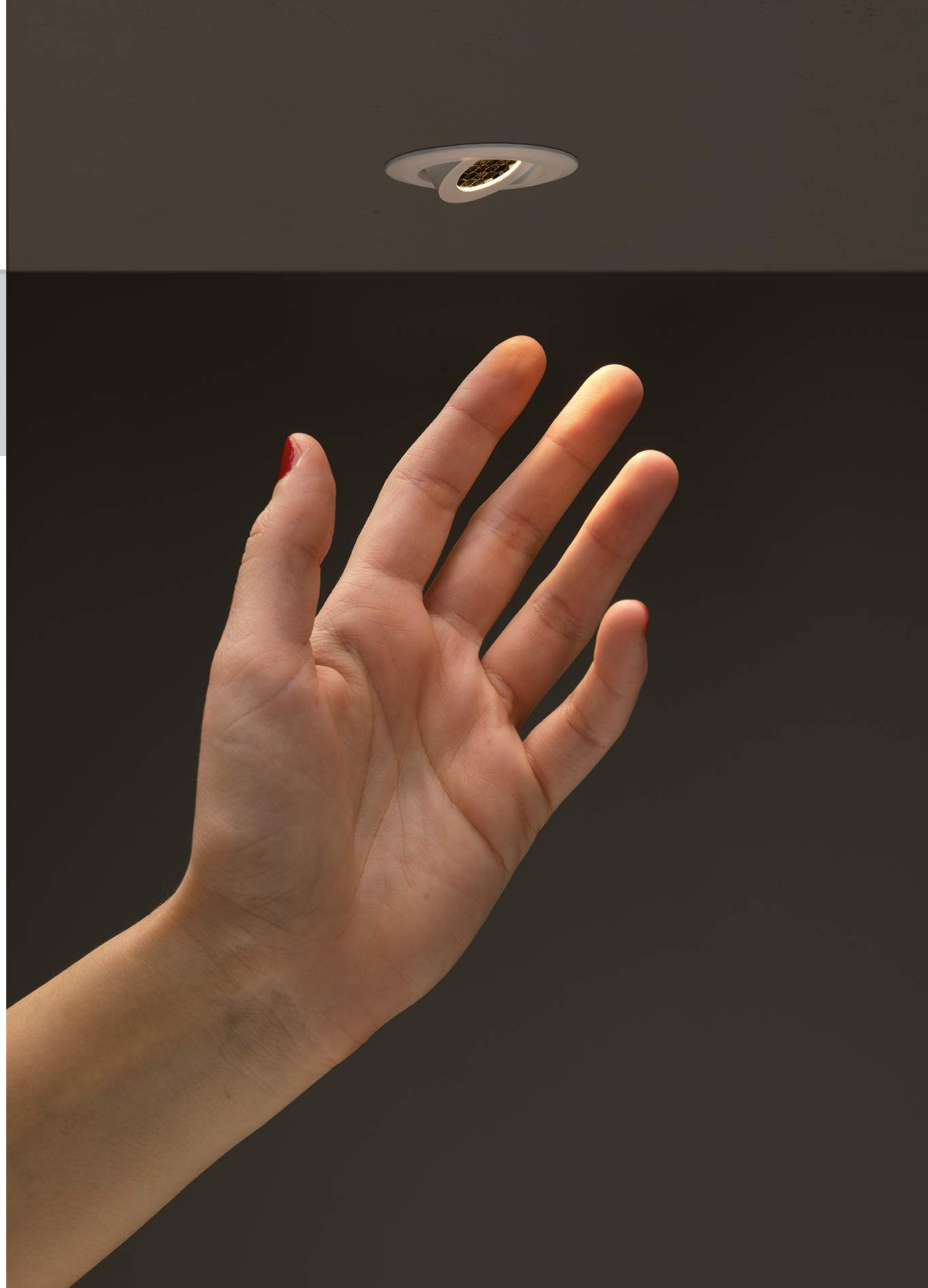

ADAN EVO

design: Roberto Mantovani

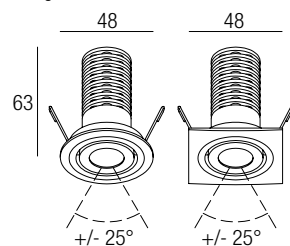

Supply current

Alimentazione
Courant d'alimentation
Stromversorgung
Corriente de alimentación

500 mA (V_i 9V)

Power

Potenza
Puissance
Bestuekung
Potencia

6 W

Series wiring

Cablaggio in serie
Câblage en série
Verkabelung in Serie
Cableado en serie



CCT/CRI/Flux

2700K — 540 lm
3000K — 600 lm
4000K — 620 lm

Photometric diagrams

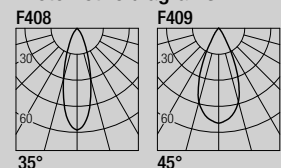

CRI98

2-Step MacAdam

Code Construction

Costruzione del codice - Construction du code produit
Bau der Produkt-Code - Construcción del código de producto

PJE X X X X

Color Temperature

2 3 4
Temperatura colore 2700K 3000K 4000K
Température couleur
Temperaturabhängige Farbe
Temperatura de color

Beam angle

1 2
Apertura di fascio 35° 45°
Angle de faisceau
Strahlwinkel
Angulo del haz

Finishing

1	2	3	4	5	6	7
White	Aluminium	Chrome	Gold	Black	Bronze	Titanium
Blanco	Alluminio	Cromo	Oro	Nero	Bronzo	Titane
Blanc	Aluminium	Chrom	Or	Noir	Bronce	Titan
Weiß	Aluminium			Schwarz		
Blanco				Negro		

Shape

1	2
Round	Square
Tondo	Quadro
Ronde	Carré
Runde	Quadrat
Redondo	Cuadrado

Drivers

Alimentatori - Alimentateurs
Netzteile - Alimentadores

on/off	dimmable
500 mA	
AL1074 (1..2) 30mm IP20	AL4010 (1..4) 72mm IP20 PUSH 0/1..10V
AL1077 (1..2) 40mm IP20	AL4151 (1..4) 72mm IP20 DALI 2
AL1084 (1..3) 55mm IP20 S.P.	AL4153 (1..4) 56mm IP20 PUSH IGBT-TRIAC

Accessories

Accessori - Accessoires
Zubehör - Accesorios

CS1005

Recessing box
Controcassa
Boîtier d'encastrement
Eingießgehäuse
Caja de empotrar

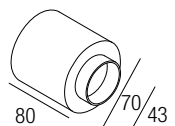

LPJE01

Low luminance louver
Filtro antiabbagliamento
Filtre basse luminance
Geringe Leuchtdichte-Filter
Filtro de baja luminancia



SPJE01

Milky screen
Schermo opale
Écran opale
Opal-Bildschirm
Pantalla opal



Note: the filter and the screen must be ordered together with the lighting fixture - **Nota:** il filtro e lo schermo devono essere ordinati congiuntamente all'apparecchio - **Note:** le filtre et l'écran doivent être commandées en même temps que l'appareil
Anmerkung: müssen der Filter und der Bildschirm zusammen mit Leuchtkörper bestellt werden
Nota: el filtro y la pantalla deben pedirse juntos con la luminaria

AL7022

24VDC/500mA constant current converter
Convertitore 24VDC/500mA corrente costante
Convertisseur 24VDC/500mA courant constant
24VDC/500mA konstanter Strom konverter
Convertidor 24VDC/500mA corriente constante



JOEL 2

design: Roberto Mantovani

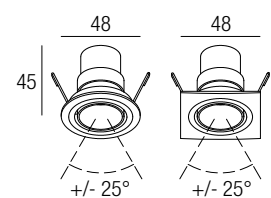

Supply current

Alimentazione
Courant d'alimentation
Stromversorgung
Corriente de alimentación

350-500 mA (V, 2,9V)

Power

Potenza
Puissance
Bestuekung
Potencia

1-2 W

Series wiring

Cablaggio in serie
Câblage en série
Verkabelung in Serie
Cableado en serie



CCT/CRI/Flux

	350mA	500mA
2700K	89 lm	128 lm
3000K	93 lm	133 lm
4200K	103 lm	154 lm
6000K	114 lm	165 lm

CRI85

2-Step MacAdam

Photometric diagrams

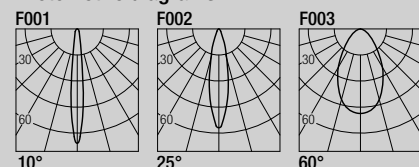

Code Construction

Costruzione del codice - Construction du code produit
Bau der Produkt-Code - Construcción del código de producto

JL2 X X X X

Color

Temperature

	0	1	2	3	6	7	8
Temperatura colore	2700K	3000K	4200K	6000K	Blue	Green	Red
Température couleur					Bleu	Vert	Rouge
Temperaturabhängige Farbe					Blau	Grün	Rot
Temperatura de color					Azul	Verde	Rojo

Beam angle

	0	1	2
Apertura di fascio	10°	25°	60°
Angle de faisceau			
Strahlwinkel			
Angulo del haz			

Finishing

	1	2	3	4	5	6	7
Finitura	White	Aluminium	Chrome	Gold	Black	Bronze	Titanium
Finitions	Bianco	Aluminium	Chrom	Oro	Nero	Bronzo	Titane
Oberflächenfinish	Weiß	Aluminium	Chrom	Or	Schwarz	Bronce	Titan
Acabados	Blanco	Aluminio			Negro		

Shape

	1	2
Forma	Round	Square
Forme	Tondo	Quadro
Form	Ronde	Carré
	Runde	Quadrat
	Redondo	Cuadrado

Accessories

Accessori - Accessoires
Zubehör - Accesorios

CS1005

Recessing box
Controcassa
Boîtier d'encastrement
Eingießgehäuse
Caja de empotrar

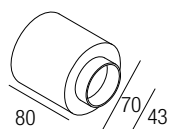

AL7022

24VDC/500mA constant current converter
Convertitore 24VDC/500mA corrente costante
Convertisseur 24VDC/500mA courant constant
24VDC/500mA konstanter Strom konverter
Convertidor 24VDC/500mA corriente constante

Drivers

Alimentatori - Alimentateurs
Netzteile - Alimentadores

350 mA	on/off	dimmable
AL1034 (1..11)	30mm IP20	AL4000 (1..12)
AL1035 (1..11)	40mm IP20	AL4051 (2..14)
AL1037 (1..16)	55mm IP20 S.P.	AL4053 (1..14)
AL9011 (1..12)	44mm IP67	AL8035 (4..16)
		IP67 DALI
500 mA	on/off	dimmable
AL1074 (1..7)	30mm IP20	AL4010 (1..12)
AL1077 (1..6)	40mm IP20	AL4151 (2..14)
AL1084 (1..11)	55mm IP20 S.P.	AL4153 (1..14)
AL9051 (1..11)	44mm IP67	AL8050 (4..16)
		IP67 DALI



JOEL 6

design: Roberto Mantovani

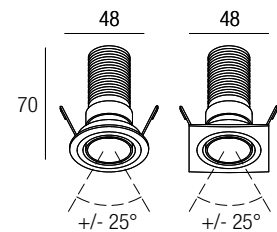

Supply current

Alimentazione
Courant d'alimentation
Stromversorgung
Corriente de alimentación

350-500 mA (V_I 8,7V)

Power

Potenza
Puissance
Bestuekung
Potencia

3-6 W

Series wiring

Cablaggio in serie
Câblage en série
Verkabelung in Serie
Cableado en serie

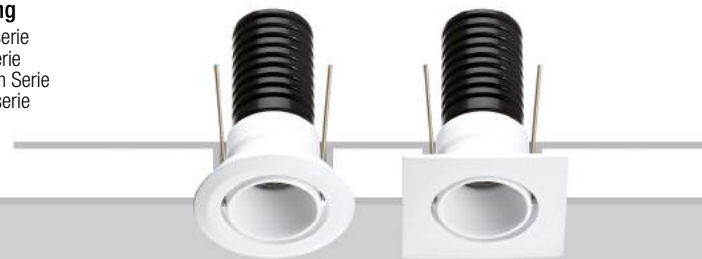

CCT/CRI/Flux

CCT	350mA	500mA
2700K	267 lm	384 lm
3000K	279 lm	400 lm
4200K	309 lm	462 lm
6000K	342 lm	495 lm

CRI85

2-Step MacAdam

Photometric diagrams

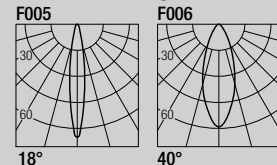

Code Construction

Costruzione del codice - Construction du code produit
Bau der Produkt-Code - Construcción del código de producto

JL6 X X X X

Color Temperature	0	1	2	3	6	7	8
Temperatura colore	2700K	3000K	4200K	6000K	Blue	Green	Red
Température couleur					Bleu	Vert	Rouge
Temperaturabhängige Farbe					Blau	Grün	Rot
Temperatura de color					Azul		Rojo

Beam angle	1	2
Apertura di fascio	18°	40°
Angle de faisceau		
Strahlwinkel		
Angulo del haz		

Finishing	1	2	3	4	5	6	7
Finitura	White	Aluminium	Chrome	Gold	Black	Bronze	Titanium
Finitions	Bianco	Alluminio	Cromo	Oro	Nero	Bronzo	Titanio
Oberflächenfinish	Blanc	Aluminium	Chrom	Or	Noir	Bronce	Titane
Acabados	Weiß	Aluminio		Schwarz			Titan
	Blanco			Negro			

Shape	1	2
Forma	Round	Square
Forme	Tondo	Quadro
Form	Ronde	Carré
	Runde	Quadrat
	Redondo	Cuadrado

Accessories

Accessori - Accessoires
Zubehör - Accesorios

CS1005

Recessing box
Controcassa
Boîtier d'encastrement
Eingieβgehäuse
Caja de empotrar

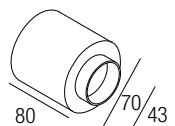

LJL601

Low luminance louver
Filtro antiabbagliamento
Filtre basse luminance
Geringe Leuchtdichte-Filter
Filtro de baja luminancia



SJL601

Milky screen
Schermo opale
Écran opale
Opal-Bildschirm
Pantalla opal



Note: the filter and the screen must be ordered together with the lighting fixture - **Nota:** il filtro e lo schermo devono essere ordinati congiuntamente all'apparecchio - **Note:** le filtre et l'écran doivent être commandées en même temps que l'appareil
Anmerkung: müssen der Filter und der Bildschirm zusammen mit Leuchtkörper bestellt werden
Nota: el filtro y la pantalla deben pedirse juntos con la luminaria

AL7022

24VDC/500mA constant current converter
Convertitore 24VDC/500mA corrente costante
Convertisseur 24VDC/500mA courant constant
24VDC/500mA konstanter Strom konverter
Convertidor 24VDC/500mA corriente constante

Drivers

Alimentatori - Alimentateurs
Netzteile - Alimentadores

350 mA		500 mA	
on/off	dimmable	on/off	dimmable
AL1034 (1..3) 30mm IP20	AL4000 (1..4) 72mm IP20 PUSH 0/1..10V	AL1074 (1..2) 30mm IP20	AL4010 (1..4) 72mm IP20 PUSH 0/1..10V
AL1035 (1..3) 40mm IP20	AL4051 (1..4) 72mm IP20 DALI 2	AL1077 (1..2) 40mm IP20	AL4151 (1..4) 72mm IP20 DALI 2
AL1037 (1..5) 55mm IP20 S.P.	AL4053 (1..4) 56mm IP20 PUSH IGBT-TRIAC	AL1084 (1..3) 55mm IP20 S.P.	AL4153 (1..4) 56mm IP20 PUSH IGBT-TRIAC
AL9011 (1..4) 44mm IP67	AL8035 (2..4) IP67 DALI	AL9051 (1..3) 44mm IP67	AL8050 (2..4) IP67 DALI



JOEL 6 EVO

design: Roberto Mantovani

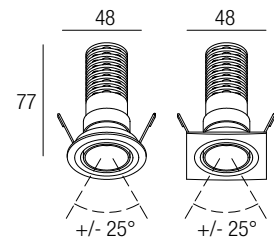

Supply current

Alimentazione
Courant d'alimentation
Stromversorgung
Corriente de alimentación

500 mA (V_i 9V)

Power

Potenza
Puissance
Bestuekung
Potencia

6 W

Series wiring

Cablaggio in serie
Câblage en série
Verkabelung in Serie
Cableado en serie



CCT/CRI/Flux

2700K — 540 lm
3000K — 600 lm
4000K — 620 lm

CRI98

2-Step MacAdam

Photometric diagrams

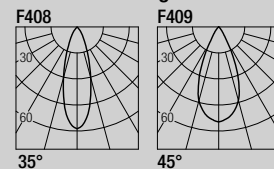

Code Construction

Costruzione del codice - Construction du code produit
Bau der Produkt-Code - Construcción del código de producto

JL6E X X X X

Color Temperature — 2 3 4
Temperatura colore 2700K 3000K 4000K
Température couleur
Temperaturabhängige Farbe
Temperatura de color

Beam angle — 1 2
Apertura di fascio 35° 45°
Angle de faisceau
Strahlwinkel
Ángulo del haz

Finishing — 1 2 3 4 5 6 7
Finitura White Aluminium Chrome Gold Black Bronze Titanium
Finitions Bianco Alluminio Cromo Oro Nero Bronzo Titano
Oberflächenfinish Blanc Aluminium Chrom Or Noir Schwarz Titan
Acabados Weiß Aluminium Chrom Or Schwarz Titan

Shape — 1 2
Forma Round Square
Forme Tondo Quadro
Forme Ronde Carré
Forme Runde Quadrat
Forme Redondo Cuadrado

Drivers

Alimentatori - Alimentateurs
Netzteile - Alimentadores

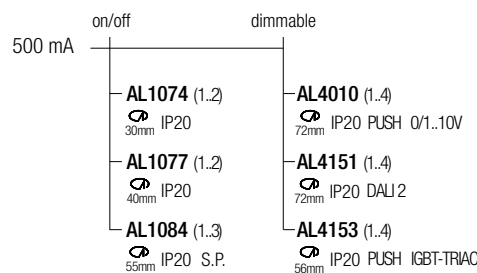

DATASHEET ▶ INSTALLATION MANUAL ▶

CERTIFICATIONS ▶ LDT-IES ▶ DRAWINGS ▶

PLEXUS 6

design: Rod&Todd

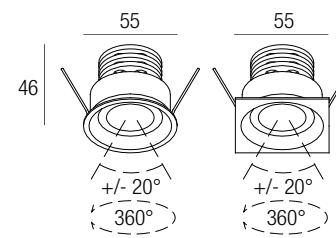

Supply current

Alimentazione
Courant d'alimentation
Stromversorgung
Corriente de alimentación

500 mA (V_i 9V)

Power

Potenza
Puissance
Bestuekung
Potencia

6 W

Series wiring

Cablaggio in serie
Câblage en série
Verkabelung in Serie
Cableado en serie



CCT/CRI/Flux

2700K — 540 lm
3000K — 600 lm
4000K — 620 lm

CRI98

2-Step MacAdam

Photometric diagrams

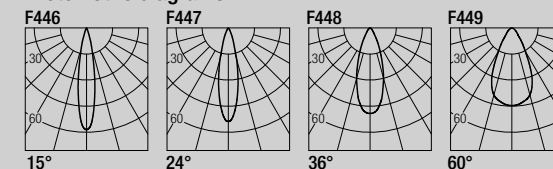

Code Construction

Costruzione del codice - Construction du code produit
Bau der Produkt-Code - Construcción del código de producto

PLX6 X X X X

Beam angle — N S M W
Apertura di fascio 15° 24° 36° 60°
Angle de faisceau
Strahlwinkel
Ángulo del haz

Color Temperature — 2 3 4
Temperatura colore 2700K 3000K 4000K
Température couleur
Temperaturabhängige Farbe
Temperatura de color

Finishing — 1 5
Finitura White Black
Finitions Bianco Nero
Oberflächenfinish Blanc Noir
Acabados Weiß Schwarz
Blanco Negro

Shape — 1 2
Forma Round Square
Forme Tondo Quadro
Forme Ronde Carré
Forme Runde Quadrat
Forme Redondo Cuadrado

Drivers

Alimentatori - Alimentateurs
Netzteile - Alimentadores

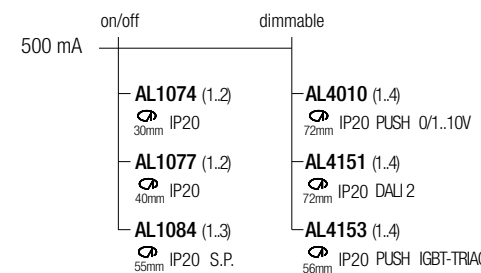

DATASHEET ▶ INSTALLATION MANUAL ▶

CERTIFICATIONS ▶ LDT-IES ▶ DRAWINGS ▶

Accessories

Accessori - Accessoires
Zubehör - Accesorios

CS1005

Recessing box
Controcassa
Boîtier d'encastrement
Eingieβgehäuse
Caja de empotrar

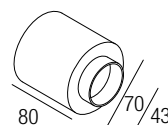

LJL6E01

Low luminance louver
Filtro antiabagliamento
Filtre basse luminance
Geringe Leuchtdichte-Filter
Filtro de baja luminancia



SJL6E01

Milky screen
Schermo opale
Écran opale
Opal-Bildschirm
Pantalla opal



Note: the filter and the screen must be ordered together with the lighting fixture - **Nota:** il filtro e lo schermo devono essere ordinati congiuntamente all'apparecchio - **Note:** le filtre et l'écran doivent être commandées en même temps que l'appareil
Anmerkung: müssen der Filter und der Bildschirm zusammen mit Leuchtkörper bestellt werden
Nota: el filtro y la pantalla deben pedirse juntos con la luminaria

AL7022

24VDC/500mA constant current converter
Convertitore 24VDC/500mA corrente costante
Convertisseur 24VDC/500mA courant constant
24VDC/500mA konstanter Strom konverter
Convertidor 24VDC/500mA corriente constante

Accessories

Accessori - Accessoires
Zubehör - Accesorios

LPLX601

Low luminance louver
Filtro antiabagliamento
Filtre basse luminance
Geringe Leuchtdichte-Filter
Filtro de baja luminancia



SPLX601

Milky screen
Schermo opale
Écran opale
Opal-Bildschirm
Pantalla opal



Note: the filter and the screen must be ordered together with the lighting fixture - **Nota:** il filtro e lo schermo devono essere ordinati congiuntamente all'apparecchio - **Note:** le filtre et l'écran doivent être commandées en même temps que l'appareil
Anmerkung: müssen der Filter und der Bildschirm zusammen mit Leuchtkörper bestellt werden
Nota: el filtro y la pantalla deben pedirse juntos con la luminaria

AL7022

24VDC/500mA constant current converter
Convertitore 24VDC/500mA corrente costante
Convertisseur 24VDC/500mA courant constant
24VDC/500mA konstanter Strom konverter
Convertidor 24VDC/500mA corriente constante

PLEXUS 10

design: Rod&Todd

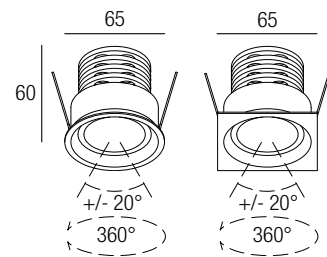

Supply current

Alimentazione
Courant d'alimentation
Stromversorgung
Corriente de alimentación
500 mA (V_i 18V)

Power

Potenza
Puissance
Bestuekung
Potencia
10 W

Series wiring

Cablaggio in serie
Câblage en série
Verkabelung in Serie
Cableado en serie



Photometric diagrams

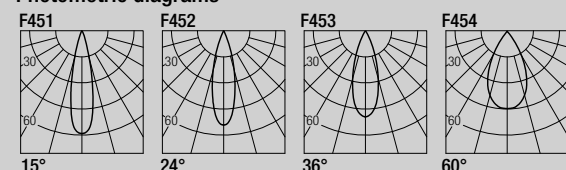

CCT/CRI/Flux

	CRI85	CRI93
2700K	890 lm	840 lm
3000K	1000 lm	930 lm
4000K	1040 lm	960 lm

CRI85 - CRI93
2-Step MacAdam

Code Construction

Costruzione del codice - Construction du code produit
Bau der Produkt-Code - Construcción del código de producto

PLX1 X X X X X

Beam angle
Apertura di fascio
Angle de faisceau
Strahlwinkel
Ángulo del haz

N	S	M	W
15°	24°	36°	60°

CRI

8	9
85	93

Color Temperature
Temperatura colore
Température couleur
Temperaturabhängige Farbe
Temperatura de color

2	3	4
2700K	3000K	4000K

Finishing

1	5
White	Black
Bianco	Nero
Blanc	Noir
Weiß	Schwarz
Blanco	Negro

Shape

1	2
Round	Square
Tondo	Quadro
Ronde	Carrè
Runde	Quadrat
Redondo	Cuadrado

Drivers

Alimentatori - Alimentateurs
Netzteile - Alimentadores

on/off	dimmable
AL1074 (1) 30mm IP20	AL4010 (1..2) 72mm IP20 PUSH 0/1..10V
AL1077 (1) 40mm IP20	AL4151 (1..2) 72mm IP20 DALI 10
AL1084 (1..2) 50mm IP20 S.P.	AL4153 (1..2) 56mm IP20 PUSH IGBT-TRIAC

Accessories

Accessori - Accessoires
Zubehör - Accesorios

LPLX101

Low luminance louver
Filtro antiabbagliamento
Filtre basse luminance
Geringe Leuchtdichte-Filter
Filtro de baja luminancia

SPLX101

Milky screen
Schermo opale
Écran opale
Opal-Bildschirm
Pantalla opal

Note: the filter and the screen must be ordered together with the lighting fixture - **Nota:** il filtro e lo schermo devono essere ordinati congiuntamente all'apparecchio - **Note:** le filtre et l'écran doivent être commandées en même temps que l'appareil
Anmerkung: müssen der Filter und der Bildschirm zusammen mit Leuchtkörper bestellt werden
Nota: el filtro y la pantalla deben pedirse juntos con la luminaria

AL7022

24VDC/500mA constant current converter
Convertitore 24VDC/500mA corrente costante
Convertisseur 24VDC/500mA courant constant
24VDC/500mA konstanter Strom konverter
Convertidor 24VDC/500mA corriente constante



PLEXUS 724

design: Rod&Todd

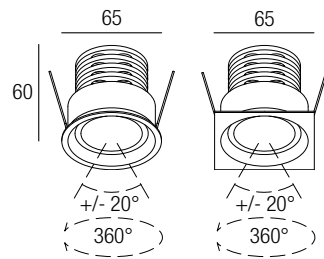

Supply current

Alimentazione
 Courant d'alimentation
 Stromversorgung
 Corriente de alimentación
24 VDC

Power

Potenza
 Pouissance
 Bestuekung
 Potencia
7 W

Parallel wiring

Cablaggio in parallelo
 Câblage en parallèle
 Verkabelung in parallel
 Cableado en paralelo



CCT/CRI/Flux

	CRI85	CRI93
2700K	630 lm	590 lm
3000K	700 lm	650 lm
4000K	730 lm	670 lm

CRI85 - CRI93

2-Step MacAdam

Photometric diagrams

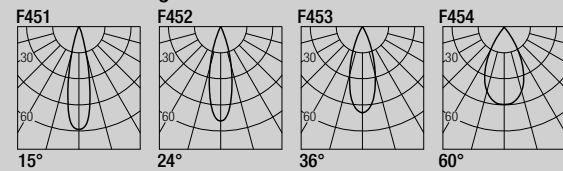

Code Construction

Costruzione del codice - Construction du code produit
 Bau der Produkt-Code - Construcción del código de producto

PLX24.X.X.X.X.X

Beam angle	N	S	M	W
Apertura di fascio Angle de faisceau Strahlwinkel Angulo del haz	15°	24°	36°	60°

CRI	8	9
	85	93

Color Temperature	2	3	4
Temperatura colore Température couleur Temperaturabhängige Farbe Temperatura de color	2700K	3000K	4000K

Finishing	1	5
Finitura Finitions Oberflächenfinish Acabados	White Bianco Blanc Weiß Blanco	Black Nero Noir Schwarz Negro

Shape	1	2
Forma Forme Form	Round Tondo Ronde Runde Redondo	Square Quadro Carré Quadrat Cuadrado

Drivers

Alimentatori - Alimentateurs
 Netzteile - Alimentadores

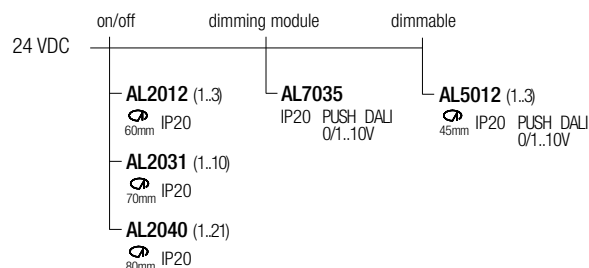

Note: dimming module AL7035 to be used in combination with an on/off 24VDC power supply
Nota: modulo di dimmerazione AL7035 da utilizzare in combinazione con un alimentatore on/off 24VDC
Note: module de variation AL7035 d'intensité à utiliser en combinaison avec une alimentation on/off 24VDC
Anmerkung: Dimmmodul AL7035 zur Verwendung in Kombination mit einem on/off 24VDC-Netzteil
Nota: módulo de regulación AL7035 se utiliza en combinación con una fuente de alimentación on/off 24VDC

PLEXUS 6 UGR

design: Rod&Todd

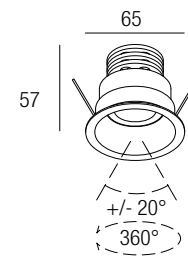

Supply current

Alimentazione
 Courant d'alimentation
 Stromversorgung
 Corriente de alimentación
500 mA (V_i 9V)

Power

Potenza
 Pouissance
 Bestuekung
 Potencia
6 W

Series wiring

Cablaggio in serie
 Câblage en série
 Verkabelung in Serie
 Cableado en serie



CCT/CRI/Flux

2700K	540 lm
3000K	600 lm
4000K	620 lm

CRI98

2-Step MacAdam

Photometric diagrams

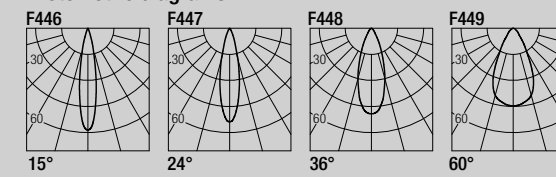

Code Construction

Costruzione del codice - Construction du code produit
 Bau der Produkt-Code - Construcción del código de producto

PLXU6.X.X.X

Beam angle	N	S	M	W
Apertura di fascio Angle de faisceau Strahlwinkel Angulo del haz	15°	24°	36°	60°

Color Temperature	2	3	4
Temperatura colore Température couleur Temperaturabhängige Farbe Temperatura de color	2700K	3000K	4000K

Finishing	1	5
Finitura Finitions Oberflächenfinish Acabados	White Bianco Blanc Weiß Blanco	Black Nero Noir Schwarz Negro

Drivers

Alimentatori - Alimentateurs
 Netzteile - Alimentadores

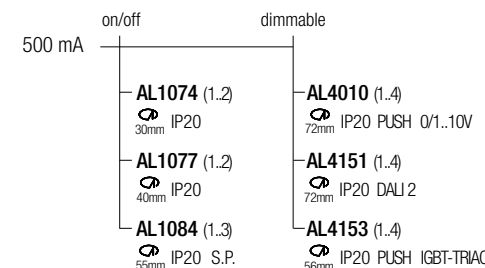

Accessories

Accessori - Accessoires
 Zubehör - Accesorios

LPLXU601

Low luminance louver
 Filtro antiabbagliamento
 Filtre basse luminance
 Geringe Leuchtdichte-Filter
 Filtro de baja luminancia

SPLXU601

Milky screen
 Schermo opale
 Écran opale
 Opal-Bildschirm
 Pantalla opal

Note: the filter and the screen must be ordered together with the lighting fixture - **Nota:** il filtro e lo schermo devono essere ordinati congiuntamente all'apparecchio - **Note:** le filtre et l'écran doivent être commandées en même temps que l'appareil
Anmerkung: müssen der Filter und der Bildschirm zusammen mit Leuchtkörper bestellt werden
Nota: el filtro y la pantalla deben pedirse juntos con la luminaria

AL7022

24VDC/500mA constant current converter
 Convertitore 24VDC/500mA corrente costante
 Convertisseur 24VDC/500mA courant constant
 24VDC/500mA konstanter Strom konverter
 Convertidor 24VDC/500mA corriente constante

PLEXUS 10 UGR

design: Rod&Todd

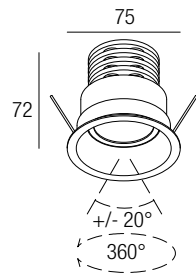

Supply current

Alimentazione
Courant d'alimentation
Stromversorgung
Corriente de alimentación
500 mA (V_I 18V)

Power

Potenza
Puissance
Bestuekung
Potencia
10 W

Series wiring

Cablaggio in serie
Câblage en série
Verkabelung in Serie
Cableado en serie



CCT/CRI/Flux

	CRI85	CRI93
2700K	890 lm	840 lm
3000K	1000 lm	930 lm
4000K	1040 lm	960 lm

CRI85 - CRI93
2-Step MacAdam

Photometric diagrams

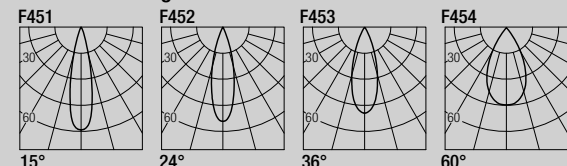

Code Construction

Costruzione del codice - Construction du code produit
Bau der Produkt-Code - Construcción del código de producto

PLXU1 X X X X

Beam angle
Apertura di fascio
Angle de faisceau
Strahlwinkel
Ángulo del haz

N S M W
15° 24° 36° 60°

CRI
8 9
85 93

Color Temperature
Temperatura colore
Température couleur
Temperaturabhängige Farbe
Temperatura de color

2 3 4
2700K 3000K 4000K

Finishing
Finitura
Finitions
Oberflächenfinish
Acabados

1 5
White Nero
Bianco Noir
Weiß Schwarz
Blanco Negro

Drivers

Alimentatori - Alimentateurs
Netzteile - Alimentadores

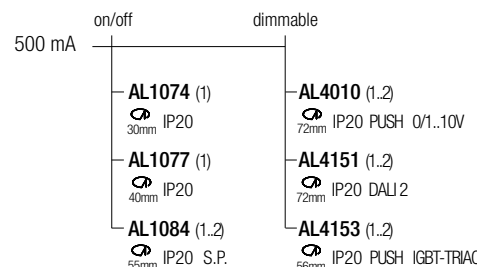

PLEXUS 724 UGR

design: Rod&Todd

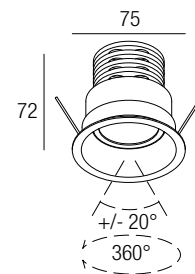

Supply current

Alimentazione
Courant d'alimentation
Stromversorgung
Corriente de alimentación
24 VDC

Power

Potenza
Puissance
Bestuekung
Potencia
7 W

Parallel wiring

Cablaggio in parallelo
Câblage en parallèle
Verkabelung in parallel
Cableado en paralelo



CCT/CRI/Flux

	CRI85	CRI93
2700K	630 lm	590 lm
3000K	700 lm	650 lm
4000K	730 lm	670 lm

CRI85 - CRI93
2-Step MacAdam

Photometric diagrams

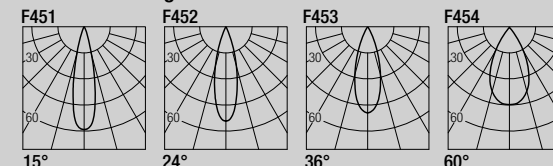

Code Construction

Costruzione del codice - Construction du code produit
Bau der Produkt-Code - Construcción del código de producto

PLXU24 X X X X

Beam angle
Apertura di fascio
Angle de faisceau
Strahlwinkel
Ángulo del haz

N S M W
15° 24° 36° 60°

CRI
8 9
85 93

Color Temperature
Temperatura colore
Température couleur
Temperaturabhängige Farbe
Temperatura de color

2 3 4
2700K 3000K 4000K

Finishing
Finitura
Finitions
Oberflächenfinish
Acabados

1 5
White Nero
Bianco Noir
Weiß Schwarz
Blanco Negro

Drivers

Alimentatori - Alimentateurs
Netzteile - Alimentadores

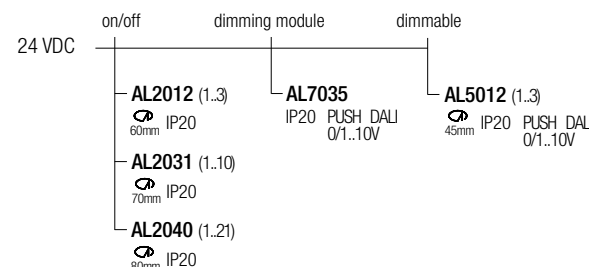

Note: dimming module AL7035 to be used in combination with an on/off 24VDC power supply
Nota: modulo di dimmerazione AL7035 da utilizzare in combinazione con un alimentatore on/off 24VDC
Note: module de variation AL7035 d'intensité à utiliser en combinaison avec une alimentation on/off 24VDC
Anmerkung: Dimmmodul AL7035 zur Verwendung in Kombination mit einem on/off 24VDC-Netzteil
Nota: módulo de regulación AL7035 se utiliza en combinación con una fuente de alimentación on/off 24VDC

Accessories

Accessori - Accessoires
Zubehör - Accesorios

LPLXU101

Low luminance louver
Filtro antiabbagliamento
Filtre basse luminance
Geringe Leuchtdichte-Filter
Filtro de baja luminancia

SPLXU101

Milky screen
Schermo opale
Écran opale
Opal-Bildschirm
Pantalla opal

Note: the filter and the screen must be ordered together with the lighting fixture - **Nota:** il filtro e lo schermo devono essere ordinati congiuntamente all'apparecchio - **Note:** le filtre et l'écran doivent être commandées en même temps que l'appareil
Anmerkung: müssen der Filter und der Bildschirm zusammen mit Leuchtkörper bestellt werden
Nota: el filtro y la pantalla deben pedirse juntos con la luminaria

AL7022

24VDC/500mA constant current converter
Convertitore 24VDC/500mA corrente costante
Convertisseur 24VDC/500mA courant constant
24VDC/500mA konstanter Strom konverter
Convertidor 24VDC/500mA corriente constante

Accessories

Accessori - Accessoires
Zubehör - Accesorios

LPLXU2401

Low luminance louver
Filtro antiabbagliamento
Filtre basse luminance
Geringe Leuchtdichte-Filter
Filtro de baja luminancia

SPLXU2401

Milky screen
Schermo opale
Écran opale
Opal-Bildschirm
Pantalla opal

Note: the filter and the screen must be ordered together with the lighting fixture - **Nota:** il filtro e lo schermo devono essere ordinati congiuntamente all'apparecchio - **Note:** le filtre et l'écran doivent être commandées en même temps que l'appareil
Anmerkung: müssen der Filter und der Bildschirm zusammen mit Leuchtkörper bestellt werden
Nota: el filtro y la pantalla deben pedirse juntos con la luminaria

TIO

design: Roberto Mantovani

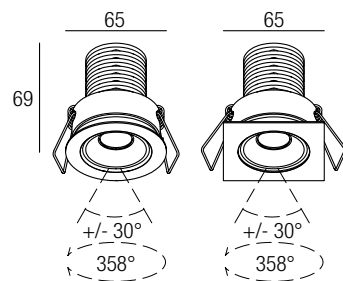

Supply current
 Alimentazione
 Courant d'alimentation
 Stromversorgung
 Corriente de alimentación
24 VDC

Power
 Potenza
 Pouissance
 Bestuekung
 Potencia
7 W

Parallel wiring
 Cablaggio in parallelo
 Câblage en parallèle
 Verkabelung in parallel
 Cableado en paralelo



CCT/CRI/Flux

	CRI85	CRI93
2700K	630 lm	590 lm
3000K	700 lm	650 lm
4000K	730 lm	670 lm

Photometric diagrams

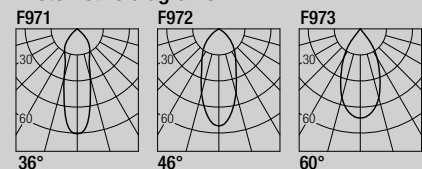

CRI85 - CRI93
2-Step MacAdam

Code Construction

Costruzione del codice - Construction du code produit
 Bau der Produkt-Code - Construcción del código de producto

T X X X X

Beam angle
 Apertura di fascio
 Angle de faisceau
 Strahlwinkel
 Ángulo del haz

S M W
 36° 46° 60°

CRI
 8 9
 85 93

Color Temperature
 Temperatura colore
 Température couleur
 Temperaturabhängige Farbe
 Temperatura de color

2 3 4
 2700K 3000K 4000K

Finishing

	1	2	5
Finitura	White	Grey	Black
Finitions	Bianco	Grigio	Nero
Oberflächenfinish	Blanc	Gris	Noir
Acabados	Weiß	Grau	Schwarz
	Blanco		Negro

Shape

	1	2
Forma	Round	Square
Forme	Tondo	Quadro
Ronde	Ronde	Carrè
Runde	Runde	Quadrat
Redondo	Redondo	Cuadrado

Accessories

Accessori - Accessoires
 Zubehör - Accesorios

ST01

Milky screen
 Schermo opale
 Écran opale
 Opal-Bildschirm
 Pantalla opal

Note: the screen must be ordered together with the lighting fixture - **Nota:** lo schermo deve essere ordinato congiuntamente all'apparecchio - **Note:** l'écran doit être commandé en même temps que l'appareil
Anmerkung: muss der Bildschirm zusammen mit Leuchtkörper bestellt werden - **Nota:** la pantalla debe pedirse junta con la luminaria

Drivers

Alimentatori - Alimentateurs
 Netzteile - Alimentadores

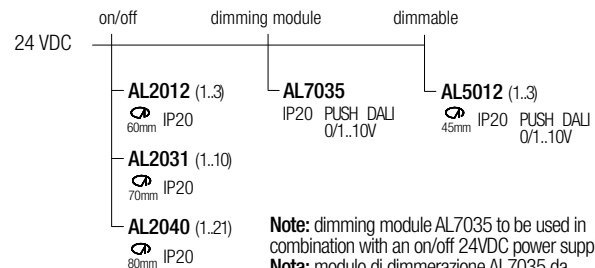

Note: dimming module AL7035 to be used in combination with an on/off 24VDC power supply
Nota: modulo di dimmerazione AL7035 da utilizzare in combinazione con un alimentatore on/off 24VDC
Note: module de variation AL7035 d'intensité à utiliser en combinaison avec une alimentation on/off 24VDC
Anmerkung: Dimmmodul AL7035 zur Verwendung in Kombination mit einem on/off 24VDC-Netzteil
Nota: módulo de regulación AL7035 se utiliza en combinación con una fuente de alimentación on/off 24VDC



RAÙL 10

design: Lapo Grassellini

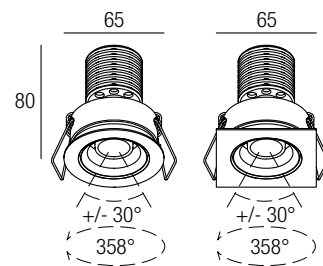

Supply current

Alimentazione
 Courant d'alimentation
 Stromversorgung
 Corriente de alimentación
250 mA (V, 36V)

Power

Potenza
 Pouissance
 Bestuekung
 Potencia
10 W



CCT/CRI/Flux

	CRI85	CRI93
2700K	890 lm	840 lm
3000K	1000 lm	930 lm
4000K	1040 lm	960 lm

Photometric diagrams

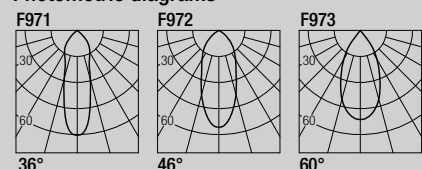

CRI85 - CRI93

2-Step MacAdam

Code Construction

Costruzione del codice - Construction du code produit
 Bau der Produkt-Code - Construcción del código de producto

R1 X X X X X

Beam angle	S	M	W
Apertura di fascio Angle de faisceau Strahlwinkel Ángulo del haz	36°	46°	60°

CRI	8	9
	85	93

Color Temperature	2	3	4
Temperatura colore Température couleur Temperaturabhängige Farbe Temperatura de color	2700K	3000K	4000K

Finishing	1	2	5
Finitura Finitions Oberflächenfinish Acabados	White Bianco Blanc Weiß Blanco	Grey Grigio Gris Grau	Black Nero Noir Schwarz Negro

Shape	1	2
Forma Forme Form	Round Tondo Ronde Runde Redondo	Square Quadro Carré Quadrat Cuadrado

Accessories

Accessori - Accessoires
 Zubehör - Accesorios

LOH1 LOH1B LOH1G

White	Black	Grey
Bianco	Nero	Grigio
Blanc	Noir	Gris
Weiß	Schwarz	Grau
Bianco	Negro	

Low luminance louver
 Filtro antiabbagliamento
 Filtre basse luminance
 Geringe Leuchtdichte-Filter
 Filtro de baja luminancia

SR101

Milky screen
 Schermo opale
 Écran opale
 Opal-Bildschirm
 Pantalla opal

Note: the screen must be ordered together with the lighting fixture - **Nota:** lo schermo deve essere ordinato congiuntamente all'apparecchio - **Note:** l'écran doit être commandé en même temps que l'appareil

Anmerkung: muss der Bildschirm zusammen mit Leuchtkörper bestellt werden - **Nota:** la pantalla debe pedirse junta con la luminaria

Drivers

Alimentatori - Alimentateurs
 Netzteile - Alimentadores

250 mA	on/off	dimmable
	AL1025 (1) 40mm IP20	AL4030 (1) 55mm IP20 0/1..10V
		AL4031 (1) 55mm IP20 DALI
		AL4032 (1) 55mm IP20 IGBT-TRIAC



TIO UGR

design: Roberto Mantovani

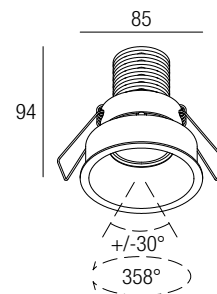

Supply current

Alimentazione
Courant d'alimentation
Stromversorgung
Corriente de alimentación

24 VDC

Power

Potenza
Puissance
Bestuekung
Potencia

7 W

Parallel wiring

Cablaggio in parallelo
Câblage en parallèle
Verkabelung in parallel
Cableado en paralelo



Photometric diagrams

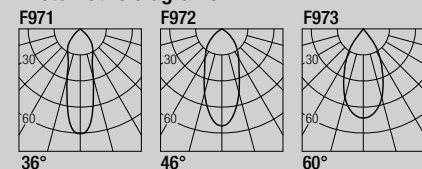

CCT/CRI/Flux

	CRI85	CRI93
2700K	630 lm	590 lm
3000K	700 lm	650 lm
4000K	730 lm	670 lm

CRI85 - CRI93

2-Step MacAdam

Code Construction

Costruzione del codice - Construction du code produit
Bau der Produkt-Code - Construcción del código de producto

TU1 X X X X

Beam angle	S	M	W
Apertura di fascio Angle de faisceau Strahlwinkel Ángulo del haz	36°	46°	60°
CRI	8	9	
	85	93	
Color Temperature	2	3	4
Temperatura colore Température couleur Temperaturabhängige Farbe Temperatura de color	2700K	3000K	4000K
Finishing	1	2	5
Finitura Finitions Oberflächenfinish Acabados	White Bianco Blanc Weiß Blanco	Grey Grigio Gris Grau	Black Nero Noir Schwarz Negro

Accessories

Accessori - Accessoires
Zubehör - Accesorios

STU101

Milky screen
Schermo opale
Écran opale
Opal-Bildschirm
Pantalla opal

Note: the screen must be ordered together with the lighting fixture - **Nota:** lo schermo deve essere ordinato congiuntamente all'apparecchio - **Note:** l'écran doit être commandé en même temps que l'appareil

Anmerkung: muss der Bildschirm zusammen mit Leuchtkörper bestellt werden - **Nota:** la pantalla debe pedirse junta con la luminaria

Drivers

Alimentatori - Alimentateurs
Netzteile - Alimentadores

24 VDC	on/off	dimming module	dimmable
AL2012 (1..3)	60mm IP20	AL7035	AL5012 (1..3)
AL2031 (1..10)	70mm IP20	IP20 PUSH DALI 0/1..10V	45mm IP20 PUSH DALI 0/1..10V
AL2040 (1..21)	80mm IP20		

Note: dimming module AL7035 to be used in combination with an on/off 24VDC power supply
Nota: modulo di dimmerazione AL7035 da utilizzare in combinazione con un alimentatore on/off 24VDC
Note: module de variation AL7035 d'intensité à utiliser en combinaison avec une alimentation on/off 24VDC
Anmerkung: Dimmmodul AL7035 zur Verwendung in Kombination mit einem on/off 24VDC-Netzteil
Nota: módulo de regulación AL7035 se utiliza en combinación con una fuente de alimentación on/off 24VDC



RAÙL 10 UGR

design: Lapo Grassellini

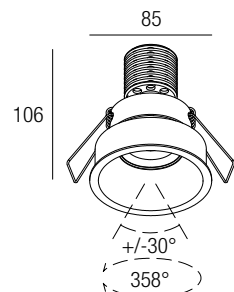

Supply current

Alimentazione
Courant d'alimentation
Stromversorgung
Corriente de alimentación
250 mA (V, 36V)

Power

Potenza
Puissance
Bestuekung
Potencia
10 W



CCT/CRI/Flux

	CRI85	CRI93
2700K	890 lm	840 lm
3000K	1000 lm	930 lm
4000K	1040 lm	960 lm

Photometric diagrams

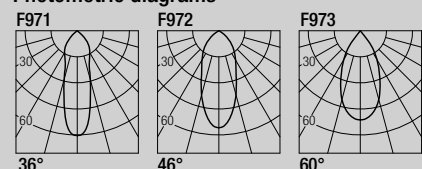

CRI85 - CRI93

2-Step MacAdam

Code Construction

Costruzione del codice - Construction du code produit
Bau der Produkt-Code - Construcción del código de producto

RU1 X X X X

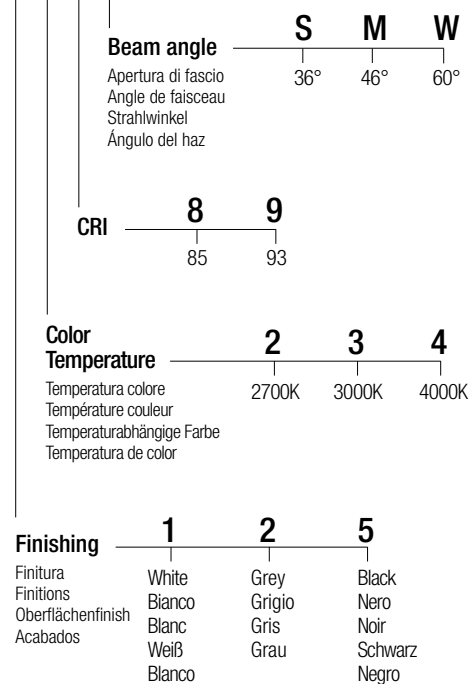

Accessories

Accessori - Accessoires
Zubehör - Accesorios

LOH1 LOH1B LOH1G

White Black Grey
Bianco Nero Grigio
Blanc Noir Gris
Weiß Schwarz Grau
Blanco Negro

Low luminance louver
Filtro antiabbagliamento
Filtre basse luminance
Geringe Leuchtdichte-Filter
Filtro de baja luminancia

SRU101

Milky screen
Schermo opale
Écran opale
Opal-Bildschirm
Pantalla opal

Note: the screen must be ordered together with the lighting fixture - **Nota:** lo schermo deve essere ordinato congiuntamente all'apparecchio - **Note:** l'écran doit être commandé en même temps que l'appareil
Anmerkung: muss der Bildschirm zusammen mit Leuchtkörper bestellt werden - **Nota:** la pantalla debe pedirse junta con la luminaria

Drivers

Alimentatori - Alimentateurs
Netzteile - Alimentadores

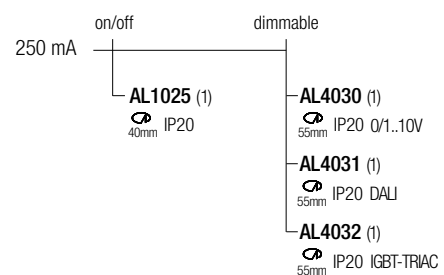

MINE 6

design: Lapo Grassellini

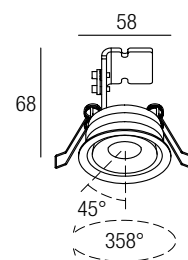

Supply current

Alimentazione
Courant d'alimentation
Stromversorgung
Corriente de alimentación

500 mA (V_i 9V)

Power

Potenza
Puissance
Bestuekung
Potencia

6 W

Series wiring

Cablaggio in serie
Câblage en série
Verkabelung in Serie
Cableado en serie



CCT/CRI/Flux

2700K — 540 lm
3000K — 600 lm
4000K — 620 lm

Photometric diagrams

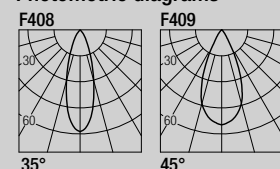

CRI98

2-Step MacAdam

Code Construction

Costruzione del codice - Construction du code produit
Bau der Produkt-Code - Construcción del código de producto

MN6 X X X

Beam angle — S — M
Apertura di fascio — 35° — 45°
Angle de faisceau
Strahlwinkel
Ángulo del haz

Color Temperature — 2 — 3 — 4
Temperatura colore — 2700K — 3000K — 4000K
Température couleur
Temperaturabhängige Farbe
Temperatura de color

Finishing — 1 — 2 — 5
Finitura — White — Grey — Black
Finitions — Bianco — Grigio — Nero
Oberflächenfinish — Blanc — Gris — Noir
Acabados — Weiß — Grau — Schwarz
Blanco — Negro

Accessories

Accessori - Accessoires
Zubehör - Accesorios

SMN601

Milky screen
Schermo opale
Écran opale
Opal-Bildschirm
Pantalla opal

Note: the screen must be ordered together with the lighting fixture - **Nota:** lo schermo deve essere ordinato congiuntamente all'apparecchio - **Note:** l'écran doit être commandé en même temps que l'appareil
Anmerkung: muss der Bildschirm zusammen mit Leuchtkörper bestellt werden - **Nota:** la pantalla debe pedirse junta con la luminaria

AL7022

24VDC/500mA constant current converter
Convertitore 24VDC/500mA corrente costante
Convertisseur 24VDC/500mA courant constant
24VDC/500mA konstanter Strom konverter
Convertidor 24VDC/500mA corriente constante

Drivers

Alimentatori - Alimentateurs
Netzteile - Alimentadores

500 mA	on/off	dimmable
AL1074 (1.2)	30mm IP20	AL4010 (1.4) 72mm IP20 PUSH 0/1..10V
AL1077 (1.2)	40mm IP20	AL4151 (1.4) 72mm IP20 DALI2
AL1084 (1.3)	55mm IP20 S.P.	AL4153 (1.4) 56mm IP20 PUSH IGBT-TRIAC



MINE 10

design: Lapo Grassellini

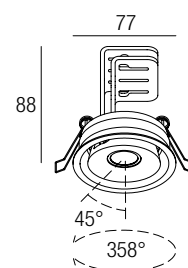

Supply current

Alimentazione
Courant d'alimentation
Stromversorgung
Corriente de alimentación

250 mA (V_i 36V)

Power

Potenza
Pouissance
Bestuekung
Potencia

10 W



Photometric diagrams

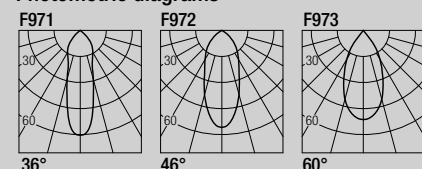

CCT/CRI/Flux

	CRI85	CRI93
2700K	890 lm	840 lm
3000K	1000 lm	930 lm
4000K	1040 lm	960 lm

CRI85 - CRI93
2-Step MacAdam

Code Construction

Costruzione del codice - Construction du code produit
Bau der Produkt-Code - Construcción del código de producto

MN1 X X X X

Beam angle

	S	M	W
Apertura di fascio Angle de faisceau Strahlwinkel Ángulo del haz	36°	46°	60°

CRI

	8	9
	85	93

Color Temperature

	2	3	4
Temperatura colore Température couleur Temperaturabhängige Farbe Temperatura de color	2700K	3000K	4000K

Finishing

	1	2	5
Finitura Finitions Oberflächenfinish Acabados	White Bianco Blanc Weiß Blanco	Grey Grigio Gris Grau	Black Nero Noir Schwarz Negro

Accessories

Accessori - Accessoires
Zubehör - Accesorios

SMN101

Milky screen
Schermo opale
Écran opale
Opal-Bildschirm
Pantalla opal

Note: the screen must be ordered together with the lighting fixture - **Nota:** lo schermo deve essere ordinato congiuntamente all'apparecchio - **Note:** l'écran doit être commandé en même temps que l'appareil
Anmerkung: muss der Bildschirm zusammen mit Leuchtkörper bestellt werden - **Nota:** la pantalla debe pedirse junta con la luminaria

Drivers

Alimentatori - Alimentateurs
Netzteile - Alimentadores

250 mA	on/off	dimmable
AL1025 (1)	40mm IP20	
AL4030 (1)	55mm IP20 0/1..10V	
AL4031 (1)	55mm IP20 DALI	
AL4032 (1)	55mm IP20 IGBT-TRIAC	



MINE 20

design: Lapo Grassellini

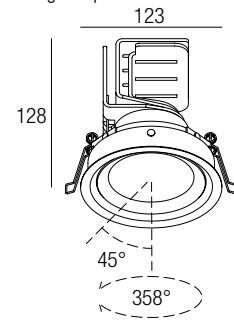

Supply current

Alimentazione
 Courant d'alimentation
 Stromversorgung
 Corriente de alimentación
500 mA (V, 36V)

Power

Potenza
 Pouissance
 Bestuekung
 Potencia
20 W



CCT/CRI/Flux

	CRI85	CRI93
2700K	1830 lm	1700 lm
3000K	2000 lm	1830 lm
4000K	2100 lm	1950 lm

Photometric diagrams

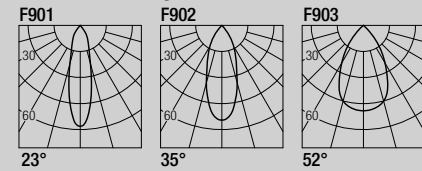

CRI85 - CRI93

2-Step MacAdam

Code Construction

Costruzione del codice - Construction du code produit
 Bau der Produkt-Code - Construcción del código de producto

MN2 X X X X

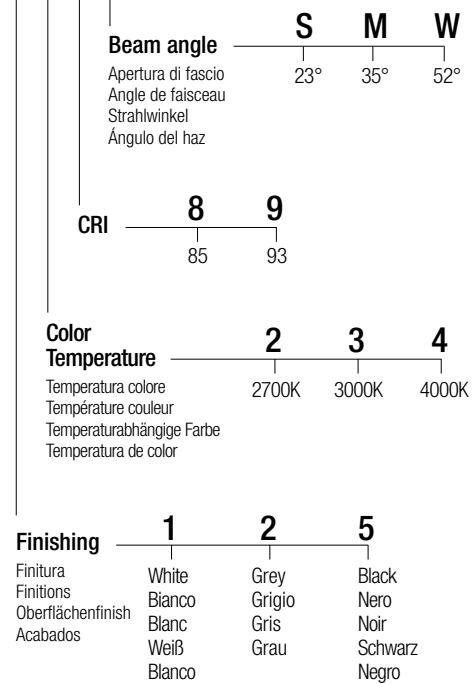

Drivers

Alimentatori - Alimentateurs
 Netzteile - Alimentadores

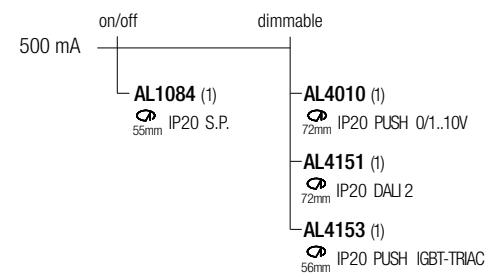

LOLLO 10

design: Lapo Grassellini

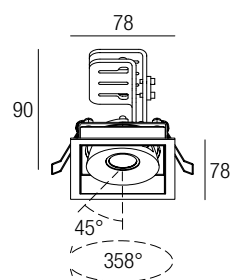

Supply current

Alimentazione
 Courant d'alimentation
 Stromversorgung
 Corriente de alimentación
250 mA (V, 36V)

Power

Potenza
 Pouissance
 Bestuekung
 Potencia
10 W



Photometric diagrams

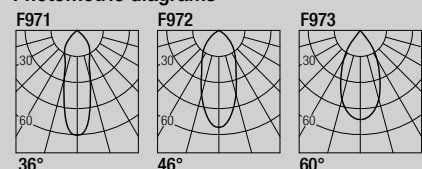

CCT/CRI/Flux

	CRI85	CRI93
2700K	890 lm	840 lm
3000K	1000 lm	930 lm
4000K	1040 lm	960 lm

CRI85 - CRI93
2-Step MacAdam

Code Construction

Costruzione del codice - Construction du code produit
 Bau der Produkt-Code - Construcción del código de producto

LL1 X X X X

Beam angle
 Apertura di fascio
 Angle de faisceau
 Strahlwinkel
 Ángulo del haz

	S	M	W
	36°	46°	60°

CRI

	8	9
	85	93

Color Temperature
 Temperatura colore
 Température couleur
 Temperaturabhängige Farbe
 Temperatura de color

	2	3	4
	2700K	3000K	4000K

Finishing

	1	2	5
Finitura Finitions Oberflächenfinish Acabados	White Bianco Blanc Weiß Blanco	Grey Grigio Gris Grau	Black Nero Noir Schwarz Negro

Accessories

Accessori - Accessoires
 Zubehör - Accesorios

SLL101

Milky screen
 Schermo opale
 Écran opale
 Opal-Bildschirm
 Pantalla opal

Note: the screen must be ordered together with the lighting fixture - **Nota:** lo schermo deve essere ordinato congiuntamente all'apparecchio - **Note:** l'écran doit être commandé en même temps que l'appareil
Anmerkung: muss der Bildschirm zusammen mit Leuchtkörper bestellt werden - **Nota:** la pantalla debe pedirse junta con la luminaria

Drivers

Alimentatori - Alimentateurs
 Netzteile - Alimentadores

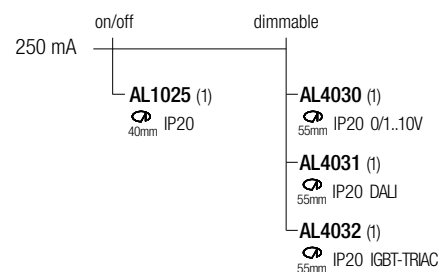

LOLLO X120

design: Lapo Grassellini

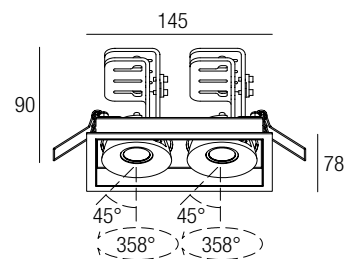

Supply current

Alimentazione
Courant d'alimentation
Stromversorgung
Corriente de alimentación

250 mA (V, 2 x 36V)

Power

Potenza
Puissance
Bestuekung
Potencia

2 x 10 W



Photometric diagrams

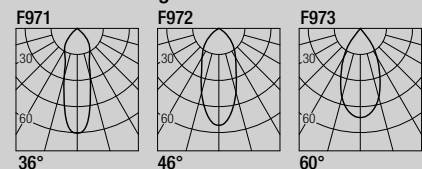

CCT/CRI/Flux

	CRI85	CRI93
2700K	2 x 890 lm	2 x 840 lm
3000K	2 x 1000 lm	2 x 930 lm
4000K	2 x 1040 lm	2 x 960 lm

CRI85 - CRI93

2-Step MacAdam

Code Construction

Costruzione del codice - Construction du code produit
Bau der Produkt-Code - Construcción del código de producto

LLX12 X X X X

Beam angle

	S	M	W
Apertura di fascio	36°	46°	60°
Angle de faisceau	36°	46°	60°
Strahlwinkel	36°	46°	60°
Ángulo del haz	36°	46°	60°

CRI

	8	9
	85	93

Color Temperature

	2	3	4
Temperatura colore	2700K	3000K	4000K
Température couleur	2700K	3000K	4000K
Temperaturabhängige Farbe	2700K	3000K	4000K
Temperatura de color	2700K	3000K	4000K

Finishing

	1	2	5
Finitura	White	Grey	Black
Finitions	Bianco	Grigio	Nero
Oberflächenfinish	Blanc	Gris	Noir
Acabados	Weiß	Grau	Schwarz
	Blanco		Negro

Accessories

Accessori - Accessoires
Zubehör - Accesorios

SLLX1201

(2 pcs)
Milky screen
Schermo opale
Écran opale
Opal-Bildschirm
Pantalla opal

Note: the screen must be ordered together with the lighting fixture - **Nota:** lo schermo deve essere ordinato congiuntamente all'apparecchio - **Note:** l'écran doit être commandé en même temps que l'appareil

Anmerkung: muss der Bildschirm zusammen mit Leuchtkörper bestellt werden - **Nota:** la pantalla debe pedirse junta con la luminaria

Drivers

Alimentatori - Alimentateurs
Netzteile - Alimentadores

Note: each fixture needs 2 drivers

Nota: considerare 2 alimentatori per ogni apparecchio

Note: chaque appareil nécessite 2 alimentateurs

Anmerkung: Jedes Gerät muss 2-Netzteile

Nota: cada luminaria necesita 2 alimentadores

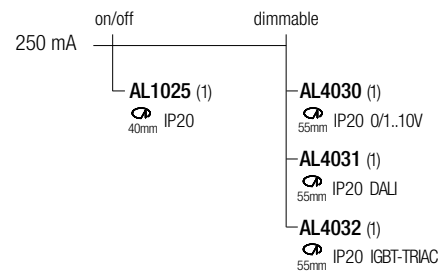

LOLLO X130

design: Lapo Grassellini

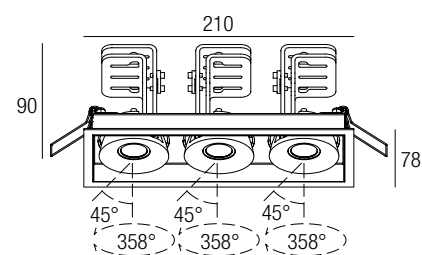

Supply current
 Alimentazione
 Courant d'alimentation
 Stromversorgung
 Corriente de alimentación
250 mA (V, 3 x 36V)

Power
 Potenza
 Pouissance
 Bestuekung
 Potencia
3 x 10 W



Photometric diagrams

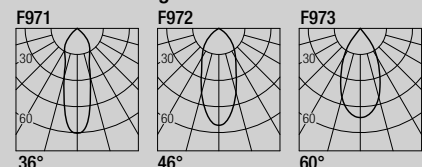

CCT/CRI/Flux

CCT	CRI85	CRI93
2700K	3 x 890 lm	3 x 840 lm
3000K	3 x 1000 lm	3 x 930 lm
4000K	3 x 1040 lm	3 x 960 lm

CRI85 - CRI93
2-Step MacAdam

Code Construction

Costruzione del codice - Construction du code produit
 Bau der Produkt-Code - Construcción del código de producto

LLX13 X X X X

Beam angle

S	M	W
36°	46°	60°

Apertura di fascio
 Angle de faisceau
 Strahlwinkel
 Ángulo del haz

CRI

8	9
85	93

Color Temperature

2	3	4
2700K	3000K	4000K

Temperatura colore
 Température couleur
 Temperaturabhängige Farbe
 Temperatura de color

Finishing

1	2	5
White	Grey	Black
Bianco	Grigio	Nero
Blanc	Gris	Noir
Weiß	Grau	Schwarz
Blanco		Negro

Finitura
 Finitions
 Oberflächenfinish
 Acabados

Accessories

Accessori - Accessoires
 Zubehör - Accesorios

SLLX1301

(3 pcs)
 Milky screen
 Schermo opale
 Écran opale
 Opal-Bildschirm
 Pantalla opal

Note: the screen must be ordered together with the lighting fixture - **Nota:** lo schermo deve essere ordinato congiuntamente all'apparecchio - **Note:** l'écran doit être commandé en même temps que l'appareil
Anmerkung: muss der Bildschirm zusammen mit Leuchtkörper bestellt werden - **Nota:** la pantalla debe pedirse junta con la luminaria

Drivers

Alimentatori - Alimentateurs
 Netzteile - Alimentadores

Note: each fixture needs 3 drivers
Nota: considerare 3 alimentatori per ogni apparecchio
Note: chaque appareil nécessite 3 alimentateurs
Anmerkung: Jedes Gerät muss 3-Netzteile
Nota: cada luminaria necesita 3 alimentadores

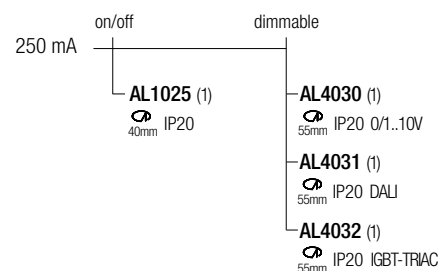

LOLLO 20

design: Lapo Grassellini

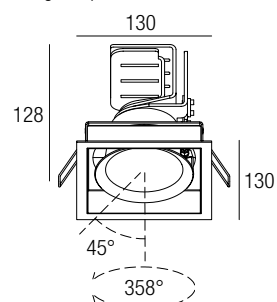

Supply current
 Alimentazione
 Courant d'alimentation
 Stromversorgung
 Corriente de alimentación
500 mA (V, 36V)

Power
 Potenza
 Pouissance
 Bestuekung
 Potencia
20 W



115x115 mm IP20

Photometric diagrams

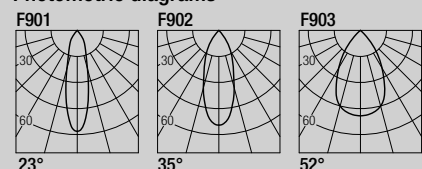

CCT/CRI/Flux

	CRI85	CRI93
2700K	1830 lm	1700 lm
3000K	2000 lm	1830 lm
4000K	2100 lm	1950 lm

CRI85 - CRI93
2-Step MacAdam

Code Construction

Costruzione del codice - Construction du code produit
 Bau der Produkt-Code - Construcción del código de producto

LL2 X X X X

Beam angle
 Apertura di fascio
 Angle de faisceau
 Strahlwinkel
 Ángulo del haz

	S	M	W
	23°	35°	52°

CRI

	8	9
	85	93

Color Temperature
 Temperatura colore
 Température couleur
 Temperaturabhängige Farbe
 Temperatura de color

	2	3	4
	2700K	3000K	4000K

Finishing

	1	2	5
Finitura	White	Grey	Black
Finitions	Bianco	Grigio	Nero
Oberflächenfinish	Blanc	Gris	Noir
Acabados	Weiß	Grau	Schwarz
	Blanco		Negro

Drivers

Alimentatori - Alimentateurs
 Netzteile - Alimentadores

500 mA	on/off	dimnable
	AL1084 (1) 55mm IP20 S.P.	AL4010 (1) 72mm IP20 PUSH 0/1..10V
		AL4151 (1) 72mm IP20 DALI2
		AL4153 (1) 56mm IP20 PUSH IGBT-TRIAC



LOLLO X220

design: Lapo Grassellini

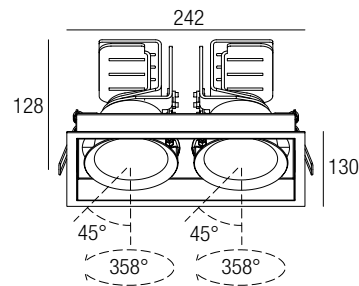

Supply current
Alimentazione
Courant d'alimentation
Stromversorgung
Corriente de alimentación
500 mA (V, 2 x 36V)

Power
Potenza
Puissance
Bestuekung
Potencia
2 x 20 W



Photometric diagrams

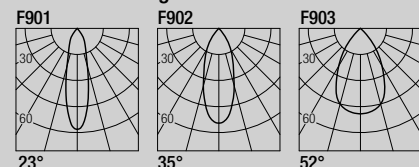

CCT/CRI/Flux

	CRI85	CRI93
2700K	2 x 1830 lm	2 x 1700 lm
3000K	2 x 2000 lm	2 x 1830 lm
4000K	2 x 2100 lm	2 x 1950 lm

CRI85 - CRI93
2-Step MacAdam

Code Construction

Costruzione del codice - Construction du code produit
Bau der Produkt-Code - Construcción del código de producto

LLX22 X X X X

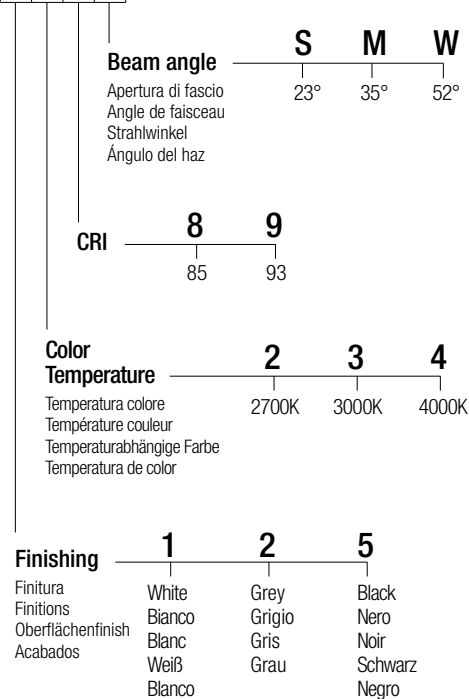

Drivers

Alimentatori - Alimentateurs
Netzteile - Alimentadores
Note: each fixture needs 2 drivers
Nota: considerare 2 alimentatori per ogni apparecchio
Note: chaque appareil nécessite 2 alimentateurs
Anmerkung: Jedes Gerät muss 2-Netzteile
Nota: cada luminaria necesita 2 alimentadores

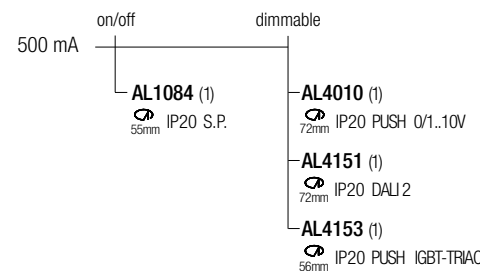

LOLLO X230

design: Lapo Grassellini

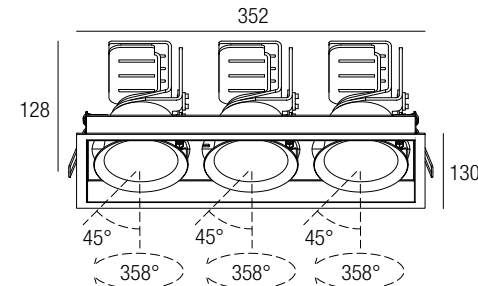

Supply current
Alimentazione
Courant d'alimentation
Stromversorgung
Corriente de alimentación
500 mA (V, 3 x 36V)

Power
Potenza
Puissance
Bestuekung
Potencia
3 x 20 W



Photometric diagrams

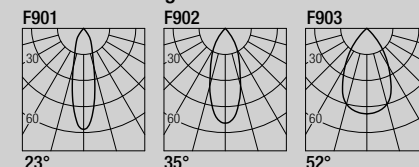

CCT/CRI/Flux

	CRI85	CRI93
2700K	3 x 1830 lm	3 x 1700 lm
3000K	3 x 2000 lm	3 x 1830 lm
4000K	3 x 2100 lm	3 x 1950 lm

CRI85 - CRI93
2-Step MacAdam

Code Construction

Costruzione del codice - Construction du code produit
Bau der Produkt-Code - Construcción del código de producto

LLX23 X X X X

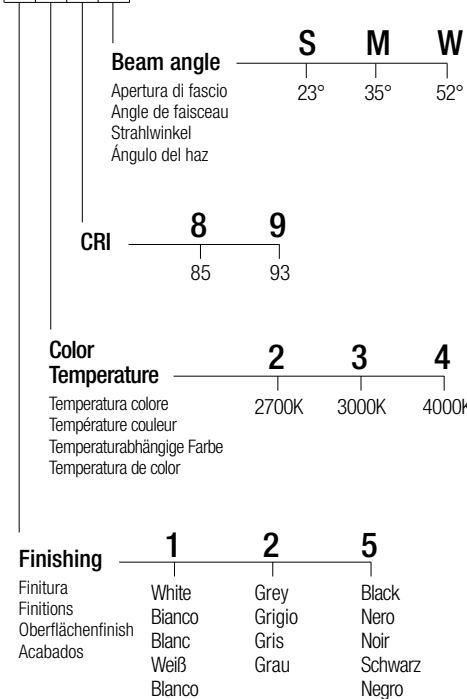

Drivers

Alimentatori - Alimentateurs
Netzteile - Alimentadores
Note: each fixture needs 3 drivers
Nota: considerare 3 alimentatori per ogni apparecchio
Note: chaque appareil nécessite 3 alimentateurs
Anmerkung: Jedes Gerät muss 3-Netzteile
Nota: cada luminaria necesita 3 alimentadores

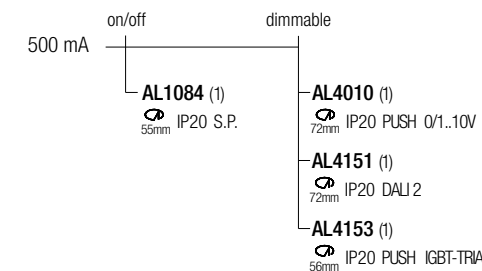

MINILED A R10

design: Lapo Grassellini

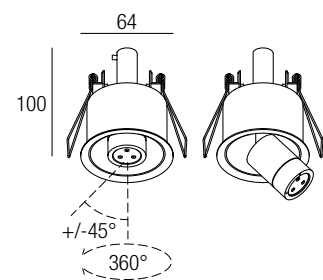

Supply current
 Alimentazione
 Courant d'alimentation
 Stromversorgung
 Corriente de alimentación
350 mA (V, 8, 7V)

Power
 Potenza
 Pouissance
 Bestuekung
 Potencia
3 W

Series wiring
 Cablaggio in serie
 Câblage en série
 Verkabelung in Serie
 Cableado en serie



CCT/CRI/Flux

Photometric diagrams

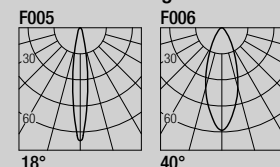

2700K	267 lm
3000K	279 lm
4200K	309 lm
6000K	342 lm

CRI85
2-Step MacAdam

Code Construction

Costruzione del codice - Construction du code produit
 Bau der Produkt-Code - Construcción del código de producto

MLDR X X X

Beam angle — 1 — 2
 Apertura di fascio
 Angle de faisceau
 Strahlwinkel
 Ángulo del haz
 18° 40°

Color Temperature — 0 — 1 — 2 — 3 — 6 — 7 — 8
 Temperatura colore
 Température couleur
 Temperaturabhängige Farbe
 Temperatura de color
 2700K 3000K 4200K 6000K Blue Blu Bleu Blau Azul Green Verde Vert Grün Red Rosso Rouge Rot Rojo

Finishing — 1 — 2 — 5
 Finitura
 Finitions
 Oberflächenfinish
 Acabados
 1 White Bianco Weiß Blanco
 2 Grey Grigio Gris Grau
 5 Black Nero Noir Schwarz Negro

Accessories

Accessori - Accessoires
 Zubehör - Accesorios

AL7021

24VDC/350mA constant current converter
 Convertitore 24VDC/350mA corrente costante
 Convertisseur 24VDC/350mA courant constant
 24VDC/350mA konstanter Strom konverter
 Convertidor 24VDC/350mA corriente constante

Drivers

Alimentatori - Alimentateurs
 Netzteile - Alimentadores

350 mA	on/off	dimmable
AL1034 (1.3) 30mm IP20	AL4000 (1.4) 72mm IP20 PUSH 0/1..10V	
AL1035 (1.3) 40mm IP20	AL4051 (1.4) 72mm IP20 DALI 2	
AL1037 (1.5) 55mm IP20 S.P.	AL4053 (1.4) 56mm IP20 PUSH IGBT-TRIAC	

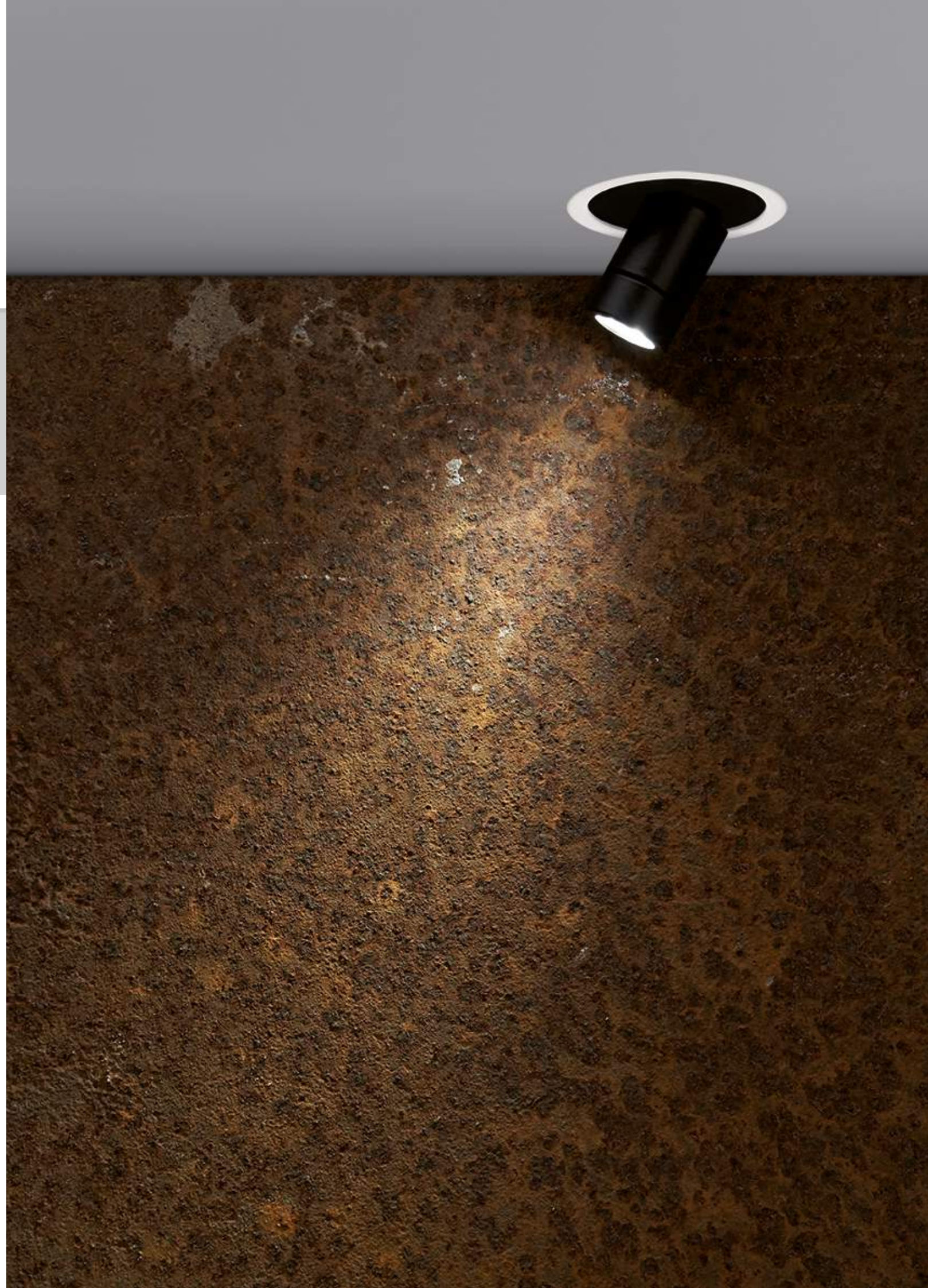

MINILED A Q10

design: Lapo Grassellini

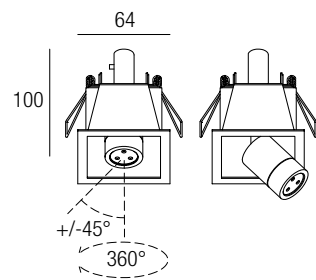

Supply current

Alimentazione
Courant d'alimentation
Stromversorgung
Corriente de alimentación

350 mA (V, 8,7V)

Power

Potenza
Puissance
Bestuekung
Potencia

3 W

Series wiring

Cablaggio in serie
Câblage en série
Verkabelung in Serie
Cableado en serie

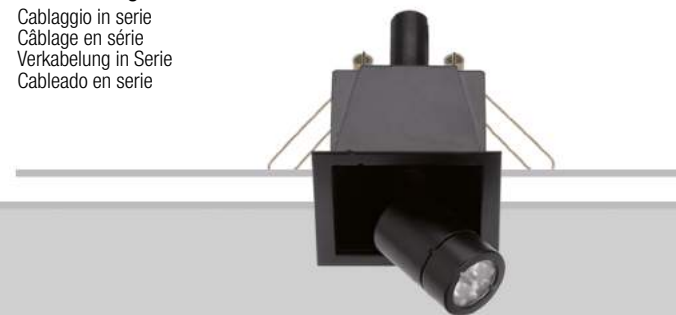

CCT/CRI/Flux

2700K — 267 lm
3000K — 279 lm
4200K — 309 lm
6000K — 342 lm

Photometric diagrams

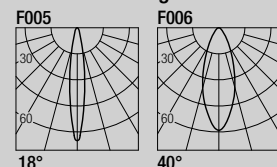

CRI85

2-Step MacAdam

Code Construction

Costruzione del codice - Construction du code produit
Bau der Produkt-Code - Construcción del código de producto

MLDQ X X X

Beam angle — 1 — 2
Apertura di fascio
Angle de faisceau
Strahlwinkel
Ángulo del haz
18° 40°

Color Temperature — 0 — 1 — 2 — 3 — 6 — 7 — 8
Temperatura colore
Température couleur
Temperaturabhängige Farbe
Temperatura de color
0 2700K 1 3000K 2 4200K 3 6000K 6 Blue Blu Bleu Blau Azul 7 Green Verde Vert Grün 8 Red Rosso Rouge Rot Rojo

Finishing — 1 — 2 — 5
Finitura
Finitions
Oberflächenfinish
Acabados
1 White Bianco Blanc Weiß Blanco 2 Grey Grigio Gris Grau 5 Black Nero Noir Schwarz Negro

Accessories

Accessori - Accessoires
Zubehör - Accesorios

AL7021

24VDC/350mA constant current converter
Convertitore 24VDC/350mA corrente costante
Convertisseur 24VDC/350mA courant constant
24VDC/350mA konstanter Strom konverter
Convertidor 24VDC/350mA corriente constante

Drivers

Alimentatori - Alimentateurs
Netzteile - Alimentadores

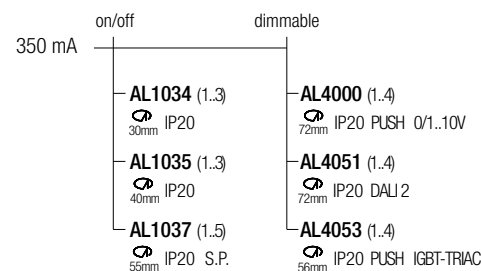

MINILED A QX120

design: Lapo Grassellini

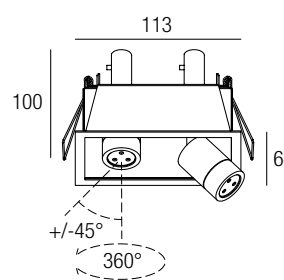

Supply current

Alimentazione
Courant d'alimentation
Stromversorgung
Corriente de alimentación

350 mA (V, 2 x 8,7V)

Power

Potenza
Puissance
Bestuekung
Potencia

2 x 3 W

Series wiring

Cablaggio in serie
Câblage en série
Verkabelung in Serie
Cableado en serie



CCT/CRI/Flux

2700K — 2 x 267 lm
3000K — 2 x 279 lm
4200K — 2 x 309 lm
6000K — 2 x 342 lm

Photometric diagrams

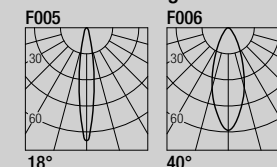

CRI85

2-Step MacAdam

Code Construction

Costruzione del codice - Construction du code produit
Bau der Produkt-Code - Construcción del código de producto

MLDQX12 X X X

Beam angle — 1 — 2
Apertura di fascio
Angle de faisceau
Strahlwinkel
Ángulo del haz
18° 40°

Color Temperature — 0 — 1 — 2 — 3 — 6 — 7 — 8
Temperatura colore
Température couleur
Temperaturabhängige Farbe
Temperatura de color
0 2700K 1 3000K 2 4200K 3 6000K 6 Blue Blu Bleu Blau Azul 7 Green Verde Vert Grün 8 Red Rosso Rouge Rot Rojo

Finishing — 1 — 2 — 5
Finitura
Finitions
Oberflächenfinish
Acabados
1 White Bianco Blanc Weiß Blanco 2 Grey Grigio Gris Grau 5 Black Nero Noir Schwarz Negro

Accessories

Accessori - Accessoires
Zubehör - Accesorios

AL7021

24VDC/350mA constant current converter
Convertitore 24VDC/350mA corrente costante
Convertisseur 24VDC/350mA courant constant
24VDC/350mA konstanter Strom konverter
Convertidor 24VDC/350mA corriente constante

Drivers

Alimentatori - Alimentateurs
Netzteile - Alimentadores

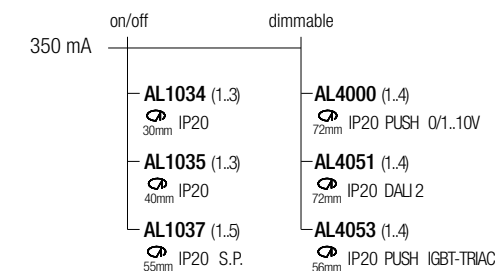

MINILED A QX130

design: Lapo Grassellini

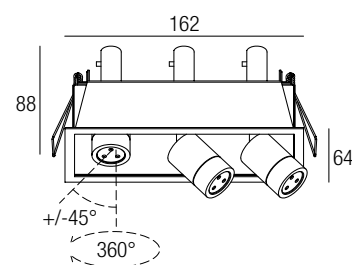

Supply current
 Alimentazione
 Courant d'alimentation
 Stromversorgung
 Corriente de alimentación
350 mA (V_i 3 x 8,7V)

Power
 Potenza
 Pouissance
 Bestuekung
 Potencia
3 x 3 W



Photometric diagrams

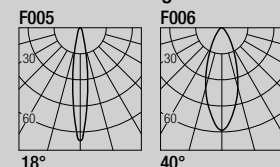

CCT/CRI/Flux

2700K	3 x 267 lm
3000K	3 x 279 lm
4200K	3 x 309 lm
6000K	3 x 342 lm

CRI85
2-Step MacAdam

Code Construction

Costruzione del codice - Construction du code produit
 Bau der Produkt-Code - Construcción del código de producto

MLDQX13 X X X

Beam angle

1	2
18°	40°

Apertura di fascio
 Angle de faisceau
 Strahlwinkel
 Ángulo del haz

Color Temperature

0	1	2	3	6	7	8
2700K	3000K	4200K	6000K	Blue	Green	Red
				Blu	Verde	Rosso
				Bleu	Vert	Rouge
				Blau	Grün	Rot
				Azul		Rojo

Temperatura colore
 Température couleur
 Temperaturabhängige Farbe
 Temperatura de color

Finishing

1	2	5
White	Grey	Black
Bianco	Grigio	Nero
Blanc	Gris	Noir
Weiß	Grau	Schwarz
Blanco		Negro

Finitura
 Finitions
 Oberflächenfinish
 Acabados

Accessories

Accessori - Accessoires
 Zubehör - Accesorios

AL7021

24VDC/350mA constant current converter
 Convertitore 24VDC/350mA corrente costante
 Convertisseur 24VDC/350mA courant constant
 24VDC/350mA konstanter Strom konverter
 Convertidor 24VDC/350mA corriente constante

Drivers

Alimentatori - Alimentateurs
 Netzteile - Alimentadores

350 mA	on/off	dimmable
AL1034 (1.3)	AL4000 (1.4)	
30mm IP20	72mm IP20 PUSH 0/1..10V	
AL1035 (1.3)	AL4051 (1.4)	
40mm IP20	72mm IP20 DALI 2	
AL1037 (1.5)	AL4053 (1.4)	
55mm IP20 S.P.	56mm IP20 PUSH IGBT-TRIAC	

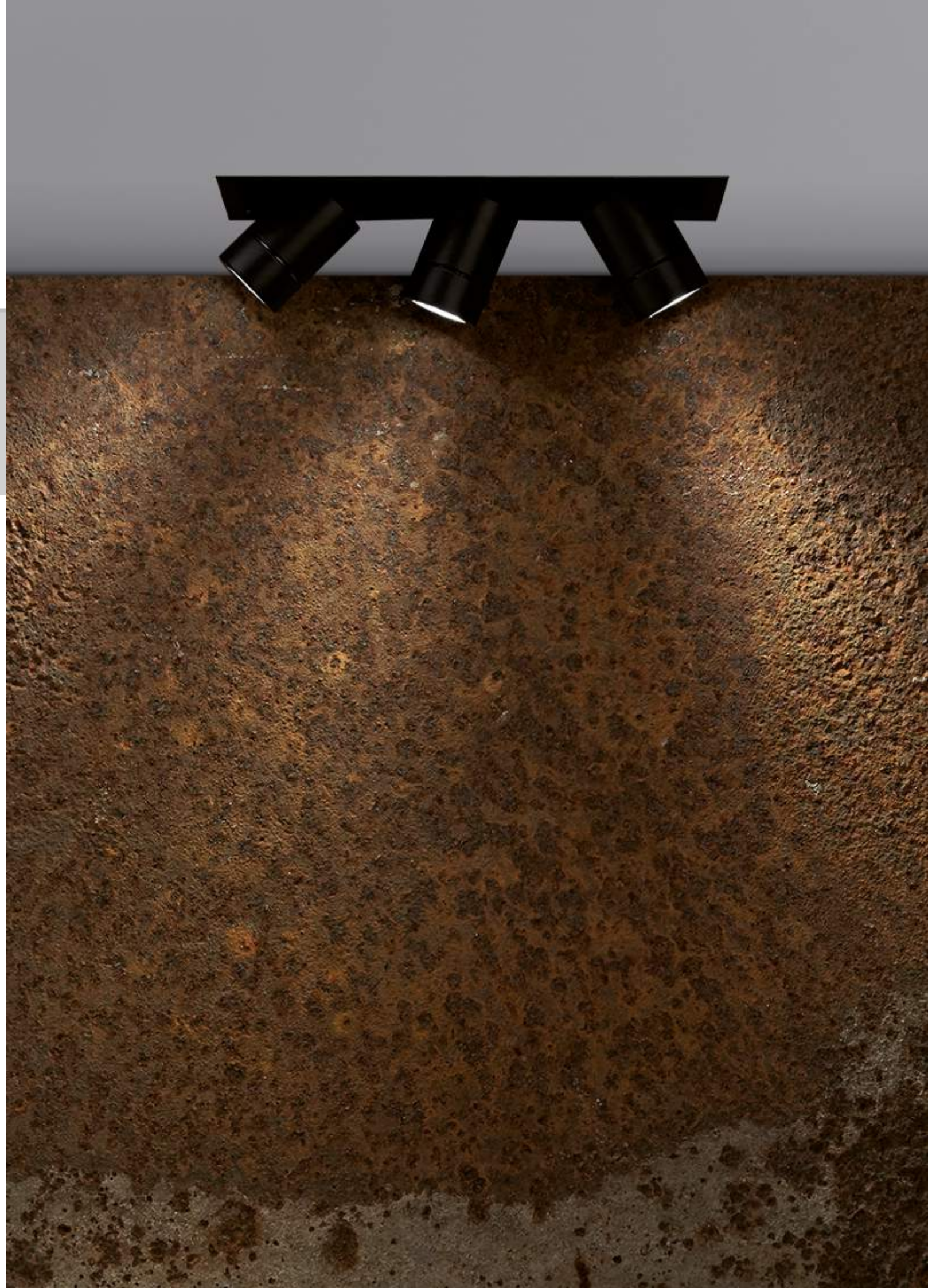

LEDA R10

design: Lapo Grassellini

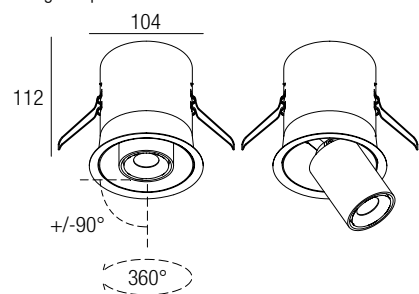

Supply current
 Alimentazione
 Courant d'alimentation
 Stromversorgung
 Corriente de alimentación
250 mA (V, 36V)

Power
 Potenza
 Pouissance
 Bestuekung
 Potencia
10 W



CCT/CRI/Flux

	CRI85	CRI93
2700K	890 lm	840 lm
3000K	1000 lm	930 lm
4000K	1040 lm	960 lm

Photometric diagrams

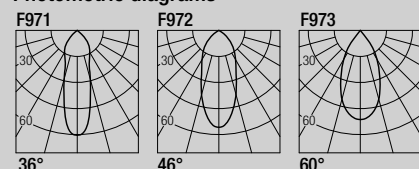

CRI85 - CRI93
2-Step MacAdam

Code Construction

Costruzione del codice - Construction du code produit
 Bau der Produkt-Code - Construcción del código de producto

LDR X X X X

Beam angle

	S	M	W
Apertura di fascio Angle de faisceau Strahlwinkel Ángulo del haz	36°	46°	60°

CRI

	8	9
	85	93

Color Temperature

	2	3	4
Temperatura colore Température couleur Temperaturabhängige Farbe Temperatura de color	2700K	3000K	4000K

Finishing

	1	2	5
Finitura Finitions Oberflächenfinish Acabados	White Bianco Blanc Weiß Blanco	Grey Grigio Gris Grau	Black Nero Noir Schwarz Negro

Accessories

Accessori - Accessoires
 Zubehör - Accesorios

SLDR01

Milky screen
 Schermo opale
 Écran opale
 Opal-Bildschirm
 Pantalla opal

Note: the screen must be ordered together with the lighting fixture - **Nota:** lo schermo deve essere ordinato congiuntamente all'apparecchio - **Note:** l'écran doit être commandé en même temps que l'appareil
Anmerkung: muss der Bildschirm zusammen mit Leuchtkörper bestellt werden - **Nota:** la pantalla debe pedirse junta con la luminaria

Drivers

Alimentatori - Alimentateurs
 Netzteile - Alimentadores

250 mA	on/off	dimmable
	AL1025 (1) 40mm IP20	AL4030 (1) 55mm IP20 0/1..10V
		AL4031 (1) 55mm IP20 DALI
		AL4032 (1) 55mm IP20 IGBT-TRIAC



LEDA Q10

design: Lapo Grassellini

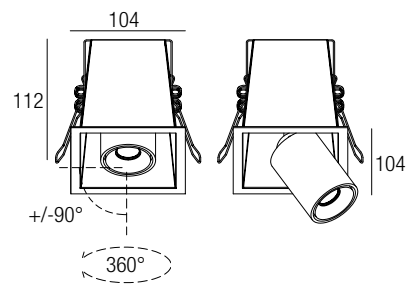

Supply current
 Alimentazione
 Courant d'alimentation
 Stromversorgung
 Corriente de alimentación
250 mA (V, 36V)

Power
 Potenza
 Pouissance
 Bestuekung
 Potencia
10 W



CCT/CRI/Flux

	CRI85	CRI93
2700K	890 lm	840 lm
3000K	1000 lm	930 lm
4000K	1040 lm	960 lm

Photometric diagrams

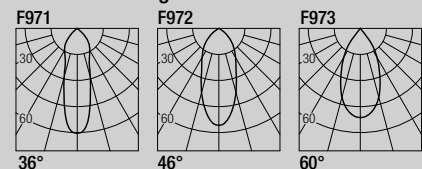

CRI85 - CRI93
2-Step MacAdam

Code Construction

Costruzione del codice - Construction du code produit
 Bau der Produkt-Code - Construcción del código de producto

LDQ X X X X

Beam angle
 Apertura di fascio
 Angle de faisceau
 Strahlwinkel
 Ángulo del haz

	S	M	W
	36°	46°	60°

CRI

	8	9
	85	93

Color Temperature
 Temperatura colore
 Température couleur
 Temperaturabhängige Farbe
 Temperatura de color

	2	3	4
	2700K	3000K	4000K

Finishing

	1	2	5
Finitura	White	Grey	Black
Finitions	Bianco	Grigio	Nero
Oberflächenfinish	Blanc	Gris	Noir
Acabados	Weiß	Grau	Schwarz
	Blanco		Negro

Accessories

Accessori - Accessoires
 Zubehör - Accesorios

SLDQ01

Milky screen
 Schermo opale
 Écran opale
 Opal-Bildschirm
 Pantalla opal

Note: the screen must be ordered together with the lighting fixture - **Nota:** lo schermo deve essere ordinato congiuntamente all'apparecchio - **Note:** l'écran doit être commandé en même temps que l'appareil
Anmerkung: muss der Bildschirm zusammen mit Leuchtkörper bestellt werden - **Nota:** la pantalla debe pedirse junta con la luminaria

Drivers

Alimentatori - Alimentateurs
 Netzteile - Alimentadores

250 mA	on/off	dimmable
	AL1025 (1) 40mm IP20	AL4030 (1) 55mm IP20 0/1..10V
		AL4031 (1) 55mm IP20 DALI
		AL4032 (1) 55mm IP20 IGBT-TRIAC



LEDA QX120

design: Lapo Grassellini

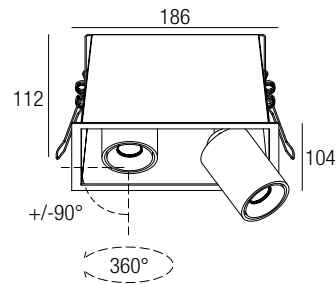

Supply current

Alimentazione
Courant d'alimentation
Stromversorgung
Corriente de alimentación

250 mA (V, 2 x 36V)

Power

Potenza
Puissance
Bestuekung
Potencia

2 x 10 W



Photometric diagrams

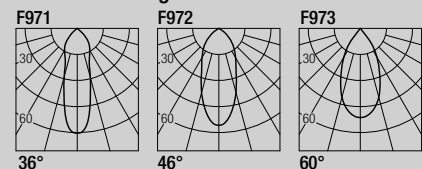

CCT/CRI/Flux

	CRI85	CRI93
2700K	2 x 890 lm	2 x 840 lm
3000K	2 x 1000 lm	2 x 930 lm
4000K	2 x 1040 lm	2 x 960 lm

CRI85 - CRI93
2-Step MacAdam

Code Construction

Costruzione del codice - Construction du code produit
Bau der Produkt-Code - Construcción del código de producto

LDQX12 X X X X

Beam angle

	S	M	W
Apertura di fascio Angle de faisceau Strahlwinkel Angulo del haz	36°	46°	60°

CRI

	8	9
	85	93

Color Temperature

	2	3	4
Temperatura colore Température couleur Temperaturabhängige Farbe Temperatura de color	2700K	3000K	4000K

Finishing

	1	2	5
Finitura Finitions Oberflächenfinish Acabados	White Bianco Blanc Weiß Blanco	Grey Grigio Gris Grau	Black Nero Noir Schwarz Negro

Accessories

Accessori - Accessoires
Zubehör - Accesorios

SLDQX1201

(2 pcs)
Milky screen
Schermo opale
Écran opale
Opal-Bildschirm
Pantalla opal

Note: the screen must be ordered together with the lighting fixture - **Nota:** lo schermo deve essere ordinato congiuntamente all'apparecchio - **Note:** l'écran doit être commandé en même temps que l'appareil
Anmerkung: muss der Bildschirm zusammen mit Leuchtkörper bestellt werden - **Nota:** la pantalla debe pedirse junta con la luminaria

Drivers

Alimentatori - Alimentateurs
Netzteile - Alimentadores

Note: considerare 2 alimentatori per ogni apparecchio
Note: each fixture needs 2 drivers
Note: chaque appareil nécessite 2 alimentateurs
Anmerkung: Jedes Gerät muss 2-Netzteile
Nota: cada luminaria necesita 2 alimentadores

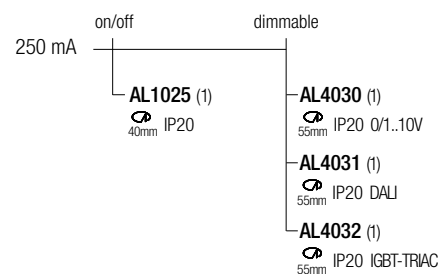

LEDA QX130

design: Lapo Grassellini

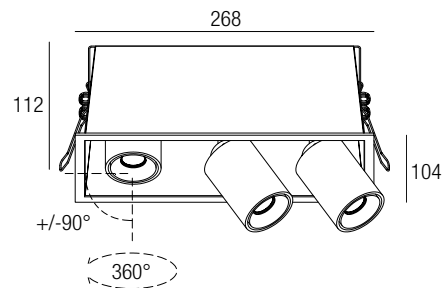

Supply current

Alimentazione
Courant d'alimentation
Stromversorgung
Corriente de alimentación
250 mA (V, 3 x 36V)

Power

Potenza
Puissance
Bestuekung
Potencia
3 x 10 W



Photometric diagrams

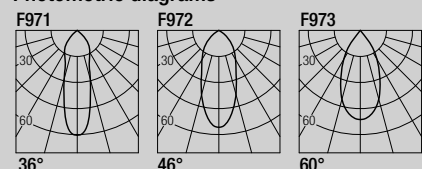

CCT/CRI/Flux

	CRI85	CRI93
2700K	3 x 890 lm	3 x 840 lm
3000K	3 x 1000 lm	3 x 930 lm
4000K	3 x 1040 lm	3 x 960 lm

CRI85 - CRI93

2-Step MacAdam

Code Construction

Costruzione del codice - Construction du code produit
Bau der Produkt-Code - Construcción del código de producto

LDQX13 X X X X

Beam angle	S	M	W
Apertura di fascio Angle de faisceau Strahlwinkel Ángulo del haz	36°	46°	60°

CRI	8	9
	85	93

Color Temperature	2	3	4
Temperatura colore Température couleur Temperaturabhängige Farbe Temperatura de color	2700K	3000K	4000K

Finishing	1	2	5
Finitura Finitions Oberflächenfinish Acabados	White Bianco Blanc Weiß Blanco	Grey Grigio Gris Grau	Black Nero Noir Schwarz Negro

Accessories

Accessori - Accessoires
Zubehör - Accesorios

SLDQX1301

(3 pcs)

Milky screen
Schermo opale
Écran opale
Opal-Bildschirm
Pantalla opal

Note: the screen must be ordered together with the lighting fixture - **Nota:** lo schermo deve essere ordinato congiuntamente all'apparecchio - **Note:** l'écran doit être commandé en même temps que l'appareil
Anmerkung: muss der Bildschirm zusammen mit Leuchtkörper bestellt werden - **Nota:** la pantalla debe pedirse junta con la luminaria

Drivers

Alimentatori - Alimentateurs
Netzteile - Alimentadores

Note: each fixture needs 3 drivers
Nota: considerare 3 alimentatori per ogni apparecchio
Note: chaque appareil nécessite 3 alimentateurs
Anmerkung: Jedes Gerät muss 3-Netzteile
Nota: cada luminaria necesita 3 alimentadores

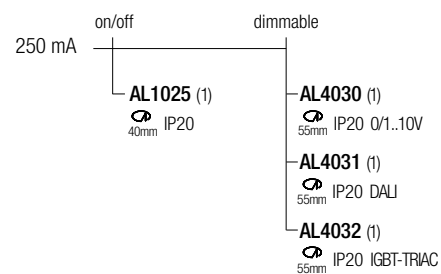

SOREL

design: Roberto Mantovani

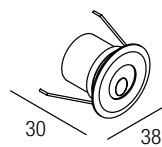

Supply current

Alimentazione
 Courant d'alimentation
 Stromversorgung
 Corriente de alimentación
350-500 mA (V_i 2,9V)

Power

Potenza
 Pouissance
 Bestuekung
 Potencia
1-2 W

Series wiring

Cablaggio in serie
 Câblage en série
 Verkabelung in Serie
 Cableado en serie



CCT/CRI/Flux

	350mA	500mA
2700K	89 lm	128 lm
3000K	93 lm	133 lm
4200K	103 lm	154 lm
6000K	114 lm	165 lm

Photometric diagrams

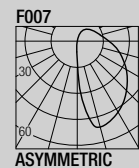

CRI85
2-Step MacAdam



NP1 X 0 X

Color Temperature	0	1	2	3	6	7	8
Temperatura colore	2700K	3000K	4200K	6000K	Blue	Green	Red
Température couleur					Blu	Verde	Rosso
Temperaturabhängige Farbe					Bleu	Vert	Rouge
Temperatura de color					Blau	Grün	Rot
					Azul		Rojo

Finishing	1	2	3	4	5	6	7	9
Finitura	White	Aluminium	Chrome	Gold	Black	Bronze	Titanium	INOX
Finitions	Bianco	Alluminio	Cromo	Oro	Nero	Bronze	Titanio	AISI 316L
Oberflächenfinish	Blanc	Aluminium	Chrom	Or	Noir	Bronce	Titane	Steel
Acabados	Weiß	Aluminio			Schwarz		Titan	Acciaio
	Blanco				Negro			Acier
								Stahl
								Acero

Accessories

Accessori - Accessoires
 Zubehör - Accesorios

CS1001

Recessing box
 Controcassa
 Boîtier d'encastrement
 Eingießegehäuse
 Caja de empotrar

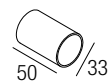

CS1006

Recessing box
 Controcassa
 Boîtier d'encastrement
 Eingießegehäuse
 Caja de empotrar

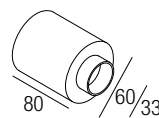

AL7022

24VDC/500mA constant current converter
 Convertitore 24VDC/500mA corrente costante
 Convertisseur 24VDC/500mA courant constant
 24VDC/500mA konstanter Strom konverter
 Convertidor 24VDC/500mA corriente constante

Drivers

Alimentatori - Alimentateurs
 Netzteile - Alimentadores

350 mA		500 mA	
on/off	dimnable	on/off	dimnable
AL1034 (1..11) 30mm IP20	AL4000 (1..12) 72mm IP20 PUSH 0/1..10V	AL1074 (1..7) 30mm IP20	AL4010 (1..12) 72mm IP20 PUSH 0/1..10V
AL1035 (1..11) 40mm IP20	AL4051 (2..14) 72mm IP20 DALI 2	AL1077 (1..6) 40mm IP20	AL4151 (2..14) 72mm IP20 DALI 2
AL1037 (1..16) 55mm IP20 S.P.	AL4053 (1..14) 56mm IP20 PUSH IGBT-TRIAC	AL1084 (1..11) 55mm IP20 S.P.	AL4153 (1..14) 56mm IP20 PUSH IGBT-TRIAC
AL9011 (1..12) 44mm IP67	AL8035 (4..16) IP67 DALI	AL9051 (1..11) 44mm IP67	AL8050 (4..16) IP67 DALI



UMA

design: Roberto Mantovani

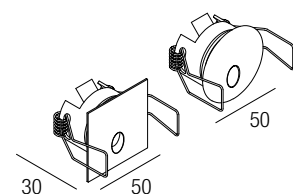

Supply current

Alimentazione
Courant d'alimentation
Stromversorgung
Corriente de alimentación
350 mA (V, 2,9V)

Power

Potenza
Puissance
Bestuekung
Potencia
1 W

Series wiring

Cablaggio in serie
Câblage en série
Verkabelung in Serie
Cableado en serie



Photometric diagrams

F007

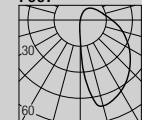

ASMMETRIC

CCT/CRI/Flux

2700K	89 lm
3000K	93 lm
4200K	103 lm
6000K	114 lm

CRI85

2-Step MacAdam



Code Construction

Costruzione del codice - Construction du code produit
Bau der Produkt-Code - Construcción del código de producto

UM X X 2 X

Color Temperature

	0	1	2	3	6	7	8
Temperatura colore	2700K	3000K	4200K	6000K	Blue	Green	Red
Température couleur					Blu	Verte	Rosso
Temperaturabhängige Farbe					Bleu	Vert	Rouge
Temperatura de color					Blau	Grün	Rot
					Azul		Rojo

Finishing

	1	2	3	4	5
Finitura	White	Grey	Chrome	Gold	Black
Finitions	Bianco	Grigio	Cromo	Oro	Nero
Oberflächenfinish	Blanc	Gris	Chrom	Or	Noir
Acabados	Weiß	Grau			Schwarz
	Bianco				Negro

Shape

	1	2
Forma	Round	Square
Forme	Tondo	Quadro
Form	Ronde	Carrè
	Runde	Quadrat
	Redondo	Cuadrado

Accessories

Accessori - Accessoires
Zubehör - Accesorios

CS1005

Recessing box
Controcassa
Boîtier d'encastrement
Eingieβgehäuse
Caja de empotrar

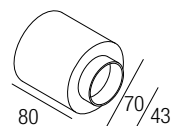

AL7021

24VDC/350mA constant current converter
Convertitore 24VDC/350mA corrente costante
Convertisseur 24VDC/350mA courant constant
24VDC/350mA konstanter Strom konverter
Convertidor 24VDC/350mA corriente constante

Drivers

Alimentatori - Alimentateurs
Netzteile - Alimentadores

350 mA	on/off	dimmable
AL1034 (1..11)	30mm IP20	AL4000 (1..12)
AL1035 (1..11)	40mm IP20	72mm IP20 PUSH 0/1..10V
AL1037 (1..16)	55mm IP20 S.P.	AL4051 (2..14)
		72mm IP20 DALI 2
		AL4053 (1..14)
		56mm IP20 PUSH IGBT-TRIAC



BEAN

design: Roberto Mantovani

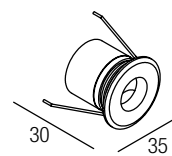

Supply current

Alimentazione
Courant d'alimentation
Stromversorgung
Corriente de alimentación
350 mA (V_i 2,9V)

Power

Potenza
Puissance
Bestuekung
Potencia
1 W

Series wiring

Cablaggio in serie
Câblage en série
Verkabelung in Serie
Cableado en serie



CCT/CRI/Flux

Photometric diagrams

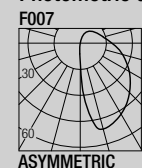

2700K — 101 lm
3000K — 109 lm
4200K — 116 lm
6000K — 132 lm

CRI85
2-Step MacAdam



Code Construction

Costruzione del codice - Construction du code produit
Bau der Produkt-Code - Construcción del código de producto

EA1 X X

Finishing

Finitura
Finitions
Oberflächenfinish
Acabados

	B	G	N	K	Z
White	White	Grey	Black	COR-TEN	INOX AISI 316L
Bianco	Bianco	Grigio	Nero		Steel
Blanc	Blanc	Gris	Noir		Acciaio
Weiß	Weiß	Grau	Schwarz		Acier
Blanco	Blanco		Negro		Stahl
					Acero

Color Temperature

Temperatura colore
Température couleur
Temperaturabhängige Farbe
Temperatura de color

	0	1	2	3	6	7	8
2700K	2700K	3000K	4200K	6000K	Blue	Green	Red
Blu					Blu	Verde	Rosso
Bleu					Bleu	Vert	Rouge
Blau					Blau	Grün	Rot
Azul					Azul		Rojo

Accessories

Accessori - Accessoires
Zubehör - Accesorios

GSLN01

Recessing box
Controcassa
Boîtier d'encastrement
Eingießgehäuse
Caja de empotrar

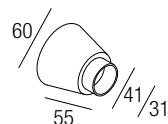

Drivers

Alimentatori - Alimentateurs
Netzteile - Alimentadores

	on/off	dimnable
350 mA		
AL1034 (1.11)		AL4000 (1.12)
30mm IP20		72mm IP20 PUSH 0/1..10V
AL1035 (1.11)		AL4051 (2.14)
40mm IP20		72mm IP20 DALI 2
AL1037 (1.16)		AL4053 (1.14)
55mm IP20 S.P.		56mm IP20 PUSH IGBT-TRIAC
AL9011 (1.12)		AL8035 (4.16)
44mm IP67		IP67 DALI



BANG

design: Roberto Mantovani

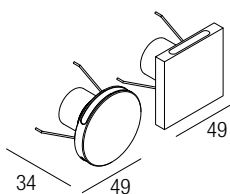

Supply current

Alimentazione
Courant d'alimentation
Stromversorgung
Corriente de alimentación
350-500 mA (V, 2,9V)

Power

Potenza
Pouissance
Bestuekung
Potencia
1-2 W

Series wiring

Cablaggio in serie
Câblage en série
Verkabelung in Serie
Cableado en serie



CCT/CRI/Flux

	350mA	500mA
2700K	89 lm	128 lm
3000K	93 lm	133 lm
4200K	103 lm	154 lm
6000K	114 lm	165 lm

CRI85

2-Step MacAdam



Code Construction

Costruzione del codice - Construction du code produit
Bau der Produkt-Code - Construcción del código de producto

BA | X | X | X | X

Color Temperature

	0	1	2	3	6	7	8
Temperatura colore	2700K	3000K	4200K	6000K	Blue	Green	Red
Température couleur					Blu	Verde	Rosso
Temperaturabhängige Farbe					Bleu	Vert	Rouge
Temperatura de color					Blau	Grün	Rot
					Azul		Rojo

Finishing

	1	2	3	4	5
Finitura	White	Grey	Chrome	Gold	Black
Finitions	Bianco	Grigio	Cromo	Oro	Nero
Oberflächenfinish	Blanc	Gris	Chrom	Or	Noir
Acabados	Weiß	Grau			Schwarz
	Blanco				Negro

Emission

	1	2
Emissione	Single	Double
Émission	Singola	Doppia
	Unique	Doppel
	Einzel	Doble
	Único	

Shape

	1	2
Forma	Round	Square
Forme	Tondo	Quadro
Form	Ronde	Carrè
	Runde	Quadrat
	Redondo	Cuadrado

Accessories

Accessori - Accessoires
Zubehör - Accesorios

CS1006

Recessing box
Controcassa
Boîtier d'encastrement
Eingießgehäuse
Caja de empotrar

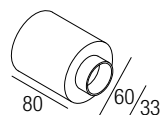

AL7022

24VDC/500mA constant current converter
Convertitore 24VDC/500mA corrente costante
Convertisseur 24VDC/500mA courant constant
24VDC/500mA konstanter Strom konverter
Convertidor 24VDC/500mA corriente constante

Drivers

Alimentatori - Alimentateurs
Netzteile - Alimentadores

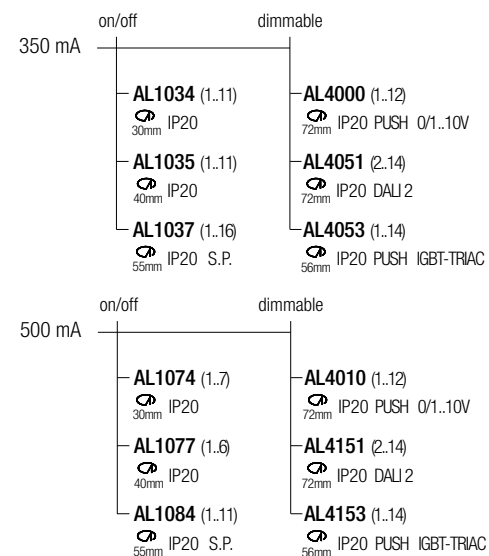

DAGO 2

design: Roberto Mantovani

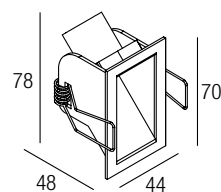

Supply current

Alimentazione
Courant d'alimentation
Stromversorgung
Corriente de alimentación
350-500 mA (V, 2,9V)

Power

Potenza
Puissance
Bestuekung
Potencia
1-2 W

Series wiring

Cablaggio in serie
Câblage en série
Verkabelung in Serie
Cableado en serie



Photometric diagrams

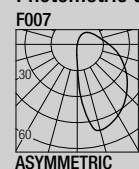

CCT/CRI/Flux

	350mA	500mA
2700K	89 lm	128 lm
3000K	93 lm	133 lm
4200K	103 lm	154 lm
6000K	114 lm	165 lm

CRI85

2-Step MacAdam



Code Construction

Costruzione del codice - Construction du code produit
Bau der Produkt-Code - Construcción del código de producto

DG2 X 2 X

Color Temperature

0	1	2	3	6	7	8
2700K	3000K	4200K	6000K	Blue Blu Bleu Blau Azul	Green Verde Vert Grün	Red Rosso Rouge Rot Rojo

Finishing

1	2	5
White Bianco Blanc Weiß Blanco	Grey Grigio Gris Grau	Black Nero Noir Schwarz Negro

Accessories

Accessori - Accessoires
Zubehör - Accesorios

CS1007

Recessing box
Controcassa
Boîtier d'encastrement
Eingießgehäuse
Caja de empotrar

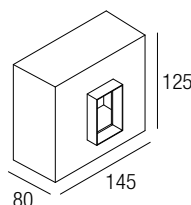

AL7022

24VDC/500mA constant current converter
Convertitore 24VDC/500mA corrente costante
Convertisseur 24VDC/500mA courant constant
24VDC/500mA konstanter Strom konverter
Convertidor 24VDC/500mA corriente constante

Drivers

Alimentatori - Alimentateurs
Netzteile - Alimentadores

350 mA		500 mA	
on/off	dimnable	on/off	dimnable
AL1034 (1..11) 30mm IP20	AL4000 (1..12) 72mm IP20 PUSH 0/1..10V	AL1074 (1..7) 30mm IP20	AL4010 (1..12) 72mm IP20 PUSH 0/1..10V
AL1035 (1..11) 40mm IP20	AL4051 (2..14) 72mm IP20 DALI 2	AL1077 (1..6) 40mm IP20	AL4151 (2..14) 72mm IP20 DALI 2
AL1037 (1..16) 55mm IP20 S.P.	AL4053 (1..14) 55mm IP20 PUSH IGBT-TRIAC	AL1084 (1..11) 55mm IP20 S.P.	AL4153 (1..14) 55mm IP20 PUSH IGBT-TRIAC



DAGO 6

design: Roberto Mantovani

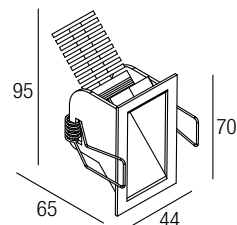

Supply current

Alimentazione
Courant d'alimentation
Stromversorgung
Corriente de alimentación
350-500 mA (V, 8,7V)

Power

Potenza
Puissance
Bestuekung
Potencia
3-6 W

Series wiring

Cablaggio in serie
Câblage en série
Verkabelung in Serie
Cableado en serie



Photometric diagrams

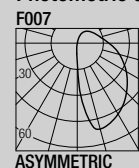

CCT/CRI/Flux

	350mA	500mA
2700K	267 lm	384 lm
3000K	279 lm	400 lm
4200K	309 lm	462 lm
6000K	342 lm	495 lm

CRI85

2-Step MacAdam



Code Construction

Costruzione del codice - Construction du code produit
Bau der Produkt-Code - Construcción del código de producto

Accessories

Accessori - Accessoires
Zubehör - Accesorios

DG6 X 2, X

Color Temperature

0	1	2	3	6	7	8
2700K	3000K	4200K	6000K	Blue	Green	Red
				Bleu	Verte	Rouge
				Blau	Grün	Rot
				Blau	Grün	Rot
				Azul		Rojo

Finishing

1	2	5
White	Grey	Black
Bianco	Grigio	Nero
Blanc	Gris	Noir
Weiß	Grau	Schwarz
Blanco		Negro

CS1007

Recessing box
Controcassa
Boîtier d'encastrement
Eingießgehäuse
Caja de empotrar

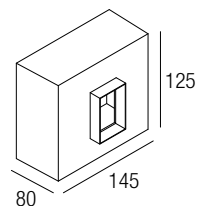

AL7022

24VDC/500mA constant current converter
Convertitore 24VDC/500mA corrente costante
Convertisseur 24VDC/500mA courant constant
24VDC/500mA konstanter Strom konverter
Convertidor 24VDC/500mA corriente constante

Drivers

Alimentatori - Alimentateurs
Netzteile - Alimentadores

350 mA		500 mA	
on/off	dimnable	on/off	dimnable
AL1034 (1..3) 30mm IP20	AL4000 (1..4) 72mm IP20 PUSH 0/1..10V	AL1074 (1..2) 30mm IP20	AL4010 (1..4) 72mm IP20 PUSH 0/1..10V
AL1035 (1..3) 40mm IP20	AL4051 (1..4) 72mm IP20 DALI 2	AL1077 (1..2) 40mm IP20	AL4151 (1..4) 72mm IP20 DALI 2
AL1037 (1..5) 55mm IP20 S.P.	AL4053 (1..4) 56mm IP20 PUSH IGBT-TRIAC	AL1084 (1..3) 55mm IP20 S.P.	AL4153 (1..4) 56mm IP20 PUSH IGBT-TRIAC



KIRSTEN

design: Lapo Grassellini

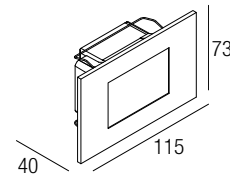

Supply current

Alimentazione
 Courant d'alimentation
 Stromversorgung
 Corriente de alimentación

230 VAC

Power

Potenza
 Pouissance
 Bestuekung
 Potencia

5 W



Photometric diagrams

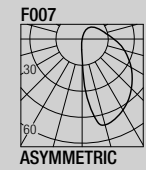

CCT/CRI/Flux

2700K	324 lm
3000K	360 lm
4000K	385 lm

CRI85

2-Step MacAdam



Code Construction

Costruzione del codice - Construction du code produit
 Bau der Produkt-Code - Construcción del código de producto

KR1 X X

Finishing

Finitura
 Finitions
 Oberflächenfinish
 Acabados

B	G	N	K
White Bianco Blanc Weiß Blanco	Grey Grigio Gris Grau	Black Nero Noir Schwarz Negro	COR-TEN

Color Temperature

Temperatura colore
 Température couleur
 Temperaturabhängige Farbe
 Temperatura de color

2	3	4
2700K	3000K	4000K

Accessories

Accessori - Accessoires
 Zubehör - Accesorios

FXC503

Recessing box
 Controcassa
 Boîtier d'encastrement
 Eingießgehäuse
 Caja de empotrar

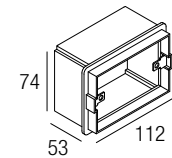

BRAD

design: Lapo Grassellini

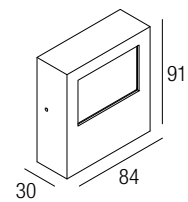

Supply current

Alimentazione
Courant d'alimentation
Stromversorgung
Corriente de alimentación

230 VAC

Power

Potenza
Puissance
Bestuekung
Potencia

5 W



CCT/CRI/Flux

Photometric diagrams

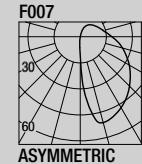

2700K — 324 lm
3000K — 360 lm
4000K — 385 lm

CRI85
2-Step MacAdam



Code Construction

Costruzione del codice - Construction du code produit
Bau der Produkt-Code - Construcción del código de producto

BD1 X X

Finishing

	B	G	N	K
Finitura	White	Grey	Black	COR-TEN
Finitions	Bianco	Grigio	Nero	
Oberflächenfinish	Blanc	Gris	Noir	
Acabados	Weiß	Grau	Schwarz	
	Blanco		Negro	

Color Temperature

	2	3	4
Temperatura colore	2700K	3000K	4000K
Température couleur			
Temperaturabhängige Farbe			
Temperatura de color			



MINIJOS F2

design: Roberto Mantovani

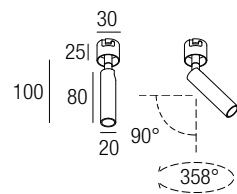

Supply current

Alimentazione
Courant d'alimentation
Stromversorgung
Corriente de alimentación

500 mA (V_i 2,9V)

Power

Potenza
Puissance
Bestuekung
Potencia

2 W

Series wiring

Cablaggio in serie
Câblage en série
Verkabelung in Serie
Cableado en serie



CCT/CRI/Flux

Photometric diagrams

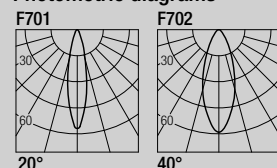

2700K — 128 lm
3000K — 133 lm
4200K — 154 lm

CRI85

2-Step MacAdam

Code Construction

Costruzione del codice - Construction du code produit
Bau der Produkt-Code - Construcción del código de producto

MJSF2 X X X

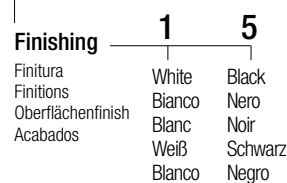
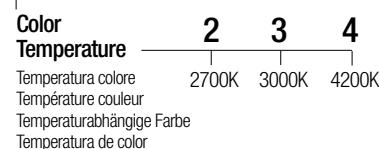
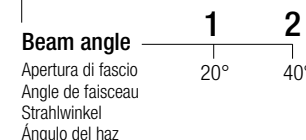

Drivers

Alimentatori - Alimentateurs
Netzteile - Alimentadores

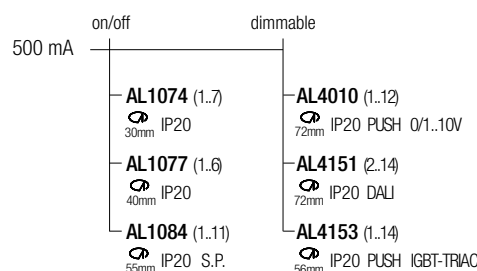

MINIJOS F6

design: Roberto Mantovani

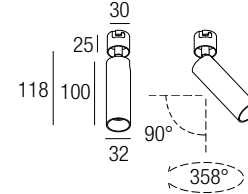

Supply current

Alimentazione
Courant d'alimentation
Stromversorgung
Corriente de alimentación

500 mA (V_i 9V)

Power

Potenza
Puissance
Bestuekung
Potencia

6 W

Series wiring

Cablaggio in serie
Câblage en série
Verkabelung in Serie
Cableado en serie



CCT/CRI/Flux

Photometric diagrams

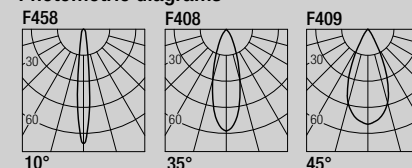

2700K — 540 lm
3000K — 600 lm
4000K — 620 lm

CRI98

2-Step MacAdam

Code Construction

Costruzione del codice - Construction du code produit
Bau der Produkt-Code - Construcción del código de producto

MJSF6 X X X

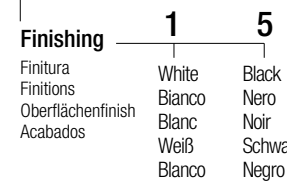
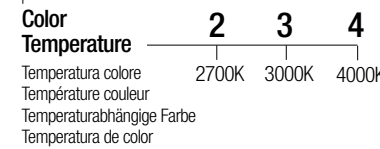
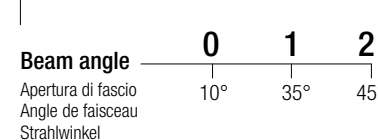

Drivers

Alimentatori - Alimentateurs
Netzteile - Alimentadores

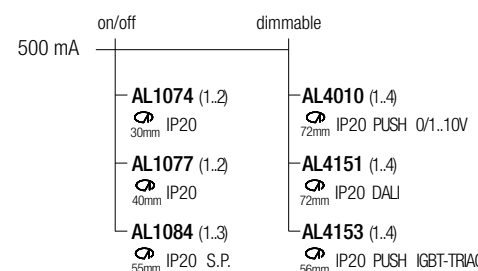

Accessories

Accessori - Accessoires
Zubehör - Accesorios

ZQC001 ZQC001B

White Black
Bianco Nero
Blanc Noir
Weiß Schwarz
Blanco Negro

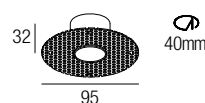

Plasterboard recessing frame
Flangia per cartongesso
Boîtier d'encastrement pour plaques de plâtre
Gehäuses Trockenbau
Cajetín para placas de yeso

AL7022

24VDC/500mA constant current converter
Convertitore 24VDC/500mA corrente costante
Convertisseur 24VDC/500mA courant constant
24VDC/500mA konstanter Strom konverter
Convertidor 24VDC/500mA corriente constante

Note: versions with extended arm length are available upon request **Nota:** versioni con lunghezza del braccetto maggiorata disponibili su richiesta **Note:** versions avec longueur du bras majorée disponibles sur demande **Anmerkung:** versionen mit erhöhter Armlänge auf Anfrage erhältlich **Nota:** Versiones con longitud del brazo aumentada disponible bajo pedido

Accessories

Accessori - Accessoires
Zubehör - Accesorios

ZQC001 ZQC001B

White Black
Bianco Nero
Blanc Noir
Weiß Schwarz
Blanco Negro

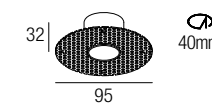

Plasterboard recessing frame
Flangia per cartongesso
Boîtier d'encastrement pour plaques de plâtre
Gehäuses Trockenbau
Cajetín para placas de yeso

LJ02

White
Bianco
Blanc
Weiß
Blanco

LJ02B

Black
Nero
Noir
Schwarz
Negro

Low luminance louver
Filtro antiabbagliamento
Filtre basse luminance
Geringe Leuchtdichte-Filter
Filtro de baja luminancia



SJ02

White
Bianco
Blanc
Weiß
Blanco

SJ02B

Black
Nero
Noir
Schwarz
Negro

Milky screen
Schermo opale
Écran opale
Opal-Bildschirm
Pantalla opal



AL7022

24VDC/500mA constant current converter
Convertitore 24VDC/500mA corrente costante
Convertisseur 24VDC/500mA courant constant
24VDC/500mA konstanter Strom konverter
Convertidor 24VDC/500mA corriente constante

Note: versions with extended arm length are available upon request **Nota:** versioni con lunghezza del braccetto maggiorata disponibili su richiesta **Note:** versions avec longueur du bras majorée disponibles sur demande **Anmerkung:** versionen mit erhöhter Armlänge auf Anfrage erhältlich **Nota:** Versiones con longitud del brazo aumentada disponible bajo pedido

MINIJOS F10

design: Roberto Mantovani

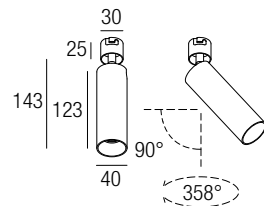

Supply current

Alimentazione
Courant d'alimentation
Stromversorgung
Corriente de alimentación

500 mA (V_i 18V)

Power

Potenza
Puissance
Bestuekung
Potencia

10 W

Series wiring

Cablaggio in serie
Câblage en série
Verkabelung in Serie
Cableado en serie



Photometric diagrams

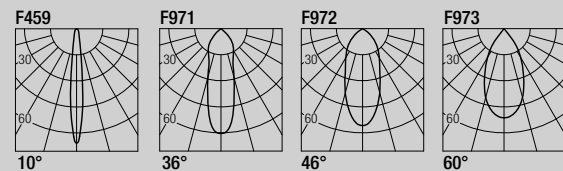

CCT/CRI/Flux

	CRI85	CRI93
2700K	890lm	840lm
3000K	1000lm	930lm
4000K	1040lm	960lm

CRI85-93

2-Step MacAdam



Code Construction

Costruzione del codice - Construction du code produit
Bau der Produkt-Code - Construcción del código de producto

MJSF1 X X X X

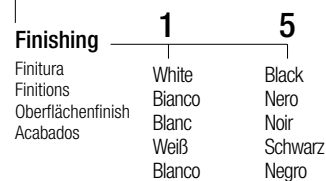
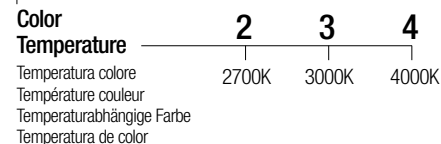
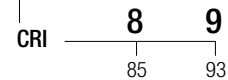
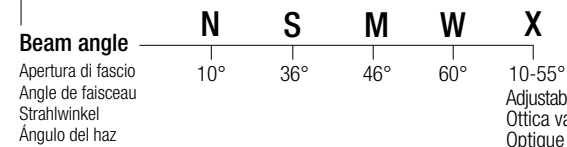

Accessories

Accessori - Accessoires
Zubehör - Accesorios

ZQC001 ZQC001B

White
Bianco
Blanc
Weiß
Blanco

Black
Nero
Noir
Schwarz
Negro

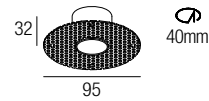

Plasterboard recessing frame
Flangia per cartongesso
Boîtier d'encastrement pour plaques de plâtre
Gehäuses Trockenbau
Cajetín para placas de yeso

LJ01 LJ01B

White
Bianco
Blanc
Weiß
Blanco

Black
Nero
Noir
Schwarz
Negro

SJ01 SJ01B

White
Bianco
Blanc
Weiß
Blanco

Black
Nero
Noir
Schwarz
Negro

Low luminance louver
Filtro antiabbagliamento
Filtre basse luminance
Geringe Leuchtdichte-Filter
Filtro de baja luminancia

Milky screen
Schermo opale
Écran opale
Opal-Bildschirm
Pantalla opal

AL7022

24VDC/500mA constant current converter
Convertitore 24VDC/500mA corrente costante
Convertisseur 24VDC/500mA courant constant
24VDC/500mA konstanter Strom konverter
Convertidor 24VDC/500mA corriente constante

Note: versions with extended arm length are available upon request **Nota:** versioni con lunghezza del braccetto maggiorata disponibili su richiesta **Note:** versions avec longueur du bras majorée disponibles sur demande **Anmerkung:** versionen mit erhöhter Armlänge auf Anfrage erhältlich **Nota:** Versiones con longitud del brazo aumentada disponible bajo pedido

Drivers

Alimentatori - Alimentateurs
Netzteile - Alimentadores

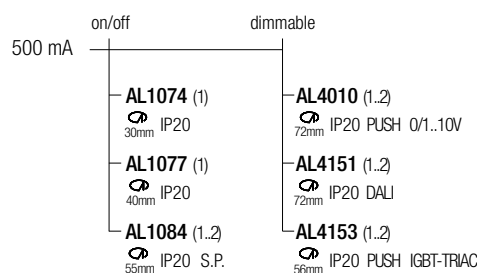

JOS F2

design: Roberto Mantovani

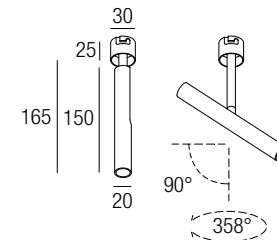

Supply current

Alimentazione
Courant d'alimentation
Stromversorgung
Corriente de alimentación

500 mA (V_i 2,9V)

Power

Potenza
Puissance
Bestuekung
Potencia

2 W

Series wiring

Cablaggio in serie
Câblage en série
Verkabelung in Serie
Cableado en serie



Photometric diagrams

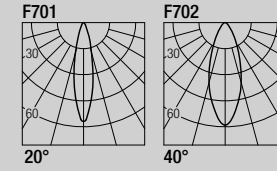

CCT/CRI/Flux

2700K	128 lm
3000K	133 lm
4200K	154 lm

CRI85

2-Step MacAdam



Code Construction

Costruzione del codice - Construction du code produit
Bau der Produkt-Code - Construcción del código de producto

JSF2 X X X

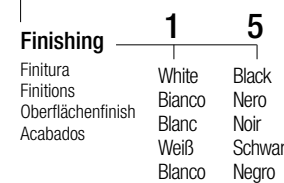
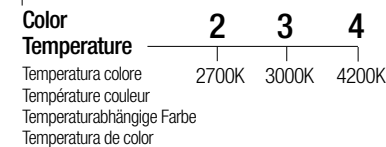
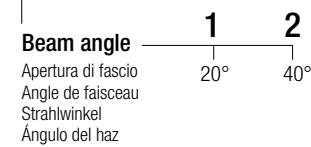

Accessories

Accessori - Accessoires
Zubehör - Accesorios

ZQC001 ZQC001B

White
Bianco
Blanc
Weiß
Blanco

Black
Nero
Noir
Schwarz
Negro

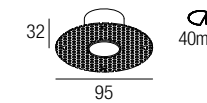

Plasterboard recessing frame
Flangia per cartongesso
Boîtier d'encastrement pour plaques de plâtre
Gehäuses Trockenbau
Cajetín para placas de yeso

AL7022

24VDC/500mA constant current converter
Convertitore 24VDC/500mA corrente costante
Convertisseur 24VDC/500mA courant constant
24VDC/500mA konstanter Strom konverter
Convertidor 24VDC/500mA corriente constante

Note: versions with extended arm length are available upon request **Nota:** versioni con lunghezza del braccetto maggiorata disponibili su richiesta **Note:** versions avec longueur du bras majorée disponibles sur demande **Anmerkung:** versionen mit erhöhter Armlänge auf Anfrage erhältlich **Nota:** Versiones con longitud del brazo aumentada disponible bajo pedido

Drivers

Alimentatori - Alimentateurs
Netzteile - Alimentadores

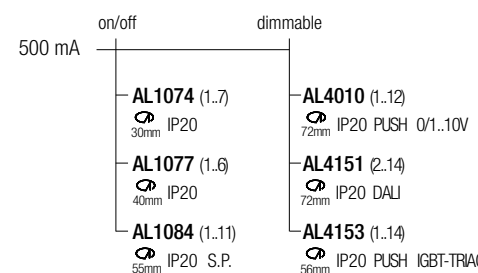

JOS F6

design: Roberto Mantovani

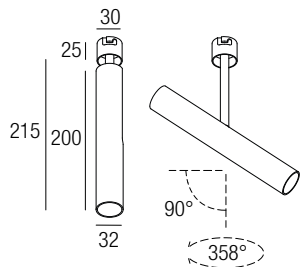

Supply current

Alimentazione
Courant d'alimentation
Stromversorgung
Corriente de alimentación
500 mA (V_i 9V)

Power

Potenza
Puissance
Bestuekung
Potencia
6 W

Series wiring

Cablaggio in serie
Câblage en série
Verkabelung in Serie
Cableado en serie



Photometric diagrams

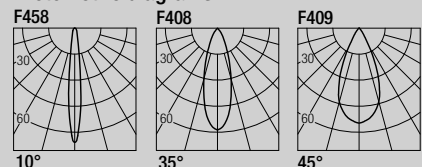

CCT/CRI/Flux

2700K — **540 lm**
3000K — **600 lm**
4000K — **620 lm**

CRI98
2-Step MacAdam



JOS F10

design: Roberto Mantovani

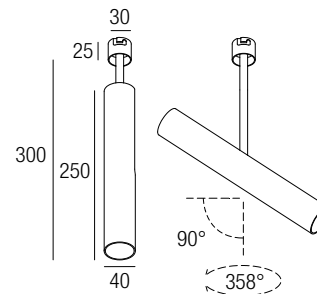

Supply current

Alimentazione
Courant d'alimentation
Stromversorgung
Corriente de alimentación
500 mA (V_i 18V)

Power

Potenza
Puissance
Bestuekung
Potencia
10 W

Series wiring

Cablaggio in serie
Câblage en série
Verkabelung in Serie
Cableado en serie



Photometric diagrams

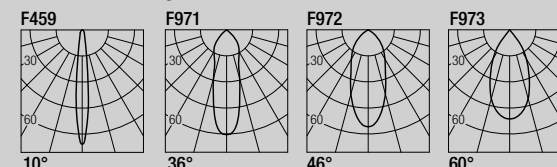

CCT/CRI/Flux

CRI85 CRI93
2700K — 890lm 840lm
3000K — 1000lm 930lm
4000K — 1040lm 960lm

CRI85-93
2-Step MacAdam



Code Construction

Costruzione del codice - Construction du code produit
Bau der Produkt-Code - Construcción del código de producto

JSF6 X X X X

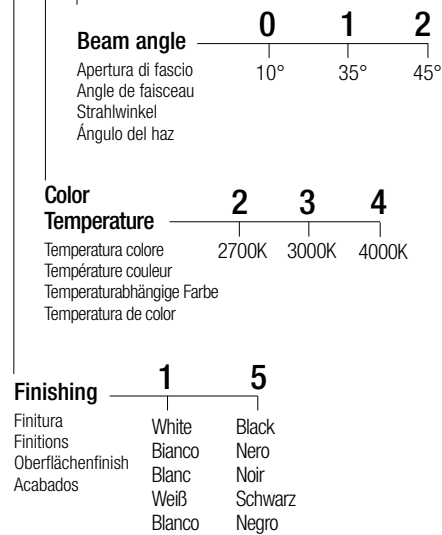

Accessories

Accessori - Accessoires
Zubehör - Accesorios

ZQC001 ZQC001B

White Bianco
Blanco Negro
Blanc Noir
Weiß Schwarz
Blanco Negro

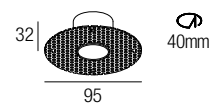

Plasterboard recessing frame
Flangia per cartongesso
Boîtier d'encastrement pour plaques de plâtre
Gehäuses Trockenbau
Cajetín para placas de yeso

LJ02

White Bianco
Blanco Negro
Blanc Noir
Weiß Schwarz
Blanco Negro

Low luminance louver
Filtro antiabbagliamento
Filtre basse luminance
Geringe Leuchtdichte-Filter
Filtro de baja luminancia

LJ02B

Black Nero
Noir Schwarz
Schwarz Negro



Milky screen
Schermo opale
Écran opale
Opal-Bildschirm
Pantalla opal

Note: the filter and the screen are not available in adjustable optics version 10-55° - **Nota:** il filtro e lo schermo non sono disponibili nella versione ad ottica regolabile 10-55° - **Note:** le filtre et l'écran ne sont pas disponibles dans la version à optique réglable 10-55° - **Anmerkung:** Filter und Bildschirm sind in der einstellbaren optischen Version 10-55° nicht verfügbar - **Nota:** el filtro y la pantalla no están disponibles en la versión de óptica ajustable 10-55°

AL7022

24VDC/500mA constant current converter
Convertitore 24VDC/500mA corrente costante
Convertisseur 24VDC/500mA courant constant
24VDC/500mA konstanter Strom konverter
Convertidor 24VDC/500mA corriente constante

Note: versions with extended arm length are available upon request **Nota:** versioni con lunghezza del braccetto maggiorata disponibili su richiesta **Note:** versions avec longueur du bras majorée disponibles sur demande **Anmerkung:** versionen mit erhöhter Armlänge auf Anfrage erhältlich **Nota:** Versiones con longitud del brazo aumentada disponible bajo pedido

Code Construction

Costruzione del codice - Construction du code produit
Bau der Produkt-Code - Construcción del código de producto

JSF1 X X X X

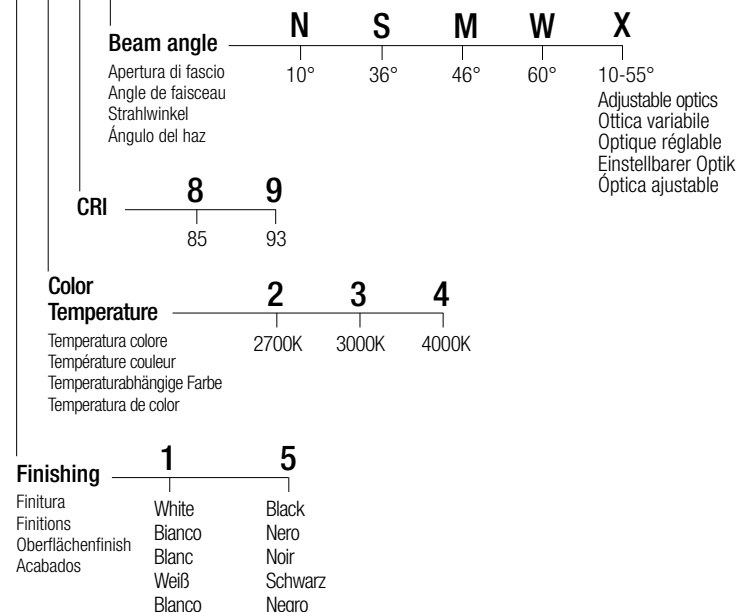

Drivers

Alimentatori - Alimentateurs
Netzteile - Alimentadores

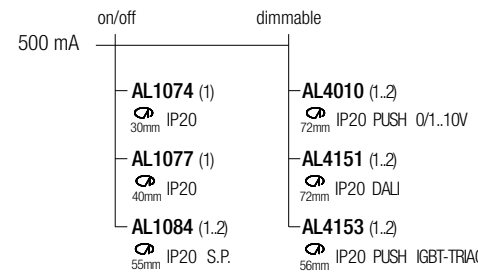

Accessories

Accessori - Accessoires
Zubehör - Accesorios

ZQC001 ZQC001B

White Bianco
Blanco Negro
Blanc Noir
Weiß Schwarz
Blanco Negro

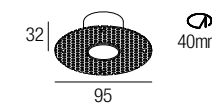

Plasterboard recessing frame
Flangia per cartongesso
Boîtier d'encastrement pour plaques de plâtre
Gehäuses Trockenbau
Cajetín para placas de yeso

LJ01

White Bianco
Blanco Negro
Blanc Noir
Weiß Schwarz
Blanco Negro

Low luminance louver
Filtro antiabbagliamento
Filtre basse luminance
Geringe Leuchtdichte-Filter
Filtro de baja luminancia

LJ01B

Black Nero
Noir Schwarz
Schwarz Negro

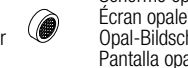

Milky screen
Schermo opale
Écran opale
Opal-Bildschirm
Pantalla opal

Note: the filter and the screen are not available in adjustable optics version 10-55° - **Nota:** il filtro e lo schermo non sono disponibili nella versione ad ottica regolabile 10-55° - **Note:** le filtre et l'écran ne sont pas disponibles dans la version à optique réglable 10-55° - **Anmerkung:** Filter und Bildschirm sind in der einstellbaren optischen Version 10-55° nicht verfügbar - **Nota:** el filtro y la pantalla no están disponibles en la versión de óptica ajustable 10-55°

AL7022

24VDC/500mA constant current converter
Convertitore 24VDC/500mA corrente costante
Convertisseur 24VDC/500mA courant constant
24VDC/500mA konstanter Strom konverter
Convertidor 24VDC/500mA corriente constante

Note: versions with extended arm length are available upon request **Nota:** versioni con lunghezza del braccetto maggiorata disponibili su richiesta **Note:** versions avec longueur du bras majorée disponibles sur demande **Anmerkung:** versionen mit erhöhter Armlänge auf Anfrage erhältlich **Nota:** Versiones con longitud del brazo aumentada disponible bajo pedido

LAD F6

design: Roberto Mantovani

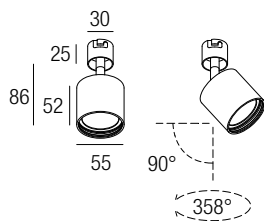

Supply current

Alimentazione
 Courant d'alimentation
 Stromversorgung
 Corriente de alimentación
500 mA (V, 9V)

Power

Potenza
 Pouissance
 Bestuekung
 Potencia
6 W

Series wiring

Cablaggio in serie
 Câblage en série
 Verkabelung in Serie
 Cableado en serie



Photometric diagrams

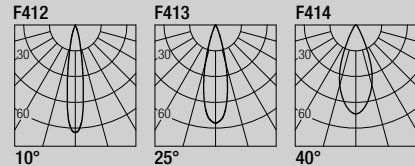

CCT/CRI/Flux

2700K — 540 lm
 3000K — 600 lm
 4000K — 620 lm

CRI98
 2-Step MacAdam



Code Construction

Costruzione del codice - Construction du code produit
 Bau der Produkt-Code - Construcción del código de producto

LADF6 X X X

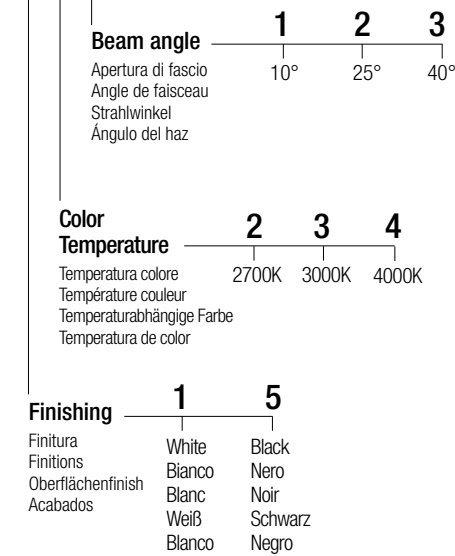

Accessories

Accessori - Accessoires
 Zubehör - Accesorios

ZQC001 ZQC001B

White Black
 Bianco Nero
 Blanc Noir
 Weiß Schwarz
 Blanco Negro

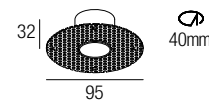

Plasterboard recessing frame
 Flangia per cartongesso
 Boîtier d'encastrement pour plaques de plâtre
 Gehäuses Trockenbau
 Cajetín para placas de yeso

LL02 LL02B

White Black
 Bianco Nero
 Blanc Noir
 Weiß Schwarz
 Blanco Negro

SL02 SL02B

White Black
 Bianco Nero
 Blanc Noir
 Weiß Schwarz
 Blanco Negro

Low luminance louver
 Filtro antiabbagliamento
 Filtre basse luminance
 Geringe Leuchtdichte-Filter
 Filtro de baja luminancia

Milky screen
 Schermo opale
 Écran opale
 Opal-Bildschirm
 Pantalla opal

AL7022

24VDC/500mA constant current converter
 Convertitore 24VDC/500mA corrente costante
 Convertisseur 24VDC/500mA courant constant
 24VDC/500mA konstanter Strom konverter
 Convertidor 24VDC/500mA corriente constante

Note: versions with extended arm length are available upon request **Nota:** versioni con lunghezza del braccetto maggiorata disponibili su richiesta **Note:** versions avec longueur du bras majorée disponibles sur demande **Anmerkung:** versionen mit erhöhter Armlänge auf Anfrage erhältlich **Nota:** Versiones con longitud del brazo aumentada disponible bajo pedido

Drivers

Alimentatori - Alimentateurs
 Netzteile - Alimentadores

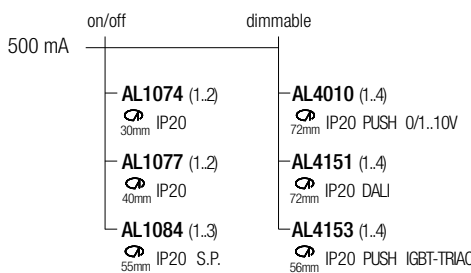

LAD F10

design: Roberto Mantovani

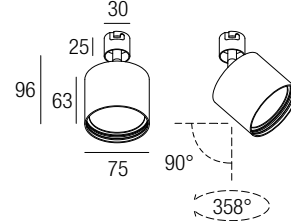

Supply current

Alimentazione
 Courant d'alimentation
 Stromversorgung
 Corriente de alimentación
500 mA (V, 18V)

Power

Potenza
 Pouissance
 Bestuekung
 Potencia
10 W

Series wiring

Cablaggio in serie
 Câblage en série
 Verkabelung in Serie
 Cableado en serie



Photometric diagrams

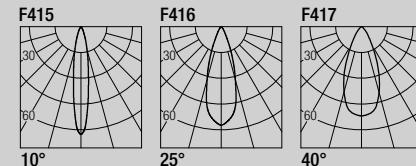

CCT/CRI/Flux

CRI85 CRI93
 2700K — 890lm 840lm
 3000K — 1000lm 930lm
 4000K — 1040lm 960lm

CRI85-93
 2-Step MacAdam



Code Construction

Costruzione del codice - Construction du code produit
 Bau der Produkt-Code - Construcción del código de producto

LADF1 X X X X

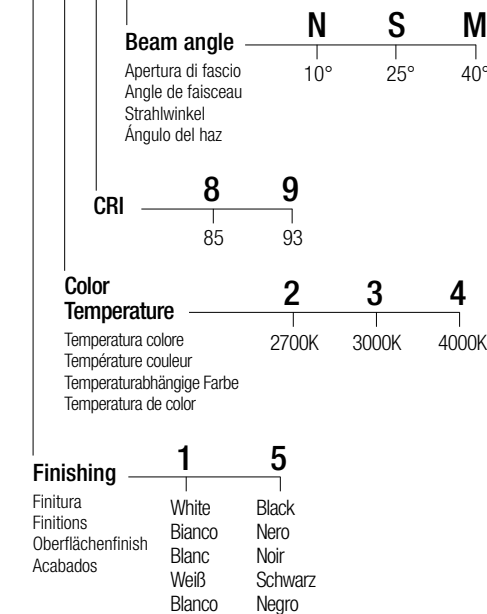

Accessories

Accessori - Accessoires
 Zubehör - Accesorios

ZQC001 ZQC001B

White Black
 Bianco Nero
 Blanc Noir
 Weiß Schwarz
 Blanco Negro

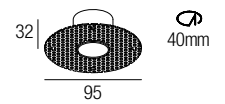

Plasterboard recessing frame
 Flangia per cartongesso
 Boîtier d'encastrement pour plaques de plâtre
 Gehäuses Trockenbau
 Cajetín para placas de yeso

LL01 LL01B

White Black
 Bianco Nero
 Blanc Noir
 Weiß Schwarz
 Blanco Negro

SL01 SL01B

White Black
 Bianco Nero
 Blanc Noir
 Weiß Schwarz
 Blanco Negro

Low luminance louver
 Filtro antiabbagliamento
 Filtre basse luminance
 Geringe Leuchtdichte-Filter
 Filtro de baja luminancia

Milky screen
 Schermo opale
 Écran opale
 Opal-Bildschirm
 Pantalla opal

AL7022

24VDC/500mA constant current converter
 Convertitore 24VDC/500mA corrente costante
 Convertisseur 24VDC/500mA courant constant
 24VDC/500mA konstanter Strom konverter
 Convertidor 24VDC/500mA corriente constante

Note: versions with extended arm length are available upon request **Nota:** versioni con lunghezza del braccetto maggiorata disponibili su richiesta **Note:** versions avec longueur du bras majorée disponibles sur demande **Anmerkung:** versionen mit erhöhter Armlänge auf Anfrage erhältlich **Nota:** Versiones con longitud del brazo aumentada disponible bajo pedido

Drivers

Alimentatori - Alimentateurs
 Netzteile - Alimentadores

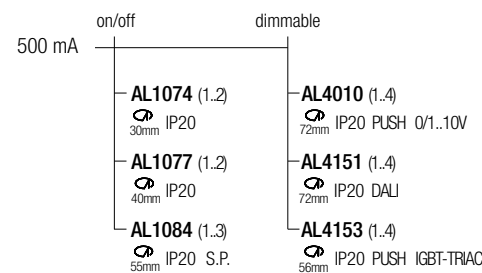

LAD F10 WALL WASHER

design: Roberto Mantovani

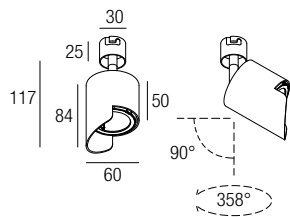

Supply current
Alimentazione
Courant d'alimentation
Stromversorgung
Corriente de alimentación
500 mA (V_i 18V)

Power
Potenza
Puissance
Bestuekung
Potencia
10 W

Series wiring
Cablaggio in serie
Câblage en série
Verkabelung in Serie
Cableado en serie



Photometric diagrams

F984

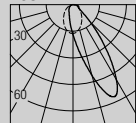

WALL WASHER

CCT/CRI/Flux

	CRI85	CRI93
2700K	890lm	840lm
3000K	1000lm	930lm
4000K	1040lm	960lm

CRI85-93
2-Step MacAdam

- DATASHEET ▶
- INSTALLATION MANUAL ▶
- CERTIFICATIONS ▶
- LDT-IES ▶
- DRAWINGS ▶



MINIJOS R2

design: Roberto Mantovani

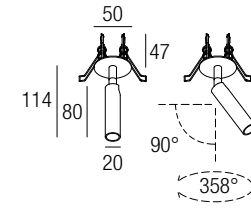

Supply current
Alimentazione
Courant d'alimentation
Stromversorgung
Corriente de alimentación
500 mA (V_i 2,9V)

Power
Potenza
Puissance
Bestuekung
Potencia
2 W

Series wiring
Cablaggio in serie
Câblage en série
Verkabelung in Serie
Cableado en serie



Photometric diagrams

F701

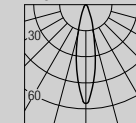

20°

F702

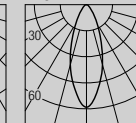

40°

CCT/CRI/Flux

	128 lm
2700K	
3000K	133 lm
4200K	154 lm

CRI85
2-Step MacAdam



Code Construction

Costruzione del codice - Construction du code produit
Bau der Produkt-Code - Construcción del código de producto

LADFW X X X

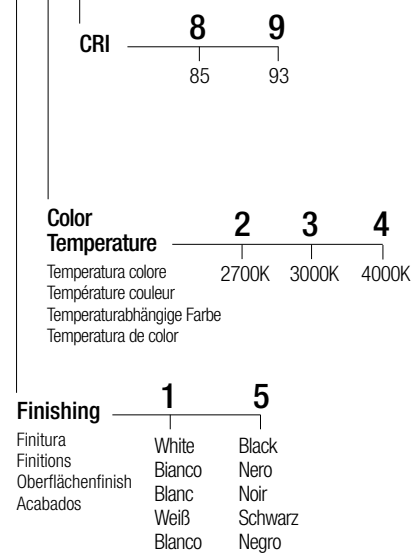

Accessories

Accessori - Accessoires
Zubehör - Accesorios

ZQC001 ZQC001B

White Black
Bianco Nero
Blanc Noir
Weiß Schwarz
Blanco Negro

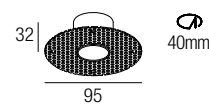

Plasterboard recessing frame
Flangia per cartongesso
Boîtier d'encastrement pour plaques de plâtre
Gehäuse Trockenbau
Cajetín para placas de yeso

AL7022

24VDC/500mA constant current converter
Convertitore 24VDC/500mA corrente costante
Convertisseur 24VDC/500mA courant constant
24VDC/500mA konstanter Strom konverter
Convertidor 24VDC/500mA corriente constante

Note: versions with extended arm length are available upon request **Nota:** versioni con lunghezza del braccetto maggiorata disponibili su richiesta **Note:** versions avec longueur du bras majorée disponibles sur demande **Anmerkung:** versionen mit erhöhter Armlänge auf Anfrage erhältlich **Nota:** Versiones con longitud del brazo aumentada disponible bajo pedido

Code Construction

Costruzione del codice - Construction du code produit
Bau der Produkt-Code - Construcción del código de producto

MJSR2 X X X

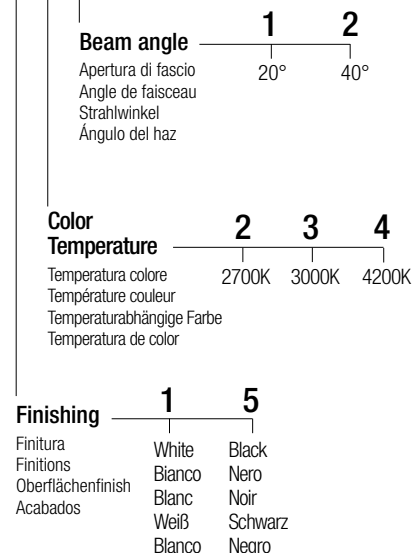

Accessories

Accessori - Accessoires
Zubehör - Accesorios

AL7022

24VDC/500mA constant current converter
Convertitore 24VDC/500mA corrente costante
Convertisseur 24VDC/500mA courant constant
24VDC/500mA konstanter Strom konverter
Convertidor 24VDC/500mA corriente constante

Note: versions with extended arm length are available upon request **Nota:** versioni con lunghezza del braccetto maggiorata disponibili su richiesta **Note:** versions avec longueur du bras majorée disponibles sur demande **Anmerkung:** versionen mit erhöhter Armlänge auf Anfrage erhältlich **Nota:** Versiones con longitud del brazo aumentada disponible bajo pedido

Drivers

Alimentatori - Alimentateurs
Netzteile - Alimentadores

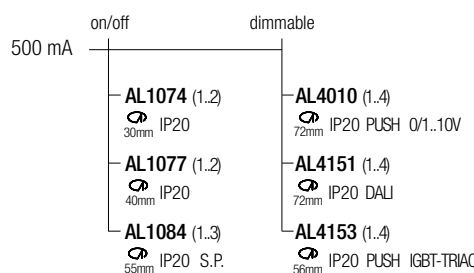

Drivers

Alimentatori - Alimentateurs
Netzteile - Alimentadores

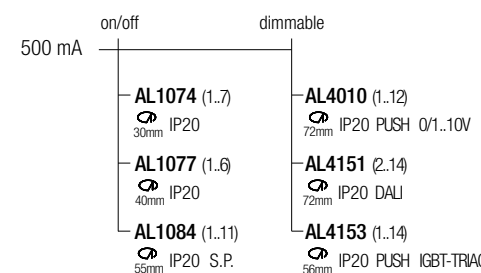

- DATASHEET ▶
- INSTALLATION MANUAL ▶
- CERTIFICATIONS ▶
- LDT-IES ▶
- DRAWINGS ▶

MINIJOS R6

design: Roberto Mantovani

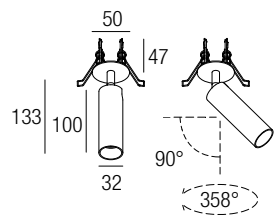
**Supply current**

Alimentazione
Courant d'alimentation
Stromversorgung
Corriente de alimentación

500 mA (V_i 9V)**Power**

Potenza
Puissance
Bestuekung
Potencia

6 W

Series wiring

Cablaggio in serie
Câblage en série
Verkabelung in Serie
Cableado en serie

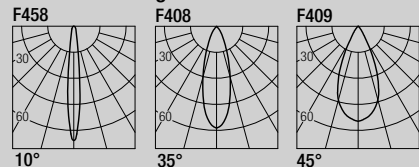
**Photometric diagrams****CCT/CRI/Flux**

2700K — 540 lm
3000K — 600 lm
4000K — 620 lm

CRI98
2-Step MacAdam

Code Construction

Costruzione del codice - Construction du code produit
Bau der Produkt-Code - Construcción del código de producto

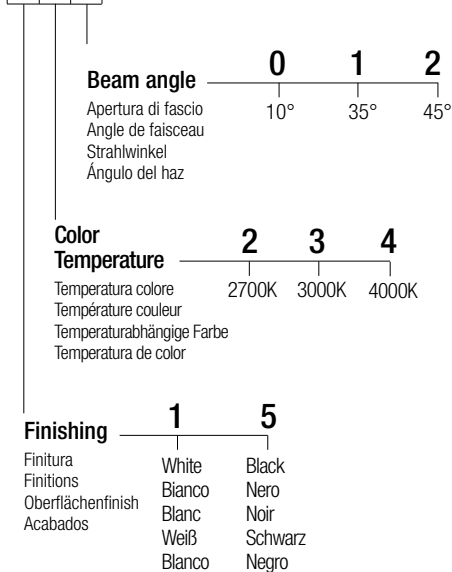
MJSR6 X X X**Drivers**

Alimentatori - Alimentateurs
Netzteile - Alimentadores

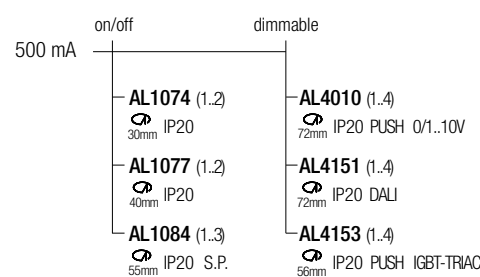

MINIJOS R10

design: Roberto Mantovani

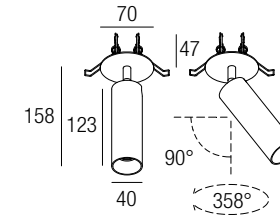
**Supply current**

Alimentazione
Courant d'alimentation
Stromversorgung
Corriente de alimentación

500 mA (V_i 18V)**Power**

Potenza
Puissance
Bestuekung
Potencia

10 W

Series wiring

Cablaggio in serie
Câblage en série
Verkabelung in Serie
Cableado en serie

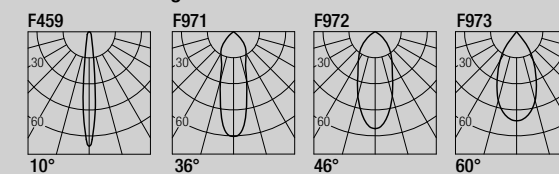
**Photometric diagrams****CCT/CRI/Flux**

CRI85 CRI93
2700K — 890lm 840lm
3000K — 1000lm 930lm
4000K — 1040lm 960lm

CRI85-93
2-Step MacAdam

Code Construction

Costruzione del codice - Construction du code produit
Bau der Produkt-Code - Construcción del código de producto

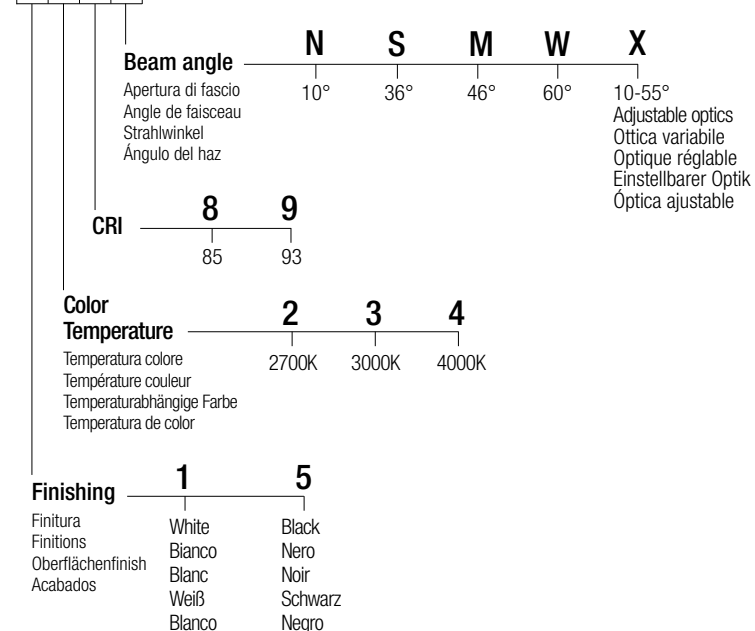
MJSR1 X X X X**Drivers**

Alimentatori - Alimentateurs
Netzteile - Alimentadores

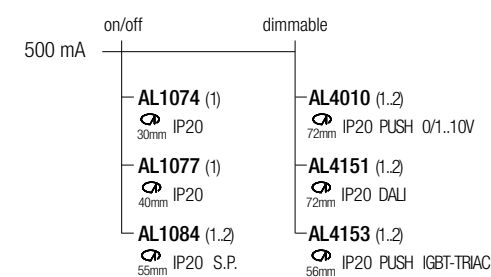
**Accessories**

Accessori - Accessoires
Zubehör - Accesorios

LJ02 White Bianco Blanc Weiß Blanco	LJ02B Black Nero Noir Schwarz Negro	SJ02 White Bianco Blanc Weiß Blanco	SJ02B Black Nero Noir Schwarz Negro
---	---	---	---

Low luminance louver
Filtro antiabbagliamento
Filtre basse luminance
Geringe Leuchtdichte-Filter
Filtro de baja luminancia

Milky screen
Schermo opale
Écran opale
Opal-Bildschirm
Pantalla opal

AL7022

24VDC/500mA constant current converter
Convertitore 24VDC/500mA corrente costante
Convertisseur 24VDC/500mA courant constant
24VDC/500mA konstanter Strom konverter
Convertidor 24VDC/500mA corriente constante

Note: versions with extended arm length are available upon request **Nota:** versioni con lunghezza del braccetto maggiorata disponibili su richiesta **Note:** versions avec longueur du bras majorée disponibles sur demande **Anmerkung:** versionen mit erhöhter Armlänge auf Anfrage erhältlich **Nota:** Versiones con longitud del brazo aumentada disponible bajo pedido

Accessories

Accessori - Accessoires
Zubehör - Accesorios

LJ01 White Bianco Blanc Weiß Blanco	LJ01B Black Nero Noir Schwarz Negro	SJ01 White Bianco Blanc Weiß Blanco	SJ01B Black Nero Noir Schwarz Negro
---	---	---	---

Low luminance louver
Filtro antiabbagliamento
Filtre basse luminance
Geringe Leuchtdichte-Filter
Filtro de baja luminancia

Milky screen
Schermo opale
Écran opale
Opal-Bildschirm
Pantalla opal

AL7022

24VDC/500mA constant current converter
Convertitore 24VDC/500mA corrente costante
Convertisseur 24VDC/500mA courant constant
24VDC/500mA konstanter Strom konverter
Convertidor 24VDC/500mA corriente constante

Note: versions with extended arm length are available upon request **Nota:** versioni con lunghezza del braccetto maggiorata disponibili su richiesta **Note:** versions avec longueur du bras majorée disponibles sur demande **Anmerkung:** versionen mit erhöhter Armlänge auf Anfrage erhältlich **Nota:** Versiones con longitud del brazo aumentada disponible bajo pedido

JOS R2

design: Roberto Mantovani

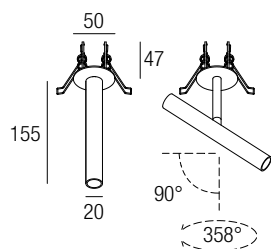
**Supply current**

Alimentazione
Courant d'alimentation
Stromversorgung
Corriente de alimentación

500 mA (V_f 2,9V)**Power**

Potenza
Puissance
Bestuekung
Potencia

2 W**Series wiring**

Cablaggio in serie
Câblage en série
Verkabelung in Serie
Cableado en serie

**CCT/CRI/Flux**

2700K — 128 lm
3000K — 133 lm
4200K — 154 lm

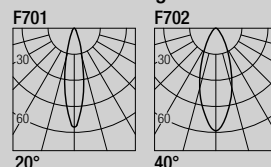
Photometric diagrams**CRI85****2-Step MacAdam****Code Construction**

Costruzione del codice - Construction du code produit
Bau der Produkt-Code - Construcción del código de producto

JSR2 X X X

Beam angle — 1 — 2
Apertura di fascio — 20° — 40°
Angle de faisceau
Strahlwinkel
Ángulo del haz

Color Temperature — 2 — 3 — 4
Temperatura colore — 2700K — 3000K — 4200K
Température couleur
Temperaturabhängige Farbe
Temperatura de color

Finishing — 1 — 5
Finitura — White — Black
Finitions — Bianco — Nero
Oberflächenfinish — Blanc — Noir
Acabados — Weiß — Schwarz
Blanco — Negro

Drivers

Alimentatori - Alimentateurs
Netzteile - Alimentadores

500 mA	on/off	dimnable
AL1074 (1..7)	30mm IP20	AL4010 (1..12)
AL1077 (1..6)	40mm IP20	AL4151 (2..14)
AL1084 (1..11)	55mm IP20 S.P.	AL4153 (1..14)
		72mm IP20 PUSH 0/1..10V
		72mm IP20 DALI 2
		56mm IP20 PUSH IGBT-TRIAC

Note: versions with extended arm length are available upon request
Nota: versioni con lunghezza del braccetto maggiorata disponibili su richiesta
Note: versions avec longueur du bras majorée disponibles sur demande
Anmerkung: versionen mit erhöhter Armlänge auf Anfrage erhältlich
Nota: Versiones con longitud del brazo aumentada disponible bajo pedido



JOS R6

design: Roberto Mantovani

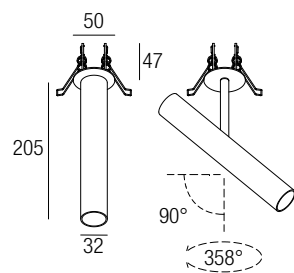
**Supply current**

Alimentazione
Courant d'alimentation
Stromversorgung
Corriente de alimentación

500 mA (V_i 9V)**Power**

Potenza
Puissance
Bestuekung
Potencia

6 W**Series wiring**

Cablaggio in serie
Câblage en série
Verkabelung in Serie
Cableado en serie

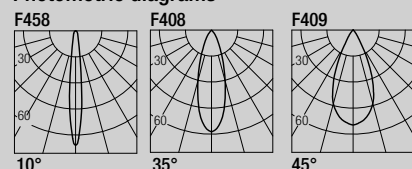
**Photometric diagrams****CCT/CRI/Flux**

2700K — 540 lm
3000K — 600 lm
4000K — 620 lm

CRI98**2-Step MacAdam****Code Construction**

Costruzione del codice - Construction du code produit
Bau der Produkt-Code - Construcción del código de producto

JSR6 X₁X₂X₃

Beam angle	0	1	2
Apertura di fascio Angle de faisceau Strahlwinkel Ángulo del haz	10°	35°	45°
Color Temperature	2	3	4
Temperatura colore Température couleur Temperaturabhängige Farbe Temperatura de color	2700K	3000K	4000K
Finishing	1	5	
Finitura Finitions Oberflächenfinish Acabados	White Bianco Blanc Weiß Blanco	Black Nero Noir Schwarz Negro	

Accessories

Accessori - Accessoires
Zubehör - Accesorios

LJ02

White
Bianco
Blanc
Weiß
Blanco

LJ02B

Black
Nero
Noir
Schwarz
Negro

Low luminance louver
Filtro antiabbagliamento
Filtre basse luminance
Geringe Leuchtdichte-Filter
Filtro de baja luminancia

**SJ02**

White
Bianco
Blanc
Weiß
Blanco

SJ02B

Black
Nero
Noir
Schwarz
Negro

Milky screen
Schermo opale
Écran opale
Opal-Bildschirm
Pantalla opal

**Drivers**

Alimentatori - Alimentateurs
Netzteile - Alimentadores

500 mA	on/off	dimmable
	AL1074 (1.2) 30mm IP20	AL4010 (1.4) 72mm IP20 PUSH 0/1..10V
	AL1077 (1.2) 40mm IP20	AL4151 (1.4) 72mm IP20 DALI 2
	AL1084 (1.3) 55mm IP20 S.P.	AL4153 (1.4) 56mm IP20 PUSH IGBT-TRIAC

Note: versions with extended arm length are available upon request
Nota: versioni con lunghezza del braccetto maggiorata disponibili su richiesta
Note: versions avec longueur du bras majorée disponibles sur demande
Anmerkung: versionen mit erhöhter Armlänge auf Anfrage erhältlich
Nota: Versiones con longitud del brazo aumentada disponible bajo pedido



JOS R10

design: Roberto Mantovani

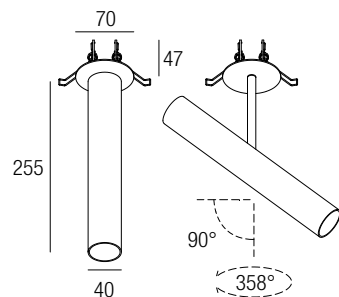

Supply current

Alimentazione
Courant d'alimentation
Stromversorgung
Corriente de alimentación

500 mA (V_i 18V)

Power

Potenza
Puissance
Bestuekung
Potencia

10 W

Series wiring

Cablaggio in serie
Câblage en série
Verkabelung in Serie
Cableado en serie



Photometric diagrams

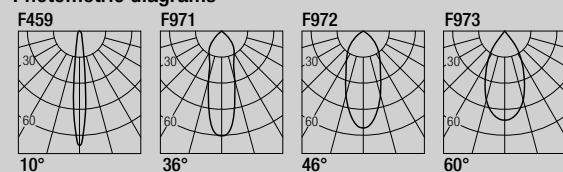

CCT/CRI/Flux

	CRI85	CRI93
2700K	890 lm	840 lm
3000K	1000 lm	930 lm
4000K	1040 lm	960 lm

CRI85 - CRI93

2-Step MacAdam

Code Construction

Costruzione del codice - Construction du code produit
Bau der Produkt-Code - Construcción del código de producto

JSR1 X X X X

	N	S	M	W	X
Beam angle	10°	36°	46°	60°	10-55°
Apertura di fascio Angle de faisceau Strahlwinkel Ángulo del haz					Adjustable optics Óptica variable Optique réglable Einstellbarer Optik Óptica ajustable
CRI	8	9			
	85	93			
Color Temperature	2	3	4		
Temperatura colore Température couleur Temperaturabhängige Farbe Temperatura de color	2700K	3000K	4000K		
Finishing	1	5			
Finitura Finitions Oberflächenfinish Acabados	White Bianco Blanc Weiß Blanco	Black Nero Noir Schwarz Negro			

Note: versions with extended arm length are available upon request
Nota: versioni con lunghezza del braccetto maggiorata disponibili su richiesta
Note: versions avec longueur du bras majorée disponibles sur demande
Anmerkung: versionen mit erhöhter Armlänge auf Anfrage erhältlich
Nota: Versiones con longitud del brazo aumentada disponible bajo pedido

Accessories

Accessori - Accessoires
Zubehör - Accesorios

LJ01	LJ01B	SJ01	SJ01B
White Bianco Blanc Weiß Blanco	Black Nero Noir Schwarz Negro	White Bianco Blanc Weiß Blanco	Black Nero Noir Schwarz Negro

Low luminance louver
Filtro antiabbagliamento
Filtre basse luminance
Geringe Leuchtdichte-Filter
Filtro de baja luminancia



Milky screen
Schermo opale
Écran opale
Opal-Bildschirm
Pantalla opal



Note: the filter and the screen are not available in adjustable optics version 10-55° - **Nota:** il filtro e lo schermo non sono disponibili nella versione ad ottica regolabile 10-55° - **Note:** le filtre et l'écran ne sont pas disponibles dans la version à optique réglable 10-55° - **Anmerkung:** Filter und Bildschirm sind in der einstellbaren optischen Version 10-55° nicht verfügbar - **Nota:** el filtro y la pantalla no están disponibles en la versión de óptica ajustable 10-55°

Drivers

Alimentatori - Alimentateurs
Netzteile - Alimentadores

500 mA	on/off	dimmable
AL1074 (1)	30mm	IP20
AL1077 (1)	40mm	IP20
AL1084 (1.2)	55mm	IP20 S.P.
AL4010 (1.2)	72mm	IP20 PUSH 0/1..10V
AL4151 (1.2)	72mm	IP20 DALI 2
AL4153 (1.2)	56mm	IP20 PUSH IGBT-TRIAC



LAD R6

design: Roberto Mantovani

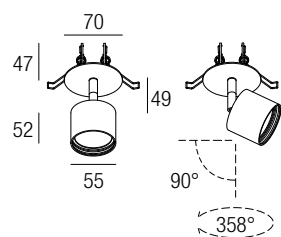

Supply current

Alimentazione
Courant d'alimentation
Stromversorgung
Corriente de alimentación

500 mA (V, 9V)

Power

Potenza
Puissance
Bestuekung
Potencia

6 W

Series wiring

Cablaggio in serie
Câblage en série
Verkabelung in Serie
Cableado en serie



CCT/CRI/Flux

2700K — 540 lm
3000K — 600 lm
4000K — 620 lm

Photometric diagrams

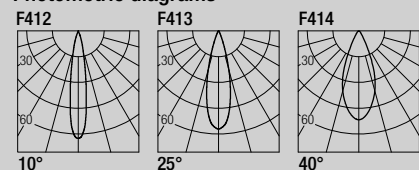

CRI98

2-Step MacAdam

Code Construction

Costruzione del codice - Construction du code produit
Bau der Produkt-Code - Construcción del código de producto

LADR6 X X X

Beam angle Apertura di fascio Angle de faisceau Strahlwinkel Angulo del haz	1	2	3
	10°	25°	40°
Color Temperature Temperatura colore Température couleur Temperaturabhängige Farbe Temperatura de color	2	3	4
	2700K	3000K	4000K
Finishing Finitura Finitions Oberflächenfinish Acabados	1	5	
	White Bianco Blanc Weiß Blanco	Black Nero Noir Schwarz Negro	

Accessories

Accessori - Accessoires
Zubehör - Accesorios

LL02

White
Bianco
Blanc
Weiß
Blanco

LL02B

Black
Nero
Noir
Schwarz
Negro

SL02

White
Bianco
Blanc
Weiß
Blanco

SL02B

Black
Nero
Noir
Schwarz
Negro

Low luminance louver
Filtro antiabbagliamento
Filtre basse luminance
Geringe Leuchtdichte-Filter
Filtro de baja luminancia



Milky screen
Schermo opale
Écran opale
Opal-Bildschirm
Pantalla opal



Drivers

Alimentatori - Alimentateurs
Netzteile - Alimentadores

500 mA	on/off	dimmable
	AL1074 (1.2)	AL4010 (1.4)
	30mm IP20	72mm IP20 PUSH 0/1..10V
	AL1077 (1.2)	AL4151 (1.4)
	40mm IP20	72mm IP20 DALI 2
	AL1084 (1.3)	AL4153 (1.4)
	55mm IP20 S.P.	56mm IP20 PUSH IGBT-TRIAC

Note: versions with extended arm length are available upon request
Nota: versioni con lunghezza del braccetto maggiorata disponibili su richiesta
Note: versions avec longueur du bras majorée disponibles sur demande
Anmerkung: versionen mit erhöhter Armlänge auf Anfrage erhältlich
Nota: Versiones con longitud del brazo aumentada disponible bajo pedido



LAD R10

design: Roberto Mantovani

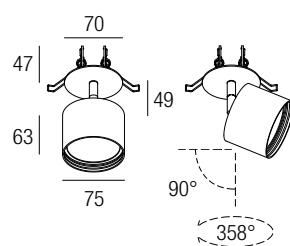
**Supply current**

Alimentazione
Courant d'alimentation
Stromversorgung
Corriente de alimentación

500 mA (V_i 18V)**Power**

Potenza
Puissance
Bestuekung
Potencia

10 W

Series wiring

Cablaggio in serie
Câblage en série
Verkabelung in Serie
Cableado en serie

**CCT/CRI/Flux**

	CRI85	CRI93
2700K	890 lm	840 lm
3000K	1000 lm	930 lm
4000K	1040 lm	960 lm

CRI85 - CRI93
2-Step MacAdam

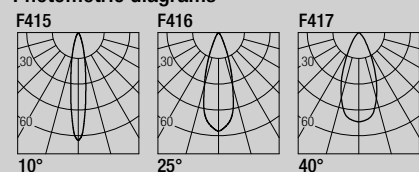
Photometric diagrams**Code Construction**

Costruzione del codice - Construction du code produit
Bau der Produkt-Code - Construcción del código de producto

LADR1 X.X.X.X

Beam angle N S M
Apertura di fascio 10° 25° 40°
Angle de faisceau
Strahlwinkel
Ángulo del haz

CRI 8 9
85 93

Color Temperature 2 3 4
Temperatura colore 2700K 3000K 4000K
Température couleur
Temperaturabhängige Farbe
Temperatura de color

Finishing 1 5
Finitura White Black
Finitions Bianco Nero
Oberflächenfinish Blanc Noir
Acabados Weiß Schwarz
Blanco Negro

Accessories

Accessori - Accessoires
Zubehör - Accesorios

LL01

White
Bianco
Blanc
Weiß
Blanco

LL01B

Black
Nero
Noir
Schwarz
Negro

SL01

White
Bianco
Blanc
Weiß
Blanco

SL01B

Black
Nero
Noir
Schwarz
Negro

Low luminance louver
Filtro antiabbagliamento
Filtre basse luminance
Geringe Leuchtdichte-Filter
Filtro de baja luminancia



Milky screen
Schermo opale
Écran opale
Opal-Bildschirm
Pantalla opal

**Drivers**

Alimentatori - Alimentateurs
Netzteile - Alimentadores

500 mA	on/off	dimmable
AL1074 (1)	30mm IP20	AL4010 (1.2) 72mm IP20 PUSH 0/1..10V
AL1077 (1)	40mm IP20	AL4151 (1.2) 72mm IP20 DALI 2
AL1084 (1.2)	55mm IP20 S.P.	AL4153 (1.2) 56mm IP20 PUSH IGBT-TRIAC
AL9051 (1)	44mm IP67	AL8050 (1.2) IP67 DALI

Note: versions with extended arm length are available upon request
Nota: versioni con lunghezza del braccetto maggiorata disponibili su richiesta
Note: versions avec longueur du bras majorée disponibles sur demande
Anmerkung: versionen mit erhöhter Armlänge auf Anfrage erhältlich
Nota: Versiones con longitud del brazo aumentada disponible bajo pedido



LAD R10 WALL WASHER

design: Roberto Mantovani

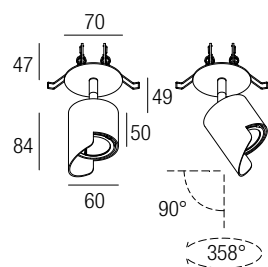
**Supply current**

Alimentazione
Courant d'alimentation
Stromversorgung
Corriente de alimentación
500 mA (V_i 18V)

Power

Potenza
Puissance
Bestuekung
Potencia
10 W

Series wiring

Cablaggio in serie
Câblage en série
Verkabelung in Serie
Cableado en serie

**Photometric diagrams**

F984

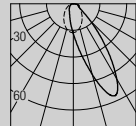

WALL WASHER

CCT/CRI/Flux

	CRI85	CRI93
2700K	890 lm	840 lm
3000K	1000 lm	930 lm
4000K	1040 lm	960 lm

CRI85 - CRI93**2-Step MacAdam****Code Construction**

Costruzione del codice - Construction du code produit
Bau der Produkt-Code - Construcción del código de producto

LADRW X X X

CRI	8	9	
	85	93	
Color Temperature	2	3	4
Temperatura colore Température couleur Temperaturabhängige Farbe Temperatura de color	2700K	3000K	4000K
Finishing	1	5	
Finitura Finitions Oberflächenfinish Acabados	White Bianco Blanc Weiß Blanco	Black Nero Noir Schwarz Negro	

Drivers

Alimentatori - Alimentateurs
Netzteile - Alimentadores

500 mA	on/off	dimmable
AL1074 (1)	30mm IP20	AL4010 (1.2) 72mm IP20 PUSH 0/1..10V
AL1077 (1)	40mm IP20	AL4151 (1.2) 72mm IP20 DALI2
AL1084 (1.2)	55mm IP20 S.P.	AL4153 (1.2) 56mm IP20 PUSH IGBT-TRIAC

Note: versions with extended arm length are available upon request
Nota: versioni con lunghezza del braccetto maggiorata disponibili su richiesta
Note: versions avec longueur du bras majorée disponibles sur demande
Anmerkung: versionen mit erhöhter Armlänge auf Anfrage erhältlich
Nota: Versiones con longitud del brazo aumentada disponible bajo pedido



MINIJOS S2

design: Roberto Mantovani

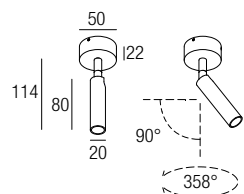

Supply current

Alimentazione
Courant d'alimentation
Stromversorgung
Corriente de alimentación

24 VDC

Power

Potenza
Puissance
Bestuekung
Potencia

2 W

Series wiring

Cablaggio in serie
Câblage en série
Verkabelung in Serie
Cableado en serie



CCT/CRI/Flux

Photometric diagrams

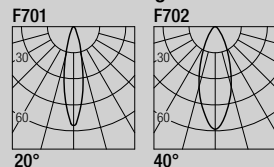

2700K — 128 lm
3000K — 133 lm
4200K — 154 lm

CRI85

2-Step MacAdam



Code Construction

Costruzione del codice - Construction du code produit
Bau der Produkt-Code - Construcción del código de producto

MJSS2 X X X

Beam angle — 1 — 2
Apertura di fascio — 20° — 40°
Angle de faisceau
Strahlwinkel
Ángulo del haz

Color Temperature — 2 — 3 — 4
Temperatura colore — 2700K — 3000K — 4200K
Température couleur
Temperaturabhängige Farbe
Temperatura de color

Finishing — 1 — 5
Finitura — White — Black
Finitions — Bianco — Nero
Oberflächenfinish — Blanc — Noir
Acabados — Weiß — Schwarz
Blanco — Negro

Drivers

Alimentatori - Alimentateurs
Netzteile - Alimentadores

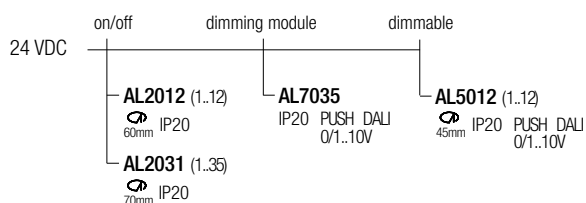

Note: dimming module AL7035 to be used in combination with an on/off 24VDC power supply **Nota:** modulo di dimmerazione AL7035 da utilizzare in combinazione con un alimentatore on/off 24VDC **Note:** module de variation AL7035 d'intensité à utiliser en combinaison avec une alimentation on/off 24VDC **Anmerkung:** Dimmmodul AL7035 zur Verwendung in Kombination mit einem on/off 24VDC-Netzteil **Nota:** módulo de regulación AL7035 se utiliza en combinación con una fuente de alimentación on/off 24VDC

MINIJOS S6

design: Roberto Mantovani

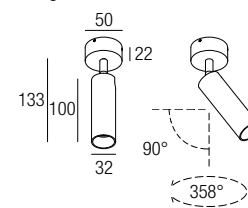

Supply current

Alimentazione
Courant d'alimentation
Stromversorgung
Corriente de alimentación

24 VDC

Power

Potenza
Puissance
Bestuekung
Potencia

6 W

Series wiring

Cablaggio in serie
Câblage en série
Verkabelung in Serie
Cableado en serie



CCT/CRI/Flux

Photometric diagrams

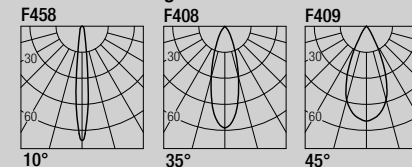

2700K — 540 lm
3000K — 600 lm
4000K — 620 lm

CRI98

2-Step MacAdam



Code Construction

Costruzione del codice - Construction du code produit
Bau der Produkt-Code - Construcción del código de producto

MJSS6 X X X

Beam angle — 0 — 1 — 2
Apertura di fascio — 10° — 35° — 45°
Angle de faisceau
Strahlwinkel
Ángulo del haz

Color Temperature — 2 — 3 — 4
Temperatura colore — 2700K — 3000K — 4000K
Température couleur
Temperaturabhängige Farbe
Temperatura de color

Finishing — 1 — 5
Finitura — White — Black
Finitions — Bianco — Nero
Oberflächenfinish — Blanc — Noir
Acabados — Weiß — Schwarz
Blanco — Negro

Drivers

Alimentatori - Alimentateurs
Netzteile - Alimentadores

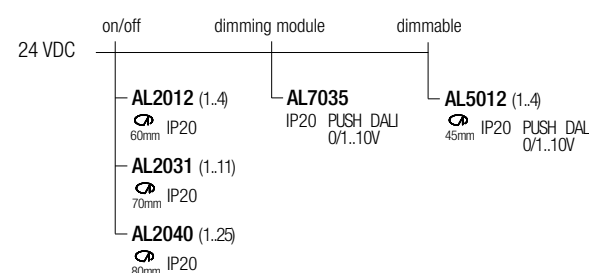

Note: dimming module AL7035 to be used in combination with an on/off 24VDC power supply **Nota:** modulo di dimmerazione AL7035 da utilizzare in combinazione con un alimentatore on/off 24VDC **Note:** module de variation AL7035 d'intensité à utiliser en combinaison avec une alimentation on/off 24VDC **Anmerkung:** Dimmmodul AL7035 zur Verwendung in Kombination mit einem on/off 24VDC-Netzteil **Nota:** módulo de regulación AL7035 se utiliza en combinación con una fuente de alimentación on/off 24VDC

Accessories

Accessori - Accessoires
Zubehör - Accesorios

LJ02	LJ02B	SJ02	SJ02B
White	Black	White	Black
Bianco	Nero	Bianco	Nero
Blanc	Noir	Blanc	Noir
Weiß	Schwarz	Weiß	Schwarz
Blanco	Negro	Blanco	Negro

Low luminance louver
Filtro antiabbagliamento
Filtre basse luminance
Geringe Leuchtdichte-Filter
Filtro de baja luminancia



Milky screen
Schermo opale
Écran opale
Opal-Bildschirm
Pantalla opal



Note: versions with extended arm length are available upon request **Nota:** versioni con lunghezza del braccetto maggiorata disponibili su richiesta **Note:** versions avec longueur du bras majorée disponibles sur demande **Anmerkung:** versionen mit erhöhter Armlänge auf Anfrage erhältlich **Nota:** Versiones con longitud del brazo aumentada disponible bajo pedido

MINIJOS S10

design: Roberto Mantovani

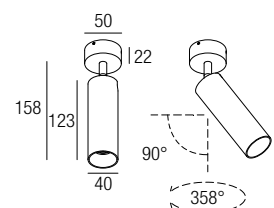

Supply current

Alimentazione
Courant d'alimentation
Stromversorgung
Corriente de alimentación

24 VDC

Power

Potenza
Puissance
Bestuekung
Potencia

10 W

Series wiring

Cablaggio in serie
Câblage en série
Verkabelung in Serie
Cableado en serie



Photometric diagrams

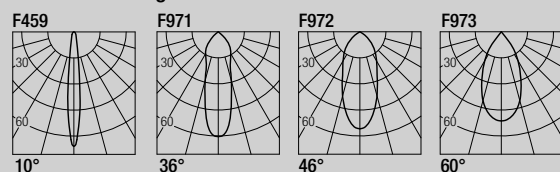

CCT/CRI/Flux

CCT	CRI85	CRI93
2700K	890lm	840lm
3000K	1000lm	930lm
4000K	1040lm	960lm

CRI85-93

2-Step MacAdam



JOS S2

design: Roberto Mantovani

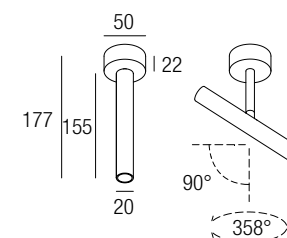

Supply current

Alimentazione
Courant d'alimentation
Stromversorgung
Corriente de alimentación

24 VDC

Power

Potenza
Puissance
Bestuekung
Potencia

2 W

Parallel wiring

Cablaggio in parallelo
Câblage en parallèle
Verkabelung in parallel
Cableado en paralelo



Photometric diagrams

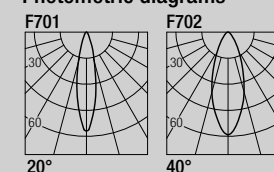

CCT/CRI/Flux

2700K	128 lm
3000K	133 lm
4200K	154 lm

CRI85

2-Step MacAdam



Code Construction

Costruzione del codice - Construction du code produit
Bau der Produkt-Code - Construcción del código de producto

MJSS1 X X X X

Beam angle
Apertura di fascio
Angle de faisceau
Strahlwinkel
Ángulo del haz

N 10° S 36° M 46° W 60° X 10-55°
Adjustable optics
Optica variabile
Optique réglable
Einstellbarer Optik
Óptica ajustable

CRI 8 9
85 93

Color Temperature 2 3 4
Temperatura colore
Température couleur
Temperaturabhängige Farbe
Temperatura de color

2700K 3000K 4000K

Finishing 1 5
Finitura
Finitions
Oberflächenfinish
Acabados

1 White Bianco Weiß Blanco
5 Black Nero Noir Schwarz Negro

Accessories

Accessori - Accessoires
Zubehör - Accesorios

LJ01 White Bianco Weiß Blanco
LJ01B Black Nero Noir Schwarz Negro

SJ01 White Bianco Weiß Blanco
SJ01B Black Nero Noir Schwarz Negro

Low luminance louver
Filtro antiabbagliamento
Filtre basse luminance
Geringe Leuchtdichte-Filter
Filtro de baja luminancia



Milky screen
Schermo opale
Écran opale
Opal-Bildschirm
Pantalla opal



Note: versions with extended arm length are available upon request
Nota: versioni con lunghezza del braccetto maggiorata disponibili su richiesta
Note: versions avec longueur du bras majorée disponibles sur demande
Anmerkung: versionen mit erhöhter Armlänge auf Anfrage erhältlich
Nota: Versiones con longitud del brazo aumentada disponible bajo pedido

Code Construction

Costruzione del codice - Construction du code produit
Bau der Produkt-Code - Construcción del código de producto

JSS2 X X X

Beam angle 1 2
Apertura di fascio
Angle de faisceau
Strahlwinkel
Ángulo del haz

20° 40°

Color Temperature 2 3 4
Temperatura colore
Température couleur
Temperaturabhängige Farbe
Temperatura de color

2700K 3000K 4200K

Finishing 1 5
Finitura
Finitions
Oberflächenfinish
Acabados

1 White Bianco Weiß Blanco
5 Black Nero Noir Schwarz Negro

Note: versions with extended arm length are available upon request
Nota: versioni con lunghezza del braccetto maggiorata disponibili su richiesta
Note: versions avec longueur du bras majorée disponibles sur demande
Anmerkung: versionen mit erhöhter Armlänge auf Anfrage erhältlich
Nota: Versiones con longitud del brazo aumentada disponible bajo pedido

Drivers

Alimentatori - Alimentateurs
Netzteile - Alimentadores



Note: dimming module AL7035 to be used in combination with an on/off 24VDC power supply
Nota: modulo di dimmerazione AL7035 da utilizzare in combinazione con un alimentatore on/off 24VDC
Note: module de variation AL7035 d'intensité à utiliser en combinaison avec une alimentation on/off 24VDC
Anmerkung: Dimmmodul AL7035 zur Verwendung in Kombination mit einem on/off 24VDC-Netzteil
Nota: módulo de regulación AL7035 se utiliza en combinación con una fuente de alimentación on/off 24VDC

Drivers

Alimentatori - Alimentateurs
Netzteile - Alimentadores

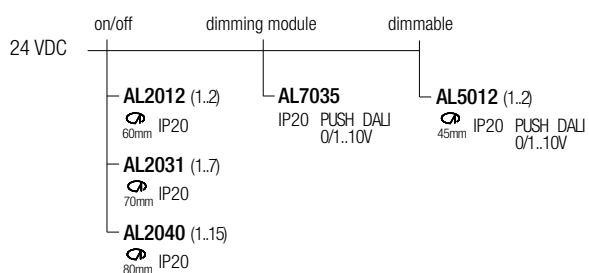

Note: dimming module AL7035 to be used in combination with an on/off 24VDC power supply
Nota: modulo di dimmerazione AL7035 da utilizzare in combinazione con un alimentatore on/off 24VDC
Note: module de variation AL7035 d'intensité à utiliser en combinaison avec une alimentation on/off 24VDC
Anmerkung: Dimmmodul AL7035 zur Verwendung in Kombination mit einem on/off 24VDC-Netzteil
Nota: módulo de regulación AL7035 se utiliza en combinación con una fuente de alimentación on/off 24VDC

JOS S6

design: Roberto Mantovani

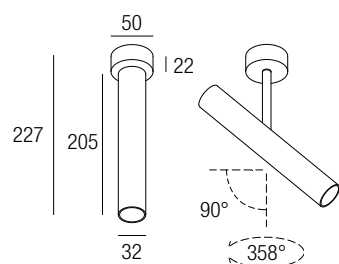

Supply current

Alimentazione
Courant d'alimentation
Stromversorgung
Corriente de alimentación

24 VDC

Power

Potenza
Puissance
Bestuekung
Potencia

6 W

Parallel wiring

Cablaggio in parallelo
Câblage en parallèle
Verkabelung in parallel
Cableado en paralelo



Photometric diagrams

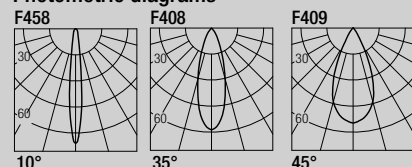

CCT/CRI/Flux

2700K — 540 lm
3000K — 600 lm
4000K — 620 lm

CRI98

2-Step MacAdam



Code Construction

Costruzione del codice - Construction du code produit
Bau der Produkt-Code - Construcción del código de producto

JSS6 X X X

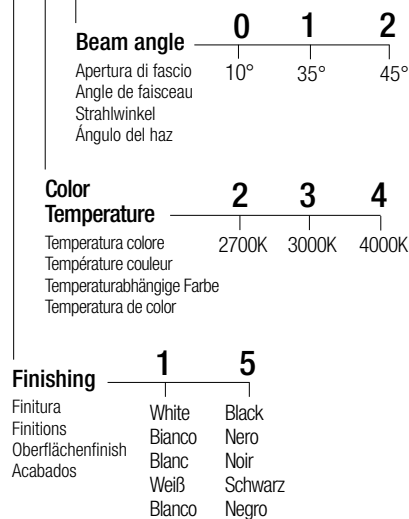

Accessories

Accessori - Accessoires
Zubehör - Accesorios

LJ02	LJ02B	SJ02	SJ02B
White	Black	White	Black
Bianco	Nero	Bianco	Nero
Blanc	Noir	Blanc	Noir
Weiß	Schwarz	Weiß	Schwarz
Blanco	Negro	Blanco	Negro

Low luminance louver
Filtro antiabbagliamento
Filtre basse luminance
Geringe Leuchtdichte-Filter
Filtro de baja luminancia



Milky screen
Schermo opale
Écran opale
Opal-Bildschirm
Pantalla opal



Drivers

Alimentatori - Alimentateurs
Netzteile - Alimentadores

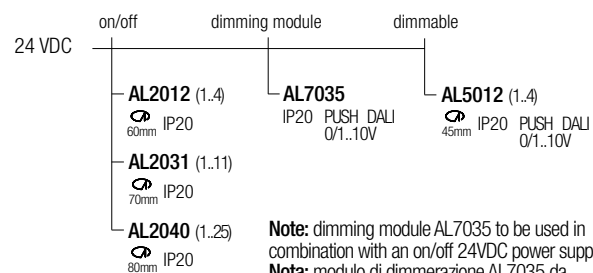

Note: dimming module AL7035 to be used in combination with an on/off 24VDC power supply
Nota: modulo di dimmerazione AL7035 da utilizzare in combinazione con un alimentatore on/off 24VDC
Note: module de variation AL7035 d'intensité à utiliser en combinaison avec une alimentation on/off 24VDC
Anmerkung: Dimmmodul AL7035 zur Verwendung in Kombination mit einem on/off 24VDC-Netzteil
Nota: módulo de regulación AL7035 se utiliza en combinación con una fuente de alimentación on/off 24VDC

Note: versions with extended arm length are available upon request
Nota: versioni con lunghezza del braccetto maggiorata disponibili su richiesta
Note: versions avec longueur du bras majorée disponibles sur demande
Anmerkung: versionen mit erhöhter Armlänge auf Anfrage erhältlich
Nota: Versiones con longitud del brazo aumentada disponible bajo pedido



JOS S10

design: Roberto Mantovani

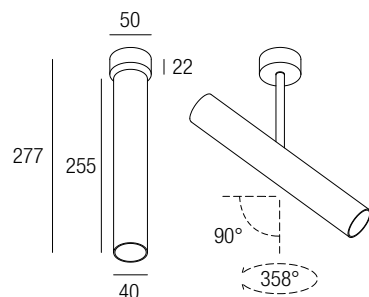

Supply current

Alimentazione
Courant d'alimentation
Stromversorgung
Corriente de alimentación
24 VDC

Power

Potenza
Puissance
Bestuekung
Potencia
10 W

Parallel wiring

Cablaggio in parallelo
Câblage en parallèle
Verkabelung in parallel
Cableado en paralelo



Photometric diagrams

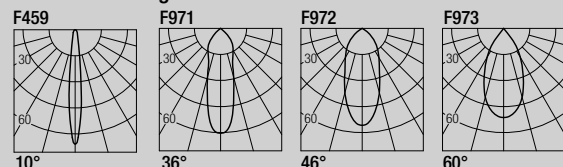

CCT/CRI/Flux

	CRI85	CRI93
2700K	890 lm	840 lm
3000K	1000 lm	930 lm
4000K	1040 lm	960 lm

CRI85 - CRI93

2-Step MacAdam



Code Construction

Costruzione del codice - Construction du code produit
Bau der Produkt-Code - Construcción del código de producto

JSS1 X X X X

Beam angle	N	S	M	W	X
Apertura di fascio Angle de faisceau Strahlwinkel Ángulo del haz	10°	36°	46°	60°	10-55°

Adjustable optics
Optica variabile
Optique réglable
Einstellbarer Optik
Óptica ajustable

CRI	8	9
	85	93

Color Temperature	2	3	4
Temperatura colore Température couleur Temperaturabhängige Farbe Temperatura de color	2700K	3000K	4000K

Finishing	1	5
Finitura Finitions Oberflächenfinish Acabados	White Bianco Blanc Weiß Blanco	Black Nero Noir Schwarz Negro

Accessories

Accessori - Accessoires
Zubehör - Accesorios

LJ01	LJ01B	SJ01	SJ01B
White Bianco Blanc Weiß Blanco	Black Nero Noir Schwarz Negro	White Bianco Blanc Weiß Blanco	Black Nero Noir Schwarz Negro

Low luminance louver
Filtro antiabbagliamento
Filtre basse luminance
Geringe Leuchtdichte-Filter
Filtro de baja luminancia



Milky screen
Schermo opale
Écran opale
Opal-Bildschirm
Pantalla opal



Note: the filter and the screen are not available in adjustable optics version 10-55° - **Nota:** il filtro e lo schermo non sono disponibili nella versione ad ottica regolabile 10-55° - **Note:** le filtre et l'écran ne sont pas disponibles dans la version à optique réglable 10-55° - **Anmerkung:** Filter und Bildschirm sind in der einstellbaren optischen Version 10-55° nicht verfügbar - **Nota:** el filtro y la pantalla no están disponibles en la versión de óptica ajustable 10-55°

Drivers

Alimentatori - Alimentateurs
Netzteile - Alimentadores

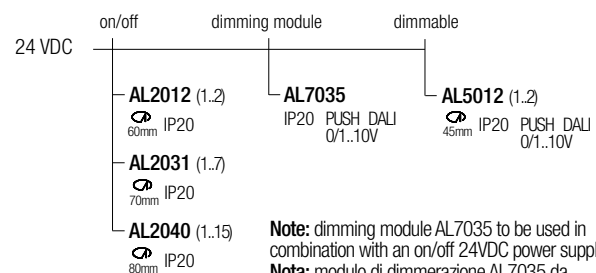

Note: dimming module AL7035 to be used in combination with an on/off 24VDC power supply
Nota: modulo di dimmerazione AL7035 da utilizzare in combinazione con un alimentatore on/off 24VDC
Note: module de variation AL7035 d'intensité à utiliser en combinaison avec une alimentation on/off 24VDC
Anmerkung: Dimmmodul AL7035 zur Verwendung in Kombination mit einem on/off 24VDC-Netzteil
Nota: módulo de regulación AL7035 se utiliza en combinación con una fuente de alimentación on/off 24VDC

Note: versions with extended arm length are available upon request
Nota: versioni con lunghezza del braccetto maggiorata disponibili su richiesta
Note: versions avec longueur du bras majorée disponibles sur demande
Anmerkung: versionen mit erhöhter Armlänge auf Anfrage erhältlich
Nota: Versiones con longitud del brazo aumentada disponible bajo pedido



LAD S6

design: Roberto Mantovani

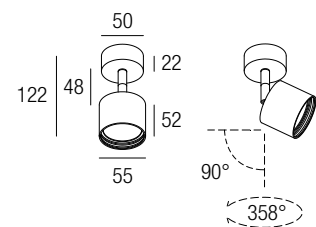

Supply current

Alimentazione
Courant d'alimentation
Stromversorgung
Corriente de alimentación

24 VDC

Power

Potenza
Puissance
Bestuekung
Potencia

6 W

Parallel wiring

Cablaggio in parallelo
Câblage en parallèle
Verkabelung in parallel
Cableado en paralelo



CCT/CRI/Flux

2700K — 540 lm
3000K — 600 lm
4000K — 620 lm

Photometric diagrams

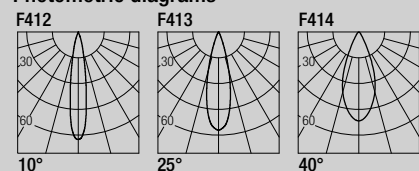

CRI98

2-Step MacAdam



Code Construction

Costruzione del codice - Construction du code produit
Bau der Produkt-Code - Construcción del código de producto

LADS6 X X X

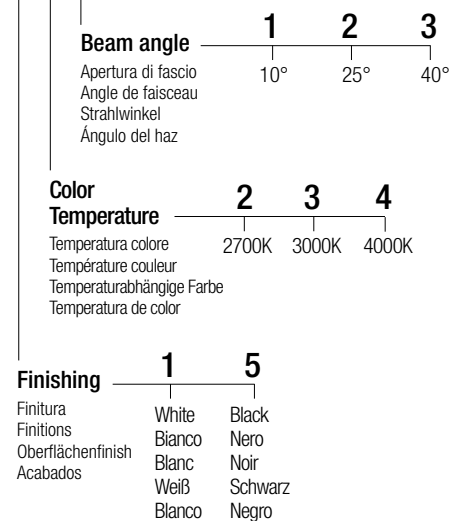

Accessories

Accessori - Accessoires
Zubehör - Accesorios

LL02 White Bianco Blanc Weiß Blanco	LL02B Black Nero Noir Schwarz Negro	SL02 White Bianco Blanc Weiß Blanco	SL02B Black Nero Noir Schwarz Negro
Low luminance louver Filtro antiabbagliamento Filtre basse luminance Geringe Leuchtdichte-Filter Filtro de baja luminancia		Milky screen Schermo opale Écran opale Opal-Bildschirm Pantalla opal	

Drivers

Alimentatori - Alimentateurs
Netzteile - Alimentadores

24 VDC	on/off	dimming module	dimmable
	AL2012 (1.4) 60mm IP20	AL7035 IP20 PUSH DALI 0/1..10V	AL5012 (1.4) 45mm IP20 PUSH DALI 0/1..10V
	AL2031 (1.11) 70mm IP20		
	AL2040 (1.25) 80mm IP20		

Note: dimming module AL7035 to be used in combination with an on/off 24VDC power supply
Nota: modulo di dimmerazione AL7035 da utilizzare in combinazione con un alimentatore on/off 24VDC
Note: module de variation AL7035 d'intensité à utiliser en combinaison avec une alimentation on/off 24VDC
Anmerkung: Dimmmodul AL7035 zur Verwendung in Kombination mit einem on/off 24VDC-Netzteil
Nota: módulo de regulación AL7035 se utiliza en combinación con una fuente de alimentación on/off 24VDC

Note: versions with extended arm length are available upon request
Nota: versioni con lunghezza del braccetto maggiorata disponibili su richiesta
Note: versions avec longueur du bras majorée disponibles sur demande
Anmerkung: versionen mit erhöhter Armlänge auf Anfrage erhältlich
Nota: Versiones con longitud del brazo aumentada disponible bajo pedido



LAD S10

design: Roberto Mantovani

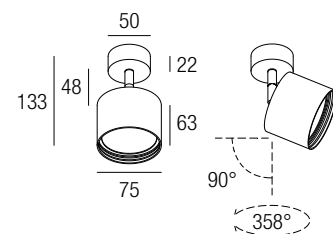

Supply current

Alimentazione
Courant d'alimentation
Stromversorgung
Corriente de alimentación
24 VDC

Power

Potenza
Puissance
Bestuekung
Potencia
10 W

Parallel wiring

Cablaggio in parallelo
Câblage en parallèle
Verkabelung in parallel
Cableado en paralelo



CCT/CRI/Flux

	CRI85	CRI93
2700K	890 lm	840 lm
3000K	1000 lm	930 lm
4000K	1040 lm	960 lm

CRI85 - CRI93
2-Step MacAdam

Photometric diagrams

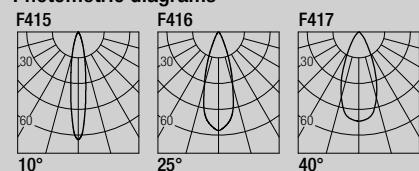

Code Construction

Costruzione del codice - Construction du code produit
Bau der Produkt-Code - Construcción del código de producto

LADS1 X.X.X.X

Beam angle **N S M**
Apertura di fascio 10° 25° 40°
Angle de faisceau
Strahlwinkel
Ángulo del haz

CRI **8 9**
85 93

Color Temperature **2 3 4**
Temperatura colore 2700K 3000K 4000K
Température couleur
Temperaturabhängige Farbe
Temperatura de color

Finishing **1 5**
Finitura White Black
Finitions Bianco Nero
Oberflächenfinish Blanc Noir
Acabados Weiß Schwarz
Blanco Negro

Accessories

Accessori - Accessoires
Zubehör - Accesorios

LL01

White
Bianco
Blanc
Weiß
Blanco

LL01B

Black
Nero
Noir
Schwarz
Negro

SL01

White
Bianco
Blanc
Weiß
Blanco

SL01B

Black
Nero
Noir
Schwarz
Negro

Low luminance louver
Filtro antiabbagliamento
Filtre basse luminance
Geringe Leuchtdichte-Filter
Filtro de baja luminancia



Milky screen
Schermo opale
Écran opale
Opal-Bildschirm
Pantalla opal



Drivers

Alimentatori - Alimentateurs
Netzteile - Alimentadores

24 VDC	on/off	dimming module	dimmable
	AL2012 (1.2) 60mm IP20	AL7035 IP20 PUSH DALI 0/1..10V	AL5012 (1.2) 45mm IP20 PUSH DALI 0/1..10V
	AL2031 (1.7) 70mm IP20		
	AL2040 (1.15) 80mm IP20		

Note: dimming module AL7035 to be used in combination with an on/off 24VDC power supply
Nota: modulo di dimmerazione AL7035 da utilizzare in combinazione con un alimentatore on/off 24VDC
Note: module de variation AL7035 d'intensité à utiliser en combinaison avec une alimentation on/off 24VDC
Anmerkung: Dimmmodul AL7035 zur Verwendung in Kombination mit einem on/off 24VDC-Netzteil
Nota: módulo de regulación AL7035 se utiliza en combinación con una fuente de alimentación on/off 24VDC

Note: versions with extended arm length are available upon request
Nota: versioni con lunghezza del braccetto maggiorata disponibili su richiesta
Note: versions avec longueur du bras majorée disponibles sur demande
Anmerkung: versionen mit erhöhter Armlänge auf Anfrage erhältlich
Nota: Versiones con longitud del brazo aumentada disponible bajo pedido



LAD S10 WALL WASHER

design: Roberto Mantovani

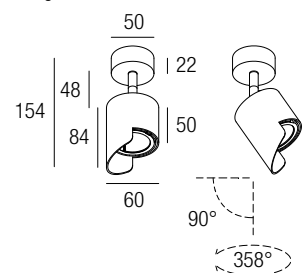

Supply current

Alimentazione
Courant d'alimentation
Stromversorgung
Corriente de alimentación

24 VDC

Power

Potenza
Puissance
Bestuekung
Potencia

10 W

Parallel wiring

Cablaggio in parallelo
Câblage en parallèle
Verkabelung in parallel
Cableado en paralelo



Photometric diagrams

F984

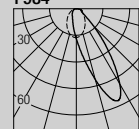

WALL WASHER

CCT/CRI/Flux

	CRI85	CRI93
2700K	890 lm	840 lm
3000K	1000 lm	930 lm
4000K	1040 lm	960 lm

CRI85 - CRI93
2-Step MacAdam



Code Construction

Costruzione del codice - Construction du code produit
Bau der Produkt-Code - Construcción del código de producto

LADSW X X X

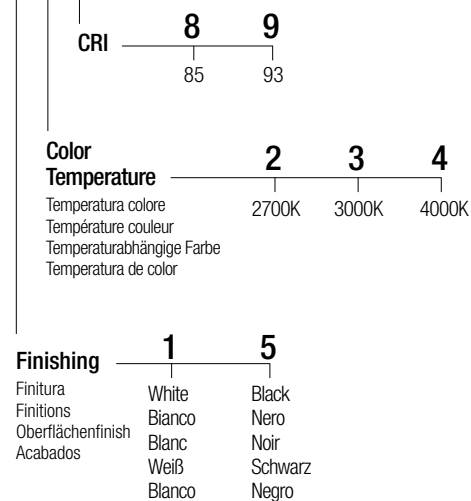

Drivers

Alimentatori - Alimentateurs
Netzteile - Alimentadores

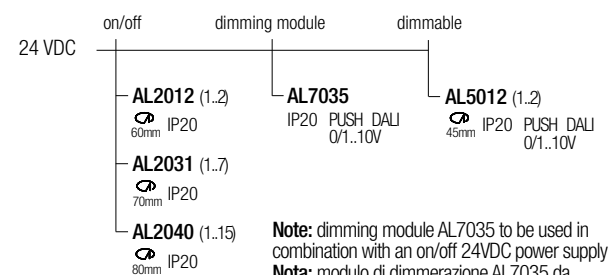

Note: dimming module AL7035 to be used in combination with an on/off 24VDC power supply
Nota: modulo di dimmerazione AL7035 da utilizzare in combinazione con un alimentatore on/off 24VDC
Note: module de variation AL7035 d'intensité à utiliser en combinaison avec une alimentation on/off 24VDC
Anmerkung: Dimmmodul AL7035 zur Verwendung in Kombination mit einem on/off 24VDC-Netzteil
Nota: módulo de regulación AL7035 se utiliza en combinación con una fuente de alimentación on/off 24VDC

Note: versions with extended arm length are available upon request
Nota: versioni con lunghezza del braccetto maggiorata disponibili su richiesta
Note: versions avec longueur du bras majorée disponibles sur demande
Anmerkung: versionen mit erhöhter Armlänge auf Anfrage erhältlich
Nota: Versiones con longitud del brazo aumentada disponible bajo pedido



BULL 10 BASE

design: Lapo Grassellini

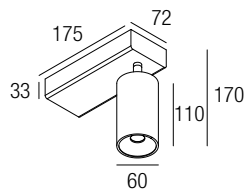

Supply current

Alimentazione
Courant d'alimentation
Stromversorgung
Corriente de alimentación

230 VAC

Power

Potenza
Puissance
Bestuekung
Potencia

10 W

IP20

CCT/CRI/Flux

	CRI85	CRI93
2700K	890 lm	840 lm
3000K	1000 lm	930 lm
4000K	1040 lm	960 lm

CRI85 - CRI93

2-Step MacAdam

Photometric diagrams

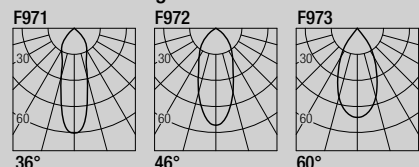

Code Construction

Costruzione del codice - Construction du code produit
Bau der Produkt-Code - Construcción del código de producto

BB1 X X X X X

Beam angle — S — M — W
Apertura di fascio — 36° — 46° — 60°
Angle de faisceau
Strahlwinkel
Angulo del haz

CRI — 8 — 9
85 — 93

Color Temperature — 2 — 3 — 4
Temperatura colore — 2700K — 3000K — 4000K
Température couleur
Temperaturabhängige Farbe
Temperatura de color

Body color — 1 — 2 — 5
Finitura del corpo — White — Grey — Black
Couleur du corps — Blanc — Gris — Noir
Körperfarbe — Weiß — Grau — Schwarz
Color del cuerpo — Blanco — Negro

Color of the cylinder — 1 — 2 — 5
Finitura cilindro — White — Grey — Black
Couleur du cylindre — Blanc — Gris — Noir
Farbe der Zylinder — Weiß — Grau — Schwarz
Color del cilindro — Blanco — Negro

Accessories

Accessori - Accessoires
Zubehör - Accesorios

BUX1NA

Low luminance louver
Filtro antiabbagliamento
Filtre basse luminance
Geringe Leuchtdichte-Filter
Filtro de baja luminancia



SBB101

Milky screen
Schermo opale
Écran opale
Opal-Bildschirm
Pantalla opal



Note: the screen must be ordered together with the lighting fixture - **Nota:** lo schermo deve essere ordinato congiuntamente all'apparecchio - **Note:** l'écran doit être commandé en même temps que l'appareil
Anmerkung: muss der Bildschirm zusammen mit Leuchtörper bestellt werden - **Nota:** la pantalla debe pedirse junta con la luminaria

BUX1FL

Adjustable barn door flaps
Alette paraluca orientabili
Volets orientables anti-éblouissement
Verstellbare Blenden
Aletas direccionales

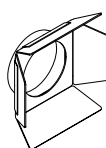

Note: dimmable version available on request
Nota: versioni dimmerabili disponibili su richiesta
Note: version dimmable disponible sur demande
Anmerkung: dimmbare Version auf Anfrage
Nota: versiones regulables disponibles bajo petición



BULL 20 BASE

design: Lapo Grassellini

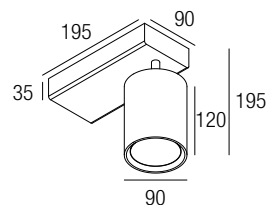

Supply current

Alimentazione
Courant d'alimentation
Stromversorgung
Corriente de alimentación

230 VAC

Power

Potenza
Puissance
Bestuekung
Potencia

20 W

IP20

Photometric diagrams

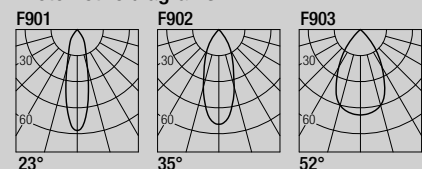

CCT/CRI/Flux

	CRI85	CRI93
2700K	1830 lm	1700 lm
3000K	2000 lm	1830 lm
4000K	2100 lm	1950 lm

CRI85 - CRI93

2-Step MacAdam



Code Construction

Costruzione del codice - Construction du code produit
Bau der Produkt-Code - Construcción del código de producto

BB2 X X X X X

Beam angle — S — M — W
Apertura di fascio — 23° — 35° — 52°
Angle de faisceau
Strahlwinkel
Ángulo del haz

CRI — 8 — 9
85 — 93

Color Temperature — 2 — 3 — 4
Temperatura colore — 2700K — 3000K — 4000K
Température couleur
Temperaturabhängige Farbe
Temperatura de color

Body color — 1 — 2 — 5
Finitura del corpo — White — Grey — Black
Couleur du corps — Blanc — Gris — Noir
Körperfarbe — Weiß — Grau — Schwarz
Color del cuerpo — Blanco — Negro

Color of the cylinder — 1 — 2 — 5
Finitura cilindro — White — Grey — Black
Couleur du cylindre — Blanc — Gris — Noir
Farbe der Zylinder — Weiß — Grau — Schwarz
Color del cilindro — Blanco — Negro

Accessories

Accessori - Accessoires
Zubehör - Accesorios

BUX2NA

Low luminance louver
Filtro antiabbagliamento
Filtre basse luminance
Geringe Leuchtdichte-Filter
Filtro de baja luminancia



BUX2FL

Adjustable barn door flaps
Alette paraluce orientabili
Volets orientables anti-éblouissement
Verstellbare Blenden
Aletas direccionales

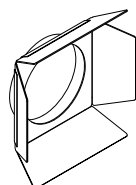

Note: dimmable version available on request

Nota: versioni dimmerabili disponibili su richiesta

Note: version dimmable disponible sur demande

Anmerkung: dimmbare Version auf Anfrage

Nota: versiones regulables disponibles bajo petición



BULL 40 BASE

design: Lapo Grassellini

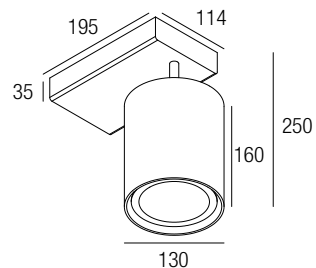

Supply current
 Alimentazione
 Courant d'alimentation
 Stromversorgung
 Corriente de alimentación
230 VAC

Power
 Potenza
 Pouissance
 Bestuekung
 Potencia
40 W

IP20

Photometric diagrams

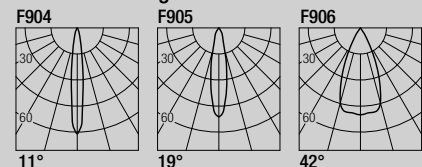

CCT/CRI/Flux

	CRI85	CRI93
2700K	3660 lm	3400 lm
3000K	4000 lm	3660 lm
4000K	4200 lm	3900 lm

CRI85 - CRI93
 2-Step MacAdam



Code Construction

Costruzione del codice - Construction du code produit
 Bau der Produkt-Code - Construcción del código de producto

BB4 X X X X X

Beam angle S M W
 Apertura di fascio 11° 19° 42°
 Angle de faisceau
 Strahlwinkel
 Ángulo del haz

CRI 8 9
 85 93

Color Temperature 2 3 4
 Temperatura colore 2700K 3000K 4000K
 Température couleur
 Temperaturabhängige Farbe
 Temperatura de color

Body color 1 2 5
 Finitura del corpo White Grey Black
 Couleur du corps Bianco Grigio Nero
 Körperfarbe Blanc Gris Noir
 Color del cuerpo Weiß Grau Schwarz
 Blanco Negro

Color of the cylinder 1 2 5
 Finitura cilindro White Grey Black
 Couleur du cylindre Bianco Grigio Nero
 Farbe der Zylinder Blanc Gris Noir
 Color del cilindro Weiß Grau Schwarz
 Blanco Negro

Accessories

Accessori - Accessoires
 Zubehör - Accesorios

BUX4NA

Low luminance louver
 Filtro antiabbagliamento
 Filtre basse luminance
 Geringe Leuchtdichte-Filter
 Filtro de baja luminancia

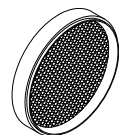

BUX4FL

Adjustable barn door flaps
 Alette paraluze orientabili
 Volets orientables anti-éblouissement
 Verstellbare Blenden
 Aletas direccionales

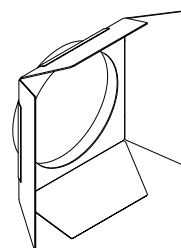

Note: dimmable version available on request
Nota: versioni dimmerabili disponibili su richiesta
Note: version dimmable disponible sur demande
Anmerkung: dimmbare Version auf Anfrage
Nota: versiones regulables disponibles bajo petición



BULL 10 LAY

design: Lapo Grassellini

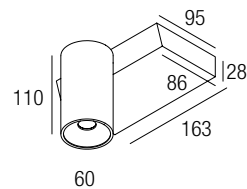

Supply current

Alimentazione
 Courant d'alimentation
 Stromversorgung
 Corriente de alimentación
230 VAC

Power

Potenza
 Pouissance
 Bestuekung
 Potencia
10 W

IP20

Photometric diagrams

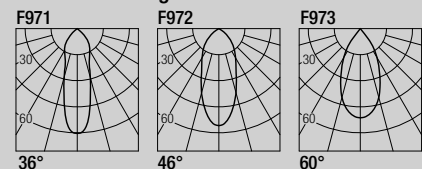

CCT/CRI/Flux

	CRI85	CRI93
2700K	890 lm	840 lm
3000K	1000 lm	930 lm
4000K	1040 lm	960 lm

CRI85 - CRI93
 2-Step MacAdam

Code Construction

Costruzione del codice - Construction du code produit
 Bau der Produkt-Code - Construcción del código de producto

BX1 X X X X X

Beam angle S M W
 Apertura di fascio 36° 46° 60°
 Angle de faisceau
 Strahlwinkel
 Ángulo del haz

CRI 8 9
 85 93

Color Temperature 2 3 4
 Temperatura colore 2700K 3000K 4000K
 Température couleur
 Temperaturabhängige Farbe
 Temperatura de color

Body color 1 2 5
 Finitura del corpo White Grey Black
 Couleur du corps Bianco Grigio Nero
 Körperfarbe Blanc Gris Noir
 Color del cuerpo Weiß Grau Schwarz
 Blanco Negro

Color of the cylinder 1 2 5
 Finitura cilindro White Grey Black
 Couleur du cylindre Bianco Grigio Nero
 Farbe der Zylinder Blanc Gris Noir
 Color del cilindro Weiß Grau Schwarz
 Blanco Negro

Accessories

Accessori - Accessoires
 Zubehör - Accesorios

BUX1NA

Low luminance louver
 Filtro antiabbagliamento
 Filtre basse luminance
 Geringe Leuchtdichte-Filter
 Filtro de baja luminancia



SBX101

Milky screen
 Schermo opale
 Écran opale
 Opal-Bildschirm
 Pantalla opal



Note: the screen must be ordered together with the lighting fixture - **Nota:** lo schermo deve essere ordinato congiuntamente all'apparecchio - **Note:** l'écran doit être commandé en même temps que l'appareil
Anmerkung: muss der Bildschirm zusammen mit Leuchtkörper bestellt werden - **Nota:** la pantalla debe pedirse junta con la luminaria

BUX1FL

Adjustable barn door flaps
 Alette paraluce orientabili
 Volets orientables anti-éblouissement
 Verstellbare Blenden
 Aletas direccionales

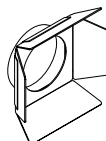

Note: dimmable version available on request
Nota: versioni dimmerabili disponibili su richiesta
Note: version dimmable disponible sur demande
Anmerkung: dimmbare Version auf Anfrage
Nota: versiones regulables disponibles bajo petición

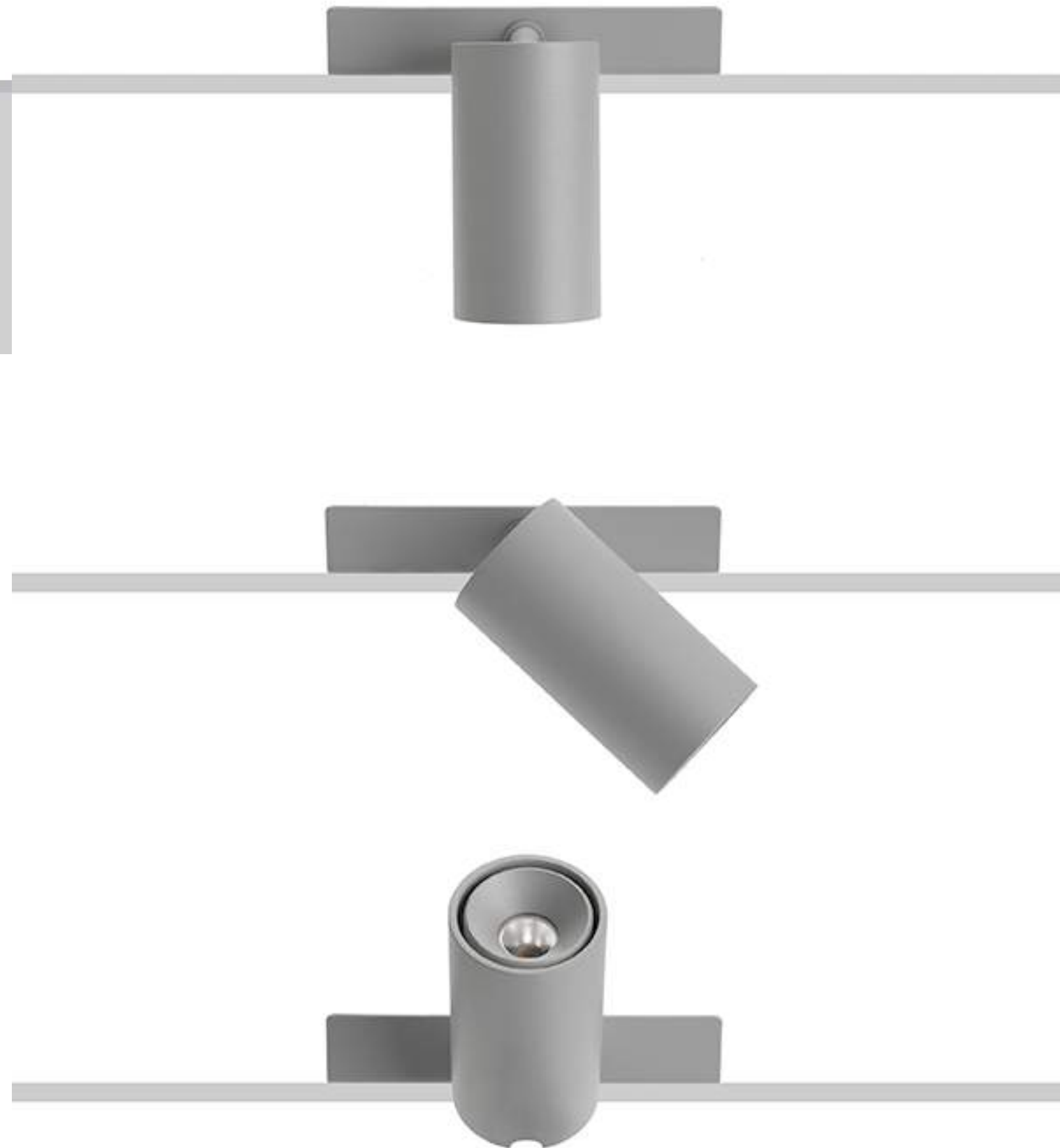

BULL 20 LAY

design: Lapo Grassellini

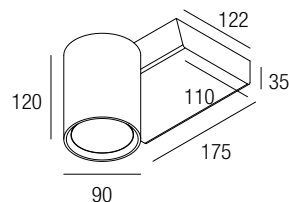

Supply current

Alimentazione
 Courant d'alimentation
 Stromversorgung
 Corriente de alimentación
230 VAC

Power

Potenza
 Pouissance
 Bestuekung
 Potencia
20 W

IP20

CCT/CRI/Flux

	CRI85	CRI93
2700K	1830 lm	1700 lm
3000K	2000 lm	1830 lm
4000K	2100 lm	1950 lm

Photometric diagrams

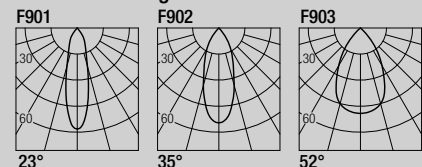

CRI85 - CRI93
 2-Step MacAdam

Code Construction

Costruzione del codice - Construction du code produit
 Bau der Produkt-Code - Construcción del código de producto

BX2 X X X X X

Beam angle	S	M	W
Apertura di fascio Angle de faisceau Strahlwinkel Angulo del haz	23°	35°	52°

CRI	8	9
	85	93

Color Temperature	2	3	4
Temperatura colore Température couleur Temperaturabhängige Farbe Temperatura de color	2700K	3000K	4000K

Body color	1	2	5
Finitura del corpo Couleur du corps Körperfarbe Color del cuerpo	White Bianco Blanc Weiß Blanco	Grey Grigio Gris Grau	Black Nero Noir Schwarz Negro

Color of the cylinder	1	2	5
Finitura cilindro Couleur du cylindre Farbe der Zylinder Color del cilindro	White Bianco Blanc Weiß Blanco	Grey Grigio Gris Grau	Black Nero Noir Schwarz Negro

Accessories

Accessori - Accessoires
 Zubehör - Accesorios

BUX2NA

Low luminance louver
 Filtro antiabbagliamento
 Filtre basse luminance
 Geringe Leuchtdichte-Filter
 Filtro de baja luminancia



BUX2FL

Adjustable barn door flaps
 Alette paraluze orientabili
 Volets orientables anti-éblouissement
 Verstellbare Blenden
 Aletas direccionales

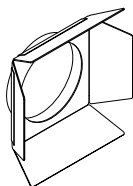

Note: dimmable version available on request

Nota: versioni dimmerabili disponibili su richiesta

Note: version dimmable disponible sur demande

Anmerkung: dimmbare Version auf Anfrage

Nota: versiones regulables disponibles bajo petición



BULL 40 LAY

design: Lapo Grassellini

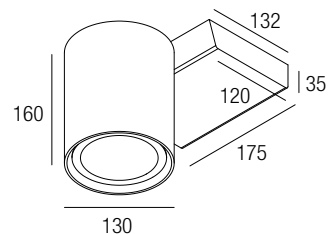

Supply current
 Alimentazione
 Courant d'alimentation
 Stromversorgung
 Corriente de alimentación
230 VAC

Power
 Potenza
 Puissance
 Bestuekung
 Potencia
40 W

IP20

Photometric diagrams

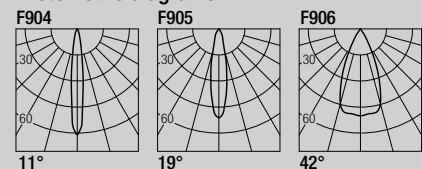

CCT/CRI/Flux

CCT	CRI85	CRI93
2700K	3660 lm	3400 lm
3000K	4000 lm	3660 lm
4000K	4200 lm	3900 lm

CRI85 - CRI93
 2-Step MacAdam

Code Construction

Costruzione del codice - Construction du code produit
 Bau der Produkt-Code - Construcción del código de producto

BX4 X X X X X

Beam angle S M W

Beam angle	S	M	W
Apertura di fascio	11°	19°	42°
Angle de faisceau			
Strahlwinkel			
Ángulo del haz			

CRI 8 9

CRI	8	9
	85	93

Color Temperature 2 3 4

Color Temperature	2	3	4
Temperatura colore	2700K	3000K	4000K
Température couleur			
Temperaturabhängige Farbe			
Temperatura de color			

Body color 1 2 5

Body color	1	2	5
Finitura del corpo	White	Grey	Black
Couleur du corps	Bianco	Grigio	Nero
Körperfarbe	Blanc	Gris	Noir
Color del cuerpo	Weiß	Grau	Schwarz
	Blanco		Negro

Color of the cylinder 1 2 5

Color of the cylinder	1	2	5
Finitura cilindro	White	Grey	Black
Couleur du cylindre	Bianco	Grigio	Nero
Farbe der Zylinder	Blanc	Gris	Noir
Color del cilindro	Weiß	Grau	Schwarz
	Blanco		Negro

Accessories

Accessori - Accessoires
 Zubehör - Accesorios

BUX4NA

Low luminance louver
 Filtro antiabbagliamento
 Filtre basse luminance
 Geringe Leuchtdichte-Filter
 Filtro de baja luminancia

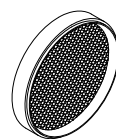

BUX4FL

Adjustable barn door flaps
 Alette paraluze orientabili
 Volets orientables anti-éblouissement
 Verstellbare Blenden
 Aletas direccionales

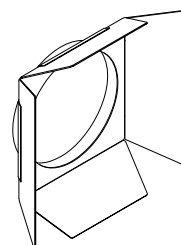

Note: dimmable version available on request
Nota: versioni dimmerabili disponibili su richiesta
Note: version dimmable disponible sur demande
Anmerkung: dimmbare Version auf Anfrage
Nota: versiones regulables disponibles bajo petición

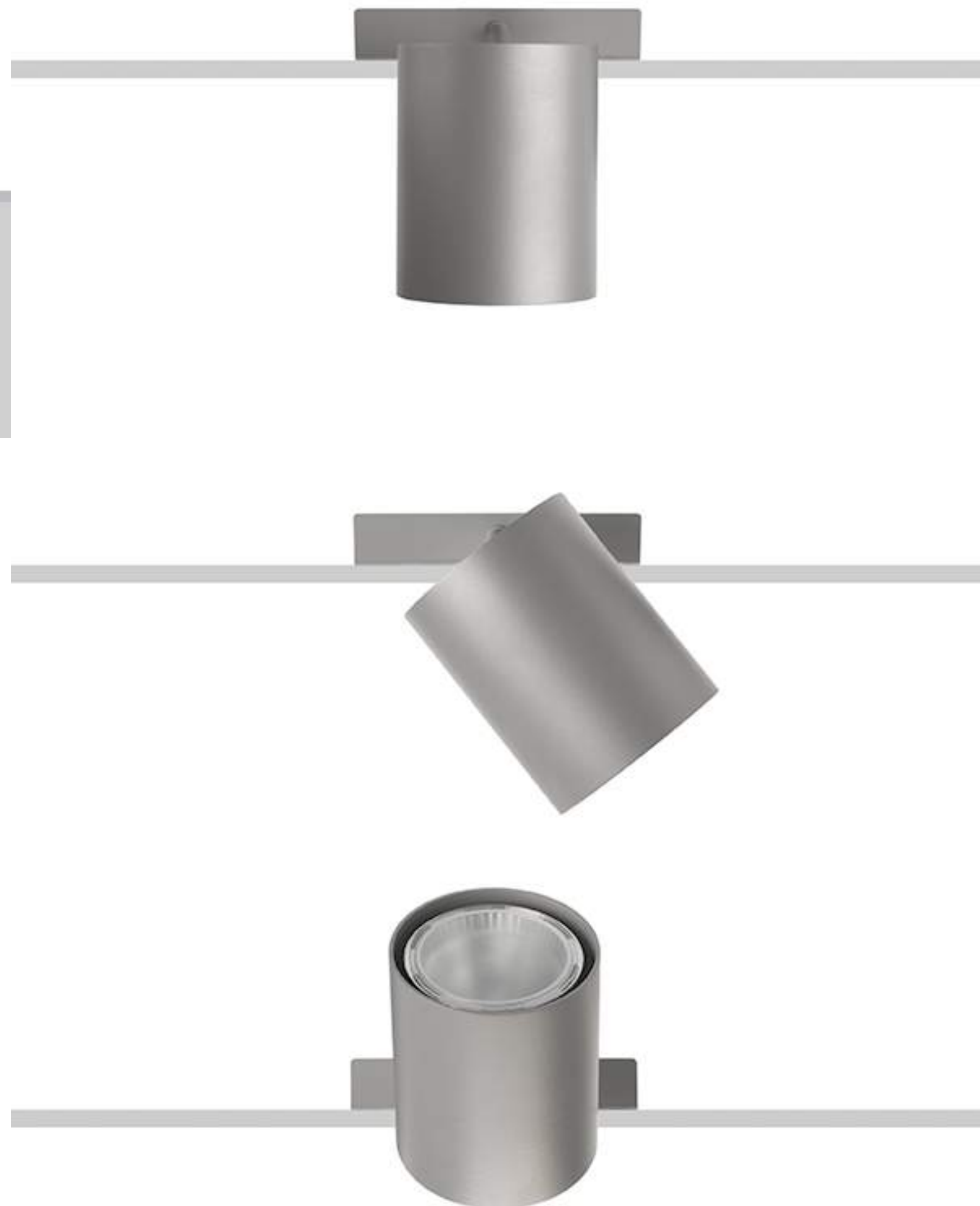

MINISASHA 110 DISPLAY

design: Lapo Grassellini

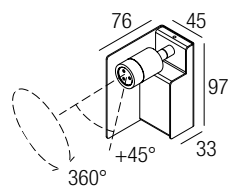

Supply current

Alimentazione
 Courant d'alimentation
 Stromversorgung
 Corriente de alimentación
230 VAC

Power

Potenza
 Pouissance
 Bestuekung
 Potencia
3 W



CCT/CRI/Flux

Photometric diagrams

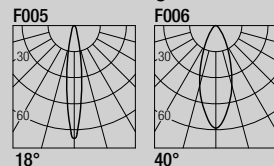

2700K	267 lm
3000K	279 lm
4200K	309 lm
6000K	342 lm

CRI85

2-Step MacAdam



Code Construction

Costruzione del codice - Construction du code produit
 Bau der Produkt-Code - Construcción del código de producto

MSD11 X X X

Color Temperature	0	1	2	3	6	7	8
Temperatura colore	2700K	3000K	4200K	6000K	Blue	Green	Red
Température couleur					Blu	Vert	Rosso
Temperaturabhängige Farbe					Bleu	Vert	Rouge
Temperatura de color					Blau	Grün	Rot
					Azul		Rojo
Beam angle	1	2					
Apertura di fascio	18°	40°					
Angle de faisceau							
Strahlwinkel							
Ángulo del haz							
Finishing	1	2	5				
Finitura	White	Grey	Black				
Finitions	Bianco	Grigio	Nero				
Oberflächenfinish	Blanc	Gris	Noir				
Acabados	Weiß	Grau	Schwarz				
	Blanco		Negro				



MINISASHA 130 DISPLAY

design: Lapo Grassellini

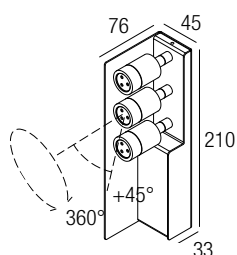

Supply current

Alimentazione
Courant d'alimentation
Stromversorgung
Corriente de alimentación

230 VAC

Power

Potenza
Puissance
Bestuekung
Potencia

3 x 3 W



Photometric diagrams

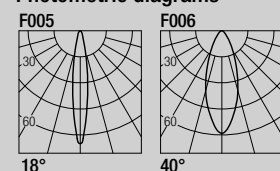

CCT/CRI/Flux

2700K	3 x 267 lm
3000K	3 x 279 lm
4200K	3 x 309 lm
6000K	3 x 342 lm

CRI85

2-Step MacAdam



Code Construction

Costruzione del codice - Construction du code produit
Bau der Produkt-Code - Construcción del código de producto

MSD13 X X X

Color Temperature	0	1	2	3	6	7	8
Temperatura colore	2700K	3000K	4200K	6000K	Blue	Green	Red
Température couleur					Blu	Verde	Rosso
Temperaturabhängige Farbe					Bleu	Vert	Rouge
Temperatura de color					Blau	Grün	Rot
					Azul		Rojo

Beam angle	1	2
Apertura di fascio	18°	40°
Angle de faisceau		
Strahlwinkel		
Ángulo del haz		

Finishing	1	2	5
Finitura	White	Grey	Black
Finitions	Bianco	Grigio	Nero
Oberflächenfinish	Blanc	Gris	Noir
Acabados	Weiß	Grau	Schwarz
	Blanco		Negro



MINISASHA 110 U

design: Lapo Grassellini

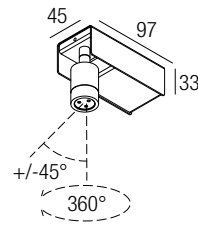
**Supply current**

Alimentazione
Courant d'alimentation
Stromversorgung
Corriente de alimentación

230 VAC**Power**

Potenza
Puissance
Bestuekung
Potencia

3 W

IP20

CCT/CRI/Flux

2700K	267 lm
3000K	279 lm
4200K	309 lm
6000K	342 lm

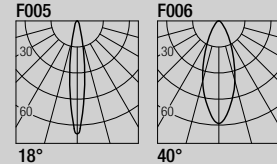
CRI85**2-Step MacAdam****Photometric diagrams****Code Construction**

Costruzione del codice - Construction du code produit
Bau der Produkt-Code - Construcción del código de producto

MSU11 X X X**Color****Temperature**

	0	1	2	3	6	7	8
Temperatura colore	2700K	3000K	4200K	6000K	Blue	Green	Red
Température couleur					Blu	Verde	Rosso
Temperaturabhängige Farbe					Bleu	Vert	Rouge
Temperatura de color					Blau	Grün	Rot
					Azul		Rojo

Beam angle

	1	2
Apertura di fascio	18°	40°
Angle de faisceau		
Strahlwinkel		
Ángulo del haz		

Finishing

	1	2	5
Finitura	White	Grey	Black
Finitions	Bianco	Grigio	Nero
Oberflächenfinish	Blanc	Gris	Noir
Acabados	Weiß	Grau	Schwarz
	Blanco		Negro



MINISASHA 130 U

design: Lapo Grassellini

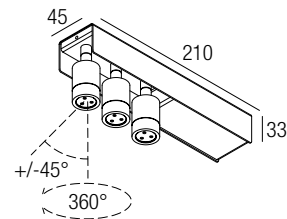

Supply current

Alimentazione
 Courant d'alimentation
 Stromversorgung
 Corriente de alimentación
230 VAC

Power

Potenza
 Pouissance
 Bestuekung
 Potencia
3 x 3 W



CCT/CRI/Flux

2700K — 3 x 267 lm
 3000K — 3 x 279 lm
 4200K — 3 x 309 lm
 6000K — 3 x 342 lm

Photometric diagrams

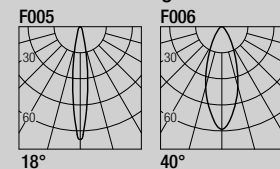

CRI85

2-Step MacAdam



Code Construction

Costruzione del codice - Construction du code produit
 Bau der Produkt-Code - Construcción del código de producto

MSU13 X X X

Color Temperature

	0	1	2	3	6	7	8
Temperatura colore	2700K	3000K	4200K	6000K	Blue	Green	Red
Température couleur					Blu	Verde	Rosso
Temperaturabhängige Farbe					Bleu	Vert	Rouge
Temperatura de color					Blau	Grün	Rot
					Azul		Rojo

Beam angle

	1	2
Apertura di fascio	18°	40°
Angle de faisceau		
Strahlwinkel		
Ángulo del haz		

Finishing

	1	2	5
Finitura	White	Grey	Black
Finitions	Bianco	Grigio	Nero
Oberflächenfinish	Blanc	Gris	Noir
Acabados	Weiß	Grau	Schwarz
	Blanco		Negro

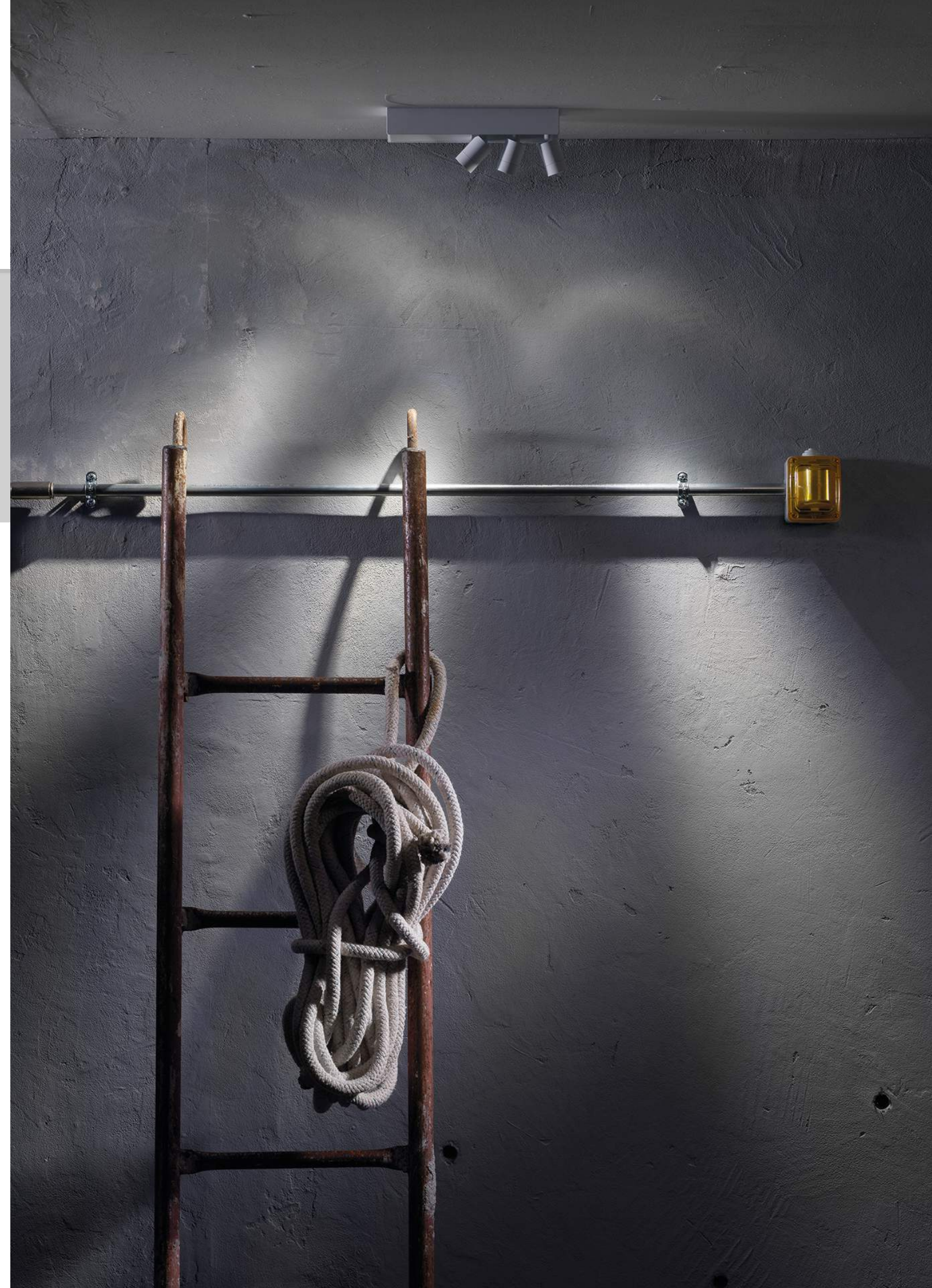

SASHA 110 DISPLAY

design: Lapo Grassellini

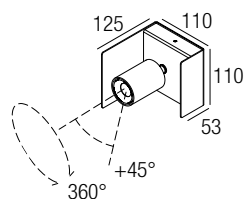

Supply current

Alimentazione
Courant d'alimentation
Stromversorgung
Corriente de alimentación

230 VAC

Power

Potenza
Puissance
Bestuekung
Potencia

8 W



Photometric diagrams

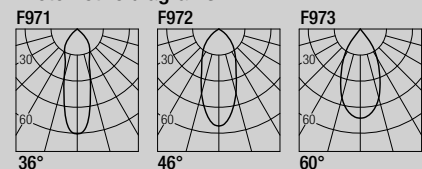

CCT/CRI/Flux

	CRI85	CRI93
2700K	730 lm	690 lm
3000K	830 lm	770 lm
4000K	860 lm	790 lm

CRI85 - CRI93
2-Step MacAdam



Code Construction

Costruzione del codice - Construction du code produit
Bau der Produkt-Code - Construcción del código de producto

SD11 X X X X

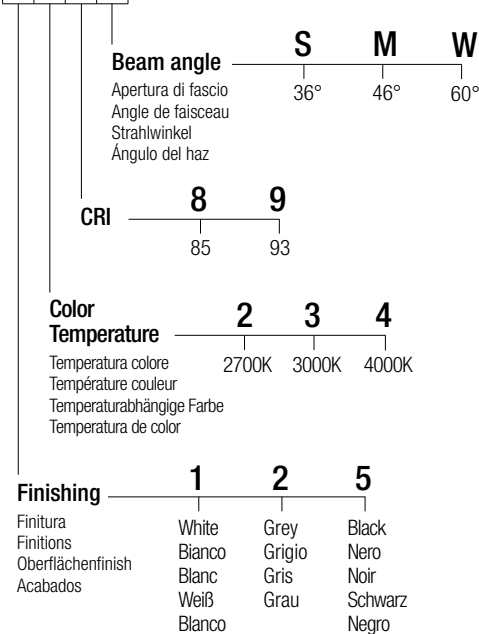

Accessories

Accessori - Accessoires
Zubehör - Accesorios

SSD1101

Milky screen
Schermo opale
Écran opale
Opal-Bildschirm
Pantalla opal

Note: the screen must be ordered together with the lighting fixture - **Nota:** lo schermo deve essere ordinato congiuntamente all'apparecchio - **Note:** l'écran doit être commandé en même temps que l'appareil
Anmerkung: muss der Bildschirm zusammen mit Leuchtkörper bestellt werden - **Nota:** la pantalla debe pedirse junta con la luminaria

SASHA 120 DISPLAY

design: Lapo Grassellini

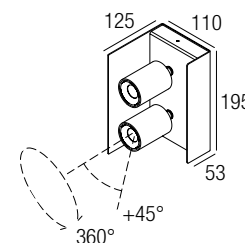

Supply current

Alimentazione
Courant d'alimentation
Stromversorgung
Corriente de alimentación

230 VAC

Power

Potenza
Puissance
Bestuekung
Potencia

2 x 8 W



Photometric diagrams

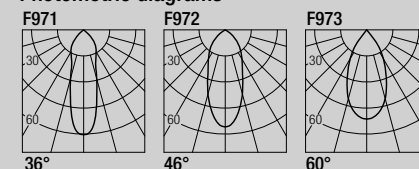

CCT/CRI/Flux

	CRI85	CRI93
2700K	2 x 730 lm	2 x 690 lm
3000K	2 x 830 lm	2 x 770 lm
4000K	2 x 860 lm	2 x 790 lm

CRI85 - CRI93
2-Step MacAdam



Code Construction

Costruzione del codice - Construction du code produit
Bau der Produkt-Code - Construcción del código de producto

SD12 X X X X

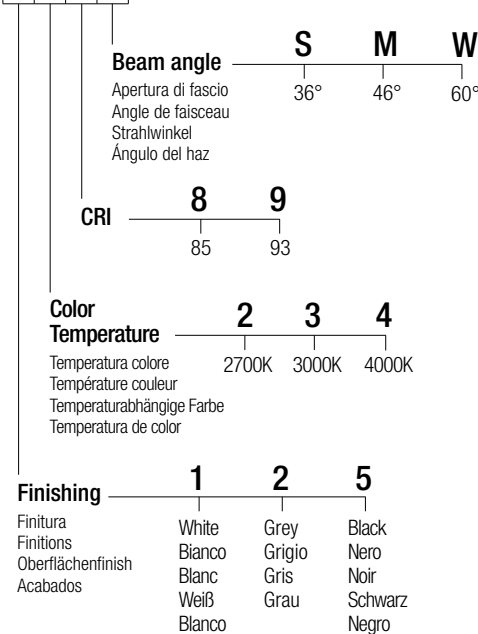

Accessories

Accessori - Accessoires
Zubehör - Accesorios

SSD1201

(2 pcs)
Milky screen
Schermo opale
Écran opale
Opal-Bildschirm
Pantalla opal

Note: the screen must be ordered together with the lighting fixture - **Nota:** lo schermo deve essere ordinato congiuntamente all'apparecchio - **Note:** l'écran doit être commandé en même temps que l'appareil
Anmerkung: muss der Bildschirm zusammen mit Leuchtkörper bestellt werden - **Nota:** la pantalla debe pedirse junta con la luminaria

SASHA 130 DISPLAY

design: Lapo Grassellini

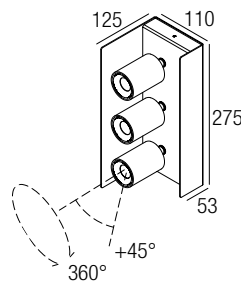

Supply current

Alimentazione
 Courant d'alimentation
 Stromversorgung
 Corriente de alimentación

230 VAC

Power

Potenza
 Puissance
 Bestuekung
 Potencia

3 x 8 W

IP20

Photometric diagrams

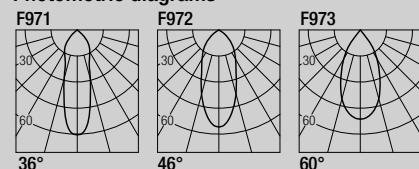

CCT/CRI/Flux

	CRI85	CRI93
2700K	3 x 730 lm	3 x 690 lm
3000K	3 x 830 lm	3 x 770 lm
4000K	3 x 860 lm	3 x 790 lm

CRI85 - CRI93
2-Step MacAdam



Code Construction

Costruzione del codice - Construction du code produit
 Bau der Produkt-Code - Construcción del código de producto

SD13 X X X X

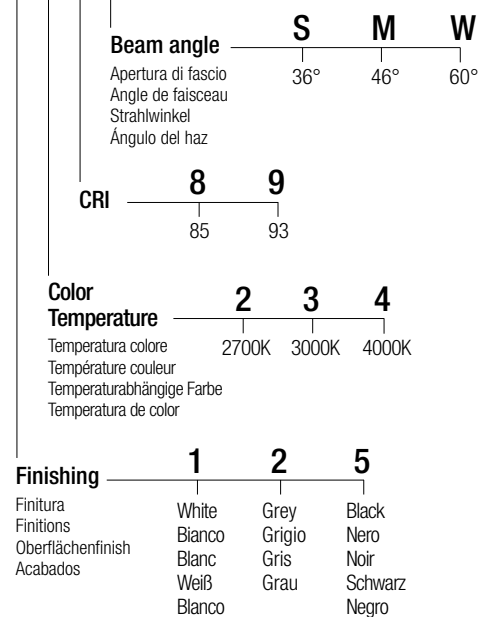

Accessories

Accessori - Accessoires
 Zubehör - Accesorios

SSD1301

(3 pcs)
 Milky screen
 Schermo opale
 Écran opale
 Opal-Bildschirm
 Pantalla opal

Note: the screen must be ordered together with the lighting fixture - **Nota:** lo schermo deve essere ordinato congiuntamente all'apparecchio - **Note:** l'écran doit être commandé en même temps que l'appareil
Anmerkung: muss der Bildschirm zusammen mit Leuchtkörper bestellt werden - **Nota:** la pantalla debe pedirse junta con la luminaria



SASHA 150 DISPLAY

design: Lapo Grassellini

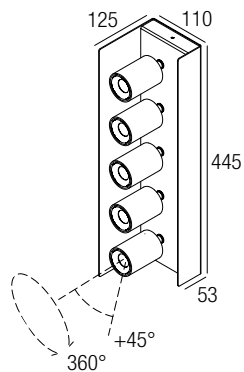

Supply current

Alimentazione
 Courant d'alimentation
 Stromversorgung
 Corriente de alimentación

230 VAC

Power

Potenza
 Pouissance
 Bestuekung
 Potencia

5 x 8 W



Photometric diagrams

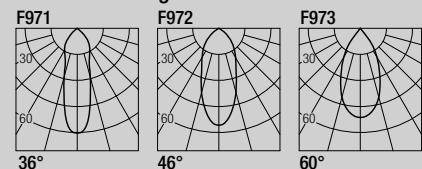

CCT/CRI/Flux

	CRI85	CRI93
2700K	5 x 730 lm	5 x 690 lm
3000K	5 x 830 lm	5 x 770 lm
4000K	5 x 860 lm	5 x 790 lm

CRI85 - CRI93
2-Step MacAdam



Code Construction

Costruzione del codice - Construction du code produit
 Bau der Produkt-Code - Construcción del código de producto

SD15 X X X X

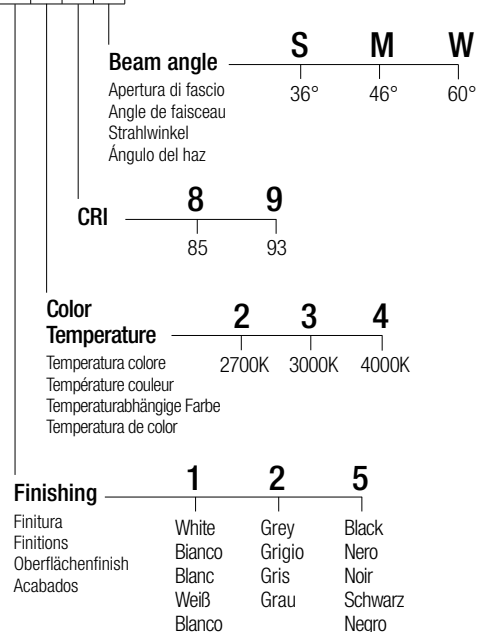

Accessories

Accessori - Accessoires
 Zubehör - Accesorios

SSD1501

(5 pcs)
 Milky screen
 Schermo opale
 Écran opale
 Opal-Bildschirm
 Pantalla opal

Note: the screen must be ordered together with the lighting fixture - **Nota:** lo schermo deve essere ordinato congiuntamente all'apparecchio - **Note:** l'écran doit être commandé en même temps que l'appareil
Anmerkung: muss der Bildschirm zusammen mit Leuchtkörper bestellt werden - **Nota:** la pantalla debe pedirse junta con la luminaria



SASHA 110 U

design: Lapo Grassellini

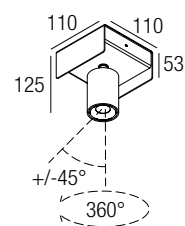

Supply current

Alimentazione
Courant d'alimentation
Stromversorgung
Corriente de alimentación

230 VAC

Power

Potenza
Puissance
Bestuekung
Potencia

8 W



Photometric diagrams

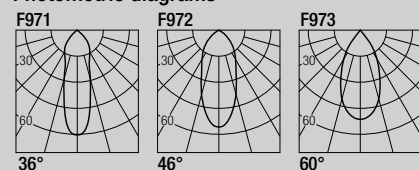

CCT/CRI/Flux

	CRI85	CRI93
2700K	730 lm	690 lm
3000K	830 lm	770 lm
4000K	860 lm	790 lm

CRI85 - CRI93
2-Step MacAdam



SASHA 120 U

design: Lapo Grassellini

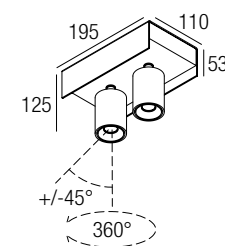

Supply current

Alimentazione
Courant d'alimentation
Stromversorgung
Corriente de alimentación

230 VAC

Power

Potenza
Puissance
Bestuekung
Potencia

2 x 8 W



Photometric diagrams

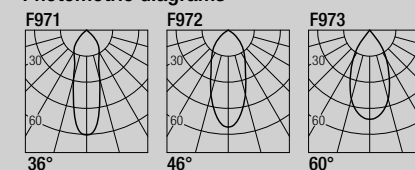

CCT/CRI/Flux

	CRI85	CRI93
2700K	2 x 730 lm	2 x 690 lm
3000K	2 x 830 lm	2 x 770 lm
4000K	2 x 860 lm	2 x 790 lm

CRI85 - CRI93
2-Step MacAdam



Code Construction

Costruzione del codice - Construction du code produit
Bau der Produkt-Code - Construcción del código de producto

SU11 X X X X

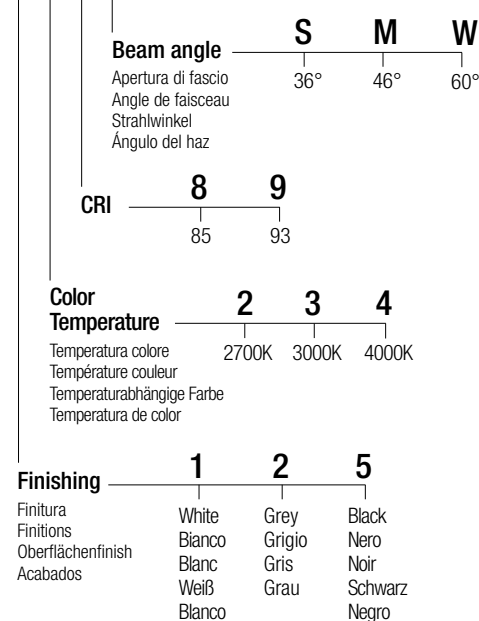

Accessories

Accessori - Accessoires
Zubehör - Accesorios

SSU1101

Milky screen
Schermo opale
Écran opale
Opal-Bildschirm
Pantalla opal

Note: the screen must be ordered together with the lighting fixture - **Nota:** lo schermo deve essere ordinato congiuntamente all'apparecchio - **Note:** l'écran doit être commandé en même temps que l'appareil
Anmerkung: muss der Bildschirm zusammen mit Leuchtkörper bestellt werden - **Nota:** la pantalla debe pedirse junta con la luminaria

Code Construction

Costruzione del codice - Construction du code produit
Bau der Produkt-Code - Construcción del código de producto

SU12 X X X X

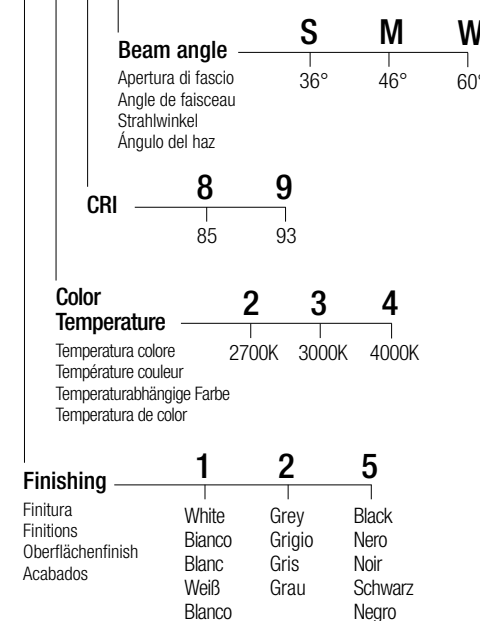

Accessories

Accessori - Accessoires
Zubehör - Accesorios

SSU1201

(2 pcs)
Milky screen
Schermo opale
Écran opale
Opal-Bildschirm
Pantalla opal

Note: the screen must be ordered together with the lighting fixture - **Nota:** lo schermo deve essere ordinato congiuntamente all'apparecchio - **Note:** l'écran doit être commandé en même temps que l'appareil
Anmerkung: muss der Bildschirm zusammen mit Leuchtkörper bestellt werden - **Nota:** la pantalla debe pedirse junta con la luminaria

SASHA 130 U

design: Lapo Grassellini

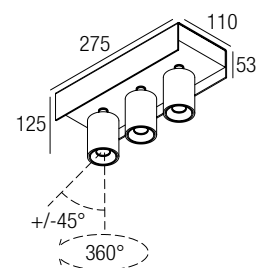

Supply current

Alimentazione
 Courant d'alimentation
 Stromversorgung
 Corriente de alimentación
230 VAC

Power

Potenza
 Pouissance
 Bestuekung
 Potencia
3 x 8 W

IP20

CCT/CRI/Flux

	CRI85	CRI93
2700K	3 x 730 lm	3 x 690 lm
3000K	3 x 830 lm	3 x 770 lm
4000K	3 x 860 lm	3 x 790 lm

Photometric diagrams

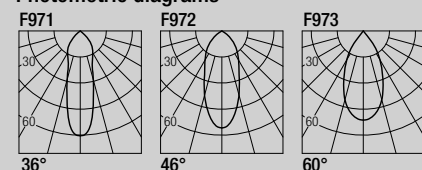

CRI85 - CRI93
 2-Step MacAdam



Code Construction

Costruzione del codice - Construction du code produit
 Bau der Produkt-Code - Construcción del código de producto

SU13 X X X X

Beam angle — S M W
 Apertura di fascio 36° 46° 60°
 Angle de faisceau
 Strahlwinkel
 Ángulo del haz

CRI — 8 9
 85 93

Color Temperature — 2 3 4
 Temperatura colore 2700K 3000K 4000K
 Température couleur
 Temperaturabhängige Farbe
 Temperatura de color

Finishing — 1 2 5
 Finitura White Grey Black
 Finitions Bianco Grigio Nero
 Oberflächenfinish Blanc Gris Noir
 Acabados Weiß Grau Schwarz
 Blanco Negro

Accessories

Accessori - Accessoires
 Zubehör - Accesorios

SSU1301

(3 pcs)
 Milky screen
 Schermo opale
 Écran opale
 Opal-Bildschirm
 Pantalla opal

Note: the screen must be ordered together with the lighting fixture - **Nota:** lo schermo deve essere ordinato congiuntamente all'apparecchio - **Note:** l'écran doit être commandé en même temps que l'appareil
Anmerkung: muss der Bildschirm zusammen mit Leuchtkörper bestellt werden - **Nota:** la pantalla debe pedirse junta con la luminaria



SASHA 150 U

design: Lapo Grassellini

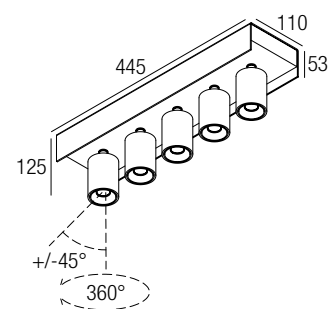

Supply current

Alimentazione
 Courant d'alimentation
 Stromversorgung
 Corriente de alimentación
230 VAC

Power

Potenza
 Pouissance
 Bestuekung
 Potencia
5 x 8 W

IP20

Photometric diagrams

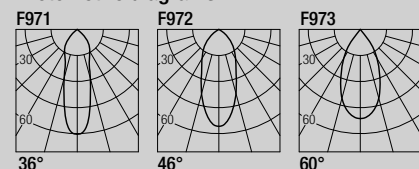

CCT/CRI/Flux

	CRI85	CRI93
2700K	5 x 730 lm	5 x 690 lm
3000K	5 x 830 lm	5 x 770 lm
4000K	5 x 860 lm	5 x 790 lm



CRI85 - CRI93
 2-Step MacAdam

Code Construction

Costruzione del codice - Construction du code produit
 Bau der Produkt-Code - Construcción del código de producto

SU15 X X X X

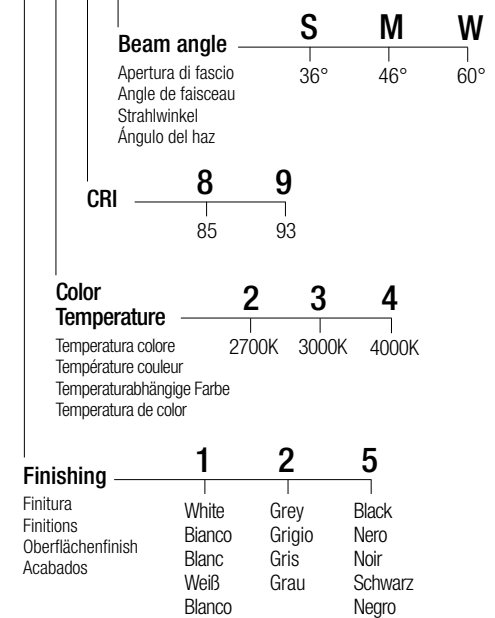

Accessories

Accessori - Accessoires
 Zubehör - Accesorios

SSU1501

(5 pcs)
 Milky screen
 Schermo opale
 Écran opale
 Opal-Bildschirm
 Pantalla opal

Note: the screen must be ordered together with the lighting fixture - **Nota:** lo schermo deve essere ordinato congiuntamente all'apparecchio - **Note:** l'écran doit être commandé en même temps que l'appareil
Anmerkung: muss der Bildschirm zusammen mit Leuchtörper bestellt werden - **Nota:** la pantalla debe pedirse junta con la luminaria



SWAN 10

design: Lapo Grassellini

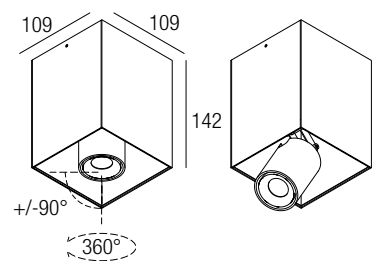

Supply current

Alimentazione
Courant d'alimentation
Stromversorgung
Corriente de alimentación

230 VAC

Power

Potenza
Puissance
Bestuekung
Potencia

10 W



CCT/CRI/Flux

	CRI85	CRI93
2700K	890 lm	840 lm
3000K	1000 lm	930 lm
4000K	1040 lm	960 lm

Photometric diagrams

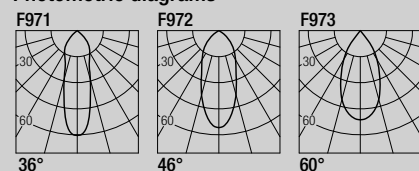

CRI85 - CRI93

2-Step MacAdam



Code Construction

Costruzione del codice - Construction du code produit
Bau der Produkt-Code - Construcción del código de producto

SW1 X X X X

Beam angle

	S	M	W
Apertura di fascio Angle de faisceau Strahlwinkel Ángulo del haz	36°	46°	60°

CRI

8	9
85	93

Color Temperature

2	3	4
2700K	3000K	4000K
Temperatura colore Température couleur Temperaturabhängige Farbe Temperatura de color		

Finishing

1	2	5
White Bianco Blanc Weiß Blanco	Grey Grigio Gris Grau	Black Nero Noir Schwarz Negro
Finitura Finitions Oberflächenfinish Acabados		

Accessories

Accessori - Accessoires
Zubehör - Accesorios

SSW101

Milky screen
Schermo opale
Écran opale
Opal-Bildschirm
Pantalla opal

Note: the screen must be ordered together with the lighting fixture - **Nota:** lo schermo deve essere ordinato congiuntamente all'apparecchio - **Note:** l'écran doit être commandé en même temps que l'appareil

Anmerkung: muss der Bildschirm zusammen mit Leuchtkörper bestellt werden - **Nota:** la pantalla debe pedirse junta con la luminaria



SWAN X120

design: Lapo Grassellini

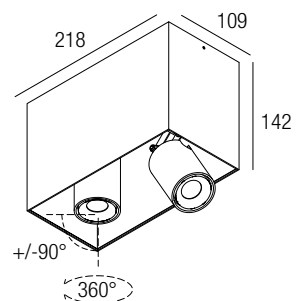

Supply current

Alimentazione
 Courant d'alimentation
 Stromversorgung
 Corriente de alimentación
230 VAC

Power

Potenza
 Pouissance
 Bestuekung
 Potencia
2 x 10 W



Photometric diagrams

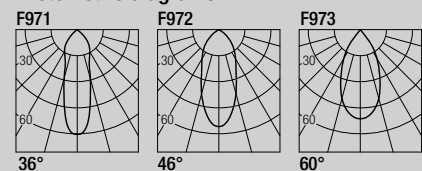

CCT/CRI/Flux

	CRI85	CRI93
2700K	2 x 890 lm	2 x 840 lm
3000K	2 x 1000 lm	2 x 930 lm
4000K	2 x 1040 lm	2 x 960 lm

CRI85 - CRI93
2-Step MacAdam



Code Construction

Costruzione del codice - Construction du code produit
 Bau der Produkt-Code - Construcción del código de producto

SWX12 X X X X

Beam angle	S	M	W
Apertura di fascio Angle de faisceau Strahlwinkel Angulo del haz	36°	46°	60°

CRI	8	9
	85	93

Color Temperature	2	3	4
Temperatura colore Température couleur Temperaturabhängige Farbe Temperatura de color	2700K	3000K	4000K

Finishing	1	2	5
Finitura Finitions Oberflächenfinish Acabados	White Bianco Blanc Weiß Blanco	Grey Grigio Gris Grau	Black Nero Noir Schwarz Negro

Accessories

Accessori - Accessoires
 Zubehör - Accesorios

SSWX1201

(2 pcs)
 Milky screen
 Schermo opale
 Écran opale
 Opal-Bildschirm
 Pantalla opal

Note: the screen must be ordered together with the lighting fixture - **Nota:** lo schermo deve essere ordinato congiuntamente all'apparecchio - **Note:** l'écran doit être commandé en même temps que l'appareil
Anmerkung: muss der Bildschirm zusammen mit Leuchtkörper bestellt werden - **Nota:** la pantalla debe pedirse junta con la luminaria



SWAN X130

design: Lapo Grassellini

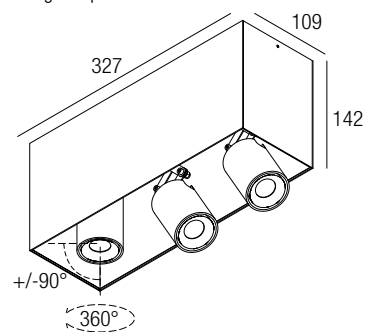

Supply current

Alimentazione
Courant d'alimentation
Stromversorgung
Corriente de alimentación
230 VAC

Power

Potenza
Puissance
Bestuekung
Potencia
3 x 10 W



CCT/CRI/Flux

	CRI85	CRI93
2700K	3 x 890 lm	3 x 840 lm
3000K	3 x 1000 lm	3 x 930 lm
4000K	3 x 1040 lm	3 x 960 lm

CRI85 - CRI93
2-Step MacAdam

Photometric diagrams

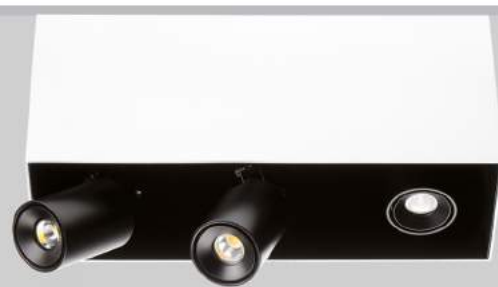
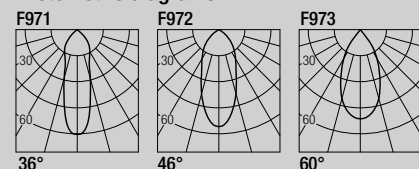

Code Construction

Costruzione del codice - Construction du code produit
Bau der Produkt-Code - Construcción del código de producto

SWX13 X X X X

Beam angle	S	M	W
Apertura di fascio Angle de faisceau Strahlwinkel Ángulo del haz	36°	46°	60°

CRI	8	9
	85	93

Color Temperature	2	3	4
Temperatura colore Température couleur Temperaturabhängige Farbe Temperatura de color	2700K	3000K	4000K

Finishing	1	2	5
Finitura Finitions Oberflächenfinish Acabados	White Bianco Blanc Weiß Blanco	Grey Grigio Gris Grau	Black Nero Noir Schwarz Negro

Accessories

Accessori - Accessoires
Zubehör - Accesorios

SSWX1301

(3 pcs)

Milky screen
Schermo opale
Écran opale
Opal-Bildschirm
Pantalla opal

Note: the screen must be ordered together with the lighting fixture - **Nota:** lo schermo deve essere ordinato congiuntamente all'apparecchio - **Note:** l'écran doit être commandé en même temps que l'appareil
Anmerkung: muss der Bildschirm zusammen mit Leuchtkörper bestellt werden - **Nota:** la pantalla debe pedirse junta con la luminaria



TULIP

design: Lapo Grassellini

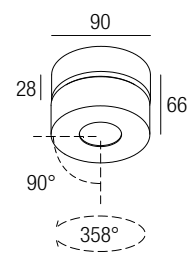
**Supply current**

Alimentazione
Courant d'alimentation
Stromversorgung
Corriente de alimentación

250 mA (V, 36V)**Power**

Potenza
Puissance
Bestuekung
Potencia

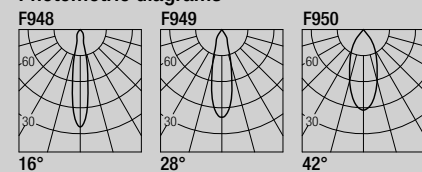
10 W**Photometric diagrams****CCT/CRI/Flux**

	CRI85	CRI93
2700K	890 lm	840 lm
3000K	1000 lm	930 lm
4000K	1040 lm	960 lm

CRI85 - CRI93
2-Step MacAdam

**Code Construction**

Costruzione del codice - Construction du code produit
Bau der Produkt-Code - Construcción del código de producto

TP1 X X X X**Beam angle**

Apertura di fascio
Angle de faisceau
Strahlwinkel
Ángulo del haz

S M W
16° 28° 42°

CRI

8 9
85 93

Color Temperature

Temperatura colore
Température couleur
Temperaturabhängige Farbe
Temperatura de color

2 3 4
2700K 3000K 4000K

Finishing

Finitura
Finitions
Oberflächenfinish
Acabados

1 2 5
White Grey Black
Bianco Grigio Nero
Blanc Gris Noir
Weiß Schwarz
Blanco Negro

Drivers

Alimentatori - Alimentateurs
Netzteile - Alimentadores

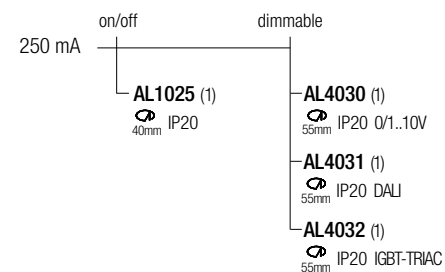

CRIS

design: Roberto Mantovani

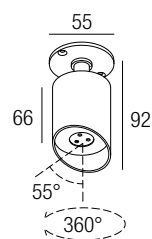

Supply current

Alimentazione
Courant d'alimentation
Stromversorgung
Corriente de alimentación

350-500 mA (V_i 8,7V)

Power

Potenza
Puissance
Bestuekung
Potencia

3-6 W

Series wiring

Cablaggio in serie
Câblage en série
Verkabelung in Serie
Cableado en serie



CCT/CRI/Flux

	350mA	500mA
2700K	267 lm	384 lm
3000K	279 lm	400 lm
4200K	309 lm	462 lm
6000K	342 lm	495 lm

CRI85 - CRI93

2-Step MacAdam

Photometric diagrams

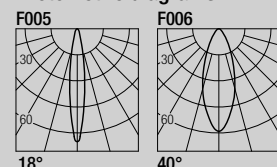

Code Construction

Costruzione del codice - Construction du code produit
Bau der Produkt-Code - Construcción del código de producto

CR2 X X X

Beam angle

S	F
18°	40°

Apertura di fascio
Angle de faisceau
Strahlwinkel
Ángulo del haz

Color Temperature

0	1	2	3	6	7	8
2700K	3000K	4200K	6000K	Blue	Green	Red
				Blu	Verde	Rosso
				Bleu	Vert	Rouge
				Blau	Grün	Rot
				Azul		Rojo

Temperatura colore
Température couleur
Temperaturabhängige Farbe
Temperatura de color

Finishing

1	2	5
White	Grey	Black
Bianco	Grigio	Nero
Blanc	Gris	Noir
Weiß	Grau	Schwarz
Blanco		Negro

Finitura
Finitions
Oberflächenfinish
Acabados

Accessories

Accessori - Accessoires
Zubehör - Accesorios

CR0100 CR0200 CR0500

White	Grey	Black
Bianco	Grigio	Nero
Blanc	Gris	Noir
Weiß	Grau	Schwarz
Blanco		Negro

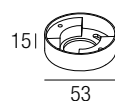

AL7022

24VDC/500mA constant current converter
Convertitore 24VDC/500mA corrente costante
Convertisseur 24VDC/500mA courant constant
24VDC/500mA konstanter Strom konverter
Convertidor 24VDC/500mA corriente constante

Drivers

Alimentatori - Alimentateurs
Netzteile - Alimentadores

350 mA		500 mA	
on/off	dimnable	on/off	dimnable
AL1034 (1..3) 30mm IP20	AL4000 (1..4) 72mm IP20 PUSH 0/1..10V	AL1074 (1..2) 30mm IP20	AL4010 (1..4) 72mm IP20 PUSH 0/1..10V
AL1035 (1..3) 40mm IP20	AL4051 (1..4) 72mm IP20 DALI 2	AL1077 (1..2) 40mm IP20	AL4151 (1..4) 72mm IP20 DALI 2
AL1037 (1..5) 55mm IP20 S.P.	AL4053 (1..4) 56mm IP20 PUSH IGBT-TRIAC	AL1084 (1..3) 55mm IP20 S.P.	AL4153 (1..4) 56mm IP20 PUSH IGBT-TRIAC



PUFF

design: Lapo Grassellini

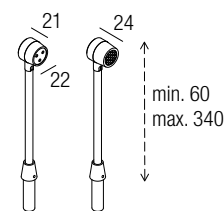

Supply current

Alimentazione
Courant d'alimentation
Stromversorgung
Corriente de alimentación
250 mA (V_r 8,7V)

Power

Potenza
Puissance
Bestuekung
Potencia
2 W

Series wiring

Cablaggio in serie
Câblage en série
Verkabelung in Serie
Cableado en serie



CCT/CRI/Flux

2700K	270 lm
3000K	300 lm
4200K	310 lm
6000K	340 lm

CRI85

2-Step MacAdam

Photometric diagrams

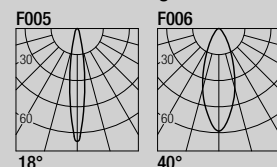

Code Construction

Costruzione del codice - Construction du code produit
Bau der Produkt-Code - Construcción del código de producto

PU X X X X

Low luminance louver

Filtro antiabbagliamento Filtre basse luminance Geringe Leuchtdichte-Filter Filtro de baja luminancia	L Yes Si Oui Ja Sí	0 No Non Nein
--	--	-------------------------------

Color Temperature

	0	1	2	3	6	7	8
Temperatura colore Température couleur Temperaturabhängige Farbe Temperatura de color	2700K	3000K	4200K	6000K	Blue Blu Bleu Blau Azul	Green Verde Vert Grün	Red Rosso Rouge Rot Rojo

Beam angle

Apertura di fascio Angle de faisceau Strahlwinkel Ángulo del haz	1 18°	2 40°
---	-----------------	-----------------

Finishing

Finitura Finitions Oberflächenfinish Acabados	1 White Bianco Blanc Weiß Blanco	2 Grey Grigio Gris Grau	5 Black Nero Noir Schwarz Negro
--	--	--	---

Drivers

Alimentatori - Alimentateurs
Netzteile - Alimentadores

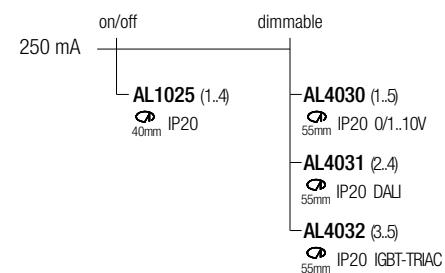

GAGARIN PT2

design: Roberto Mantovani

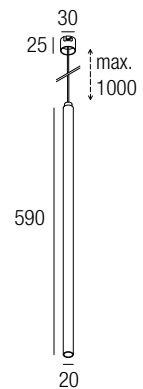

Supply current

Alimentazione
Courant d'alimentation
Stromversorgung
Corriente de alimentación
500 mA (V, 2,9V)

Power

Potenza
Puissance
Bestuekung
Potencia
2 W

Series wiring

Cablaggio in serie
Câblage en série
Verkabelung in Serie
Cableado en serie



CCT/CRI/Flux

2700K — 128 lm
3000K — 133 lm
4200K — 154 lm

Photometric diagrams

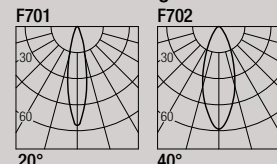

CRI85

2-Step MacAdam



GAGARIN PT6

design: Roberto Mantovani

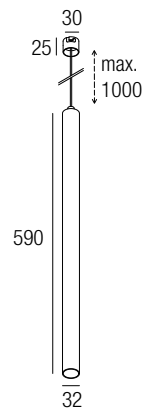

Supply current

Alimentazione
Courant d'alimentation
Stromversorgung
Corriente de alimentación
500 mA (V, 9V)

Power

Potenza
Puissance
Bestuekung
Potencia
6 W

Series wiring

Cablaggio in serie
Câblage en série
Verkabelung in Serie
Cableado en serie



CCT/CRI/Flux

2700K — 540 lm
3000K — 600 lm
4000K — 620 lm

Photometric diagrams

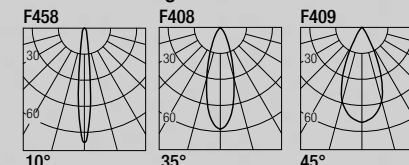

CRI98

2-Step MacAdam



Code Construction

Costruzione del codice - Construction du code produit
Bau der Produkt-Code - Construcción del código de producto

GPT2 X X X

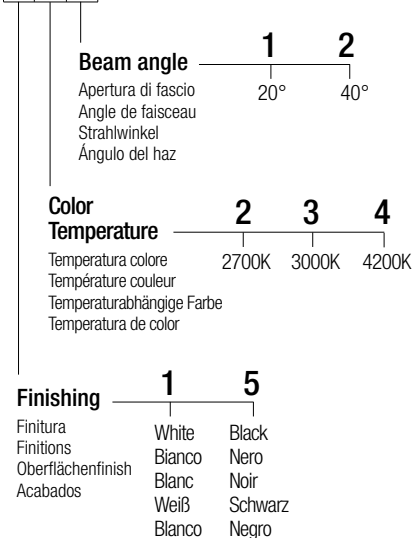

Accessories

Accessori - Accessoires
Zubehör - Accesorios

ZQC001 ZQC001B

White Bianco Blanc Weiß Blanco
Black Nero Noir Schwarz Negro

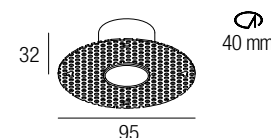

Plasterboard recessing frame
Flangia per cartongesso
Boîtier d'encastrement pour plaques de plâtre
Gehäuses Trockenbau
Cajetín para placas de yeso

Note: cable cut to measure on request
Nota: cavo a misura disponibile su richiesta
Note: câble sur mesure disponible sur demande
Anmerkung: kundenspezifisches Kabel auf Anfrage erhältlich
Nota: cable a medida disponible a petición

Drivers

Alimentatori - Alimentateurs
Netzteile - Alimentadores

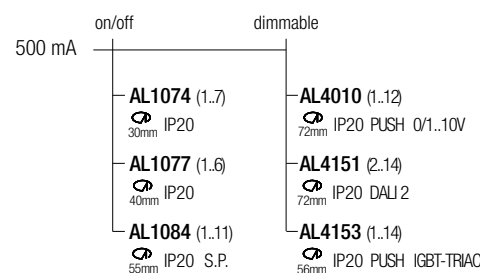

Code Construction

Costruzione del codice - Construction du code produit
Bau der Produkt-Code - Construcción del código de producto

GPT6 X X X

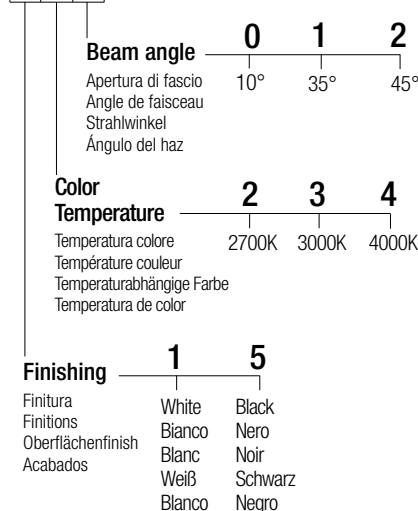

Drivers

Alimentatori - Alimentateurs
Netzteile - Alimentadores

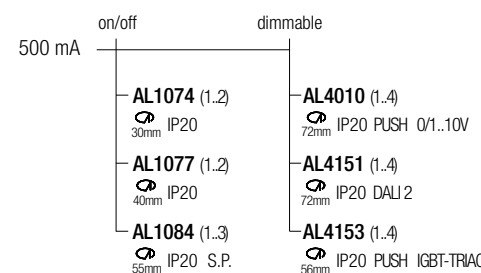

Accessories

Accessori - Accessoires
Zubehör - Accesorios

ZQC001 ZQC001B

White Bianco Blanc Weiß Blanco
Black Nero Noir Schwarz Negro

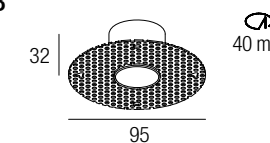

Plasterboard recessing frame
Flangia per cartongesso
Boîtier d'encastrement pour plaques de plâtre
Gehäuses Trockenbau
Cajetín para placas de yeso

LJ02 White Bianco Blanc Weiß Blanco
LJ02B Black Nero Noir Schwarz Negro
SJ02 White Bianco Blanc Weiß Blanco
SJ02B Black Nero Noir Schwarz Negro

Low luminance louver
Filtro antiabbagliamento
Filtre basse luminance
Geringe Leuchtdichte-Filter
Filtro de baja luminancia

Milky screen
Schermo opale
Écran opale
Opal-Bildschirm
Pantalla opal

Note: cable cut to measure on request
Nota: cavo a misura disponibile su richiesta
Note: câble sur mesure disponible sur demande
Anmerkung: kundenspezifisches Kabel auf Anfrage erhältlich
Nota: cable a medida disponible a petición

GAGARIN PT10

design: Roberto Mantovani

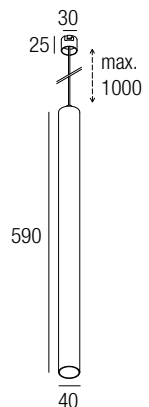

Supply current

Alimentazione
Courant d'alimentation
Stromversorgung
Corriente de alimentación

500 mA (V, 18V)

Power

Potenza
Puissance
Bestuekung
Potencia

10 W

Series wiring

Cablaggio in serie
Câblage en série
Verkabelung in Serie
Cableado en serie



Photometric diagrams

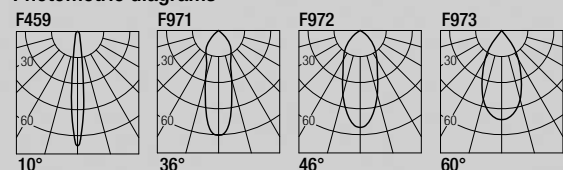

CCT/CRI/Flux

	CRI85	CRI93
2700K	890 lm	840 lm
3000K	1000 lm	930 lm
4000K	1040 lm	960 lm

CRI85 - CRI93
2-Step MacAdam



Code Construction

Costruzione del codice - Construction du code produit
Bau der Produkt-Code - Construcción del código de producto

GPT1 X X X X

Beam angle

	N	S	M	W	X
Apertura di fascio Angle de faisceau Strahlwinkel Ángulo del haz	10°	36°	46°	60°	10-55°

CRI	8	9
	85	93

Color Temperature

	2	3	4
Temperatura colore Température couleur Temperaturabhängige Farbe Temperatura de color	2700K	3000K	4000K

Finishing

	1	5
Finitura Finitions Oberflächenfinish Acabados	White Bianco Blanc Weiß Blanco	Black Nero Noir Schwarz Negro

Accessories

Accessori - Accessoires
Zubehör - Accesorios

ZQC001 ZQC001B

White Bianco Blanc Weiß Blanco	Black Nero Noir Schwarz Negro
--	---

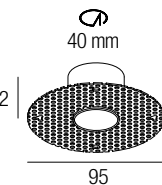

Plasterboard recessing frame
Flangia per cartongesso
Boîtier d'encastrement pour plaques de plâtre
Gehäuses Trockenbau
Cajetín para placas de yeso

LJ01 LJ01B

White Bianco Blanc Weiß Blanco	Black Nero Noir Schwarz Negro
--	---

Low luminance louver
Filtro antiabbagliamento
Filtre basse luminance
Geringe Leuchtdichte-Filter
Filtro de baja luminancia

SJ01 SJ01B

White Bianco Blanc Weiß Blanco	Black Nero Noir Schwarz Negro
--	---

Milky screen
Schermo opale
Écran opale
Opal-Bildschirm
Pantalla opal

Note: the filter and the screen are not available in 10-55° adjustable optics version - **Nota:** il filtro e lo schermo non sono disponibili nella versione ad ottica regolabile 10-55° - **Note:** le filtre et l'écran ne sont pas disponibles dans la version à optique réglable 10-55° - **Anmerkung:** Filter und Bildschirm sind in der einstellbaren optischen Version 10-55° nicht verfügbar - **Nota:** el filtro y la pantalla no están disponibles en la versión de óptica ajustable 10-55°

Drivers

Alimentatori - Alimentateurs
Netzteile - Alimentadores

500 mA	on/off	dimnable
AL1074 (1)	30mm IP20	AL4010 (1.2) 72mm IP20 PUSH 0/1..10V
AL1077 (1)	40mm IP20	AL4151 (1.2) 72mm IP20 DALI 2
AL1084 (1.2)	55mm IP20 S.P.	AL4153 (1.2) 56mm IP20 PUSH IGBT-TRIAC

Note: cable cut to measure on request

Nota: cavo a misura disponibile su richiesta

Note: câble sur mesure disponible sur demande

Anmerkung: kundenspezifisches Kabel auf Anfrage erhältlich

Nota: cable a medida disponible a petición



JOS PT2

design: Roberto Mantovani

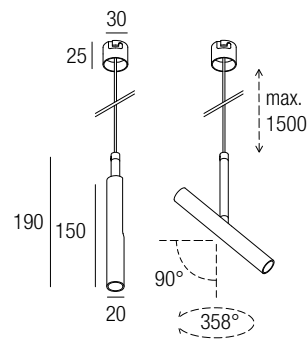

Supply current
Alimentazione
Courant d'alimentation
Stromversorgung
Corriente de alimentación
500 mA (V_i 2,9V)

Power
Potenza
Puissance
Bestuekung
Potencia
2 W

Series wiring
Cablaggio in serie
Câblage en série
Verkabelung in Serie
Cableado en serie



CCT/CRI/Flux

2700K — 128 lm
3000K — 133 lm
4200K — 154 lm

Photometric diagrams

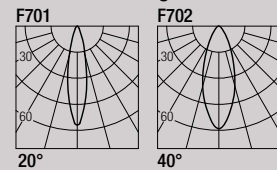

CRI85
2-Step MacAdam



JOS PT6

design: Roberto Mantovani

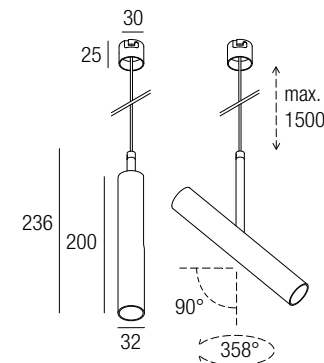

Supply current
Alimentazione
Courant d'alimentation
Stromversorgung
Corriente de alimentación
500 mA (V_i 9V)

Power
Potenza
Puissance
Bestuekung
Potencia
6 W

Series wiring
Cablaggio in serie
Câblage en série
Verkabelung in Serie
Cableado en serie



CCT/CRI/Flux

2700K — 540 lm
3000K — 600 lm
4000K — 620 lm

Photometric diagrams

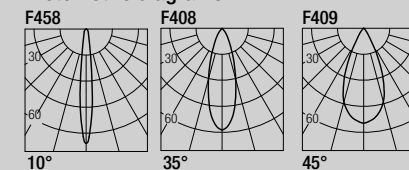

CRI98
2-Step MacAdam



Code Construction

Costruzione del codice - Construction du code produit
Bau der Produkt-Code - Construcción del código de producto

JSPT2 X X X

Beam angle
Apertura di fascio
Angle de faisceau
Strahlwinkel
Ángulo del haz

1 2
20° 40°

Color Temperature
Temperatura colore
Température couleur
Temperaturabhängige Farbe
Temperatura de color

2 3 4
2700K 3000K 4200K

Finishing
Finitura
Finitions
Oberflächenfinish
Acabados

1 5
White Black
Bianco Nero
Blanc Noir
Weiß Schwarz
Blanco Negro

Accessories

Accessori - Accessoires
Zubehör - Accesorios

ZQC001 ZQC001B

White Black
Bianco Nero
Blanc Noir
Weiß Schwarz
Blanco Negro

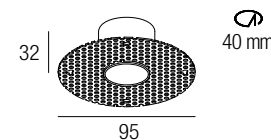

Plasterboard recessing frame
Flangia per cartongesso
Boîtier d'encastrement pour plaques de plâtre
Gehäuses Trockenbau
Cajetín para placas de yeso

Note: cable cut to measure on request
Nota: cavo a misura disponibile su richiesta
Note: câble sur mesure disponible sur demande
Anmerkung: kundenspezifisches Kabel auf Anfrage erhältlich
Nota: cable a medida disponible a petición

Drivers

Alimentatori - Alimentateurs
Netzteile - Alimentadores

on/off	dimnable
AL1074 (1..7) 30mm IP20	AL4010 (1..12) 72mm IP20 PUSH 0/1..10V
AL1077 (1..6) 40mm IP20	AL4151 (2..14) 72mm IP20 DALI 2
AL1084 (1..11) 55mm IP20 S.P.	AL4153 (1..14) 56mm IP20 PUSH IGBT-TRIAC

Code Construction

Costruzione del codice - Construction du code produit
Bau der Produkt-Code - Construcción del código de producto

JSPT6 X X X

Beam angle
Apertura di fascio
Angle de faisceau
Strahlwinkel
Ángulo del haz

0 1 2
10° 35° 45°

Color Temperature
Temperatura colore
Température couleur
Temperaturabhängige Farbe
Temperatura de color

2 3 4
2700K 3000K 4000K

Finishing
Finitura
Finitions
Oberflächenfinish
Acabados

1 5
White Black
Bianco Nero
Blanc Noir
Weiß Schwarz
Blanco Negro

Drivers

Alimentatori - Alimentateurs
Netzteile - Alimentadores

on/off	dimnable
AL1074 (1..2) 30mm IP20	AL4010 (1..4) 72mm IP20 PUSH 0/1..10V
AL1077 (1..2) 40mm IP20	AL4151 (1..4) 72mm IP20 DALI 2
AL1084 (1..3) 55mm IP20 S.P.	AL4153 (1..4) 56mm IP20 PUSH IGBT-TRIAC

Accessories

Accessori - Accessoires
Zubehör - Accesorios

ZQC001 ZQC001B

White Black
Bianco Nero
Blanc Noir
Weiß Schwarz
Blanco Negro

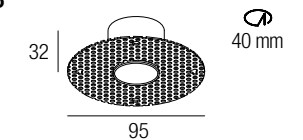

Plasterboard recessing frame
Flangia per cartongesso
Boîtier d'encastrement pour plaques de plâtre
Gehäuses Trockenbau
Cajetín para placas de yeso

LJ02 White Bianco Blanc Weiß Blanco	LJ02B Black Nero Noir Schwarz Negro	SJ02 White Bianco Blanc Weiß Blanco	SJ02B Black Nero Noir Schwarz Negro
Low luminance louver Filtro antiabbagliamento Filtre basse luminance Geringe Leuchtdichte-Filter Filtro de baja luminancia		Milky screen Schermo opale Ecran opale Opal-Bildschirm Pantalla opal	

Note: cable cut to measure on request
Nota: cavo a misura disponibile su richiesta
Note: câble sur mesure disponible sur demande
Anmerkung: kundenspezifisches Kabel auf Anfrage erhältlich
Nota: cable a medida disponible a petición

JOS PT10

design: Roberto Mantovani

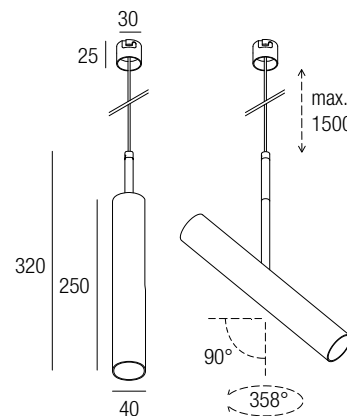

Supply current
 Alimentazione
 Courant d'alimentation
 Stromversorgung
 Corriente de alimentación
500 mA (V_I 18V)

Power
 Potenza
 Pouissance
 Bestuekung
 Potencia
10 W

Series wiring
 Cablaggio in serie
 Câblage en série
 Verkabelung in Serie
 Cableado en serie



Photometric diagrams

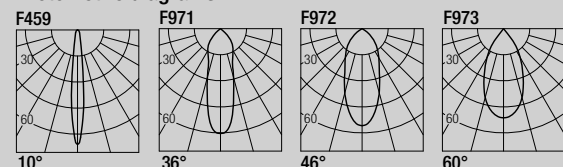

CCT/CRI/Flux

	CRI85	CRI93
2700K	890 lm	840 lm
3000K	1000 lm	930 lm
4000K	1040 lm	960 lm

CRI85 - CRI93
2-Step MacAdam



Code Construction

Costruzione del codice - Construction du code produit
 Bau der Produkt-Code - Construcción del código de producto

JSPT1 X X X X

Beam angle	N	S	M	W	X
Apertura di fascio Angle de faisceau Strahlwinkel Angulo del haz	10°	36°	46°	60°	10-55°
CRI	85	93			Adjustable optics Optica variabile Optique réglable Einstellbarer Optik Optica ajustable

Color Temperature	2	3	4
Temperatura colore Température couleur Temperaturabhängige Farbe Temperatura de color	2700K	3000K	4000K

Finishing	1	5
Finitura Finitions Oberflächenfinish Acabados	White Bianco Blanc Weiß Blanco	Black Nero Noir Schwarz Negro

Note: cable cut to measure on request
Nota: cavo a misura disponibile su richiesta
Note: câble sur mesure disponible sur demande
Anmerkung: kundenspezifisches Kabel auf Anfrage erhältlich
Nota: cable a medida disponible a petición

Accessories

Accessori - Accessoires
 Zubehör - Accesorios

ZQC001	ZQC001B
White Bianco Blanc Weiß Blanco	Black Nero Noir Schwarz Negro

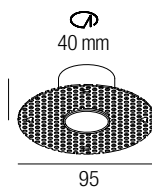

Plasterboard recessing frame
 Flangia per cartongesso
 Boîtier d'encastrement pour plaques de plâtre
 Gehäuses Trockenbau
 Cajetín para placas de yeso

LJ01	LJ01B
White Bianco Blanc Weiß Blanco	Black Nero Noir Schwarz Negro

Low luminance louver
 Filtro antiabbagliamento
 Filtre basse luminance
 Geringe Leuchtdichte-Filter
 Filtro de baja luminancia



SJ01	SJ01B
White Bianco Blanc Weiß Blanco	Black Nero Noir Schwarz Negro

Milky screen
 Schermo opale
 Écran opale
 Opal-Bildschirm
 Pantalla opal



Note: the filter and the screen are not available in 10-55° adjustable optics version - **Nota:** il filtro e lo schermo non sono disponibili nella versione ad ottica regolabile 10-55° - **Note:** le filtre et l'écran ne sont pas disponibles dans la version à optique réglable 10-55°
Anmerkung: Filter und Bildschirm sind in der einstellbaren optischen Version 10-55° nicht verfügbar - **Nota:** el filtro y la pantalla no están disponibles en la versión de óptica ajustable 10-55°

Drivers

Alimentatori - Alimentateurs
 Netzteile - Alimentadores

500 mA	on/off	dimmable
	AL1074 (1) 30mm IP20	AL4010 (1,2) 72mm IP20 PUSH 0/1..10V
	AL1077 (1) 40mm IP20	AL4151 (1,2) 72mm IP20 DALI 2
	AL1084 (1,2) 56mm IP20 S.P.	AL4153 (1,2) 56mm IP20 PUSH IGBT-TRIAC



GAGARIN PR2

design: Roberto Mantovani

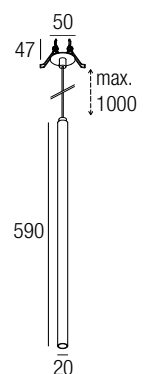

Supply current

Alimentazione
Courant d'alimentation
Stromversorgung
Corriente de alimentación

500 mA (V, 2,9V)

Power

Potenza
Puissance
Bestuekung
Potencia

2 W

Series wiring

Cablaggio in serie
Câblage en série
Verkabelung in Serie
Cableado en serie



CCT/CRI/Flux

2700K — 128 lm
3000K — 133 lm
4200K — 154 lm

Photometric diagrams

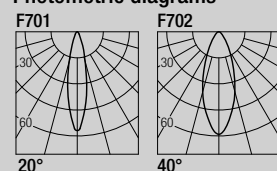

CRI85 - CRI93

2-Step MacAdam



Code Construction

Costruzione del codice - Construction du code produit
Bau der Produkt-Code - Construcción del código de producto

GPR2 X X X

Beam angle

Apertura di fascio
Angle de faisceau
Strahlwinkel
Ángulo del haz

1 2
20° 40°

Color Temperature

Temperatura colore
Température couleur
Temperaturabhängige Farbe
Temperatura de color

2 3 4
2700K 3000K 4200K

Finishing

Finitura
Finitions
Oberflächenfinish
Acabados

1 5
White Black
Bianco Nero
Blanc Noir
Weiß Schwarz
Blanco Negro

Drivers

Alimentatori - Alimentateurs
Netzteile - Alimentadores

on/off	dimmable
AL1074 (1..7) 30mm IP20	AL4010 (1..12) 72mm IP20 PUSH 0/1..10V
AL1077 (1..6) 40mm IP20	AL4151 (2..14) 72mm IP20 DALI 2
AL1084 (1..11) 55mm IP20 S.P.	AL4153 (1..14) 56mm IP20 PUSH IGBT-TRIAC

Note: cable cut to measure on request
Nota: cavo a misura disponibile su richiesta
Note: câble sur mesure disponible sur demande
Anmerkung: kundenspezifisches Kabel auf Anfrage erhältlich
Nota: cable a medida disponible a petición



GAGARIN PR6

design: Roberto Mantovani

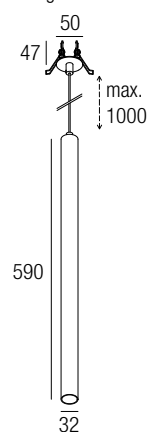
**Supply current**

Alimentazione
Courant d'alimentation
Stromversorgung
Corriente de alimentación

500 mA (V_I 9V)**Power**

Potenza
Puissance
Bestuekung
Potencia

6 W

Series wiring

Cablaggio in serie
Câblage en série
Verkabelung in Serie
Cableado en serie

**CCT/CRI/Flux**

2700K — 540 lm
3000K — 600 lm
4000K — 620 lm

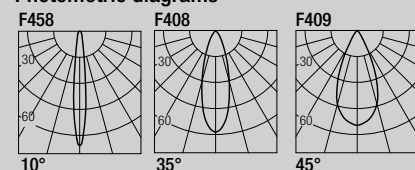
Photometric diagrams**CRI98**

2-Step MacAdam

Code Construction

Costruzione del codice - Construction du code produit
Bau der Produkt-Code - Construcción del código de producto

GPR6 X X X

Beam angle	0	1	2
Apertura di fascio Angle de faisceau Strahlwinkel Ángulo del haz	10°	35°	45°
Color Temperature	2	3	4
Temperatura colore Température couleur Temperaturabhängige Farbe Temperatura de color	2700K	3000K	4000K
Finishing	1	5	
Finitura Finitions Oberflächenfinish Acabados	White Bianco Blanc Weiß Blanco	Black Nero Noir Schwarz Negro	

Accessories

Accessori - Accessoires
Zubehör - Accesorios

LJ02	LJ02B	SJ02	SJ02B
White Bianco Blanc Weiß Blanco	Black Nero Noir Schwarz Negro	White Bianco Blanc Weiß Blanco	Black Nero Noir Schwarz Negro

Low luminance louver
Filtro antiabbagliamento
Filtre basse luminance
Geringe Leuchtdichte-Filter
Filtro de baja luminancia



Milky screen
Schermo opale
Écran opale
Opal-Bildschirm
Pantalla opal

**Drivers**

Alimentatori - Alimentateurs
Netzteile - Alimentadores

500 mA	on/off	dimmable
	AL1074 (1.2)	AL4010 (1.4)
	30mm IP20	72mm IP20 PUSH 0V1..10V
	AL1077 (1.2)	AL4151 (1.4)
	40mm IP20	72mm IP20 DALI 2
	AL1084 (1.3)	AL4153 (1.4)
	55mm IP20 S.P.	56mm IP20 PUSH IGBT-TRAC

Note: cable cut to measure on request

Nota: cavo a misura disponibile su richiesta

Note: câble sur mesure disponible sur demande

Anmerkung: kundenspezifisches Kabel auf Anfrage erhältlich

Nota: cable a medida disponible a petición



GAGARIN PR10

design: Roberto Mantovani

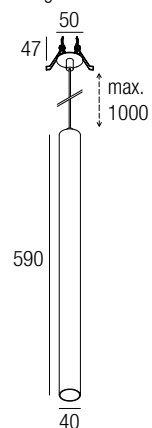
**Supply current**

Alimentazione
Courant d'alimentation
Stromversorgung
Corriente de alimentación

500 mA (V, 18V)

Power

Potenza
Puissance
Bestuekung
Potencia

10 W

Series wiring

Cablaggio in serie
Câblage en série
Verkabelung in Serie
Cableado en serie

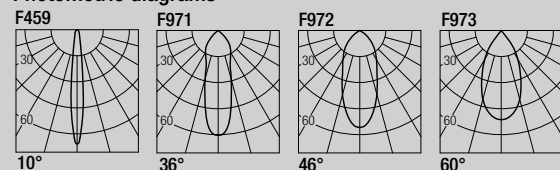
**Photometric diagrams****CCT/CRI/Flux**

	CRI85	CRI93
2700K	890 lm	840 lm
3000K	1000 lm	930 lm
4000K	1040 lm	960 lm

CRI85 - CRI93

2-Step MacAdam

**Code Construction**

Costruzione del codice - Construction du code produit
Bau der Produkt-Code - Construcción del código de producto

GPR1 X X X X

	N	S	M	W	X
Beam angle	10°	36°	46°	60°	10-55°
Apertura di fascio Angle de faisceau Strahlwinkel Ángulo del haz					Adjustable optics Optica variable Optique réglable Einstellbarer Optik Óptica ajustable
CRI	8	9			
	85	93			
Color Temperature	2	3	4		
Temperatura colore Température couleur Temperaturabhängige Farbe Temperatura de color	2700K	3000K	4000K		
Finishing	1	5			
Finitura Finitions Oberflächenfinish Acabados	White Bianco Blanc Weiß Blanco	Black Nero Noir Schwarz Negro			

Note: cable cut to measure on request**Nota:** cavo a misura disponibile su richiesta**Note:** câble sur mesure disponible sur demande**Anmerkung:** kundenspezifisches Kabel auf Anfrage erhältlich**Nota:** cable a medida disponible a petición**Accessories**

Accessori - Accessoires
Zubehör - Accesorios

LJ01

White
Bianco
Blanc
Weiß
Blanco

LJ01B

Black
Nero
Noir
Schwarz
Negro

SJ01

White
Bianco
Blanc
Weiß
Blanco

SJ01B

Black
Nero
Noir
Schwarz
Negro

Low luminance louver
Filtro antiabbagliamento
Filtre basse luminance
Geringe Leuchtdichte-Filter
Filtro de baja luminancia



Milky screen
Schermo opale
Écran opale
Opal-Bildschirm
Pantalla opal



Note: the filter and the screen are not available in 10-55° adjustable optics version - **Nota:** il filtro e lo schermo non sono disponibili nella versione ad ottica regolabile 10-55° - **Note:** le filtre et l'écran ne sont pas disponibles dans la version à optique réglable 10-55°

Anmerkung: Filter und Bildschirm sind in der einstellbaren optischen Version 10-55° nicht verfügbar - **Nota:** el filtro y la pantalla no están disponibles en la versión de óptica ajustable 10-55°

Drivers

Alimentatori - Alimentateurs
Netzteile - Alimentadores

500 mA	on/off	dimmable
AL1074 (1)	30mm IP20	AL4010 (1,2)
AL1077 (1)	40mm IP20	AL4151 (1,2)
AL1084 (1,2)	55mm IP20 S.P.	AL4153 (1,2)
		72mm IP20 PUSH 0/1..10V
		72mm IP20 DALI 2
		56mm IP20 PUSH IGBT-TRIAC



JOS PR2

design: Roberto Mantovani

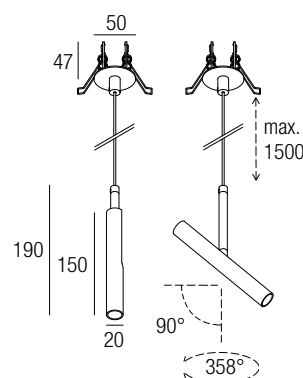
**Supply current**

Alimentazione
 Courant d'alimentation
 Stromversorgung
 Corriente de alimentación
500 mA (V_i 2,9V)

Power

Potenza
 Pouissance
 Bestuekung
 Potencia
2 W

Series wiring

Cablaggio in serie
 Câblage en série
 Verkabelung in Serie
 Cableado en serie

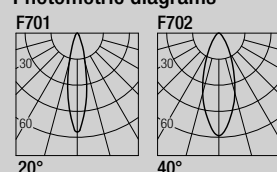
**Photometric diagrams****CCT/CRI/Flux**

2700K — 128 lm
 3000K — 133 lm
 4200K — 154 lm

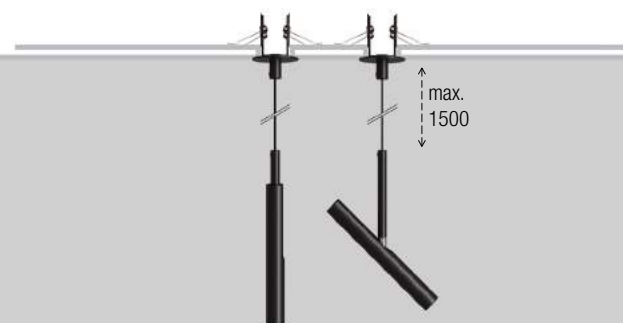
CRI85**2-Step MacAdam**

JOS PR6

design: Roberto Mantovani

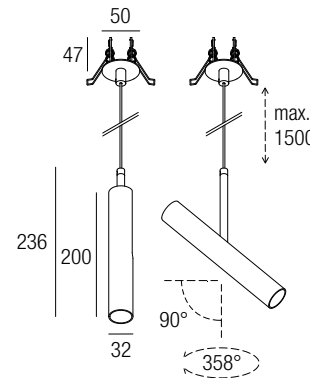
**Supply current**

Alimentazione
 Courant d'alimentation
 Stromversorgung
 Corriente de alimentación
500 mA (V_i 9V)

Power

Potenza
 Pouissance
 Bestuekung
 Potencia
6 W

Series wiring

Cablaggio in serie
 Câblage en série
 Verkabelung in Serie
 Cableado en serie

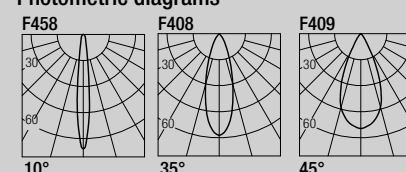
**Photometric diagrams****CCT/CRI/Flux**

2700K — 540 lm
 3000K — 600 lm
 4000K — 620 lm

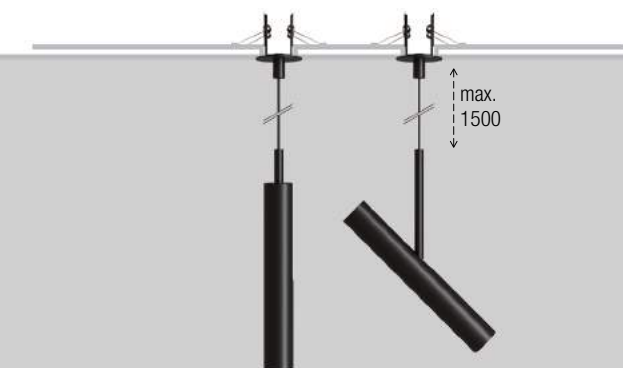
CRI98**2-Step MacAdam****Code Construction**

Costruzione del codice - Construction du code produit
 Bau der Produkt-Code - Construcción del código de producto

JSPR2 X X X

Beam angle Apertura di fascio Angle de faisceau Strahlwinkel Ángulo del haz	1 20°	2 40°	
Color Temperature Temperatura colore Température couleur Temperaturabhängige Farbe Temperatura de color	2 2700K	3 3000K	4 4200K
Finishing Finitura Finitions Oberflächenfinish Acabados	1 White Bianco Blanc Weiß Blanco	5 Black Nero Noir Schwarz Negro	

Drivers

Alimentatori - Alimentateurs
 Netzteile - Alimentadores

500 mA	on/off	dimmmable
AL1074 (1..7) 30mm IP20	AL4010 (1..12) 72mm IP20 PUSH 0/1..10V	
AL1077 (1..6) 40mm IP20	AL4151 (2..14) 72mm IP20 DALI 2	
AL1084 (1..11) 55mm IP20 S.P.	AL4153 (1..14) 56mm IP20 PUSH IGBT-TRIAC	

Note: cable cut to measure on request
Nota: cavo a misura disponibile su richiesta
Note: câble sur mesure disponible sur demande
Anmerkung: kundenspezifisches Kabel auf Anfrage erhältlich
Nota: cable a medida disponible a petición

Code Construction

Costruzione del codice - Construction du code produit
 Bau der Produkt-Code - Construcción del código de producto

JSPR6 X X X

Beam angle Apertura di fascio Angle de faisceau Strahlwinkel Ángulo del haz	0 10°	1 35°	2 45°
Color Temperature Temperatura colore Température couleur Temperaturabhängige Farbe Temperatura de color	2 2700K	3 3000K	4 4000K
Finishing Finitura Finitions Oberflächenfinish Acabados	1 White Bianco Blanc Weiß Blanco	5 Black Nero Noir Schwarz Negro	

Note: cable cut to measure on request
Nota: cavo a misura disponibile su richiesta
Note: câble sur mesure disponible sur demande
Anmerkung: kundenspezifisches Kabel auf Anfrage erhältlich
Nota: cable a medida disponible a petición

Accessories

Accessori - Accessoires
 Zubehör - Accesorios

LJ02 White Bianco Blanc Weiß Blanco	LJ02B Black Nero Noir Schwarz Negro	SJ02 White Bianco Blanc Weiß Blanco	SJ02B Black Nero Noir Schwarz Negro
Low luminance louver Filtro antiabbagliamento Filtre basse luminance Geringe Leuchtdichte-Filter Filtro de baja luminancia		Milky screen Schermo opale Écran opale Opal-Bildschirm Pantalla opal	

Drivers

Alimentatori - Alimentateurs
 Netzteile - Alimentadores

500 mA	on/off	dimmmable
AL1074 (1..2) 30mm IP20	AL4010 (1..4) 72mm IP20 PUSH 0/1..10V	
AL1077 (1..2) 40mm IP20	AL4151 (1..4) 72mm IP20 DALI 2	
AL1084 (1..3) 55mm IP20 S.P.	AL4153 (1..4) 56mm IP20 PUSH IGBT-TRIAC	

JOS PR10

design: Roberto Mantovani

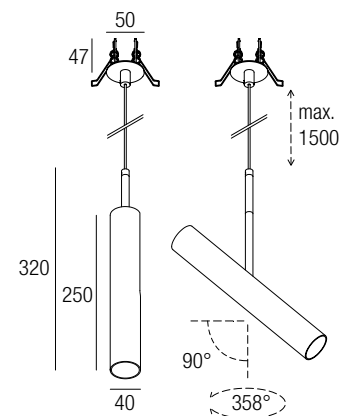

Supply current

Alimentazione
Courant d'alimentation
Stromversorgung
Corriente de alimentación
500 mA (V, 18V)

Power

Potenza
Puissance
Bestuekung
Potencia
10 W

Series wiring

Cablaggio in serie
Câblage en série
Verkabelung in Serie
Cableado en serie



Photometric diagrams

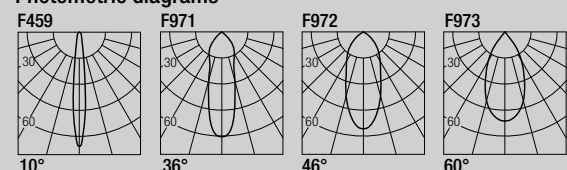

CCT/CRI/Flux

	CRI85	CRI93
2700K	890 lm	840 lm
3000K	1000 lm	930 lm
4000K	1040 lm	960 lm

CRI85 - CRI93

2-Step MacAdam



Code Construction

Costruzione del codice - Construction du code produit
Bau der Produkt-Code - Construcción del código de producto

JSPR1 X X X X

Beam angle	N	S	M	W	X
Apertura di fascio Angle de faisceau Strahlwinkel Ángulo del haz	10°	36°	46°	60°	10-55°
	Adjustable optics Óptica variable Optique réglable Einstellbarer Optik Óptica ajustable				
CRI	85	93			
Color Temperature	2700K	3000K	4000K		
Temperatura colore Température couleur Temperaturabhängige Farbe Temperatura de color					
Finishing	1	5			
Finitura Finitions Oberflächenfinish Acabados	White Bianco Blanc Weiß Blanco	Black Nero Noir Schwarz Negro			

Accessories

Accessori - Accessoires
Zubehör - Accesorios

LJ01	LJ01B	SJ01	SJ01B
White Bianco Blanc Weiß Blanco	Black Nero Noir Schwarz Negro	White Bianco Blanc Weiß Blanco	Black Nero Noir Schwarz Negro

Low luminance louver
Filtro antiabbagliamento
Filtre basse luminance
Geringe Leuchtdichte-Filter
Filtro de baja luminancia



Milky screen
Schermo opale
Écran opale
Opal-Bildschirm
Pantalla opal



Note: the filter and the screen are not available in 10-55° adjustable optics version - **Nota:** il filtro e lo schermo non sono disponibili nella versione ad ottica regolabile 10-55° - **Note:** le filtre et l'écran ne sont pas disponibles dans la version à optique réglable 10-55°

Anmerkung: Filter und Bildschirm sind in der einstellbaren optischen Version 10-55° nicht verfügbar - **Nota:** el filtro y la pantalla no están disponibles en la versión de óptica ajustable 10-55°

Drivers

Alimentatori - Alimentateurs
Netzteile - Alimentadores

500 mA	on/off	dimmable
AL1074 (1)	30mm IP20	AL4010 (1.2)
AL1077 (1)	40mm IP20	AL4151 (1.2)
AL1084 (1.2)	55mm IP20 S.P.	AL4153 (1.2)
AL9051 (1)	44mm IP67	AL8050 (1.2)
		IP67 DALI

Note: cable cut to measure on request
Nota: cavo a misura disponibile su richiesta
Note: câble sur mesure disponible sur demande
Anmerkung: kundenspezifisches Kabel auf Anfrage erhältlich
Nota: cable a medida disponible a petición



GAGARIN PS2

design: Roberto Mantovani

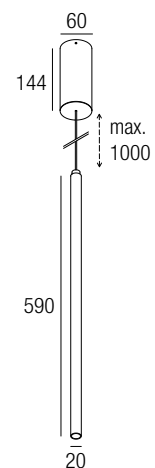

Supply current

Alimentazione
Courant d'alimentation
Stromversorgung
Corriente de alimentación

230 VAC

Power

Potenza
Pouissance
Bestuekung
Potencia

2 W



CCT/CRI/Flux

2700K — 128 lm
3000K — 133 lm
4200K — 154 lm

Photometric diagrams

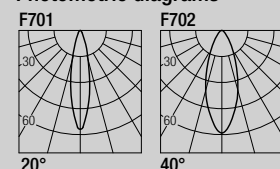

CRI85

2-Step MacAdam



Code Construction

Costruzione del codice - Construction du code produit
Bau der Produkt-Code - Construcción del código de producto

GPS2 X X X

Beam angle — 1 — 2
Apertura di fascio — 20° — 40°
Angle de faisceau
Strahlwinkel
Ángulo del haz

Color Temperature — 2 — 3 — 4
Temperatura colore — 2700K — 3000K — 4200K
Température couleur
Temperaturabhängige Farbe
Temperatura de color

Finishing — 1 — 5
Finitura — White — Black
Finitions — Bianco — Nero
Oberflächenfinish — Blanc — Noir
Acabados — Weiß — Schwarz
Blanco — Negro

Note: cable cut to measure on request
Nota: cavo a misura disponibile su richiesta
Note: câble sur mesure disponible sur demande
Anmerkung: kundenspezifisches Kabel auf Anfrage erhältlich
Nota: cable a medida disponible a petición



GAGARIN PS6

design: Roberto Mantovani

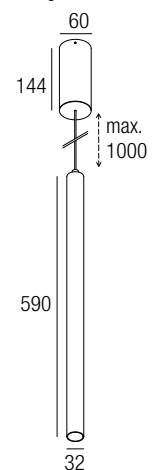

Supply current

Alimentazione
Courant d'alimentation
Stromversorgung
Corriente de alimentación

230 VAC

Power

Potenza
Puissance
Bestuekung
Potencia

6 W



CCT/CRI/Flux

2700K — 540 lm
3000K — 600 lm
4000K — 620 lm

Photometric diagrams

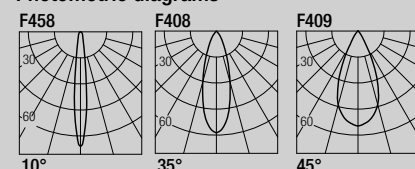

CRI98

2-Step MacAdam



Code Construction

Costruzione del codice - Construction du code produit
Bau der Produkt-Code - Construcción del código de producto

GPS6 X | X | X

Beam angle 0 1 2
Apertura di fascio 10° 35° 45°
Angle de faisceau
Strahlwinkel
Ángulo del haz

Color Temperature 2 3 4
Temperatura colore 2700K 3000K 4000K
Température couleur
Temperaturabhängige Farbe
Temperatura de color

Finishing 1 5
Finitura White Black
Finitions Bianco Nero
Oberflächenfinish Blanc Noir
Acabados Weiß Schwarz
Blanco Negro

Accessories

Accessori - Accessoires
Zubehör - Accesorios

LJ02 White Black
Bianco Nero
Blanc Noir
Weiß Schwarz
Blanco Negro

LJ02B White Black
Bianco Nero
Blanc Noir
Weiß Schwarz
Blanco Negro

Low luminance louver
Filtro antiabbagliamento
Filtre basse luminance
Geringe Leuchtdichte-Filter
Filtro de baja luminancia



Milky screen
Schermo opale
Écran opale
Opal-Bildschirm
Pantalla opal



Note: cable cut to measure on request
Nota: cavo a misura disponibile su richiesta
Note: câble sur mesure disponible sur demande
Anmerkung: kundenspezifisches Kabel auf Anfrage erhältlich
Nota: cable a medida disponible a petición



GAGARIN PS10

design: Roberto Mantovani

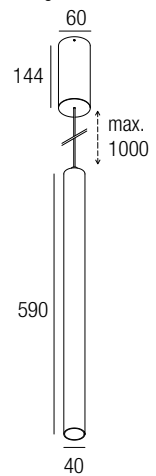

Supply current

Alimentazione
Courant d'alimentation
Stromversorgung
Corriente de alimentación

230 VAC

Power

Potenza
Puissance
Bestuekung
Potencia

10 W



Photometric diagrams

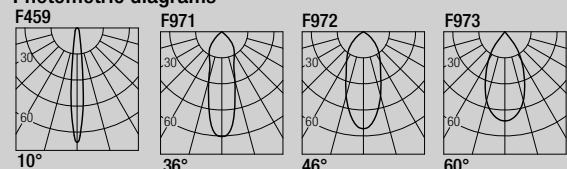

CCT/CRI/Flux

	CRI85	CRI93
2700K	890 lm	840 lm
3000K	1000 lm	930 lm
4000K	1040 lm	960 lm

CRI85 - CRI93

2-Step MacAdam



Code Construction

Costruzione del codice - Construction du code produit
Bau der Produkt-Code - Construcción del código de producto

GPS1 X X X X

	N	S	M	W	X
Beam angle	10°	36°	46°	60°	10-55°
Apertura di fascio Angle de faisceau Strahlwinkel Ángulo del haz					Adjustable optics Óptica variable Optique réglable Einstellbarer Optik Óptica ajustable
CRI	8	9			
	85	93			
Color Temperature	2	3	4		
Temperatura colore Température couleur Temperaturabhängige Farbe Temperatura de color	2700K	3000K	4000K		
Finishing	1	5			
Finitura Finitions Oberflächenfinish Acabados	White Bianco Blanc Weiß Blanco	Black Nero Noir Schwarz Negro			

Accessories

Accessori - Accessoires
Zubehör - Accesorios

LJ01	LJ01B	SJ01	SJ01B
White Bianco Blanc Weiß Blanco	Black Nero Noir Schwarz Negro	White Bianco Blanc Weiß Blanco	Black Nero Noir Schwarz Negro

Low luminance louver
Filtro antiabbagliamento
Filtre basse luminance
Geringe Leuchtdichte-Filter
Filtro de baja luminancia



Milky screen
Schermo opale
Écran opale
Opal-Bildschirm
Pantalla opal



Note: the filter and the screen are not available in 10-55° adjustable optics version - **Nota:** il filtro e lo schermo non sono disponibili nella versione ad ottica regolabile 10-55° - **Note:** le filtre et l'écran ne sont pas disponibles dans la version à optique réglable 10-55°

Anmerkung: Filter und Bildschirm sind in der einstellbaren optischen Version 10-55° nicht verfügbar - **Nota:** el filtro y la pantalla no están disponibles en la versión de óptica ajustable 10-55°

Note: cable cut to measure on request
Nota: cavo a misura disponibile su richiesta
Note: câble sur mesure disponible sur demande
Anmerkung: kundenspezifisches Kabel auf Anfrage erhältlich
Nota: cable a medida disponible a petición



JOS PS2

design: Roberto Mantovani

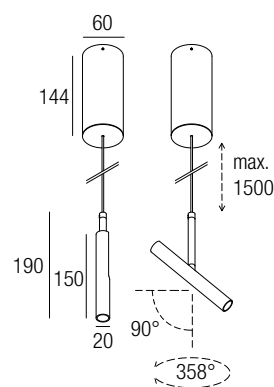

Supply current

Alimentazione
Courant d'alimentation
Stromversorgung
Corriente de alimentación

230 VAC

Power

Potenza
Puissance
Bestuekung
Potencia

2 W



Photometric diagrams

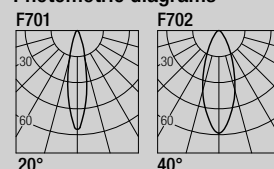

CCT/CRI/Flux

2700K — 128 lm
3000K — 133 lm
4200K — 154 lm

CRI85
2-Step MacAdam



JOS PS6

design: Roberto Mantovani

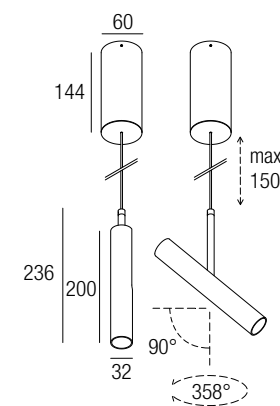

Supply current

Alimentazione
Courant d'alimentation
Stromversorgung
Corriente de alimentación

230 VAC

Power

Potenza
Puissance
Bestuekung
Potencia

6 W



Photometric diagrams

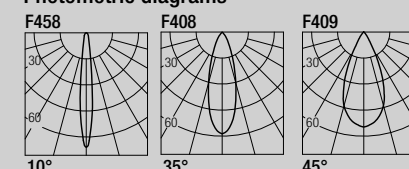

CCT/CRI/Flux

2700K — 540 lm
3000K — 600 lm
4000K — 620 lm

CRI98
2-Step MacAdam



Code Construction

Costruzione del codice - Construction du code produit
Bau der Produkt-Code - Construcción del código de producto

JSPS2 X X X

Beam angle	1	2	
Apertura di fascio	20°	40°	
Angle de faisceau			
Strahlwinkel			
Ángulo del haz			
Color Temperature	2	3	4
Temperatura colore	2700K	3000K	4200K
Température couleur			
Temperaturabhängige Farbe			
Temperatura de color			
Finishing	1	5	
Finitura	White	Black	
Finitions	Bianco	Nero	
Oberflächenfinish	Blanc	Noir	
Acabados	Weiß	Schwarz	
	Blanco	Negro	

Note: cable cut to measure on request

Nota: cavo a misura disponibile su richiesta

Note: câble sur mesure disponible sur demande

Anmerkung: kundenspezifisches Kabel auf Anfrage erhältlich

Nota: cable a medida disponible a petición

Code Construction

Costruzione del codice - Construction du code produit
Bau der Produkt-Code - Construcción del código de producto

JSPS6 X X X

Beam angle	0	1	2
Apertura di fascio	10°	35°	45°
Angle de faisceau			
Strahlwinkel			
Ángulo del haz			
Color Temperature	2	3	4
Temperatura colore	2700K	3000K	4000K
Température couleur			
Temperaturabhängige Farbe			
Temperatura de color			
Finishing	1	5	
Finitura	White	Black	
Finitions	Bianco	Nero	
Oberflächenfinish	Blanc	Noir	
Acabados	Weiß	Schwarz	
	Blanco	Negro	

Accessories

Accessori - Accessoires
Zubehör - Accesorios

LJ02	LJ02B	SJ02	SJ02B
White	Black	White	Black
Bianco	Nero	Bianco	Nero
Blanc	Noir	Blanc	Noir
Weiß	Schwarz	Weiß	Schwarz
Blanco	Negro	Blanco	Negro
Low luminance louver		Milky screen	
Filtro antiabbagliamento		Schermo opale	
Filtre basse luminance		Écran opale	
Geringe Leuchtdichte-Filter		Opal-Bildschirm	
Filtro de baja luminancia		Pantalla opal	

Note: cable cut to measure on request

Nota: cavo a misura disponibile su richiesta

Note: câble sur mesure disponible sur demande

Anmerkung: kundenspezifisches Kabel auf Anfrage erhältlich

Nota: cable a medida disponible a petición

JOS PS10

design: Roberto Mantovani

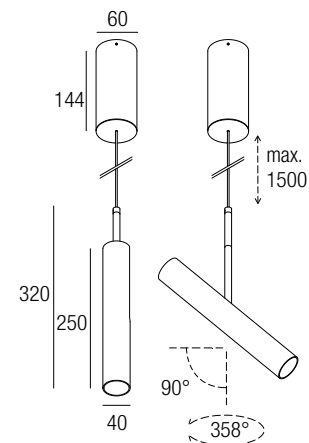

Supply current
 Alimentazione
 Courant d'alimentation
 Stromversorgung
 Corriente de alimentación
230 VAC

Power
 Potenza
 Puissance
 Bestuekung
 Potencia
10 W

IP20

Photometric diagrams

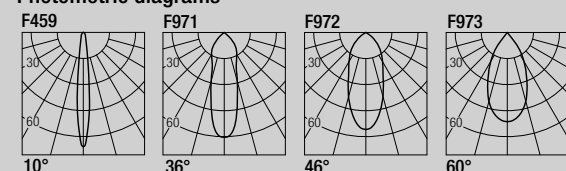

CCT/CRI/Flux

	CRI85	CRI93
2700K	890 lm	840 lm
3000K	1000 lm	930 lm
4000K	1040 lm	960 lm

CRI85 - CRI93
 2-Step MacAdam



Code Construction

Costruzione del codice - Construction du code produit
 Bau der Produkt-Code - Construcción del código de producto

JSPS1 X X X X

	N	S	M	W	X
Beam angle Apertura di fascio Angle de faisceau Strahlwinkel Angulo del haz	10°	36°	46°	60°	10-55° Adjustable optics Optica variabile Optique réglable Einstellbarer Optik Óptica ajustable
CRI	85	89	93		
Color Temperature Temperatura colore Température couleur Temperaturabhängige Farbe Temperatura de color	2700K	3000K	4000K		
Finishing Finitura Finitions Oberflächenfinish Acabados	1 White Bianco Blanc Weiß Blanco	5 Black Nero Noir Schwarz Negro			

Accessories

Accessori - Accessoires
 Zubehör - Accesorios

LJ01	LJ01B	SJ01	SJ01B
White Bianco Blanc Weiß Blanco	Black Nero Noir Schwarz Negro	White Bianco Blanc Weiß Blanco	Black Nero Noir Schwarz Negro

Low luminance louver
 Filtro antiabbagliamento
 Filtre basse luminance
 Geringe Leuchtdichte-Filter
 Filtro de baja luminancia

Milky screen
 Schermo opale
 Écran opale
 Opal-Bildschirm
 Pantalla opal

Note: the filter and the screen are not available in 10-55° adjustable optics version - **Nota:** il filtro e lo schermo non sono disponibili nella versione ad ottica regolabile 10-55° - **Note:** le filtre et l'écran ne sont pas disponibles dans la version à optique réglable 10-55°
Anmerkung: Filter und Bildschirm sind in der einstellbaren optischen Version 10-55° nicht verfügbar - **Nota:** el filtro y la pantalla no están disponibles en la versión de óptica ajustable 10-55°

Note: cable cut to measure on request
Nota: cavo a misura disponibile su richiesta
Note: câble sur mesure disponible sur demande
Anmerkung: kundenspezifisches Kabel auf Anfrage erhältlich
Nota: cable a medida disponible a petición





230VAC TRACK

Three-phase track system for surface or recessed installation. The electrified tracks are made of extruded aluminium alloy. The copper conductor cables are housed in high insulation resistance PVC extruded profiles. 230/250V - 16A mains power supply voltage and 380/440V industrial mains voltage. The system includes a wide range of accessories, linear, corner, tee, cross and flexible joints, allowing multiple tracks to be coupled.

Sistema di binario trifase per installazione superficiale o incassata. I binari elettrificati sono costruiti in lega di alluminio estruso. I cavi conduttori in rame sono alloggiati all'interno di profilati estrusi in PVC ad alta resistenza di isolamento. Alimentazione a tensione di rete 230/250V - 16A e a tensione di rete industriale 380/440V. Il sistema comprende un'ampia serie di accessori, giunti lineari, ad angolo, a T, a croce, flessibili, che permettono l'accoppiamento di più binari elettrificati.

Système de rail triphasé pour installation en surface ou encastrée. Les rails électrifiés sont construits en alliage d'aluminium extrudé. Les câbles conducteurs en cuivre sont logés à l'intérieur de profilés extrudés en PVC à haute résistance d'isolement. Alimentation à tension de réseau 230/250V - 16A et à tension de réseau industriel 380/440V. Le système comprend une large gamme d'accessoires, de joints linéaires, à angle, en T, à croix et flexibles qui permettent le couplage de plusieurs rails électrifiés.

Dreiphasiges Schienensystem zur oberflächlichen oder eingebauten Installation. Die Stromschienen werden aus Aluminiumextrusionsguss gefertigt. Die Kupferdrähte befinden sich in den extrudierten Aluminiumprofilen aus PVC mit hohem Isolationswiderstand. Speisung mit Netzspannung 230/250V - 16A und mit Industriennetzspannung 380/440V. Das System bietet zahlreiches Zubehör, lineare Verbindungsstücke, Winkelstücke, T- und Kreuz-Elemente und mehrere Stromschienen miteinander zu verbinden.

Sistema de carril trifásico para instalación superficial o empotrada. Los carriles electrificados están fabricados en aleación de aluminio extruido. Los cables conductores de cobre se alojan en el interior de los perfiles extruidos de PVC con alta resistencia de aislamiento. Alimentación con tensión de red 230/250V - 16A y con tensión de red industrial 380/440V. El sistema incluye una amplia serie de accesorios, juntas lineales, en ángulo, en T, en cruz, flexibles, que permiten el acoplamiento de más carriles electrificados.

230/250V (1) mains single-phase connection
Allows a total load of 16A, which corresponds to 3680/4000 watts divided onto 3 circuits.
230/400V three-phase mains connection (2)
Allows a total load of 16A, which corresponds to 11040 watts divided onto three circuits (3x3680 watts).

Collegamento a una rete monofase 230/250V (1)
Consente un carico complessivo di 16A, che corrisponde a 3680/4000 Watt suddivisibile su 3 circuiti.
Collegamento alla rete elettrica trifase 230/400V (2)
Consente un carico complessivo di 16A, che corrisponde a 11040 Watt ripartibili su tre circuiti (3x3680 Watt).

Connexion à un réseau triphasé 230/250V (1)
Permet une charge totale de 16A, ce qui correspond à 3680/4000 watts que l'on peut diviser sur 3 circuits.
Connexion au réseau électrique triphasé (2)
Permet une charge totale de 16A, ce qui correspond à 11040 watts que l'on peut diviser sur 3 circuits (3x3680 Watts).

Anschluss an ein einphasiges Netz 230/250V (1)
Lässt eine Gesamt-Ladung von 16A zu, entspricht 3680/4000 Watt, verteilbar auf 3 Kreisläufe.
Anschluss an ein dreiphasiges Stromnetz 230/400V (2)
Lässt eine Gesamt-Ladung von 16A zu, entspricht 11040 Watt, verteilbar auf 3 Kreisläufe (3x3680 Watt).

Conexión a una red monofásica 230/250V (1)
Permite una carga total de 16A, que corresponde a 3680/4000 W divisibles en 3 circuitos.
Conexión a la red eléctrica trifásica 230/400V (2)
Permite una carga total de 16A, que corresponde a 11040 W repartibles en 3 circuitos (3x3680 W).

For proper installation of all accessories that contribute forming a three-phase binary system, the continuity of the grounding line between each element is highly important. **In fact, the positioning of the ground conductors must be consequential between component and component.**

Per una corretta installazione di tutti gli accessori, che concorrono alla formazione di un impianto di binari trifase, ha grande importanza la continuità della linea di messa a terra tra ogni elemento. **Il posizionamento dei conduttori di terra, infatti, deve essere consequenziale tra componente e componente.**

Pour une installation correcte de tous les accessoires qui contribuent à la formation d'un système binaire triphasé, la continuité de la ligne de mise à la terre, entre chaque élément, a une grande importance. **Le positionnement des conducteurs de terre, en effet, doit être conséquent entre composant et composant.**

Zur korrekten Installation des Zubehörs, mit denen eine Anlage mit Dreiphasen-Schienen geformt wird, ist die Kontinuität der Erdung zwischen den einzelnen Elementen von wesentlicher Bedeutung. **Die Positionierung der Erdungsleiter, muss zwischen den einzelnen Komponenten fortlaufend sein.**

Para una correcta instalación de todos los accesorios que constituyen una instalación de carriles trifásicos, tiene una gran importancia la continuidad de la línea de puesta a tierra entre cada elemento. **El posicionamiento de los conductores de tierra, en efecto, debe ser consecuente entre componente y componente.**

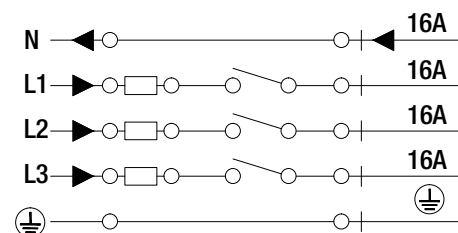
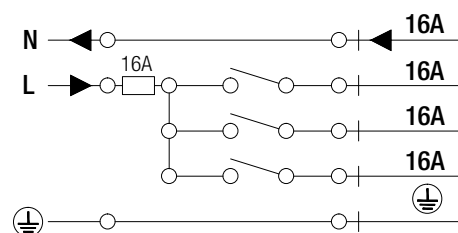

Track three-phase tracks can withstand a load of 2 kg per 200 mm, with a maximum distance between the fastening points of 1000 mm. In the case of a load of 5 Kg Every 200 mm, the fixing distance must be 500 mm.

I binari trifase Track possono sopportare un carico di 2 Kg. ogni 200 mm. con una distanza massima fra i punti di fissaggio di 1000 mm. Nel caso di carico di 5 Kg. Ogni 200 mm., la distanza di fissaggio deve essere di 500 mm.

Les voies triphasées Track peuvent supporter une charge de 2 kg tous les 200 mm., avec une distance maximale entre les points de fixation de 1000 mm. Dans le cas d'une charge de 5 kg., la distance de fixation doit être de 500 mm tous les 200 mm.

Die Track Dreiphasen-Schienen können alle 200 mm, eine Last bis zu 2 kg tragen, mit einem maximalen Abstand zwischen den Befestigungspunkten von 1000 mm. Bei Lasten von 5 kg, alle 200 mm, muss der Abstand der Befestigungen 500 mm betragen.

Los carriles trifásicos Track pueden soportar una carga de 2 Kg. cada 200 mm. con una distancia máxima entre los puntos de fijación de 1.000 mm. En caso de carga de 5 Kg. Cada 200 mm., la distancia de fijación debe ser de 500 mm.

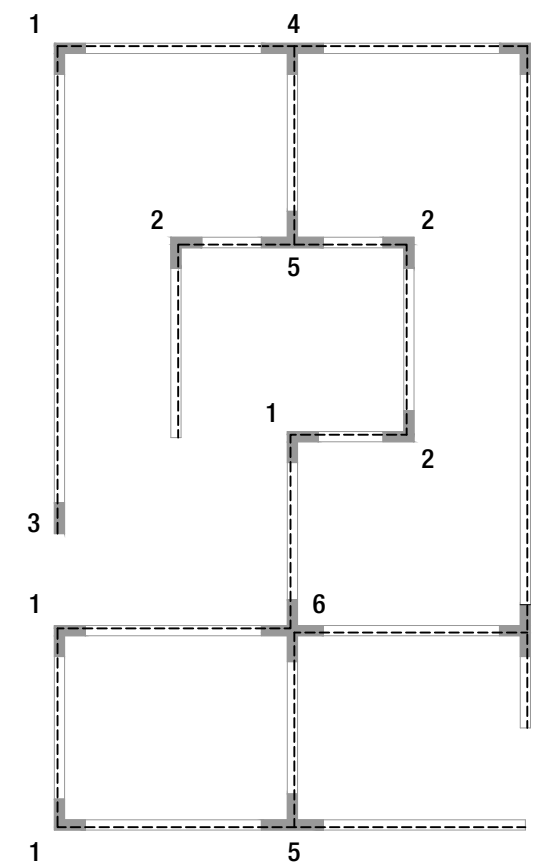

- 1 Outside L joint - Giunto L esterno
Joint L externe - L Gelenkaußen
Conjunta L externa
- 2 Inside L joint - Giunto L interno
Joint L interne - L Gelenkinnen
Conjunta L interna
- 3 Right live-end - Alimentazione destra
Alimentation droite - Macht rechts
Alimentación derecha
- 4 Right T joint - Giunto T destro
Joint T droite - Joint T rechts
Conjunta T derecha
- 5 Left T joint - Giunto T sinistro
Joint T gauche - Joint T links
Conjunta T izquierda
- 6 X joint - Giunto X
Joint X - Conjunta X

230VAC TRACK



Three-phase binary system for surface installation.

Sistema di binario trifase per installazione superficiale.

Système de voie triphasé pour installation en surface.

Dreiphasiges Schienensystem zur oberflächlichen Installation.

Sistema de carril trifásico para instalación superficial.

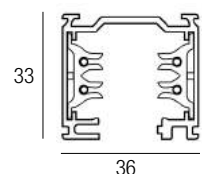

Code Construction

Costruzione del codice - Construction du code produit
Bau der Produkt-Code - Construcción del código de producto

TK11 X,X

Length	1	2	3
	1 mt	2 mt	3 mt

Finishing	1	2	5
	White Bianco Blanc Weiß Blanco	Grey Grigio Gris Grau	Black Nero Noir Schwarz Negro

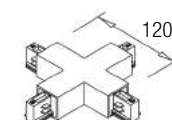

Giunto X
X joint
Joint X
Conjunta X



Giunto lineare con contatti
Electrical straight joint
Joint électrique
Elektrische Verbindung
Junta electrica

Giunto lineare senza contatti
Mechanical joint
Joint mécanique
Mechanische Verbindung
Junta mecánica

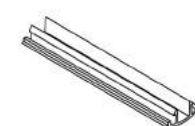

Copertura binario 1mt
Track cover 1mt
Ecran 1mt
Schirm 1mt
Pantalla 1mt

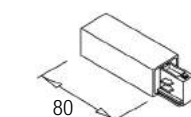

Testata di alimentazione destra
Right live-end
Tête d'alimentation droite
Macht rechts
Cabezal de alimentación derecha

- TK1102** Bianco - White - Blanc
Weiß - Blanco
- TK1202** Grigio - Grey
Gris - Grau
- TK1502** Nero - Black - Noir
Schwarz - Negro

Testata di alimentazione sinistra
Left live-end
Tête d'alimentation gauche
Macht links
Cabezal de alimentación izquierda

- TK1103** Bianco - White - Blanc
Weiß - Blanco
- TK1203** Grigio - Grey
Gris - Grau
- TK1503** Nero - Black - Noir
Schwarz - Negro

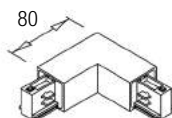

Giunto L interno
Inside L joint
Joint L interne
L Gelenkinnen
Conjunta L interna

- TK1104** Bianco - White - Blanc
Weiß - Blanco
- TK1204** Grigio - Grey
Gris - Grau
- TK1504** Nero - Black - Noir
Schwarz - Negro

Giunto L esterno
Outside L joint
Joint L externe
L Gelenkaußen
Conjunta L externa

- TK1105** Bianco - White - Blanc
Weiß - Blanco
- TK1205** Grigio - Grey
Gris - Grau
- TK1505** Nero - Black - Noir
Schwarz - Negro

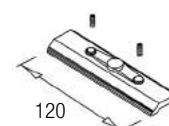

Piattina 120mm
Plate 120 mm
Plaque 120mm
Platte 120mm
Placa 120mm

TK1010

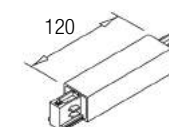

Alimentazione centrale e giunto lineare
Central connector and straight joint
Connecteur central et joint électrique
Zentralstecker und elektrische Verbindung
Connector central y junta electrica

- TK5112** Bianco - White - Blanc
Weiß - Blanco
- TK5212** Grigio - Grey
Gris - Grau
- TK5512** Nero - Black - Noir
Schwarz - Negro

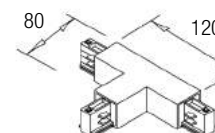

Giunto T destro
Right T joint
Joint T droite
Joint T rechts
Conjunta T derecha

- TK5113** Bianco - White - Blanc
Weiß - Blanco
- TK5213** Grigio - Grey
Gris - Grau
- TK5513** Nero - Black - Noir
Schwarz - Negro

Giunto T sinistro
Left T joint
Joint T gauche
Joint T links
Conjunta T izquierda

- TK5114** Bianco - White - Blanc
Weiß - Blanco
- TK5214** Grigio - Grey
Gris - Grau
- TK5514** Nero - Black - Noir
Schwarz - Negro

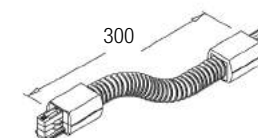

Giunto flessibile
Flexible joint
Joint flexible
Flexible Verbindung
Junta flexible

- TK1115** Bianco - White - Blanc
Weiß - Blanco
- TK1215** Grigio - Grey
Gris - Grau
- TK1515** Nero - Black - Noir
Schwarz - Negro



Chiusura
Dead end
Bouchon
Endkappe
Tapa

- TK1116** Bianco - White - Blanc
Weiß - Blanco
- TK1216** Grigio - Grey
Gris - Grau
- TK1516** Nero - Black - Noir
Schwarz - Negro



Kit attacco soffitto
Ceiling kit
Kit de plafond
Decken Kit
Kit de techo

TK1017



Sospensione Kit cavo acciaio 2mt
Suspension kit with steel wire 2mt
Kit de suspension avec du fil d'acier de 2mt
Fahrwerk mit Stahldraht 2mt
Kit de suspension con alambre de acero 2mt

- TK1118** Bianco - White - Blanc
Weiß - Blanco
- TK1518** Nero - Black - Noir
Schwarz - Negro



Sospensione Kit tige 1mt
Suspension kit with pipe 1mt
Kit de suspension avec tige 1mt
Fahrwerk mit Rohr 1mt
Kit de suspension con tige de 1mt

TK1019

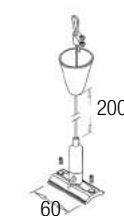

Sospensione Kit cavo acciaio 2mt + bloccacavo automatico
Suspension kit with 2mt steel wire and automatic locking device
Kit de suspension à 2mt fil d'acier et un dispositif de verrouillage automatique
Fahrwerk mit 2mt Stahldraht und automatischer Verriegelung
Kit de suspension con 2mt alambre de acero y el dispositivo de bloqueo automático

- TK1120** Bianco - White - Blanc
Weiß - Blanco
- TK1520** Nero - Black - Noir
Schwarz - Negro

BULL 10

design: Lapo Grassellini

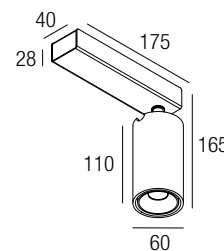

Supply current

Alimentazione
Courant d'alimentation
Stromversorgung
Corriente de alimentación

230 VAC

Power

Potenza
Puissance
Bestuekung
Potencia

10 W

IP20

Photometric diagrams

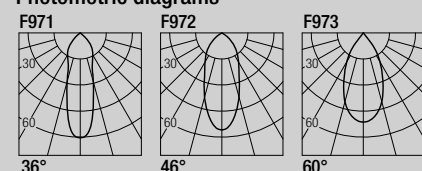

CCT/CRI/Flux

	CRI85	CRI93
2700K	890 lm	840 lm
3000K	1000 lm	930 lm
4000K	1040 lm	960 lm

CRI85 - CRI93
2-Step MacAdam

Code Construction

Costruzione del codice - Construction du code produit
Bau der Produkt-Code - Construcción del código de producto

BU1 X X X X X

Beam angle S M W
Apertura di fascio 36° 46° 60°
Angle de faisceau
Strahlwinkel
Ángulo del haz

CRI 8 9
85 93

Color Temperature 2 3 4
Temperatura colore 2700K 3000K 4000K
Température couleur
Temperaturabhängige Farbe
Temperatura de color

Body color 1 2 5
Finitura del corpo White Grey Black
Couleur du corps Bianco Grigio Nero
Körperfarbe Blanc Gris Noir
Color del cuerpo Weiß Grau Schwarz
Blanco Negro

Color of the cylinder 1 2 5
Finitura cilindro White Grey Black
Couleur du cylindre Bianco Grigio Nero
Farbe der Zylinder Blanc Gris Noir
Color del cilindro Weiß Grau Schwarz
Blanco Negro

Accessories

Accessori - Accessoires
Zubehör - Accesorios

BUX1NA

Low luminance louver
Filtro antiabbagliamento
Filtre basse luminance
Geringe Leuchtdichte-Filter
Filtro de baja luminancia



SBU101

Milky screen
Schermo opale
Écran opale
Opal-Bildschirm
Pantalla opal



Note: the screen must be ordered together with the lighting fixture - **Nota:** lo schermo deve essere ordinato congiuntamente all'apparecchio - **Note:** l'écran doit être commandé en même temps que l'appareil
Anmerkung: muss der Bildschirm zusammen mit Leuchtkörper bestellt werden - **Nota:** la pantalla debe pedirse junta con la luminaria

BUX1FL

Adjustable barn door flaps
Alette paraluce orientabili
Volets orientables anti-éblouissement
Verstellbare Blenden
Aletas direccionales

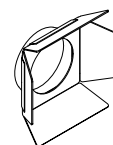

Note: dimmable version available on request
Nota: versioni dimmerabili disponibili su richiesta
Note: version dimmable disponible sur demande
Anmerkung: dimmbare Version auf Anfrage
Nota: versiones regulables disponibles bajo petición



BULL 20

design: Lapo Grassellini

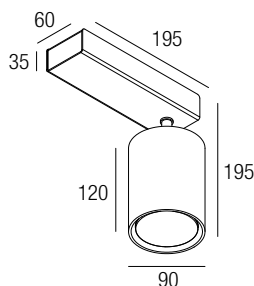

Supply current

Alimentazione
Courant d'alimentation
Stromversorgung
Corriente de alimentación

230 VAC

Power

Potenza
Puissance
Bestuekung
Potencia

20 W

IP20

Photometric diagrams

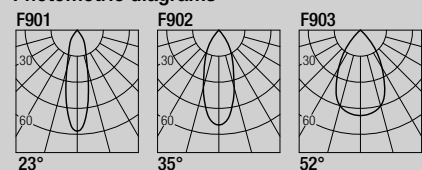

CCT/CRI/Flux

	CRI85	CRI93
2700K	1830 lm	1700 lm
3000K	2000 lm	1830 lm
4000K	2100 lm	1950 lm

CRI85 - CRI93
2-Step MacAdam



Code Construction

Costruzione del codice - Construction du code produit
Bau der Produkt-Code - Construcción del código de producto

BU2 X X X X X

Beam angle	S	M	W
Apertura di fascio Angle de faisceau Strahlwinkel Ángulo del haz	23°	35°	52°

CRI	8	9
	85	93

Color Temperature	2	3	4
Temperatura colore Température couleur Temperaturabhängige Farbe Temperatura de color	2700K	3000K	4000K

Body color	1	2	5
Finitura del corpo Couleur du corps Körperfarbe Color del cuerpo	White Bianco Blanc Weiß Blanco	Grey Grigio Gris Grau	Black Nero Noir Schwarz Negro

Color of the cylinder	1	2	5
Finitura cilindro Couleur du cylindre Farbe der Zylinder Color del cilindro	White Bianco Blanc Weiß Blanco	Grey Grigio Gris Grau	Black Nero Noir Schwarz Negro

Accessories

Accessori - Accessoires
Zubehör - Accesorios

BUX2NA

Low luminance louver
Filtro antiabbagliamento
Filtre basse luminance
Geringe Leuchtdichte-Filter
Filtro de baja luminancia



BUX2FL

Adjustable barn door flaps
Alette paraluze orientabili
Volets orientables anti-éblouissement
Verstellbare Blenden
Aletas direccionales

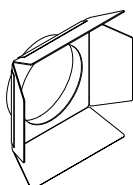

Note: dimmable version available on request

Nota: versioni dimmerabili disponibili su richiesta

Note: version dimmable disponible sur demande

Anmerkung: dimmbare Version auf Anfrage

Nota: versiones regulables disponibles bajo petición



BULL 40

design: Lapo Grassellini

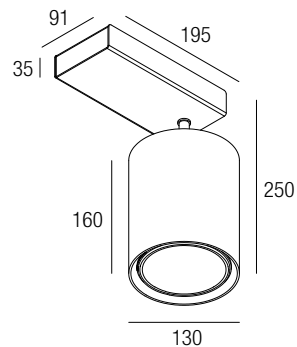

Supply current
 Alimentazione
 Courant d'alimentation
 Stromversorgung
 Corriente de alimentación
230 VAC

Power
 Potenza
 Pouissance
 Bestuekung
 Potencia
40 W

IP20

Photometric diagrams

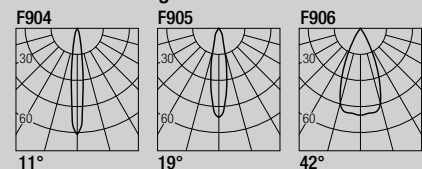

CCT/CRI/Flux	CRI85	CRI93
2700K	3660 lm	3400 lm
3000K	4000 lm	3660 lm
4000K	4200 lm	3900 lm

CRI85 - CRI93
 2-Step MacAdam



Code Construction

Costruzione del codice - Construction du code produit
 Bau der Produkt-Code - Construcción del código de producto

BU4 X X X X X

Beam angle	S	M	W
Apertura di fascio Angle de faisceau Strahlwinkel Ángulo del haz	11°	19°	42°

CRI	8	9
	85	93

Color Temperature	2	3	4
Temperatura colore Température couleur Temperaturabhängige Farbe Temperatura de color	2700K	3000K	4000K

Body color	1	2	5
Finitura del corpo Couleur du corps Körperfarbe Color del cuerpo	White Bianco Blanc Weiß Blanco	Grey Grigio Gris Grau	Black Nero Noir Schwarz Negro

Color of the cylinder	1	2	5
Finitura cilindro Couleur du cylindre Farbe der Zylinder Color del cilindro	White Bianco Blanc Weiß Blanco	Grey Grigio Gris Grau	Black Nero Noir Schwarz Negro

Accessories

Accessori - Accessoires
 Zubehör - Accesorios

BUX4NA

Low luminance louver
 Filtro antiabbagliamento
 Filtre basse luminance
 Geringe Leuchtdichte-Filter
 Filtro de baja luminancia



BUX4FL

Adjustable barn door flaps
 Alette paraluze orientabili
 Volets orientables anti-éblouissement
 Verstellbare Blenden
 Aletas direccionales

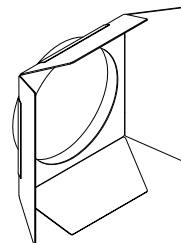

Note: dimmable version available on request
Nota: versioni dimmerabili disponibili su richiesta
Note: version dimmable disponible sur demande
Anmerkung: dimmbare Version auf Anfrage
Nota: versiones regulables disponibles bajo petición



BULL 10 PRECISION

design: Lapo Grassellini

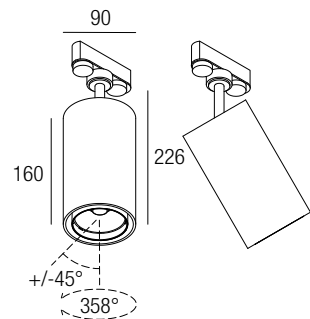

Supply current

Alimentazione
 Courant d'alimentation
 Stromversorgung
 Corriente de alimentación
230 VAC

Power

Potenza
 Pouissance
 Bestuekung
 Potencia
10 W



Photometric diagrams

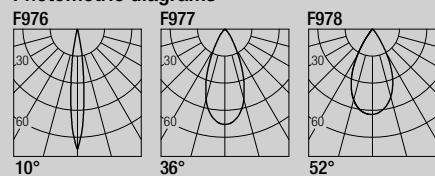

CCT/CRI/Flux

	CRI85	CRI93
2700K	890 lm	840 lm
3000K	1000 lm	930 lm
4000K	1040 lm	960 lm

CRI85 - CRI93
2-Step MacAdam

Code Construction

Costruzione del codice - Construction du code produit
 Bau der Produkt-Code - Construcción del código de producto

BP1 X X X X

Beam angle	S	M	W
Apertura di fascio Angle de faisceau Strahlwinkel Ángulo del haz	10°	36°	52°

CRI	8	9
	85	93

Color Temperature	2	3	4
Temperatura colore Température couleur Temperaturabhängige Farbe Temperatura de color	2700K	3000K	4000K

Finishing	1	2	5
Finitura Finitions Oberflächenfinish Acabados	White Bianco Weiß Blanco	Grey Grigio Gris Grau	Black Nero Noir Schwarz Negro

Accessories

Accessori - Accessoires
 Zubehör - Accesorios

BUX2NA

Low luminance louver
 Filtro antiabbagliamento
 Filtre basse luminance
 Geringe Leuchtdichte-Filter
 Filtro de baja luminancia



BUX2FL

Adjustable barn door flaps
 Alette paraluze orientabili
 Volets orientables anti-éblouissement
 Verstellbare Blenden
 Aletas direccionales

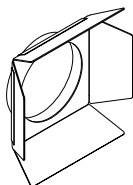

Note: dimmable version available on request
Nota: versioni dimmerabili disponibili su richiesta
Note: version dimmable disponible sur demande
Anmerkung: dimmbare Version auf Anfrage
Nota: versiones regulables disponibles bajo petición



BULL 20 PRECISION

design: Lapo Grassellini

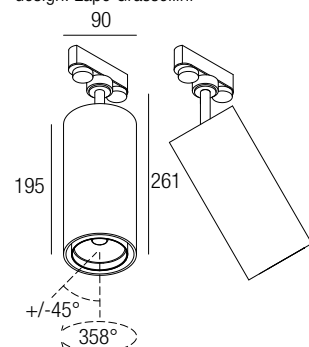

Supply current
 Alimentazione
 Courant d'alimentation
 Stromversorgung
 Corriente de alimentación
230 VAC

Power
 Potenza
 Pouissance
 Bestuekung
 Potencia
20 W

IP20

Photometric diagrams

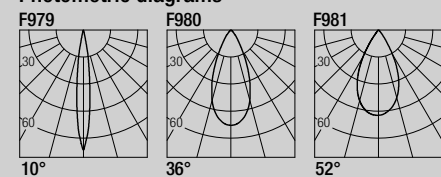

CCT/CRI/Flux

	CRI85	CRI93
2700K	1830 lm	1700 lm
3000K	2000 lm	1830 lm
4000K	2100 lm	1950 lm

CRI85 - CRI93
 2-Step MacAdam



Code Construction

Costruzione del codice - Construction du code produit
 Bau der Produkt-Code - Construcción del código de producto

BP2 X X X X

Beam angle — **S** — **M** — **W**
 Apertura di fascio 10° 36° 52°
 Angle de faisceau
 Strahlwinkel
 Ángulo del haz

CRI — **8** — **9**
 85 93

Color Temperature — **2** — **3** — **4**
 Temperatura colore 2700K 3000K 4000K
 Température couleur
 Temperaturabhängige Farbe
 Temperatura de color

Finishing — **1** — **2** — **5**
 Finitura White Grey Black
 Finitions Bianco Grigio Nero
 Oberflächenfinish Blanc Gris Noir
 Acabados Weiß Grau Schwarz
 Blanco Negro

Accessories

Accessori - Accessoires
 Zubehör - Accesorios

BUX2NA

Low luminance louver
 Filtro antiabbagliamento
 Filtre basse luminance
 Geringe Leuchtdichte-Filter
 Filtro de baja luminancia



BUX2FL

Adjustable barn door flaps
 Alette paraluze orientabili
 Volets orientables anti-éblouissement
 Verstellbare Blenden
 Aletas direccionales

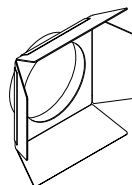

Note: dimmable version available on request
Nota: versioni dimmerabili disponibili su richiesta
Note: version dimmable disponible sur demande
Anmerkung: dimmbare Version auf Anfrage
Nota: versiones regulables disponibles bajo petición



BULL 10 FOCUS

design: Lapo Grassellini

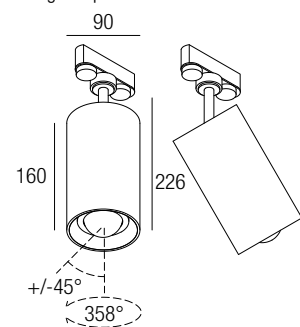

Supply current

Alimentazione
 Courant d'alimentation
 Stromversorgung
 Corriente de alimentación

230 VAC

Power

Potenza
 Pouissance
 Bestuekung
 Potencia

10 W



IP20

CCT/CRI/Flux

	CRI85	CRI93
2700K	890 lm	840 lm
3000K	1000 lm	930 lm
4000K	1040 lm	960 lm

CRI85 - CRI93

2-Step MacAdam

Adjustable optics

Ottica variabile
 Optique réglable
 Einstellbarer Optik
 Óptica ajustable

10-55°



Code Construction

Costruzione del codice - Construction du code produit
 Bau der Produkt-Code - Construcción del código de producto

BF1 X X X

CRI	8	9	
	85	93	
Color Temperature	2	3	4
Temperatura colore Température couleur Temperaturabhängige Farbe Temperatura de color	2700K	3000K	4000K
Finishing	1	2	5
Finitura Finitions Oberflächenfinish Acabados	White Bianco Blanc Weiß Blanco	Grey Grigio Gris Grau	Black Nero Noir Schwarz Negro

Accessories

Accessori - Accessoires
 Zubehör - Accesorios

BUX2FL

Adjustable barn door flaps
 Alette paraluze orientabili
 Volets orientables anti-éblouissement
 Verstellbare Blenden
 Aletas direccionales

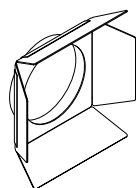

Note: dimmable version available on request

Nota: versioni dimmerabili disponibili su richiesta

Note: version dimmable disponible sur demande

Anmerkung: dimmbare Version auf Anfrage

Nota: versiones regulables disponibles bajo petición



BULL 20 FOCUS

design: Lapo Grassellini

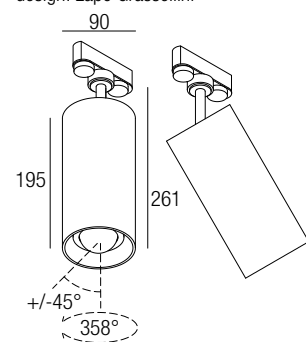

Supply current

Alimentazione
Courant d'alimentation
Stromversorgung
Corriente de alimentación

230 VAC

Power

Potenza
Puissance
Bestuekung
Potencia

20 W



IP20

CCT/CRI/Flux

	CRI85	CRI93
2700K	1830 lm	1700 lm
3000K	2000 lm	1830 lm
4000K	2100 lm	1950 lm

CRI85 - CRI93

2-Step MacAdam

Adjustable optics

Ottica variabile
Optique réglable
Einstellbarer Optik
Óptica ajustable

10-55°



Code Construction

Costruzione del codice - Construction du code produit
Bau der Produkt-Code - Construcción del código de producto

BF2 X X X

CRI

8	9
85	93

Color

Temperature

2	3	4
2700K	3000K	4000K

Temperatura colore
Température couleur
Temperaturabhängige Farbe
Temperatura de color

Finishing

1	2	5
---	---	---

White	Grey	Black
Bianco	Grigio	Nero
Blanc	Gris	Noir
Weiß	Grau	Schwarz
Blanco	Negro	

Accessories

Accessori - Accessoires
Zubehör - Accesorios

BUX2NA

Low luminance louver
Filtro antiabbagliamento
Filtre basse luminance
Geringe Leuchtdichte-Filter
Filtro de baja luminancia



BUX2FL

Adjustable barn door flaps
Alette paraluze orientabili
Volets orientables anti-éblouissement
Verstellbare Blenden
Aletas direccionales

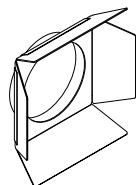

Note: dimmable version available on request

Nota: versioni dimmerabili disponibili su richiesta

Note: version dimmable disponible sur demande

Anmerkung: dimmbare Version auf Anfrage

Nota: versiones regulables disponibles bajo petición



ABRAHM 1020

design: Lapo Grassellini

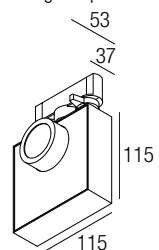

Supply current

Alimentazione
Courant d'alimentation
Stromversorgung
Corriente de alimentación

230 VAC

Power

Potenza
Pouissance
Bestuekung
Potencia

10 W - 20 W



Photometric diagrams

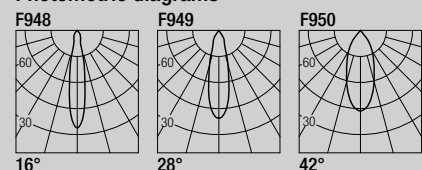

CCT/CRI/Flux

	CRI85	CRI93	
2700K	890 lm	840 lm	10W
3000K	1590 lm	1280 lm	20W
4000K	1000 lm	930 lm	10W
	1710 lm	1380 lm	20W
	1040 lm	960 lm	10W
	1965 lm	1485 lm	20W

CRI85 - CRI93

2-Step MacAdam



Code Construction

Costruzione del codice - Construction du code produit
Bau der Produkt-Code - Construcción del código de producto

AB X X X X X X

Beam angle	S	M	W
Apertura di fascio Angle de faisceau Strahlwinkel Ángulo del haz	16°	28°	42°

CRI	8	9
	85	93

Color Temperature	2	3	4
Temperatura colore Température couleur Temperaturabhängige Farbe Temperatura de color	2700K	3000K	4000K

Front color	1	2	5
Finitura frontale Couleur du frontale Frontscheibe Color de la pantalla	White Bianco Blanc Weiß Blanco	Grey Grigio Gris Grau	Black Nero Noir Schwarz Negro

Body color	1	2	5
Finitura del corpo Couleur du corps Körperfarbe Color del cuerpo	White Bianco Blanc Weiß Blanco	Grey Grigio Gris Grau	Black Nero Noir Schwarz Negro

Power	1	2
Potenza Pouissance Bestuekung Potencia	10 W	20 W



ABRAHM 3040

design: Lapo Grassellini

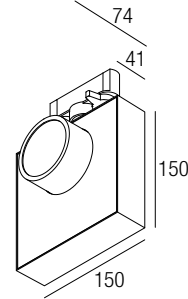

Supply current

Alimentazione
Courant d'alimentation
Stromversorgung
Corriente de alimentación

230 VAC

Power

Potenza
Pouissance
Bestuekung
Potencia

30W - 40W



Photometric diagrams

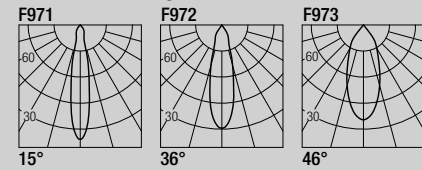

CCT/CRI/Flux

	CRI85	CRI93	
2700K	2530 lm	1920 lm	30W
3000K	3120 lm	2400 lm	40W
4000K	2700 lm	2060 lm	30W
	3400 lm	2580 lm	40W
	2820 lm	2150 lm	30W
	3460 lm	2760 lm	40W

CRI85 - CRI93
2-Step MacAdam



Code Construction

Costruzione del codice - Construction du code produit
Bau der Produkt-Code - Construcción del código de producto

AB X X X X X X

Beam angle	S	M	W
Apertura di fascio	15°	36°	46°
Angle de faisceau			
Strahlwinkel			
Ángulo del haz			

CRI	8	9
	85	93

Color Temperature	2	3	4
Temperatura colore	2700K	3000K	4000K
Température couleur			
Temperaturabhängige Farbe			
Temperatura de color			

Front color	1	2	5
Finitura frontale	White	Grey	Black
Couleur du frontale	Bianco	Grigio	Nero
Frontscheibe	Blanc	Gris	Noir
Color de la pantalla	Weiß	Grau	Schwarz
	Blanco		Negro

Body color	1	2	5
Finitura del corpo	White	Grey	Black
Couleur du corps	Bianco	Grigio	Nero
Körperfarbe	Blanc	Gris	Noir
Color del cuerpo	Weiß	Grau	Schwarz
	Blanco		Negro

Power	3	4
Potenza	30 W	40 W
Pouissance		
Bestuekung		
Potencia		



24VDC TRACK



24VDC track system for surface installation.

Sistema di binario 24VDC per installazione superficiale.

Système de voie 24VDC pour installation en surface.

24VDC Schienensystem für Anbaumontage.

Sistema de carril 24VDC para instalación en superficie.

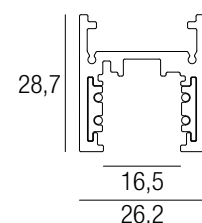

Code Construction

Costruzione del codice - Construction du code produit
Bau der Produkt-Code - Construcción del código de producto

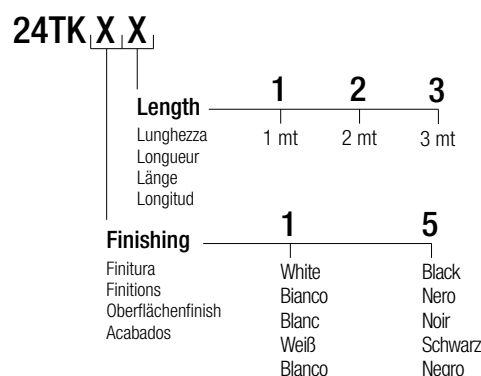

Load schemes - Schemi di carico

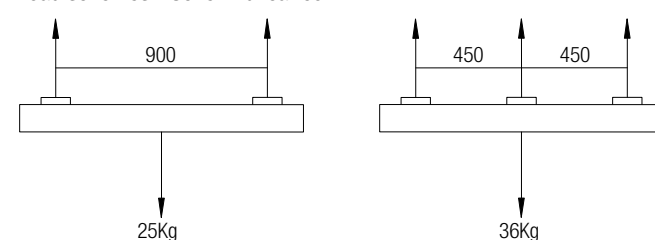

Drivers

Alimentatori - Alimentateurs
Netzteile - Alimentadores

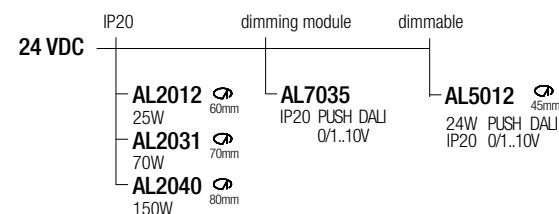

Note: dimming module AL7035 to be used in combination with a 24VDC power supply - **Nota:** modulo di dimmerazione AL7035 da utilizzare in combinazione con un alimentatore 24VDC - **Note:** module de variation AL7035 d'intensité à utiliser en combinaison avec une alimentation 24VDC - **Anmerkung:** Dimmmodul AL7035 zur Verwendung in Kombination mit einem 24VDC-Netzteil - **Nota:** módulo de regulación AL7035 se utiliza en combinación con una fuente de alimentación 24VDC

Accessories - Accessori

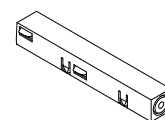

Testata di alimentazione
Live-end
Tête d'alimentation
Macht
Cabezal de alimentación

24TK011 Bianco - White - Blanc
Weiß - Blanco

24TK015 Nero - Black - Noir
Schwarz - Negro

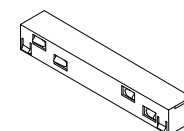

Giunto lineare con contatti
Electrical straight joint
Joint électrique
Elektrische Verbindung
Junta electrica

24TK021 Bianco - White - Blanc
Weiß - Blanco

24TK025 Nero - Black - Noir
Schwarz - Negro

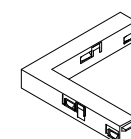

Giunto L elettrico
Electrical L joint
Joint L électrique
Elektrisches L-Verbindung
Junta L eléctrica

24TK031 Bianco - White - Blanc
Weiß - Blanco

24TK035 Nero - Black - Noir
Schwarz - Negro

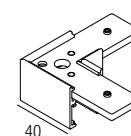

Giunto L meccanico
Mechanical L joint
Joint L mécanique
Mechanische L-Verbindung
Junta L mecánica

24TK041 Bianco - White - Blanc
Weiß - Blanco

24TK045 Nero - Black - Noir
Schwarz - Negro



Tappo di chiusura
Dead end
Bouchon
Endkappe
Tapa final

24TK051 Bianco - White - Blanc
Weiß - Blanco

24TK055 Nero - Black - Noir
Schwarz - Negro

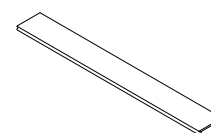

Copertura binario 3mt
Track cover 3mt
Écran 3mt
Schirm 3mt
Pantalla 3mt

24TK061 Bianco - White - Blanc
Weiß - Blanco

24TK065 Nero - Black - Noir
Schwarz - Negro

24VDC TRIMLESS TRACK



24VDC track system for trimless recessed installation.

Sistema di binario 24VDC per installazione a incasso trimless.

Système de voie 24VDC pour une installation encastrée sans bordure.

24VDC Schienensystem für randlosen Einbau.

Sistema de carril 24VDC para instalación empotrada trimless.

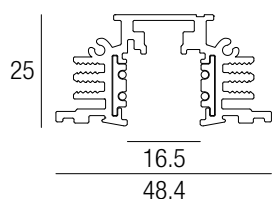

Code Construction

Costruzione del codice - Construction du code produit
Bau der Produkt-Code - Construcción del código de producto

24TT X X

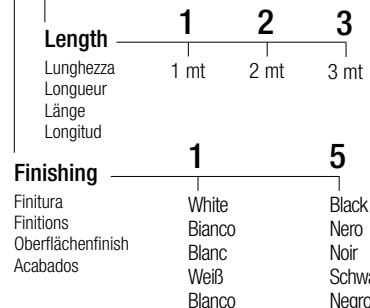

Load schemes - Schemi di carico

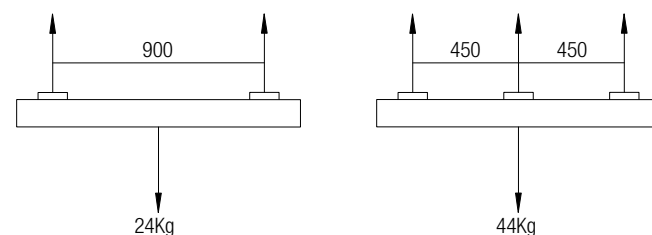

Drivers

Alimentatori - Alimentateurs
Netzteile - Alimentadores

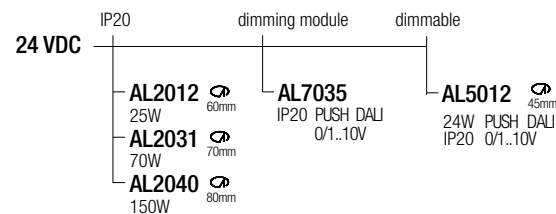

Note: dimming module AL7035 to be used in combination with a 24VDC power supply - **Nota:** modulo di dimmerazione AL7035 da utilizzare in combinazione con un alimentatore 24VDC - **Note:** module de variation AL7035 d'intensité à utiliser en combinaison avec une alimentation 24VDC - **Anmerkung:** Dimmmodul AL7035 zur Verwendung in Kombination mit einem 24VDC-Netzteil - **Nota:** módulo de regulación AL7035 se utiliza en combinación con una fuente de alimentación 24VDC

Accessories - Accessori

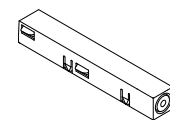

Testata di alimentazione
Live-end
Tête d'alimentation
Macht
Cabezal de alimentación

24TT011 Bianco - White - Blanc
Weiß - Blanco

24TT015 Nero - Black - Noir
Schwarz - Negro

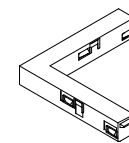

Giunto L elettrico
Electrical L joint
Joint L électrique
Elektrisches L-Verbindung
Junta L eléctrica

24TT031 Bianco - White - Blanc
Weiß - Blanco

24TT035 Nero - Black - Noir
Schwarz - Negro



Tappo di chiusura
Dead end
Bouchon
Endkappe
Tapa final

24TT051 Bianco - White - Blanc
Weiß - Blanco

24TT055 Nero - Black - Noir
Schwarz - Negro

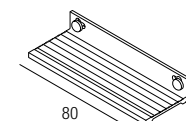

Staffa per installazione trimless
Bracket for trimless installation
Support pour installation sans bordure
Halterung für randlose Installation
Soporte para instalación sin marco

24TT07

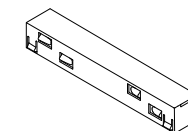

Giunto lineare con contatti
Electrical straight joint
Joint électrique
Elektrische Verbindung
Junta electrica

24TT021 Bianco - White - Blanc
Weiß - Blanco

24TT025 Nero - Black - Noir
Schwarz - Negro

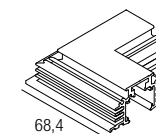

Giunto L meccanico
Mechanical L joint
Joint L mécanique
Mechanische L-Verbindung
Junta L mecánica

24TT041 Bianco - White - Blanc
Weiß - Blanco

24TT045 Nero - Black - Noir
Schwarz - Negro

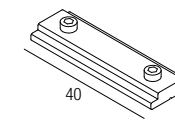

Staffa di rinforzo per giunzione lineare
Reinforcing bracket for linear junction
Support de renfort pour jonction linéaire
Verstärkungsbügel für linearen Anschluss
Soporte de refuerzo para unión lineal

24TT061 Bianco - White - Blanc
Weiß - Blanco

24TT065 Nero - Black - Noir
Schwarz - Negro

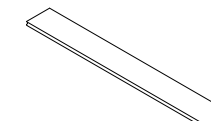

Copertura binario 3mt
Track cover 3mt
Écran 3mt
Schirm 3mt
Pantalla 3mt

24TT081 Bianco - White - Blanc
Weiß - Blanco

24TT085 Nero - Black - Noir
Schwarz - Negro

MINIJOS T2

design: Roberto Mantovani

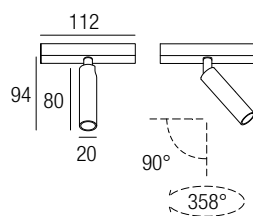
**Supply current**

Alimentazione
Courant d'alimentation
Stromversorgung
Corriente de alimentación

24 VDC**Power**

Potenza
Pouissance
Bestuekung
Potencia

2 W**CCT/CRI/Flux**

2700K — 128 lm
3000K — 133 lm
4200K — 154 lm

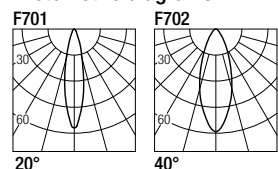
CRI85**2-Step MacAdam****Photometric diagrams****Code Construction**

Costruzione del codice - Construction du code produit
Bau der Produkt-Code - Construcción del código de producto

MJST2 X X X

Beam angle	1	2	
Apertura di fascio	20°	40°	
Angle de faisceau			
Strahlwinkel			
Ángulo del haz			
Color Temperature	2	3	4
Temperatura colore	2700K	3000K	4200K
Température couleur			
Temperaturabhängige Farbe			
Temperatura de color			
Finishing	1	5	
Finitura	White	Black	
Finitions	Bianco	Nero	
Oberflächenfinish	Blanc	Noir	
Acabados	Weiß	Schwarz	
	Blanco	Negro	

Note: versions with extended arm length are available upon request
Nota: versioni con lunghezza del braccetto maggiorata disponibili su richiesta
Note: versions avec longueur du bras majorée disponibles sur demande
Anmerkung: versionen mit erhöhter Armlänge auf Anfrage erhältlich
Nota: Versiones con longitud del brazo aumentada disponible bajo pedido

[DATASHEET ▶](#) [INSTALLATION MANUAL ▶](#)
[CERTIFICATIONS ▶](#) [LDT-IES ▶](#) [DRAWINGS ▶](#)

MINIJOS T6

design: Roberto Mantovani

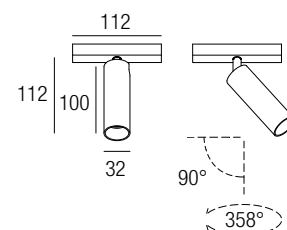
**Supply current**

Alimentazione
Courant d'alimentation
Stromversorgung
Corriente de alimentación

24 VDC**Power**

Potenza
Pouissance
Bestuekung
Potencia

6 W**CCT/CRI/Flux**

2700K — 540 lm
3000K — 600 lm
4000K — 620 lm

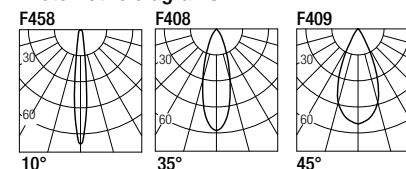
CRI98**2-Step MacAdam****Photometric diagrams****Code Construction**

Costruzione del codice - Construction du code produit
Bau der Produkt-Code - Construcción del código de producto

MJST6 X X X

Beam angle	0	1	2
Apertura di fascio	10°	35°	45°
Angle de faisceau			
Strahlwinkel			
Ángulo del haz			
Color Temperature	2	3	4
Temperatura colore	2700K	3000K	4000K
Température couleur			
Temperaturabhängige Farbe			
Temperatura de color			
Finishing	1	5	
Finitura	White	Black	
Finitions	Bianco	Nero	
Oberflächenfinish	Blanc	Noir	
Acabados	Weiß	Schwarz	
	Blanco	Negro	

Note: versions with extended arm length are available upon request
Nota: versioni con lunghezza del braccetto maggiorata disponibili su richiesta
Note: versions avec longueur du bras majorée disponibles sur demande
Anmerkung: versionen mit erhöhter Armlänge auf Anfrage erhältlich
Nota: Versiones con longitud del brazo aumentada disponible bajo pedido

[DATASHEET ▶](#) [INSTALLATION MANUAL ▶](#)
[CERTIFICATIONS ▶](#) [LDT-IES ▶](#) [DRAWINGS ▶](#)
**Accessories**

Accessori - Accessoires
Zubehör - Accesorios

LJ02	LJ02B	SJ02	SJ02B
White	Black	White	Black
Bianco	Nero	Bianco	Nero
Blanc	Noir	Blanc	Noir
Weiß	Schwarz	Weiß	Schwarz
Blanco	Negro	Blanco	Negro
Low luminance louver		Milky screen	
Filtro antiabbagliamento		Schermo opale	
Filtre basse luminance		Écran opale	
Geringe Leuchtdichte-Filter		Opal-Bildschirm	
Filtro de baja luminancia		Pantalla opal	

MINIJOS T10

design: Roberto Mantovani

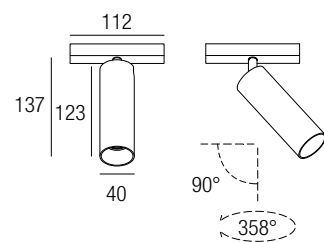

Supply current

Alimentazione
Courant d'alimentation
Stromversorgung
Corriente de alimentación

24 VDC

Power

Potenza
Pouissance
Bestuekung
Potencia

10 W



Photometric diagrams

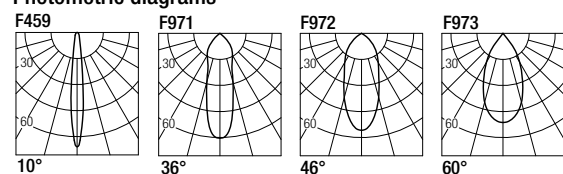

CCT/CRI/Flux

	CRI85	CRI93
2700K	890 lm	840 lm
3000K	1000 lm	930 lm
4000K	1040 lm	960 lm

CRI85 - CRI93
2-Step MacAdam

Code Construction

Costruzione del codice - Construction du code produit
Bau der Produkt-Code - Construcción del código de producto

MJST1 X X X X

Beam angle

Apertura di fascio
Angle de faisceau
Strahlwinkel
Ángulo del haz

N	S	M	W	X
10°	36°	46°	60°	10-55°

Adjustable optics
Optica variabile
Optique réglable
Einstellbarer Optik
Óptica ajustable

CRI

8	9
85	93

Color Temperature

Temperatura colore
Température couleur
Temperaturabhängige Farbe
Temperatura de color

2	3	4
2700K	3000K	4000K

Finishing

Finitura
Finitions
Oberflächenfinish
Acabados

1	5
White	Black
Bianco	Nero
Blanc	Noir
Weiß	Schwarz
Blanco	Negro

[DATASHEET ▶](#)
[INSTALLATION MANUAL ▶](#)
[CERTIFICATIONS ▶](#)
[LDT-IES ▶](#)
[DRAWINGS ▶](#)

Accessories

Accessori - Accessoires
Zubehör - Accesorios

LJ01

White
Bianco
Blanc
Weiß
Blanco

LJ01B

Black
Nero
Noir
Schwarz
Negro

SJ01

White
Bianco
Blanc
Weiß
Blanco

SJ01B

Black
Nero
Noir
Schwarz
Negro

Low luminance louver
Filtro antiabbagliamento
Filtre basse luminance
Geringe Leuchtdichte-Filter
Filtro de baja luminancia



Milky screen
Schermo opale
Écran opale
Opal-Bildschirm
Pantalla opal



Note: the filter and the screen are not available in adjustable optics version 10-55° - **Nota:** il filtro e lo schermo non sono disponibili nella versione ad ottica regolabile 10-55° - **Note:** le filtre et l'écran ne sont pas disponibles dans la version à optique réglable 10-55° - **Anmerkung:** Filter und Bildschirm sind in der einstellbaren optischen Version 10-55° nicht verfügbar - **Nota:** el filtro y la pantalla no están disponibles en la versión de óptica ajustable 10-55°

Note: versions with extended arm length are available upon request
Nota: versioni con lunghezza del braccetto maggiorata disponibili su richiesta
Note: versions avec longueur du bras majorée disponibles sur demande
Anmerkung: versionen mit erhöhter Armlänge auf Anfrage erhältlich
Nota: Versiones con longitud del brazo aumentada disponible bajo pedido



JOS T2

design: Roberto Mantovani

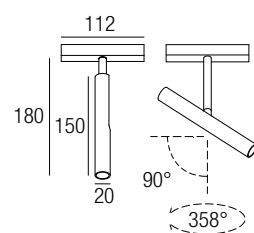

Supply current
Alimentazione
Courant d'alimentation
Stromversorgung
Corriente de alimentación
24 VDC

Power
Potenza
Puissance
Bestuekung
Potencia
2 W



CCT/CRI/Flux

2700K — 128 lm
3000K — 133 lm
4200K — 154 lm

Photometric diagrams

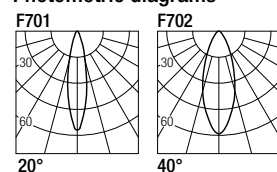

CRI85
2-Step MacAdam

Code Construction

Costruzione del codice - Construction du code produit
Bau der Produkt-Code - Construcción del código de producto

JST2 X X X

Beam angle	1	2	
Apertura di fascio	20°	40°	
Angle de faisceau			
Strahlwinkel			
Ángulo del haz			
Color Temperature	2	3	4
Temperatura colore	2700K	3000K	4200K
Température couleur			
Temperaturabhängige Farbe			
Temperatura de color			
Finishing	1	5	
Finitura	White	Black	
Finitions	Bianco	Nero	
Oberflächenfinish	Blanc	Noir	
Acabados	Weiß	Schwarz	
	Blanco	Negro	

Note: versions with extended arm length are available upon request **Nota:** versioni con lunghezza del braccetto maggiorata disponibili su richiesta **Note:** versions avec longueur du bras majorée disponibles sur demande **Anmerkung:** versionen mit erhöhter Armlänge auf Anfrage erhältlich **Nota:** Versiones con longitud del brazo aumentada disponible bajo pedido

DATASHEET ▶ INSTALLATION MANUAL ▶
CERTIFICATIONS ▶ LDT-IES ▶ DRAWINGS ▶



JOS T6

design: Roberto Mantovani

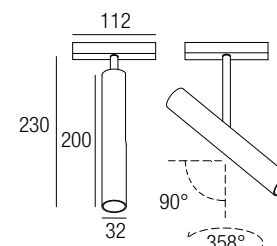

Supply current
Alimentazione
Courant d'alimentation
Stromversorgung
Corriente de alimentación
24 VDC

Power
Potenza
Puissance
Bestuekung
Potencia
6 W



CCT/CRI/Flux

2700K — 540 lm
3000K — 600 lm
4000K — 620 lm

Photometric diagrams

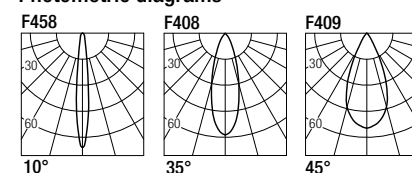

CRI98
2-Step MacAdam

Code Construction

Costruzione del codice - Construction du code produit
Bau der Produkt-Code - Construcción del código de producto

JST6 X X X

Beam angle	0	1	2
Apertura di fascio	10°	35°	45°
Angle de faisceau			
Strahlwinkel			
Ángulo del haz			
Color Temperature	2	3	4
Temperatura colore	2700K	3000K	4000K
Température couleur			
Temperaturabhängige Farbe			
Temperatura de color			
Finishing	1	5	
Finitura	White	Black	
Finitions	Bianco	Nero	
Oberflächenfinish	Blanc	Noir	
Acabados	Weiß	Schwarz	
	Blanco	Negro	

Note: versions with extended arm length are available upon request **Nota:** versioni con lunghezza del braccetto maggiorata disponibili su richiesta **Note:** versions avec longueur du bras majorée disponibles sur demande **Anmerkung:** versionen mit erhöhter Armlänge auf Anfrage erhältlich **Nota:** Versiones con longitud del brazo aumentada disponible bajo pedido

DATASHEET ▶ INSTALLATION MANUAL ▶
CERTIFICATIONS ▶ LDT-IES ▶ DRAWINGS ▶



Accessories

Accessori - Accessoires
Zubehör - Accesorios

LJ02	LJ02B	SJ02	SJ02B
White	Black	White	Black
Bianco	Nero	Bianco	Nero
Blanc	Noir	Blanc	Noir
Weiß	Schwarz	Weiß	Schwarz
Blanco	Negro	Blanco	Negro
Low luminance louver		Milky screen	
Filtro antiabbagliamento		Schermo opale	
Filtre basse luminance		Écran opale	
Geringe Leuchtdichte-Filter		Opal-Bildschirm	
Filtro de baja luminancia		Pantalla opal	

JOS T10

design: Roberto Mantovani

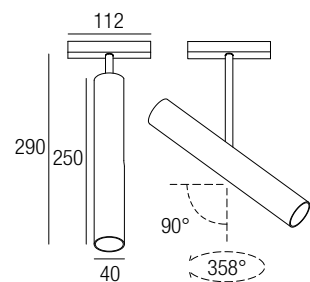

Supply current

Alimentazione
Courant d'alimentation
Stromversorgung
Corriente de alimentación

24 VDC

Power

Potenza
Puissance
Bestuekung
Potencia

10 W



Photometric diagrams

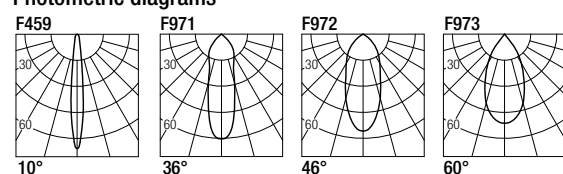

CCT/CRI/Flux

	CRI85	CRI93
2700K	890 lm	840 lm
3000K	1000 lm	930 lm
4000K	1040 lm	960 lm

CRI85 - CRI93

2-Step MacAdam

Code Construction

Costruzione del codice - Construction du code produit
Bau der Produkt-Code - Construcción del código de producto

JST1 X X X X

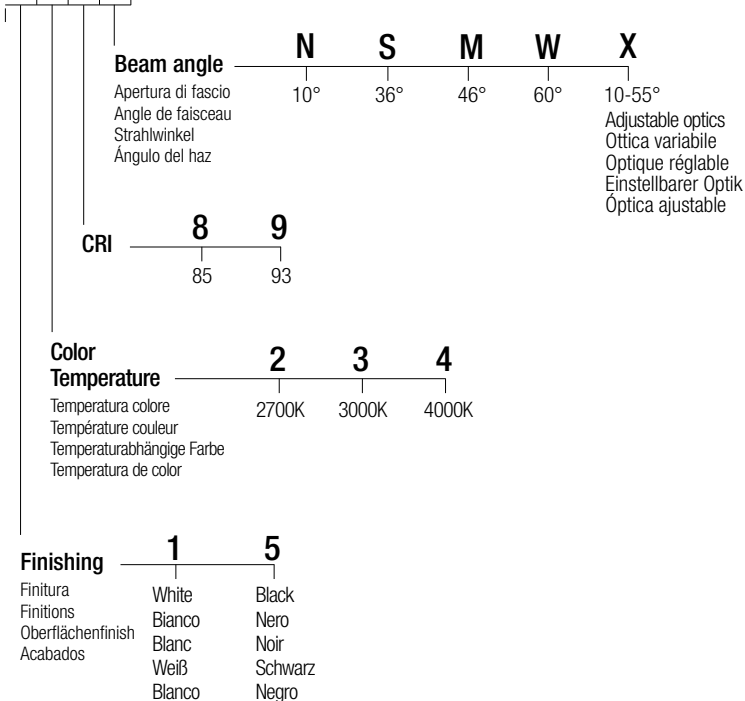

Note: versions with extended arm length are available upon request
Nota: versioni con lunghezza del braccetto maggiorata disponibili su richiesta
Note: versions avec longueur du bras majorée disponibles sur demande
Anmerkung: versionen mit erhöhter Armlänge auf Anfrage erhältlich
Nota: Versiones con longitud del brazo aumentada disponible bajo pedido

[DATASHEET ▶](#) [INSTALLATION MANUAL ▶](#)
[CERTIFICATIONS ▶](#) [LDT-IES ▶](#) [DRAWINGS ▶](#)

Accessories

Accessori - Accessoires
Zubehör - Accesorios

LJ01	LJ01B	SJ01	SJ01B
White	Black	White	Black
Bianco	Nero	Bianco	Nero
Blanc	Noir	Blanc	Noir
Weiß	Schwarz	Weiß	Schwarz
Bianco	Negro	Bianco	Negro

Low luminance louver
Filtro antiabbagliamento
Filtre basse luminance
Geringe Leuchtdichte-Filter
Filtro de baja luminancia



Milky screen
Schermo opale
Écran opale
Opal-Bildschirm
Pantalla opal



Note: the filter and the screen are not available in adjustable optics version 10-55° - **Nota:** il filtro e lo schermo non sono disponibili nella versione ad ottica regolabile 10-55° - **Note:** le filtre et l'écran ne sont pas disponibles dans la version à optique réglable 10-55° - **Anmerkung:** Filter und Bildschirm sind in der einstellbaren optischen Version 10-55° nicht verfügbar - **Nota:** el filtro y la pantalla no están disponibles en la versión de óptica ajustable 10-55°

LAD T6

design: Roberto Mantovani

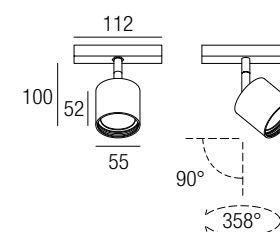

Supply current

Alimentazione
Courant d'alimentation
Stromversorgung
Corriente de alimentación

24 VDC

Power

Potenza
Puissance
Bestuekung
Potencia

6 W



Photometric diagrams

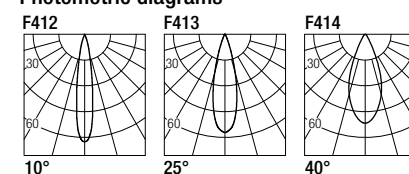

CCT/CRI/Flux

	540 lm
2700K	540 lm
3000K	600 lm
4000K	620 lm

CRI98

2-Step MacAdam

Code Construction

Costruzione del codice - Construction du code produit
Bau der Produkt-Code - Construcción del código de producto

LADT6 X X X

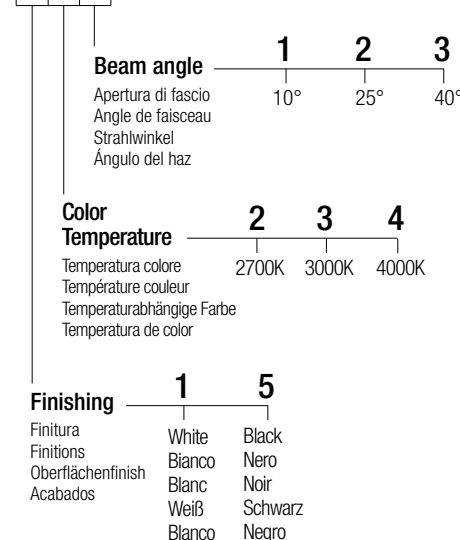

Note: versions with extended arm length are available upon request
Nota: versioni con lunghezza del braccetto maggiorata disponibili su richiesta
Note: versions avec longueur du bras majorée disponibles sur demande
Anmerkung: versionen mit erhöhter Armlänge auf Anfrage erhältlich
Nota: Versiones con longitud del brazo aumentada disponible bajo pedido

[DATASHEET ▶](#) [INSTALLATION MANUAL ▶](#)
[CERTIFICATIONS ▶](#) [LDT-IES ▶](#) [DRAWINGS ▶](#)

Accessories

Accessori - Accessoires
Zubehör - Accesorios

LL02	LL02B	SL02	SL02B
White	Black	White	Black
Bianco	Nero	Bianco	Nero
Blanc	Noir	Blanc	Noir
Weiß	Schwarz	Weiß	Schwarz
Bianco	Negro	Bianco	Negro

Low luminance louver
Filtro antiabbagliamento
Filtre basse luminance
Geringe Leuchtdichte-Filter
Filtro de baja luminancia



Milky screen
Schermo opale
Écran opale
Opal-Bildschirm
Pantalla opal



LAD T10

design: Roberto Mantovani

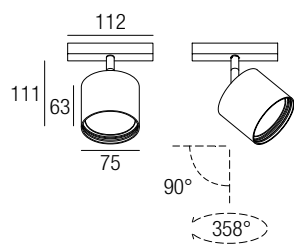
**Supply current**

Alimentazione
Courant d'alimentation
Stromversorgung
Corriente de alimentación

24 VDC**Power**

Potenza
Puissance
Bestuekung
Potencia

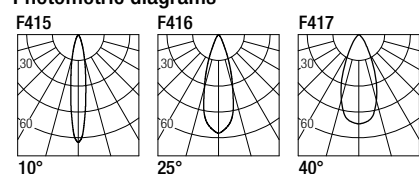
10 W**Photometric diagrams****CCT/CRI/Flux**

	CRI85	CRI93
2700K	890 lm	840 lm
3000K	1000 lm	930 lm
4000K	1040 lm	960 lm

CRI85 - CRI93
2-Step MacAdam

Code Construction

Costruzione del codice - Construction du code produit
Bau der Produkt-Code - Construcción del código de producto

LADT1 X X X X

Beam angle	N	S	M
Apertura di fascio Angle de faisceau Strahlwinkel Ángulo del haz	10°	25°	40°
CRI	8	9	
	85	93	
Color Temperature	2	3	4
Temperatura colore Température couleur Temperaturabhängige Farbe Temperatura de color	2700K	3000K	4000K
Finishing	1	5	
Finitura Finitions Oberflächenfinish Acabados	White Bianco Blanc Weiß Blanco	Black Nero Noir Schwarz Negro	

Note: versions with extended arm length are available upon request
Nota: versioni con lunghezza del braccetto maggiorata disponibili su richiesta
Note: versions avec longueur du bras majorée disponibles sur demande
Anmerkung: versionen mit erhöhter Armlänge auf Anfrage erhältlich
Nota: Versiones con longitud del brazo aumentada disponible bajo pedido

[DATASHEET ▶](#) [INSTALLATION MANUAL ▶](#)
[CERTIFICATIONS ▶](#) [LDT-IES ▶](#) [DRAWINGS ▶](#)

LAD T10 WALL WASHER

design: Roberto Mantovani

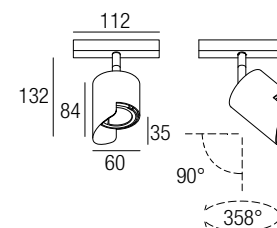
**Supply current**

Alimentazione
Courant d'alimentation
Stromversorgung
Corriente de alimentación

24 VDC**Power**

Potenza
Puissance
Bestuekung
Potencia

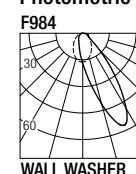
10 W**Photometric diagrams****CCT/CRI/Flux**

	CRI85	CRI93
2700K	890 lm	840 lm
3000K	1000 lm	930 lm
4000K	1040 lm	960 lm

CRI85 - CRI93
2-Step MacAdam

Code Construction

Costruzione del codice - Construction du code produit
Bau der Produkt-Code - Construcción del código de producto

LADTW X X X

CRI	8	9	
	85	93	
Color Temperature	2	3	4
Temperatura colore Température couleur Temperaturabhängige Farbe Temperatura de color	2700K	3000K	4000K
Finishing	1	5	
Finitura Finitions Oberflächenfinish Acabados	White Bianco Blanc Weiß Blanco	Black Nero Noir Schwarz Negro	

Note: versions with extended arm length are available upon request
Nota: versioni con lunghezza del braccetto maggiorata disponibili su richiesta
Note: versions avec longueur du bras majorée disponibles sur demande
Anmerkung: versionen mit erhöhter Armlänge auf Anfrage erhältlich
Nota: Versiones con longitud del brazo aumentada disponible bajo pedido

[DATASHEET ▶](#) [INSTALLATION MANUAL ▶](#)
[CERTIFICATIONS ▶](#) [LDT-IES ▶](#) [DRAWINGS ▶](#)

JOS T2P

design: Roberto Mantovani

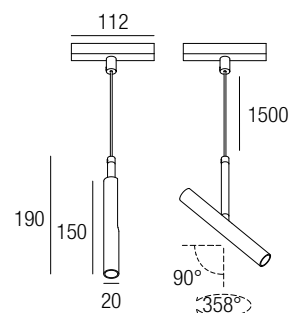
**Supply current**

Alimentazione
Courant d'alimentation
Stromversorgung
Corriente de alimentación

24 VDC**Power**

Potenza
Puissance
Bestuekung
Potencia

2 W**CCT/CRI/Flux**

2700K — 128 lm
3000K — 133 lm
4200K — 154 lm

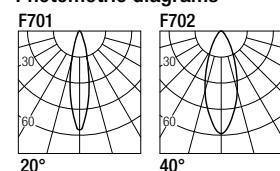
Photometric diagrams**CRI85****2-Step MacAdam****Code Construction**

Costruzione del codice - Construction du code produit
Bau der Produkt-Code - Construcción del código de producto

JST2P X X X

Beam angle	1	2	
Apertura di fascio	20°	40°	
Angle de faisceau			
Strahlwinkel			
Ángulo del haz			
Color Temperature	2	3	4
Temperatura colore	2700K	3000K	4200K
Température couleur			
Temperaturabhängige Farbe			
Temperatura de color			
Finishing	1	5	
Finitura	White	Black	
Finitions	Bianco	Nero	
Oberflächenfinish	Blanc	Noir	
Acabados	Weiß	Schwarz	
	Blanco	Negro	

Note: cable cut to measure on request**Nota:** cavo a misura disponibile su richiesta**Note:** câble sur mesure disponible sur demande**Anmerkung:** kundenspezifisches Kabel auf Anfrage erhältlich**Nota:** cable a medida disponible a petición
[DATASHEET](#) [INSTALLATION MANUAL](#)
[CERTIFICATIONS](#) [LDT-IES](#) [DRAWINGS](#)

JOS T6P

design: Roberto Mantovani

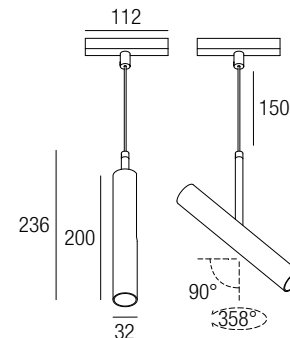
**Supply current**

Alimentazione
Courant d'alimentation
Stromversorgung
Corriente de alimentación

24 VDC**Power**

Potenza
Puissance
Bestuekung
Potencia

6 W**CCT/CRI/Flux**

2700K — 540 lm
3000K — 600 lm
4000K — 620 lm

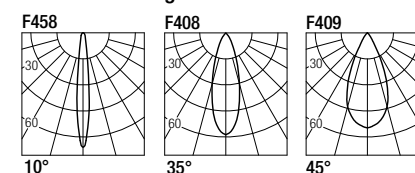
Photometric diagrams**CRI98****2-Step MacAdam****Code Construction**

Costruzione del codice - Construction du code produit
Bau der Produkt-Code - Construcción del código de producto

JST6P X X X

Beam angle	0	1	2
Apertura di fascio	10°	35°	45°
Angle de faisceau			
Strahlwinkel			
Ángulo del haz			
Color Temperature	2	3	4
Temperatura colore	2700K	3000K	4000K
Température couleur			
Temperaturabhängige Farbe			
Temperatura de color			
Finishing	1	5	
Finitura	White	Black	
Finitions	Bianco	Nero	
Oberflächenfinish	Blanc	Noir	
Acabados	Weiß	Schwarz	
	Blanco	Negro	

Note: cable cut to measure on request**Nota:** cavo a misura disponibile su richiesta**Note:** câble sur mesure disponible sur demande**Anmerkung:** kundenspezifisches Kabel auf Anfrage erhältlich**Nota:** cable a medida disponible a petición
[DATASHEET](#) [INSTALLATION MANUAL](#)
[CERTIFICATIONS](#) [LDT-IES](#) [DRAWINGS](#)
**Accessories**

Accessori - Accessoires
Zubehör - Accesorios

LJ02

White
Bianco
Blanc
Weiß
Blanco

LJ02B

Black
Nero
Noir
Schwarz
Negro

SJ02

White
Bianco
Blanc
Weiß
Blanco

SJ02B

Black
Nero
Noir
Schwarz
Negro

Low luminance louver
Filtro antiabbagliamento
Filtre basse luminance
Geringe Leuchtdichte-Filter
Filtro de baja luminancia



Milky screen
Schermo opale
Écran opale
Opal-Bildschirm
Pantalla opal



JOS T10P

design: Roberto Mantovani

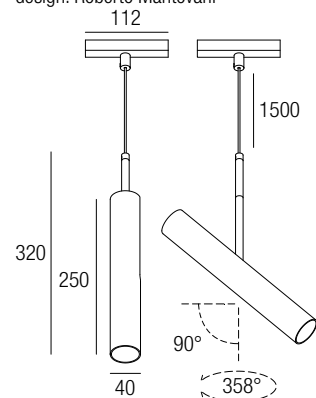

Supply current
Alimentazione
Courant d'alimentation
Stromversorgung
Corriente de alimentación
24 VDC

Power
Potenza
Puissance
Bestuekung
Potencia
10 W



Photometric diagrams

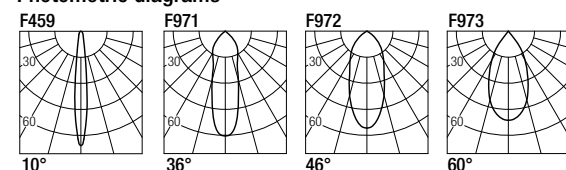

CCT/CRI/Flux

	CRI85	CRI93
2700K	890 lm	840 lm
3000K	1000 lm	930 lm
4000K	1040 lm	960 lm

CRI85 - CRI93
2-Step MacAdam

Code Construction

Costruzione del codice - Construction du code produit
Bau der Produkt-Code - Construcción del código de producto

JST1P X X X X

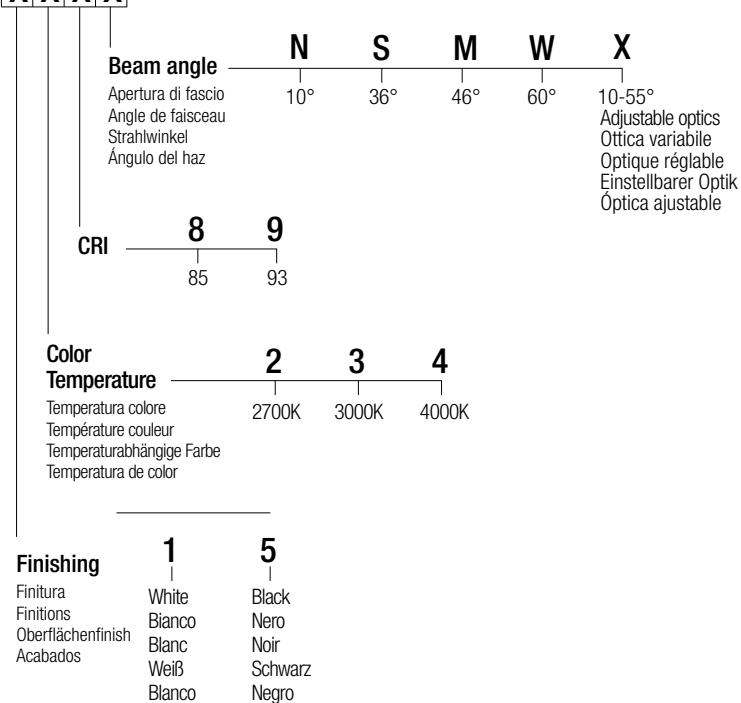

Note: cable cut to measure on request

Nota: cavo a misura disponibile su richiesta

Note: câble sur mesure disponible sur demande

Anmerkung: kundenspezifisches Kabel auf Anfrage erhältlich

Nota: cable a medida disponible a petición

[DATASHEET](#) ▶ [INSTALLATION MANUAL](#) ▶

[CERTIFICATIONS](#) ▶ [LDT-IES](#) ▶ [DRAWINGS](#) ▶



Accessories

Accessori - Accessoires
Zubehör - Accesorios

LJ01	LJ01B	SJ01	SJ01B
White	Black	White	Black
Bianco	Nero	Bianco	Nero
Blanc	Noir	Blanc	Noir
Weiß	Schwarz	Weiß	Schwarz
Blanco	Negro	Blanco	Negro
Low luminance louver		Milky screen	
Filtro antiabbagliamento		Schermo opale	
Filtre basse luminance		Écran opale	
Geringe Leuchtdichte-Filter		Opal-Bildschirm	
Filtro de baja luminancia		Pantalla opal	

Note: the filter and the screen are not available in adjustable optics version 10-55° - **Nota:** il filtro e lo schermo non sono disponibili nella versione ad ottica regolabile 10-55° - **Note:** le filtre et l'écran ne sont pas disponibles dans la version à optique réglable 10-55° - **Anmerkung:** Filter und Bildschirm sind in der einstellbaren optischen Version 10-55° nicht verfügbar - **Nota:** el filtro y la pantalla no están disponibles en la versión de óptica ajustable 10-55°

GAGARIN T2

design: Roberto Mantovani

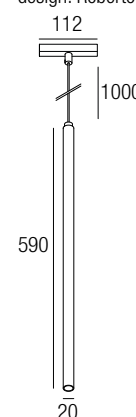

Supply current
Alimentazione
Courant d'alimentation
Stromversorgung
Corriente de alimentación
24 VDC

Power
Potenza
Puissance
Bestuekung
Potencia
2 W



Photometric diagrams

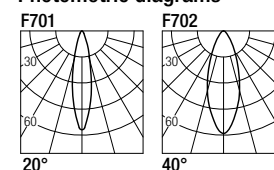

CCT/CRI/Flux

	CRI85
2700K	128 lm
3000K	133 lm
4200K	154 lm

CRI85
2-Step MacAdam

Code Construction

Costruzione del codice - Construction du code produit
Bau der Produkt-Code - Construcción del código de producto

GT2 X X X

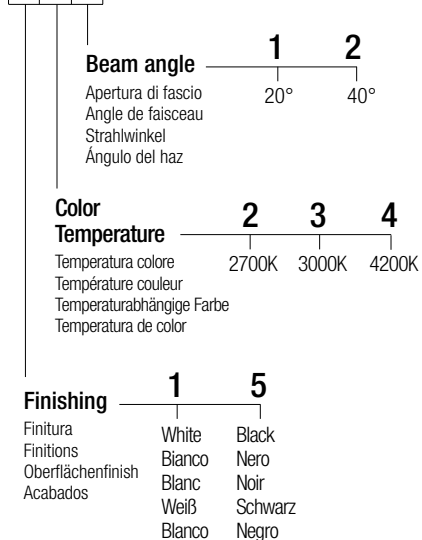

Note: cable cut to measure on request

Nota: cavo a misura disponibile su richiesta

Note: câble sur mesure disponible sur demande

Anmerkung: kundenspezifisches Kabel auf Anfrage erhältlich

Nota: cable a medida disponible a petición

[DATASHEET](#) ▶ [INSTALLATION MANUAL](#) ▶

[CERTIFICATIONS](#) ▶ [LDT-IES](#) ▶ [DRAWINGS](#) ▶



GAGARIN T6

design: Roberto Mantovani

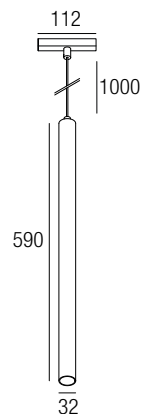
**Supply current**

Alimentazione
Courant d'alimentation
Stromversorgung
Corriente de alimentación

24 VDC**Power**

Potenza
Puissance
Bestuekung
Potencia

6 W**CCT/CRI/Flux**

2700K — 540 lm
3000K — 600 lm
4000K — 620 lm

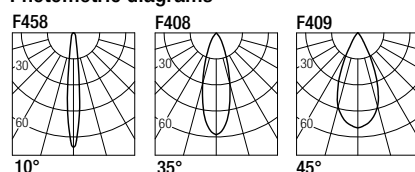
CRI98**2-Step MacAdam****Photometric diagrams****Code Construction**

Costruzione del codice - Construction du code produit
Bau der Produkt-Code - Construcción del código de producto

GT6 X X X

Beam angle	0	1	2
Apertura di fascio Angle de faisceau Strahlwinkel Ángulo del haz	10°	35°	45°
Color Temperature	2	3	4
Temperatura colore Température couleur Temperaturabhängige Farbe Temperatura de color	2700K	3000K	4000K
Finishing	1	5	
Finitura Finitions Oberflächenfinish Acabados	White Bianco Blanc Weiß Blanco	Black Nero Noir Schwarz Negro	

Note: cable cut to measure on request**Nota:** cavo a misura disponibile su richiesta**Note:** câble sur mesure disponible sur demande**Anmerkung:** kundenspezifisches Kabel auf Anfrage erhältlich**Nota:** cable a medida disponible a petición

DATASHEET ▶ INSTALLATION MANUAL ▶
CERTIFICATIONS ▶ LDT-IES ▶ DRAWINGS ▶

**Accessories**

Accessori - Accessoires
Zubehör - Accesorios

LJ02

White
Bianco
Blanc
Weiß
Blanco

LJ02B

Black
Nero
Noir
Schwarz
Negro

Low luminance louver
Filtro antiabbagliamento
Filtre basse luminance
Geringe Leuchtdichte-Filter
Filtro de baja luminancia

**SJ02**

White
Bianco
Blanc
Weiß
Blanco

SJ02B

Black
Nero
Noir
Schwarz
Negro

Milky screen
Schermo opale
Écran opale
Opal-Bildschirm
Pantalla opal



GAGARIN T10

design: Roberto Mantovani

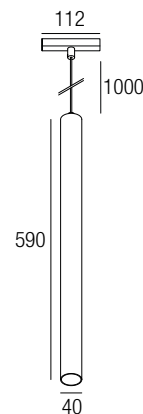
**Supply current**

Alimentazione
Courant d'alimentation
Stromversorgung
Corriente de alimentación

24 VDC**Power**

Potenza
Puissance
Bestuekung
Potencia

10 W**CCT/CRI/Flux**

CRI85 CRI93
2700K — 890 lm 840 lm
3000K — 1000 lm 930 lm
4000K — 1040 lm 960 lm

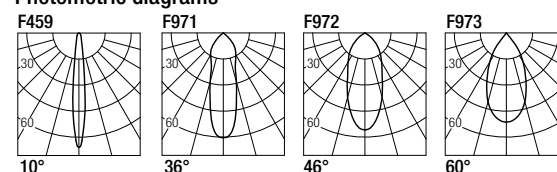
CRI85 - CRI93**2-Step MacAdam****Photometric diagrams****Code Construction**

Costruzione del codice - Construction du code produit
Bau der Produkt-Code - Construcción del código de producto

GT1 X X X X

Beam angle	N	S	M	W	X
Apertura di fascio Angle de faisceau Strahlwinkel Ángulo del haz	10°	36°	46°	60°	10-55°
CRI	8	9			
	85	93			
Color Temperature	2	3	4		
Temperatura colore Température couleur Temperaturabhängige Farbe Temperatura de color	2700K	3000K	4000K		
Finishing	1	5			
Finitura Finitions Oberflächenfinish Acabados	White Bianco Blanc Weiß Blanco	Black Nero Noir Schwarz Negro			

Note: cable cut to measure on request**Nota:** cavo a misura disponibile su richiesta**Note:** câble sur mesure disponible sur demande**Anmerkung:** kundenspezifisches Kabel auf Anfrage erhältlich**Nota:** cable a medida disponible a petición

DATASHEET ▶ INSTALLATION MANUAL ▶
CERTIFICATIONS ▶ LDT-IES ▶ DRAWINGS ▶

**Accessories**

Accessori - Accessoires
Zubehör - Accesorios

LJ01

White
Bianco
Blanc
Weiß
Blanco

LJ01B

Black
Nero
Noir
Schwarz
Negro

Low luminance louver
Filtro antiabbagliamento
Filtre basse luminance
Geringe Leuchtdichte-Filter
Filtro de baja luminancia

**SJ01**

White
Bianco
Blanc
Weiß
Blanco

SJ01B

Black
Nero
Noir
Schwarz
Negro

Milky screen
Schermo opale
Écran opale
Opal-Bildschirm
Pantalla opal



Note: the filter and the screen are not available in adjustable optics version 10-55° - **Nota:** il filtro e lo schermo non sono disponibili nella versione ad ottica regolabile 10-55° - **Note:** le filtre et l'écran ne sont pas disponibles dans la version à optique réglable 10-55° - **Anmerkung:** Filter und Bildschirm sind in der einstellbaren optischen Version 10-55° nicht verfügbar - **Nota:** el filtro y la pantalla no están disponibles en la versión de óptica ajustable 10-55°

MAGGY

The Maggy linear system allows the trimless installation of 36mm or 72mm width that can be equipped with various light modules fastened to the structure via magnets. The side slots on the duct allow repositioning of the individual elements at any time.

Il sistema lineare Maggy permette la realizzazione di tagli trimless di larghezza 36mm o 72mm, equipaggiabili con moduli luminosi di varie tipologie fissati alla struttura tramite calamite. Le asole laterali presenti sul canale consentono di posizionare gli apparecchi in qualsiasi punto, variandone la posizione in qualsiasi momento.

Le système linéaire Maggy permet la réalisation de coupés trimless de largeur 36 mm ou 72 mm, qui peuvent être équipés de modules lumineux de différentes typologies placés sur la structure par le biais d'aimants. Les fentes latérales présentes sur le canal permettent de positionner les appareils à n'importe quel endroit et de varier la position à tout moment.

Das lineare System Maggy ermöglicht die Herstellung von Einschnitten trimless mit einer Breite von 36 mm oder 72 mm, die mit Lichtmodulen von verschiedener Art ausgestattet werden können, die mit Magneten an der Struktur anhaften. Die seitlichen Ösen an dem Kanal ermöglichen die Positionierung der Geräte an beliebigen Punkten und somit die Veränderung der Position zu jeder Zeit.

El sistema lineal Maggy permite la realización de cortes trimless de 36mm o 72mm de ancho que pueden equiparse con módulos luminosos de distintos tipos fijados a la estructura mediante imanes. Las ranuras laterales presentes en el canal permiten colocar los aparatos en cualquier punto, pudiendo variar su posición en cualquier momento.

Module installation

1

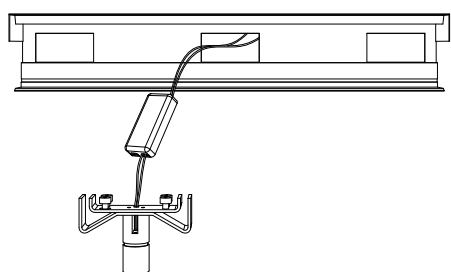

Wire the product and pass the power supply through the side holes of the duct.

2

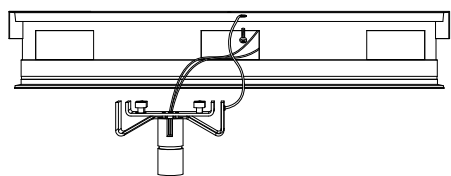

Fix the fall protection cable to the structure.

3

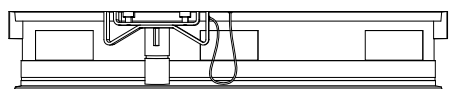

Insert the light module into the structure and position it. The module attaches magnetically.



MAGGY 36

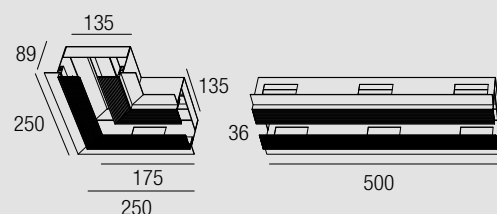

MG36-L01

L-module

Modulo L
L-Modul
Módulo L

MG36-ST50

Straight module 50cm

Modulo lineare 50cm
Module droit 50cm
Gerades Modul 50cm
Módulo recto 50cm

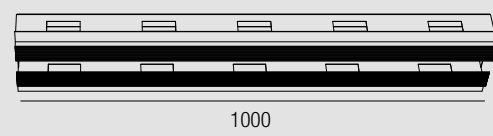

MG36-ST100

Straight module 100cm

Modulo lineare 100cm
Module droit 100cm
Gerades Modul 100cm
Módulo recto 100cm

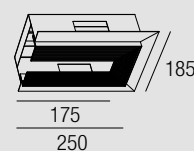

MG36-C01

End-module

Modulo di testata
Module d'extrémité
Endmodul
Módulo final

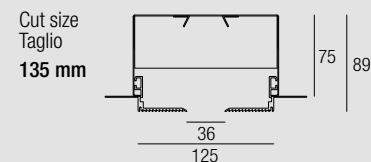

MAGGY 72

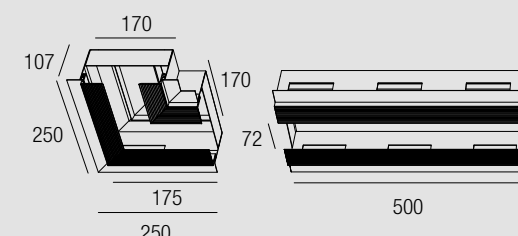

MG72-L01

L-module

Modulo L
L-Modul
Módulo L

MG72-ST50

Straight module 50cm

Modulo lineare 50cm
Module droit 50cm
Gerades Modul 50cm
Módulo recto 50cm

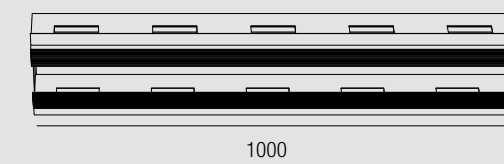

MG72-ST100

Straight module 100cm

Modulo lineare 100cm
Module droit 100cm
Gerades Modul 100cm
Módulo recto 100cm

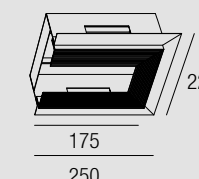

MG72-C01

End-module

Modulo di testata
Module d'extrémité
Endmodul
Módulo final

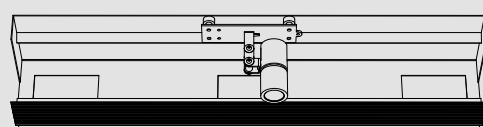
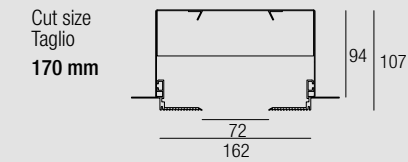

LEONARD 36 ADJUSTABLE DOWNLIGHT MODULE

The highly orientable Leonard module remains entirely within the structure, guaranteeing maximum functionality and total invisibility of the illuminator.

Il modulo Leonard, di elevata orientabilità, rimane interamente all'interno della struttura, garantendo la massima funzionalità combinata alla totale invisibilità dell'illuminatore.

Das Modul Leonard mit verbesserter Ausrichtung, bleibt vollständig im System der Struktur und garantiert maximale Funktionalität kombiniert mit totaler Unsichtbarkeit des Beleuchtungskörpers.

Le module Leonard, de grande orientabilité, reste entièrement à l'intérieur de la structure pour garantir la fonctionnalité maximale associée à la totale invisibilité de l'élément éclairant.

El módulo Leonard, sumamente orientable, queda totalmente englobado en la estructura, garantizando la máxima funcionalidad junto con la total invisibilidad de la fuente de iluminación.

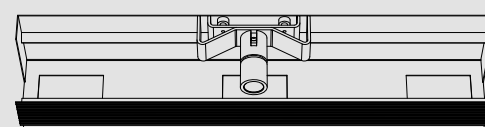

DAVID 36 FIXED DOWNLIGHT MODULE

The David fixed module, remaining entirely within the structure, has negligible visual impact.

Il modulo David, fisso, rimane interamente all'interno della struttura, con un'alta prestazione ed un impatto visivo nullo.

Das feststehende Modul David bleibt vollständig im System der Struktur, mit hoher Leistung und nicht sichtbar.

Le module David, fixe, reste entièrement à l'intérieur de la structure, avec une prestation élevée et un impact visuel nul.

El módulo David, fijo, queda totalmente englobado dentro de la estructura, con una alta prestación y un impacto visual nulo.

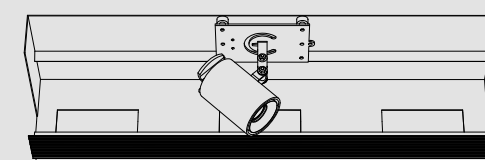

LEONARD 72 ADJUSTABLE DOWNLIGHT MODULE

The highly orientable Leonard module remains entirely within the structure, guaranteeing maximum functionality and total invisibility of the illuminator.

Il modulo Leonard, di elevata orientabilità, rimane interamente all'interno della struttura, garantendo la massima funzionalità combinata alla totale invisibilità dell'illuminatore.

Das Modul Leonard mit verbesserter Ausrichtung, bleibt vollständig im System der Struktur und garantiert maximale Funktionalität kombiniert mit totaler Unsichtbarkeit des Beleuchtungskörpers.

Le module Leonard, de grande orientabilité, reste entièrement à l'intérieur de la structure pour garantir la fonctionnalité maximale associée à la totale invisibilité de l'élément éclairant.

El módulo Leonard, sumamente orientable, queda totalmente englobado en la estructura, garantizando la máxima funcionalidad junto con la total invisibilidad de la fuente de iluminación.

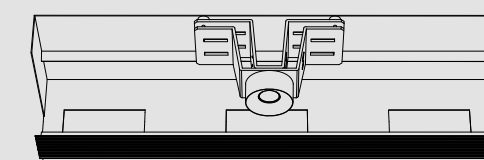

DAVID 72 FIXED DOWNLIGHT MODULE

The David fixed module, remaining entirely within the structure, has negligible visual impact.

Il modulo David, fisso, rimane interamente all'interno della struttura, con un'alta prestazione ed un impatto visivo nullo.

Das feststehende Modul David bleibt vollständig im System der Struktur, mit hoher Leistung und nicht sichtbar.

Le module David, fixe, reste entièrement à l'intérieur de la structure, avec une prestation élevée et un impact visuel nul.

El módulo David, fijo, queda totalmente englobado dentro de la estructura, con una alta prestación y un impacto visual nulo.

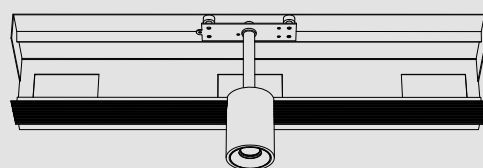

PRINCE 36 EXTERNAL PROJECTOR MODULE

The Prince module provides a fully orientable spotlight that extends out of the system.

Il modulo Prince permette di avere un proiettore completamente orientabile che esce dal sistema.

Das Modul Prince macht es möglich, eine komplett ausrichtbare Leuchte zu erhalten, die das System verlässt.

Le module Prince permet d'avoir un projecteur complètement orientable qui sort du système.

El módulo Prince permite tener un proyector completamente orientable que sobresale del sistema.



BEN 36 DIFFUSED LIGHT MODULE

The Ben linear module provides a line of diffuse lighting within the system.

Il modulo lineare Ben permette l'impiego di una linea di luce diffusa all'interno del sistema.

Das lineare Modul Ben ermöglicht die Verwendung einer Lichtlinie, die sich im System verteilt.

Le module linéaire Ben permet l'emploi d'une ligne de lumière diffuse à l'intérieur du système.

El módulo lineal Ben permite utilizar una línea de luz difusa en el interior del sistema.

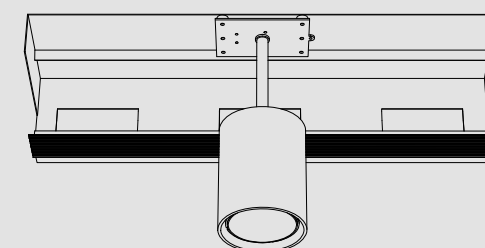

PRINCE 72 EXTERNAL PROJECTOR MODULE

The Prince module provides a fully orientable spotlight that extends out of the system.

Il modulo Prince permette di avere un proiettore completamente orientabile che esce dal sistema.

Das Modul Prince macht es möglich, eine komplett ausrichtbare Leuchte zu erhalten, die das System verlässt.

Le module Prince permet d'avoir un projecteur complètement orientable qui sort du système.

El módulo Prince permite tener un proyector completamente orientable que sobresale del sistema.

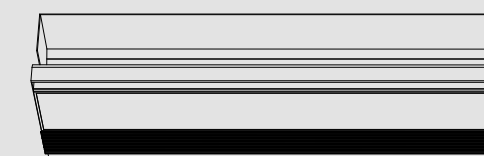

BEN 72 DIFFUSED LIGHT MODULE

The Ben linear module provides a line of diffuse lighting within the system.

Il modulo lineare Ben permette l'impiego di una linea di luce diffusa all'interno del sistema.

Das lineare Modul Ben ermöglicht die Verwendung einer Lichtlinie, die sich im System verteilt.

Le module linéaire Ben permet l'emploi d'une ligne de lumière diffuse à l'intérieur du système.

El módulo lineal Ben permite utilizar una línea de luz difusa en el interior del sistema.

LEONARD 36

design: Lapo Grassellini

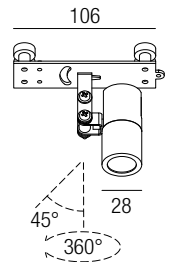

Supply current
 Alimentazione
 Courant d'alimentation
 Stromversorgung
 Corriente de alimentación
250 mA (V_i 18V)

Power
 Potenza
 Pouissance
 Bestuekung
 Potencia
5 W



Photometric diagrams

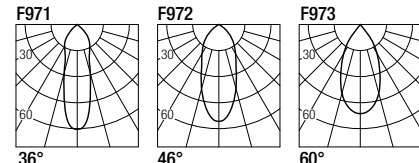

CCT/CRI/Flux	CRI85	CRI93
2700K	445 lm	420 lm
3000K	500 lm	465 lm
4000K	520 lm	480 lm

CRI85 - CRI93
 2-Step MacAdam

Code

Codice - Produkt-Code
 Código de producto

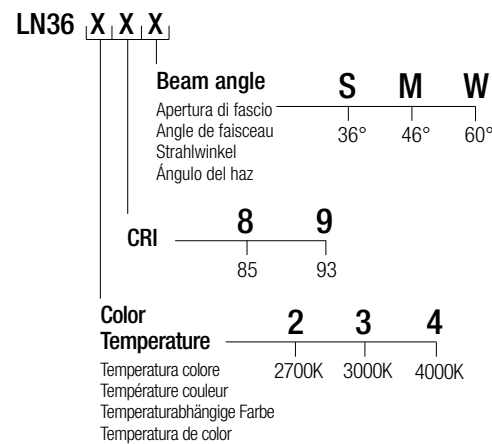

- DATASHEET ▶
- INSTALLATION MANUAL ▶
- CERTIFICATIONS ▶
- LDT-IES ▶
- DRAWINGS ▶

PRINCE 36

design: Lapo Grassellini

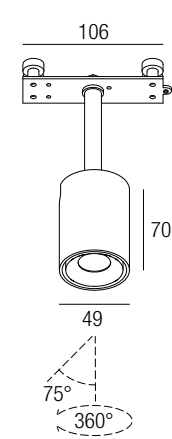

Supply current
 Alimentazione
 Courant d'alimentation
 Stromversorgung
 Corriente de alimentación
250 mA (V_i 36V)

Power
 Potenza
 Pouissance
 Bestuekung
 Potencia
10 W



Photometric diagrams

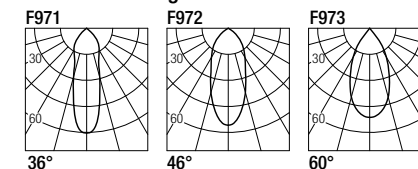

CCT/CRI/Flux	CRI85	CRI93
2700K	890 lm	840 lm
3000K	1000 lm	930 lm
4000K	1040 lm	960 lm

CRI85 - CRI93
 2-Step MacAdam

Code

Codice - Produkt-Code
 Código de producto

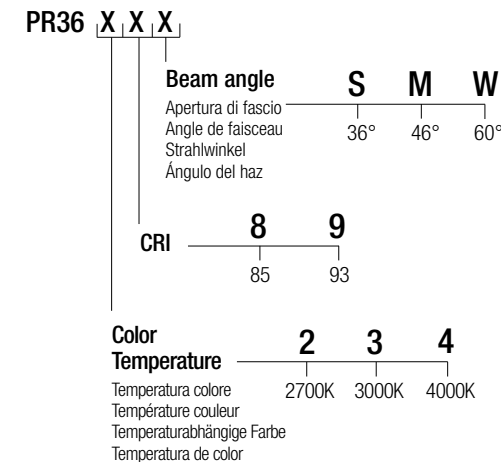

- DATASHEET ▶
- INSTALLATION MANUAL ▶
- CERTIFICATIONS ▶
- LDT-IES ▶
- DRAWINGS ▶

Drivers

Alimentatori - Alimentateurs
 Netzteile - Alimentadores

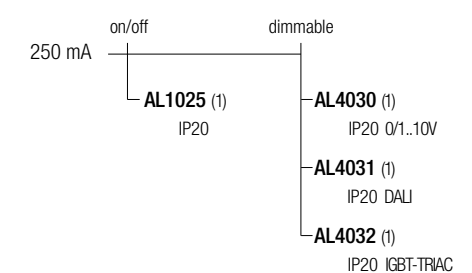

DAVID 36

design: Lapo Grassellini

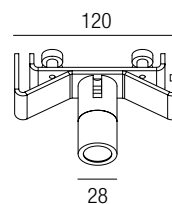

Supply current
 Alimentazione
 Courant d'alimentation
 Stromversorgung
 Corriente de alimentación
250 mA (V_i 36V)

Power
 Potenza
 Pouissance
 Bestuekung
 Potencia
10 W



Photometric diagrams

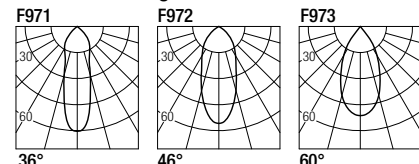

CCT/CRI/Flux	CRI85	CRI93
2700K	890 lm	840 lm
3000K	1000 lm	930 lm
4000K	1040 lm	960 lm

CRI85 - CRI93
 2-Step MacAdam

Code

Codice - Produkt-Code
 Código de producto

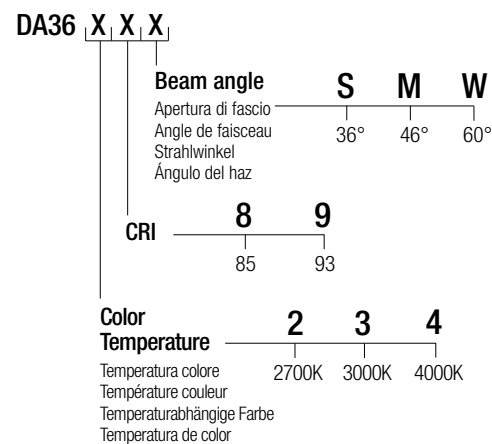

- DATASHEET ▶
- INSTALLATION MANUAL ▶
- CERTIFICATIONS ▶
- LDT-IES ▶
- DRAWINGS ▶

BEN 36

design: Lapo Grassellini

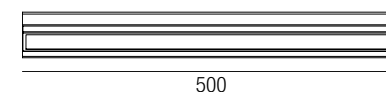

Photometric diagrams

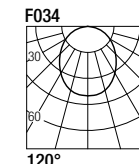

Supply current
 Alimentazione
 Courant d'alimentation
 Stromversorgung
 Corriente de alimentación
24 VDC

Power
 Potenza
 Pouissance
 Bestuekung
 Potencia
15 W



Code

Codice - Produkt-Code
 Código de producto

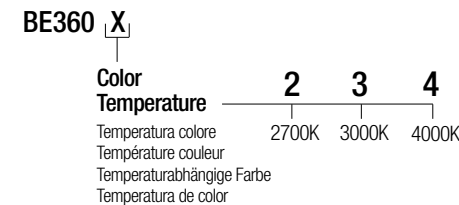

- DATASHEET ▶
- INSTALLATION MANUAL ▶
- CERTIFICATIONS ▶
- LDT-IES ▶
- DRAWINGS ▶

Drivers

Alimentatori - Alimentateurs
 Netzteile - Alimentadores

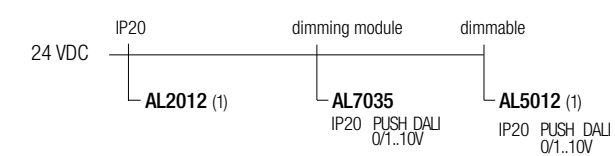

Note: dimming module AL7035 to be used in combination with a 24VDC power supply - **Nota:** modulo di dimmerazione AL7035 da utilizzare in combinazione con un alimentatore 24VDC - **Note:** module de variation AL7035 d'intensité à utiliser en combinaison avec une alimentation 24VDC - **Anmerkung:** Dimmmodul AL7035 zur Verwendung in Kombination mit einem 24VDC-Netzteil - **Nota:** módulo de regulación AL7035 se utiliza en combinación con una fuente de alimentación 24VDC

LEONARD 72

design: Lapo Grassellini

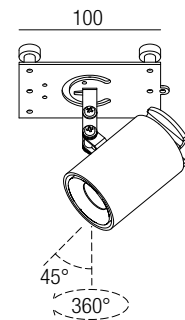

Supply current
Alimentazione
Courant d'alimentation
Stromversorgung
Corriente de alimentación
250 mA (V, 36V)

Power
Potenza
Puissance
Bestuekung
Potencia
10 W



Photometric diagrams

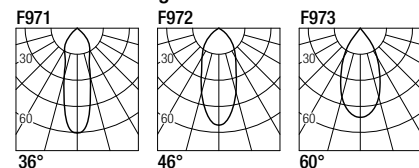

CCT/CRI/Flux

CCT	CRI85	CRI93
2700K	890 lm	840 lm
3000K	1000 lm	930 lm
4000K	1040 lm	960 lm

CRI85 - CRI93
2-Step MacAdam

Code

Codice - Produkt-Code
Código de producto

LN72 X X X

Beam angle
Apertura di fascio
Angle de faisceau
Strahlwinkel
Ángulo del haz

S	M	W
36°	46°	60°

CRI

8	9
85	93

Color Temperature
Temperatura colore
Température couleur
Temperaturabhängige Farbe
Temperatura de color

2	3	4
2700K	3000K	4000K

[DATASHEET](#) [INSTALLATION MANUAL](#)

[CERTIFICATIONS](#) [LDT-IES](#) [DRAWINGS](#)

PRINCE 72

design: Lapo Grassellini

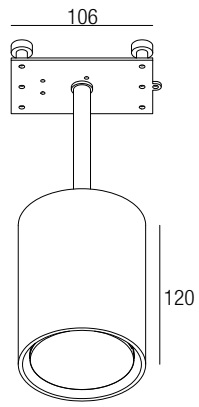

Supply current
Alimentazione
Courant d'alimentation
Stromversorgung
Corriente de alimentación
500 mA (V, 36V)

Power
Potenza
Puissance
Bestuekung
Potencia
20 W

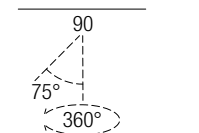

Photometric diagrams

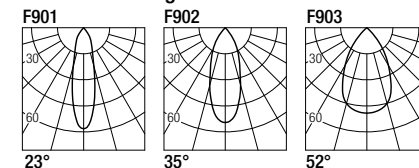

CCT/CRI/Flux

CCT	CRI85	CRI93
2700K	1830 lm	1700 lm
3000K	2000 lm	1830 lm
4000K	2100 lm	1950 lm

CRI85 - CRI93
2-Step MacAdam

Code

Codice - Produkt-Code
Código de producto

PR72 X X X

Beam angle
Apertura di fascio
Angle de faisceau
Strahlwinkel
Ángulo del haz

S	M	W
23°	35°	52°

CRI

8	9
85	93

Color Temperature
Temperatura colore
Température couleur
Temperaturabhängige Farbe
Temperatura de color

2	3	4
2700K	3000K	4000K

[DATASHEET](#) [INSTALLATION MANUAL](#)

[CERTIFICATIONS](#) [LDT-IES](#) [DRAWINGS](#)

Drivers

Alimentatori - Alimentateurs
Netzteile - Alimentadores

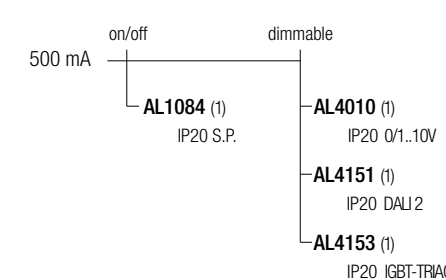

DAVID 72

design: Lapo Grassellini

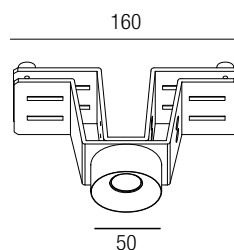

Supply current
Alimentazione
Courant d'alimentation
Stromversorgung
Corriente de alimentación
500 mA (V, 36V)

Power
Potenza
Puissance
Bestuekung
Potencia
20 W



Photometric diagrams

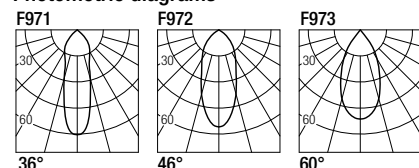

CCT/CRI/Flux

CCT	CRI85	CRI93
2700K	1830 lm	1700 lm
3000K	2000 lm	1830 lm
4000K	2100 lm	1950 lm

CRI85 - CRI93
2-Step MacAdam

Code

Codice - Produkt-Code
Código de producto

DA72 X X X

Beam angle
Apertura di fascio
Angle de faisceau
Strahlwinkel
Ángulo del haz

S	M	W
36°	46°	60°

CRI

8	9
85	93

Color Temperature
Temperatura colore
Température couleur
Temperaturabhängige Farbe
Temperatura de color

2	3	4
2700K	3000K	4000K

[DATASHEET](#) [INSTALLATION MANUAL](#)

[CERTIFICATIONS](#) [LDT-IES](#) [DRAWINGS](#)

Drivers

Alimentatori - Alimentateurs
Netzteile - Alimentadores

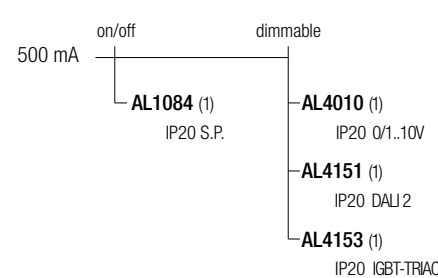

BEN 72

design: Lapo Grassellini



Photometric diagrams

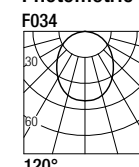

Supply current
Alimentazione
Courant d'alimentation
Stromversorgung
Corriente de alimentación
24 VDC

Power
Potenza
Puissance
Bestuekung
Potencia
30 W

Code

Codice - Produkt-Code
Código de producto

BE720 X

Color Temperature
Temperatura colore
Température couleur
Temperaturabhängige Farbe
Temperatura de color

2	3	4
2700K	3000K	4000K

[DATASHEET](#) [INSTALLATION MANUAL](#)

[CERTIFICATIONS](#) [LDT-IES](#) [DRAWINGS](#)

Drivers

Alimentatori - Alimentateurs
Netzteile - Alimentadores

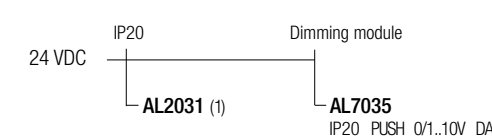

Note: dimming module AL7035 to be used in combination with a 24VDC power supply - **Nota:** modulo di dimmerazione AL7035 da utilizzare in combinazione con un alimentatore 24VDC - **Note:** module de variation AL7035 d'intensité à utiliser en combinaison avec une alimentation 24VDC - **Anmerkung:** Dimmmodul AL7035 zur Verwendung in Kombination mit einem 24VDC-Netzteil - **Nota:** módulo de regulación AL7035 se utiliza en combinación con una fuente de alimentación 24VDC



OCTO Ceiling

A 24VDC multifunctional modular system for ceiling installation. The combination of linear elements and various joints permits the creation of complex geometries meaning that, thanks to the available light modules, it can meet any illumination need.

Sistema multifunzionale componibile a 24VDC per installazione a plafone. Combinando elementi lineari e vari giunti permette la realizzazione di geometrie complesse, e grazie ai moduli luminosi disponibili può rispondere a qualsiasi necessità luminosa.

Système multifonction modulaire en 24VDC pour installation sur plafond. Combinant des éléments linaires et diverses jonctions, il permet de réaliser des géométries complexes et, grâce aux modules lumineux disponibles, il peut répondre à toute exigence lumineuse.

Multifunktionales modulares 24VDC-System für die Deckenmontage. Die Kombination von linearen Elementen und verschiedenen Verbindungen ermöglicht die Realisierung komplexer Geometrien und kann dank der verfügbaren Lichtmodule auf jeden Lichtbedarf reagieren.

Sistema modular multifuncional de 24VDC para la instalación en el techo. La combinación de los elementos lineales y las diferentes juntas permite la realización de geometrías complejas y, gracias a los módulos luminosos disponibles, puede responder a cualquier necesidad de iluminación.



Structure
Struttura - Structure
Struktur - Estructura

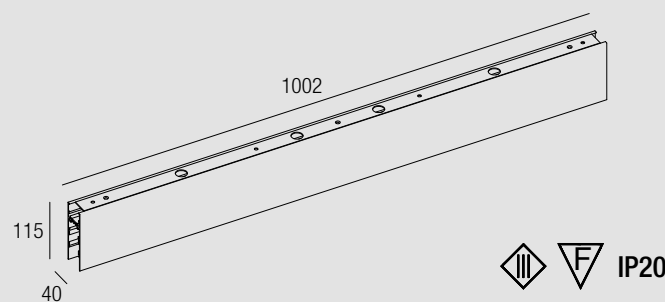

Straight module 1002 mm
Modulo lineare 1002 mm
Module droit 1002 mm
Gerades Modul 1002 mm
Módulo recto 1002 mm

Power supply
Alimentazione
Alimentation
Stromversorgung
Alimentación
24 VDC

Max current
Corrente massima
Courant max
Maximaler Strom
Corriente máxima
15 A

Code
Codice - Produkt-Code
Código de producto

CTC-ST X X

	1	2	3
Structure	Empty	With track	With track and power supply
Struttura	Vuota	Con binario	Con binario ed alimentazione
Structure	Vide	Avec piste	Avec rail et alimentation
Struktur	Leere	Mit Track	Mit Track und Netzteil
Estructura	Vacía	Con pista	Con pista y alimentación
Finishing	White	Black	
Finitura	Bianco	Nero	
Finitions	Blanc	Noir	
Oberflächenfinish	Weiß	Schwarz	
Acabados	Blanco	Negro	

Drivers
Alimentatori - Alimentateurs
Netzteile - Alimentadores

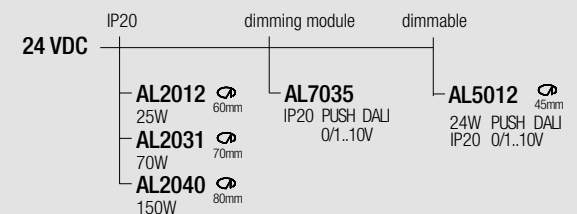

Note: dimming module AL7035 to be used in combination with a 24VDC power supply - **Nota:** modulo di dimmerazione AL7035 da utilizzare in combinazione con un alimentatore 24VDC - **Note:** module de variation AL7035 d'intensité à utiliser en combinaison avec une alimentation 24VDC - **Anmerkung:** Dimmmodul AL7035 zur Verwendung in Kombination mit einem 24VDC-Netzteil - **Nota:** módulo de regulación AL7035 se utiliza en combinación con una fuente de alimentación 24VDC

Load scheme
Schema di carico - Schéma de charge
Lastannahmen - Esquema de carga

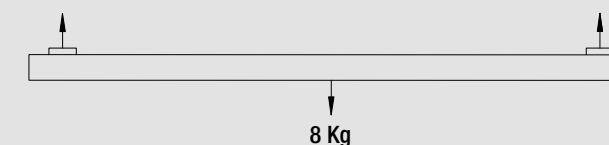

Joints
Giunti - Conjuntas

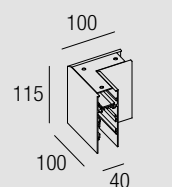

L-joint
Giunto L
Joint L
Conjunta L

CTC-L01B White - Bianco - Blanc
Weiß - Blanco

CTC-L01N Black - Nero - Noir
Schwarz - Negro

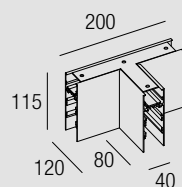

T-joint
Giunto T
Joint T
Conjunta T

CTC-T01B White - Bianco - Blanc
Weiß - Blanco

CTC-T01N Black - Nero - Noir
Schwarz - Negro

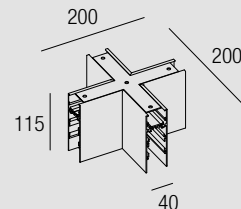

X-joint
Giunto X
Joint X
Conjunta X

CTC-X01B White - Bianco - Blanc
Weiß - Blanco

CTC-X01N Black - Nero - Noir
Schwarz - Negro

Accessories
Accessori - Accessoires
Zubehör - Accesorios



Dead end
Chiusura
Bouchon
Endkappe
Tapa

CT-DEB White - Bianco - Blanc
Weiß - Blanco

CT-DEN Black - Nero - Noir
Schwarz - Negro



Mechanical joints (2 pcs)
Giunti meccanici
Joints mécaniques
Mechanische Verbindungen
Juntas mecánicas



Electrical straight joint
Giunto elettrico
Joint électrique
Elektrische Verbindung
Junta electrica

CT-MJB White - Bianco - Blanc
Weiß - Blanco

CT-MJN Black - Nero - Noir
Schwarz - Negro

CT-EJ

Modules
Accessori - Accessoires
Zubehör - Accesorios

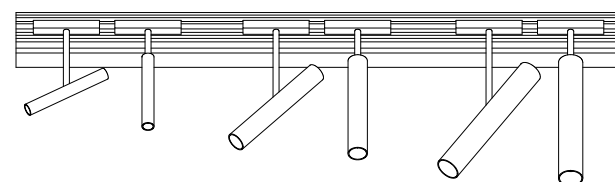

JOS X
ADJUSTABLE PROJECTOR

A projector module characterised by a minimal design and high optical performance. Also available in a version with 10°-55° adjustable lens.

Modulo proiettore connotato da un design minimale ed elevate prestazioni ottiche. Disponibile anche in versione ad ottica regolabile 10°-55°.

Projektormodul, das sich durch ein minimalistisches Design und hohe optische Leistung auszeichnet. Reichen Auch in der Version mit 10°-55° verstellbarer Optik erhältlich.

Module projecteur à design minimaliste et hautes performances optiques. Disponible aussi en version à optique réglable 10°-55°.

Módulo proyector caracterizado por un diseño minimalista y un alto rendimiento óptico. También disponible en versión de óptica ajustable de 10°-55°.

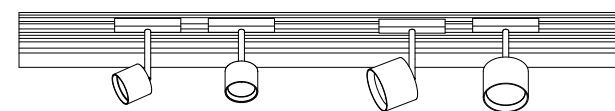

LAD X
ADJUSTABLE PROJECTOR

A projector module characterised by a minimal design and high optical performance. Thanks to the use of highly-advanced optics, it offers narrow and precise light beams.

Modulo proiettore connotato da un design minimale ed elevate prestazioni ottiche. Grazie all'utilizzo di ottiche estremamente evolute permette fasci luminosi stretti e precisi.

Projektormodul, das sich durch ein minimalistisches Design und hohe optische Leistung auszeichnet. Dank der Verwendung extrem fortschrittlicher Optiken ermöglicht es schmale und präzise Lichtstrahlen.

Module projecteur à design minimaliste et hautes performances optiques. L'utilisation d'optique extrêmement évoluées permet d'obtenir des faisceaux étroits et précis.

Módulo proyector caracterizado por un diseño minimalista y un alto rendimiento óptico. Gracias a la utilización de ópticas extremadamente avanzadas permite haces de luz estrechos y precisos.

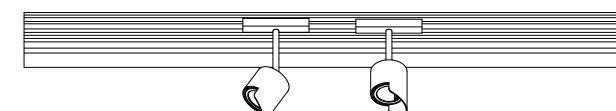

LAD X WALL WASHER
ADJUSTABLE WALL WASHER PROJECTOR

A projector module characterised by a minimal design and extremely precise and clean wall washer optics. The geometry of the body eliminates visibility of the light source, ensuring extremely high visual comfort.

Modulo proiettore connotato da un design minimale ed un'ottica wall washer estremamente precisa e pulita. La geometria del corpo annulla la visibilità della sorgente luminosa rendendo il comfort visivo estremamente elevato.

Projektormodul, das sich durch ein minimalistisches Design und hohe Wallwasher-Optik extrem präzise und sauber. Die Geometrie des Körpers hebt die Sichtbarkeit der Lichtquelle auf, wodurch der Sehkomfort extrem hoch ist.

Module projecteur à design minimaliste et avec une optique wallwasher extrêmement précise et nette. La géométrie du corps dissimule la source lumineuse, pour un confort visuel extrêmement élevé.

Módulo proyector caracterizado por un diseño minimalista y una óptica wall washer muy precisa y limpia. La geometría del cuerpo anula la visibilidad de la fuente luminosa haciendo que el confort visual sea extremadamente alto.



LEV X
LINEAR MODULE

A linear module available in two wattages, it combines luminous efficiency and extremely precise optics for general and accent lighting applications.

Modulo lineare disponibile in due wattaggi, che combina efficienza luminosa ed ottiche estremamente precise, per applicazioni di illuminazione generale e d'accento.

Linearmodul in zwei Wattagen erhältlich, das extrem präzise Lichtausbeute und Optik kombiniert, für Anwendungen in der Allgemein- und Akzentbeleuchtung.

Module linéaire disponible en deux puissances, alliant efficacité lumineuse et optiques d'une extrême précision, pour applications d'éclairage général et d'accentuation.

Módulo lineal disponible en dos potencias, que combina una eficiencia luminosa y óptica extremadamente precisa, para aplicaciones de iluminación general y de acento.

OCTO Pendant

A 24VDC multifunctional modular system for suspension installation. The combination of linear elements and various joints allows the creation of complex geometries meaning that, thanks to the available light modules, it can meet any illumination need. These linear modules can be equipped with elements for indirect light.

Sistema multifunzionale componibile a 24VDC per installazione a sospensione. Combinando elementi lineari e vari giunti permette la realizzazione di geometrie complesse, e grazie ai moduli luminosi disponibili può rispondere a qualsiasi necessità luminosa. I moduli lineari possono essere equipaggiati con elementi per luce indiretta.

Système multifonction modulaire en 24VDC pour installation en suspension. Combinant des éléments linéaires et diverses jonctions, il permet de réaliser des géométries complexes et, grâce aux modules lumineux disponibles, il peut répondre à toute exigence lumineuse. Les modules linéaires peuvent être équipés d'éléments pour éclairage indirect.

Multifunktionales, modulares 24VDC-System für die hängende Installation. Die Kombination von linearen Elementen und verschiedenen Verbindungen ermöglicht die Realisierung komplexer Geometrien und kann dank der verfügbaren Lichtmodule auf jeden Lichtbedarf reagieren. Die linearen Module können mit indirekten Beleuchtungselementen ausgestattet werden.

Sistema modular multifuncional de 24VDC para la instalación de suspensión. La combinación de los elementos lineales y las diferentes juntas permite la realización de geometrías complejas y, gracias a los módulos luminosos disponibles, puede responder a cualquier necesidad de iluminación. Los módulos lineales pueden ser equipados con elementos de iluminación indirecta.



Structure

Struttura - Structure
Struktur - Estructura

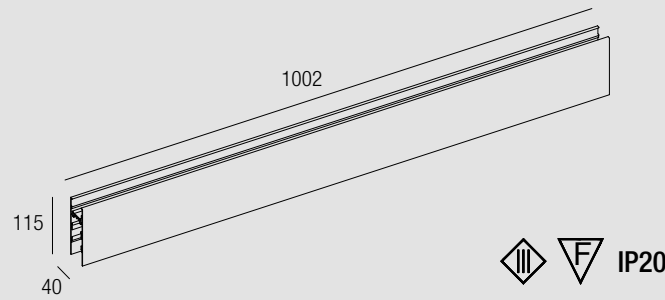

Straight module 1002 mm
Modulo lineare 1002 mm
Module droit 1002 mm
Gerades Modul 1002 mm
Módulo recto 1002 mm

Power supply
Alimentazione
Alimentation
Stromversorgung
Alimentación
24 VDC

Max current
Corrente massima
Courant max
Maximaler Strom
Corriente máxima
15 A

Code

Codice - Produkt-Code
Código de producto

CTP-ST X X X

Indirect light 21 W
Luce indiretta 21W
Lumière indirecte 21W
Indirektes Licht 21W
Luz indirecta 21W

2 2700K 3 3000K 4 4000K N No Non Nein

Structure

1	2	3
Empty Vuota Vide Leere Vacía	With track Con binario Avec piste Mit Track Con pista	With track and power supply Con binario ed alimentazione Avec rail et alimentation Mit Track und Netzteil Con pista y alimentación

Finishing

1	5
White Bianco Blanc Weiß Blanco	Black Nero Noir Schwarz Negro

Joints

Giunti - Conjuntas

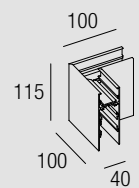

L-joint
Giunto L
Joint L
Conjunta L

CTP-L01B White - Bianco - Blanc
Weiß - Blanco

CTP-L01N Black - Nero - Noir
Schwarz - Negro

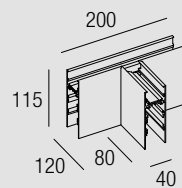

T-joint
Giunto T
Joint T
Conjunta T

CTP-T01B White - Bianco - Blanc
Weiß - Blanco

CTP-T01N Black - Nero - Noir
Schwarz - Negro

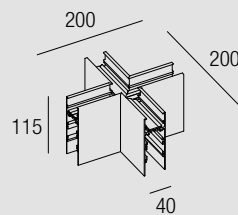

X-joint
Giunto X
Joint X
Conjunta X

CTP-X01B White - Bianco - Blanc
Weiß - Blanco

CTP-X01N Black - Nero - Noir
Schwarz - Negro

Modules

Accessori - Accessoires
Zubehör - Accesorios

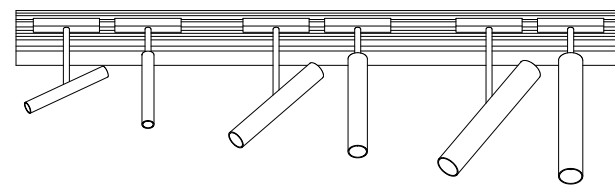

JOS X
ADJUSTABLE PROJECTOR

A projector module characterised by a minimal design and high optical performance. Also available in a version with 10°-55° adjustable lens.

Modulo proiettore connotato da un design minimale ed elevate prestazioni ottiche. Disponibile anche in versione ad ottica regolabile 10°-55°.

Projektormodul, das sich durch ein minimalistisches Design und hohe optische Leistung auszeichnet. Reichen Auch in der Version mit 10°-55° verstellbarer Optik erhältlich.

Module projecteur à design minimaliste et hautes performances optiques. Disponible aussi en version à optique réglable 10°-55°.

Módulo proyector caracterizado por un diseño minimalista y un alto rendimiento óptico. También disponible en versión de óptica ajustable de 10°-55°.

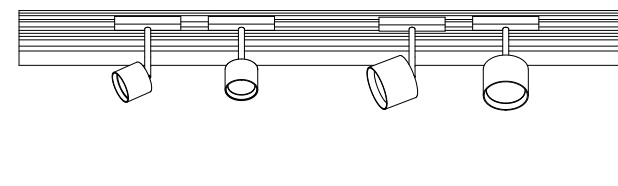

LAD X
ADJUSTABLE PROJECTOR

A projector module characterised by a minimal design and high optical performance. Thanks to the use of highly-advanced optics, it offers narrow and precise light beams.

Modulo proiettore connotato da un design minimale ed elevate prestazioni ottiche. Grazie all'utilizzo di ottiche estremamente evolute permette fasci luminosi stretti e precisi.

Projektormodul, das sich durch ein minimalistisches Design und hohe optische Leistung auszeichnet. Dank der Verwendung extrem fortschrittlicher Optiken ermöglicht es schmale und präzise Lichtstrahlen.

Module projecteur à design minimaliste et hautes performances optiques. L'utilisation d'optique extrêmement évoluées permet d'obtenir des faisceaux étroits et précis.

Módulo proyector caracterizado por un diseño minimalista y un alto rendimiento óptico. Gracias a la utilización de ópticas extremadamente avanzadas permite haces de luz estrechos y precisos.

Accessories

Accessori - Accessoires
Zubehör - Accesorios



Dead end
Chiusura
Bouchon
Endkappe
Tapa

CT-DEB White - Bianco - Blanc
Weiß - Blanco

CT-DEN Black - Nero - Noir
Schwarz - Negro



Mechanical joints (2 pcs)
Giunti meccanici
Joins mécaniques
Mechanische Verbindungen
Juntas mecánicas

CT-MJB White - Bianco - Blanc
Weiß - Blanco

CT-MJN Black - Nero - Noir
Schwarz - Negro



Electrical straight joint
Giunto elettrico
Joint électrique
Elektrische Verbindung
Junta electrica

CT-EJ



Suspension kit with steel wire and automatic locking device
Kit di sospensione con cavo d'acciaio e bloccacavo automatico - Kit de suspension avec fil d'acier et verrouillage automatique - Fahrwerk mit Stahldraht und automatischer Verriegelung - Kit de suspensión con alambre de acero y bloqueo automático

CTP-K01

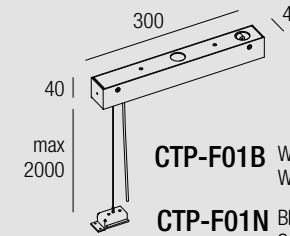

Ceiling rose without driver and with suspension kit CTP-K01
Rosone senza alimentatore e con kit di sospensione CTP-K01 - Rosace de plafond sans alimentation et avec kit de suspension CTP-K01 - Deckenrosette ohne Netzteil und mit Aufhänageset CTP-K01 - Rosetón sin alimentación y con kit de suspensión CTP-K01

CTP-F01B White - Bianco - Blanc
Weiß - Blanco

CTP-F01N Black - Nero - Noir
Schwarz - Negro

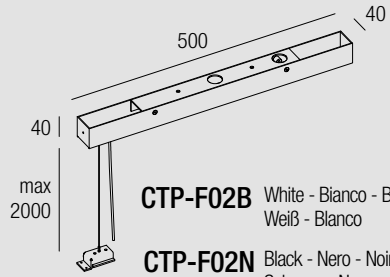

Ceiling rose with driver 100 W and suspension kit CTP-K01
Rosone con alimentatore 100 W e kit di sospensione CTP-K01 - Rosace de plafond avec alimentation 100 W et kit de suspension CTP-K01 - Deckenrosette mit Netzteil 100 W und Aufhänageset CTP-K01 - Rosetón con alimentación 100 W y kit de suspensión CTP-K01

CTP-F02B White - Bianco - Blanc
Weiß - Blanco

CTP-F02N Black - Nero - Noir
Schwarz - Negro

Drivers

Alimentatori - Alimentateurs
Netzteile - Alimentadores

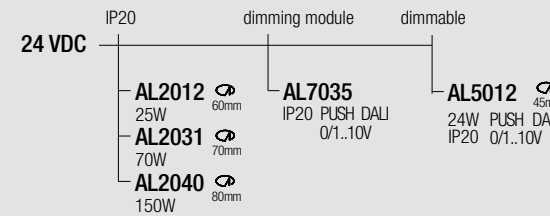

Note: dimming module AL7035 to be used in combination with a 24VDC power supply - **Nota:** modulo di dimmerazione AL7035 da utilizzare in combinazione con un alimentatore 24VDC - **Note:** module de variation AL7035 d'intensité à utiliser en combinaison avec une alimentation 24VDC **Anmerkung:** Dimmmodul AL7035 zur Verwendung in Kombination mit einem 24VDC-Netzteil - **Nota:** módulo de regulación AL7035 se utiliza en combinación con una fuente de alimentación 24VDC

Load scheme

Schema di carico - Schéma de charge
Lastannahmen - Esquema de carga

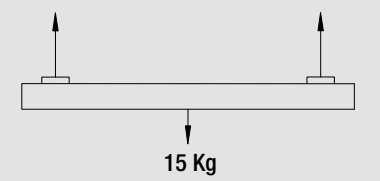

JOS X2

design: Roberto Mantovani

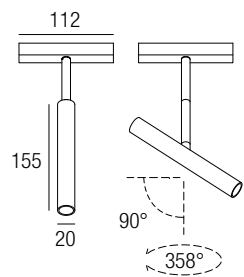

Supply current

Alimentazione
Courant d'alimentation
Stromversorgung
Corriente de alimentación

24 VDC

Power

Potenza
Puissance
Bestuekung
Potencia

2 W



CCT/CRI/Flux

2700K — 128 lm
3000K — 133 lm
4200K — 154 lm

Photometric diagrams

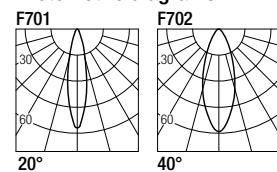

CRI85

2-Step MacAdam

Code Construction

Costruzione del codice - Construction du code produit
Bau der Produkt-Code - Construcción del código de producto

JSX2 | X | X | X |

Beam angle	1	2	
Apertura di fascio	20°	40°	
Angle de faisceau			
Strahlwinkel			
Ángulo del haz			
Color Temperature	2	3	4
Temperatura colore	2700K	3000K	4200K
Température couleur			
Temperaturabhängige Farbe			
Temperatura de color			
Finishing	1	5	
Finitura	White	Black	
Finitions	Bianco	Nero	
Oberflächenfinish	Blanc	Noir	
Acabados	Weiß	Schwarz	
	Blanco	Negro	

Note: versions with extended arm length are available upon request
Nota: versioni con lunghezza del braccetto maggiorata disponibili su richiesta
Note: versions avec longueur du bras majorée disponibles sur demande
Anmerkung: versionen mit erhöhter Armlänge auf Anfrage erhältlich
Nota: Versiones con longitud del brazo aumentada disponible bajo pedido

JOS X6

design: Roberto Mantovani

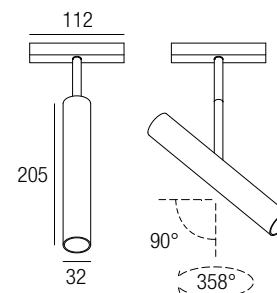

Supply current

Alimentazione
Courant d'alimentation
Stromversorgung
Corriente de alimentación

24 VDC

Power

Potenza
Puissance
Bestuekung
Potencia

6 W



CCT/CRI/Flux

2700K — 540 lm
3000K — 600 lm
4000K — 620 lm

Photometric diagrams

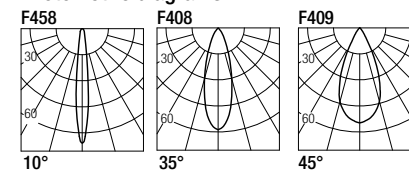

CRI98

2-Step MacAdam

Code Construction

Costruzione del codice - Construction du code produit
Bau der Produkt-Code - Construcción del código de producto

JSX6 | X | X | X |

Beam angle	0	1	2
Apertura di fascio	10°	35°	45°
Angle de faisceau			
Strahlwinkel			
Ángulo del haz			
Color Temperature	2	3	4
Temperatura colore	2700K	3000K	4000K
Température couleur			
Temperaturabhängige Farbe			
Temperatura de color			
Finishing	1	5	
Finitura	White	Black	
Finitions	Bianco	Nero	
Oberflächenfinish	Blanc	Noir	
Acabados	Weiß	Schwarz	
	Blanco	Negro	

Note: versions with extended arm length are available upon request
Nota: versioni con lunghezza del braccetto maggiorata disponibili su richiesta
Note: versions avec longueur du bras majorée disponibles sur demande
Anmerkung: versionen mit erhöhter Armlänge auf Anfrage erhältlich
Nota: Versiones con longitud del brazo aumentada disponible bajo pedido

Accessories

Accessori - Accessoires
Zubehör - Accesorios

LJ02 White Bianco Blanc Weiß Blanco	LJ02B Black Nero Noir Schwarz Negro	SJ02 White Bianco Blanc Weiß Blanco	SJ02B Black Nero Noir Schwarz Negro
Low luminance louver Filtro antiabbagliamento Filtre basse luminance Geringe Leuchtdichte-Filter Filtro de baja luminancia		Milky screen Schermo opale Écran opale Opal-Bildschirm Pantalla opal	

JOS X10

design: Roberto Mantovani

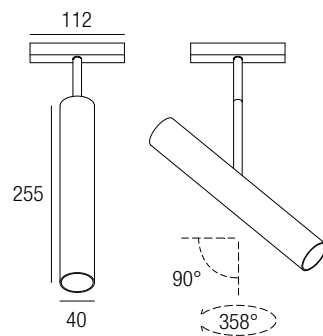

Supply current
Alimentazione
Courant d'alimentation
Stromversorgung
Corriente de alimentación
24 VDC

Power
Potenza
Puissance
Bestuekung
Potencia
10 W



Photometric diagrams

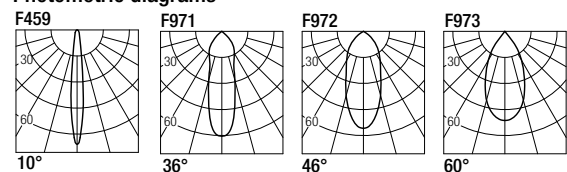

CCT/CRI/Flux	CRI85	CRI93
2700K	890 lm	840 lm
3000K	1000 lm	930 lm
4000K	1040 lm	960 lm

CRI85 - CRI93
2-Step MacAdam

Code Construction

Costruzione del codice - Construction du code produit
Bau der Produkt-Code - Construcción del código de producto

JSX1 X X X X

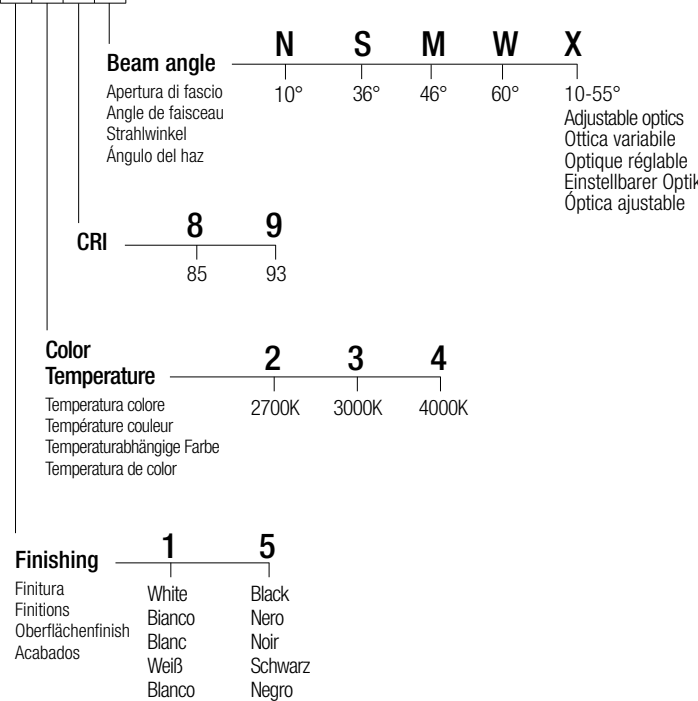

Note: versions with extended arm length are available upon request
Nota: versioni con lunghezza del braccetto maggiorata disponibili su richiesta
Note: versions avec longueur du bras majorée disponibles sur demande
Anmerkung: versionen mit erhöhter Armlänge auf Anfrage erhältlich
Nota: Versiones con longitud del brazo aumentada disponible bajo pedido



LAD X6

design: Roberto Mantovani

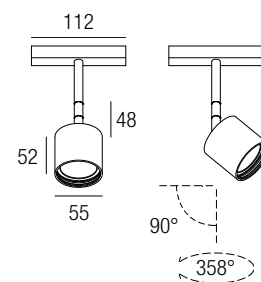

Supply current
Alimentazione
Courant d'alimentation
Stromversorgung
Corriente de alimentación
24 VDC

Power
Potenza
Puissance
Bestuekung
Potencia
6 W



Photometric diagrams

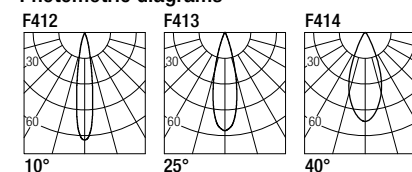

CCT/CRI/Flux	CRI85	CRI93
2700K	540 lm	
3000K	600 lm	
4000K	620 lm	

CRI98
2-Step MacAdam

Code Construction

Costruzione del codice - Construction du code produit
Bau der Produkt-Code - Construcción del código de producto

LADX6 X X X

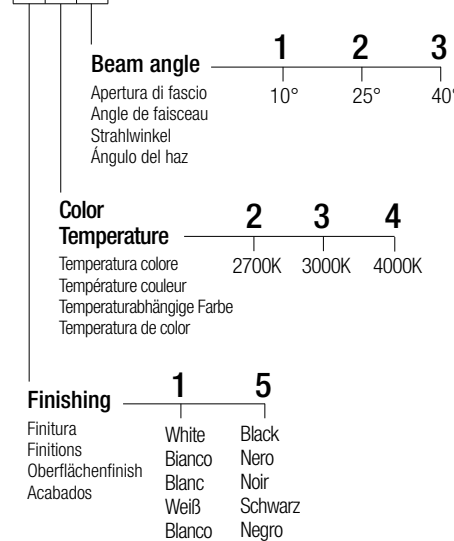

Note: versions with extended arm length are available upon request
Nota: versioni con lunghezza del braccetto maggiorata disponibili su richiesta
Note: versions avec longueur du bras majorée disponibles sur demande
Anmerkung: versionen mit erhöhter Armlänge auf Anfrage erhältlich
Nota: Versiones con longitud del brazo aumentada disponible bajo pedido



Accessories

Accessori - Accessoires
Zubehör - Accesorios

LJ01	LJ01B	SJ01	SJ01B
White Bianco Blanc Weiß Blanco	Black Nero Noir Schwarz Negro	White Bianco Blanc Weiß Blanco	Black Nero Noir Schwarz Negro
Low luminance louver Filtro antiabbagliamento Filtre basse luminance Geringe Leuchtdichte-Filter Filtro de baja luminancia	Milky screen Schermo opale Écran opale Opal-Bildschirm Pantalla opal		

Note: the filter and the screen are not available in adjustable optics version 10-55° - **Nota:** il filtro e lo schermo non sono disponibili nella versione ad ottica regolabile 10-55° - **Note:** le filtre et l'écran ne sont pas disponibles dans la version à optique réglable 10-55° - **Anmerkung:** Filter und Bildschirm sind in der einstellbaren optischen Version 10-55° nicht verfügbar - **Nota:** el filtro y la pantalla no están disponibles en la versión de óptica ajustable 10-55°

Accessories

Accessori - Accessoires
Zubehör - Accesorios

LL02	LL02B	SL02	SL02B
White Bianco Blanc Weiß Blanco	Black Nero Noir Schwarz Negro	White Bianco Blanc Weiß Blanco	Black Nero Noir Schwarz Negro
Low luminance louver Filtro antiabbagliamento Filtre basse luminance Geringe Leuchtdichte-Filter Filtro de baja luminancia	Milky screen Schermo opale Écran opale Opal-Bildschirm Pantalla opal		

LAD X10

design: Roberto Mantovani

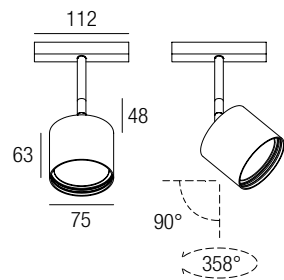

Supply current

Alimentazione
Courant d'alimentation
Stromversorgung
Corriente de alimentación

24 VDC

Power

Potenza
Puissance
Bestuekung
Potencia

10 W



Photometric diagrams

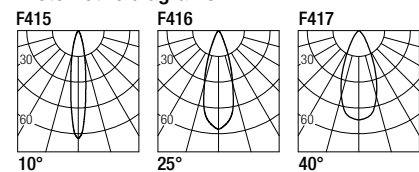

CCT/CRI/Flux

	CRI85	CRI93
2700K	890 lm	840 lm
3000K	1000 lm	930 lm
4000K	1040 lm	960 lm

CRI85 - CRI93

2-Step MacAdam

Code Construction

Costruzione del codice - Construction du code produit
Bau der Produkt-Code - Construcción del código de producto

LADX1 X X X X

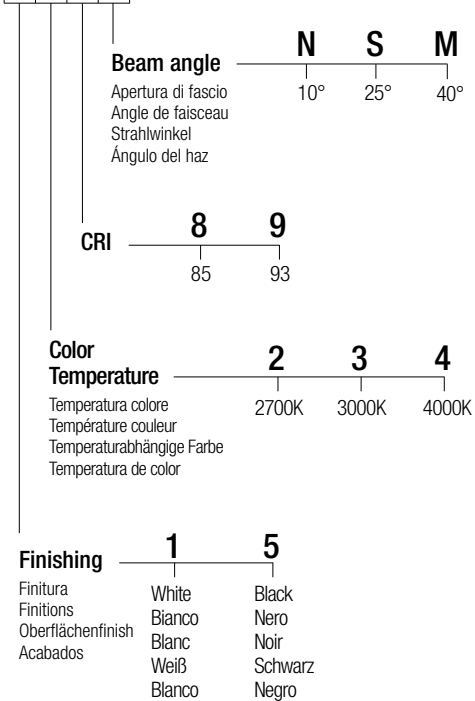

Note: versions with extended arm length are available upon request
Nota: versioni con lunghezza del braccetto maggiorata disponibili su richiesta
Note: versions avec longueur du bras majorée disponibles sur demande
Anmerkung: versionen mit erhöhter Armlänge auf Anfrage erhältlich
Nota: Versiones con longitud del brazo aumentada disponible bajo pedido

[DATASHEET](#) [INSTALLATION MANUAL](#)

[CERTIFICATIONS](#) [LDT-IES](#) [DRAWINGS](#)



LAD X10 WALL WASHER

design: Roberto Mantovani

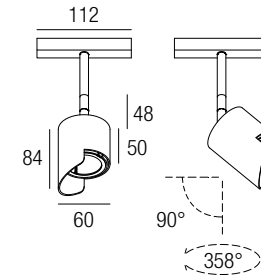

Supply current

Alimentazione
Courant d'alimentation
Stromversorgung
Corriente de alimentación

24 VDC

Power

Potenza
Puissance
Bestuekung
Potencia

10 W



Photometric diagrams

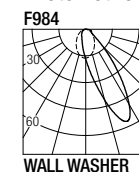

CCT/CRI/Flux

	CRI85	CRI93
2700K	890 lm	840 lm
3000K	1000 lm	930 lm
4000K	1040 lm	960 lm

CRI85 - CRI93

2-Step MacAdam

Code Construction

Costruzione del codice - Construction du code produit
Bau der Produkt-Code - Construcción del código de producto

LADXW X X X

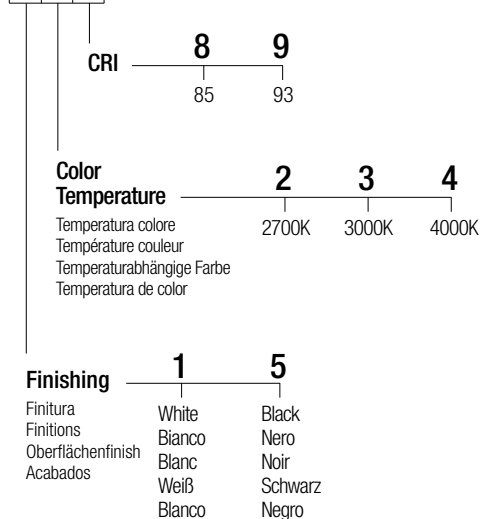

Note: versions with extended arm length are available upon request
Nota: versioni con lunghezza del braccetto maggiorata disponibili su richiesta
Note: versions avec longueur du bras majorée disponibles sur demande
Anmerkung: versionen mit erhöhter Armlänge auf Anfrage erhältlich
Nota: Versiones con longitud del brazo aumentada disponible bajo pedido

[DATASHEET](#) [INSTALLATION MANUAL](#)

[CERTIFICATIONS](#) [LDT-IES](#) [DRAWINGS](#)



LEV X7

design: Roberto Mantovani

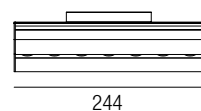

Supply current
 Alimentazione
 Courant d'alimentation
 Stromversorgung
 Corriente de alimentación
24 VDC

Power
 Potenza
 Pouissance
 Bestuekung
 Potencia
7 W



CCT/CRI/Flux

2700K — 623 lm
 3000K — 651 lm
 4200K — 721 lm

Photometric diagrams

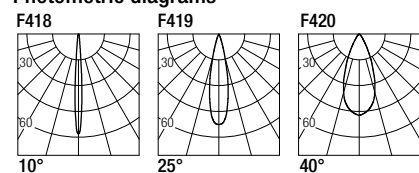

CRI85
 2-Step MacAdam

Code Construction

Costruzione del codice - Construction du code produit
 Bau der Produkt-Code - Construcción del código de producto

LVX1 X X X

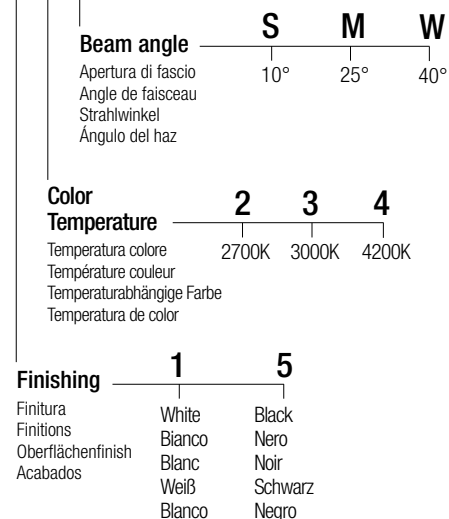

[DATASHEET ▶](#) [INSTALLATION MANUAL ▶](#)

[CERTIFICATIONS ▶](#) [LDT-IES ▶](#) [DRAWINGS ▶](#)



[DATASHEET ▶](#) [INSTALLATION MANUAL ▶](#)

[CERTIFICATIONS ▶](#) [LDT-IES ▶](#) [DRAWINGS ▶](#)

LEV X14

design: Roberto Mantovani

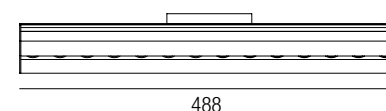

Supply current
 Alimentazione
 Courant d'alimentation
 Stromversorgung
 Corriente de alimentación
24 VDC

Power
 Potenza
 Pouissance
 Bestuekung
 Potencia
14 W



CCT/CRI/Flux

2700K — 1246 lm
 3000K — 1302 lm
 4200K — 1442 lm

Photometric diagrams

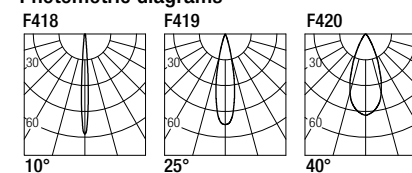

CRI85
 2-Step MacAdam

Code Construction

Costruzione del codice - Construction du code produit
 Bau der Produkt-Code - Construcción del código de producto

LVX2 X X X

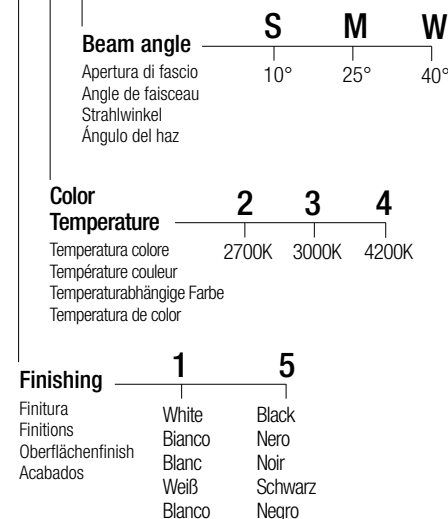

ARIK 2

design: Roberto Mantovani

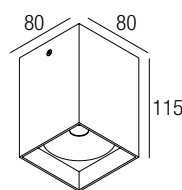

Supply current

Alimentazione
Courant d'alimentation
Stromversorgung
Corriente de alimentación
350-500 mA (V, 2,9V) (CC)
230 VAC (AC)

Power

Potenza
Puissance
Bestuekung
Potencia
1-2 W

Series wiring (CC)

Cablaggio in serie
Câblage en série
Verkabelung in Serie
Cableado en serie



CCT/CRI/Flux

	350mA	500mA
2700K	89 lm	128 lm
3000K	93 lm	133 lm
4200K	103 lm	154 lm
6000K	114 lm	165 lm

CRI85

2-Step MacAdam

Photometric diagrams

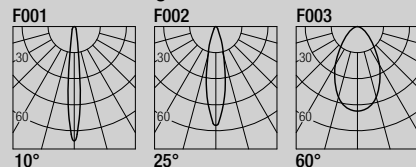

Code Construction

Costruzione del codice - Construction du code produit
Bau der Produkt-Code - Construcción del código de producto

AS X X X X X

Driver	AC	CC					
Alimentatore Driver Alimentation Netzteile Alimentación	Onboard A bordo À bord An Bord	Remoto Remote À distance Fern Remota					
Color Temperature	0	1	2	3	6	7	8
Temperatura colore Température couleur Temperaturabhängige Farbe Temperatura de color	2700K	3000K	4200K	6000K	Blue Blu Bleu Blau Azul	Green Verde Vert Grün	Red Rosso Rouge Rot Rojo
Beam angle	0	1	2				
Apertura di fascio Angle de faisceau Strahlwinkel Ángulo del haz	10°	25°	60°				
Finishing	1	2	5				
Finitura Finitions Oberflächenfinish Acabados	White Bianco Blanc Weiß Blanco	Grey Grigio Gris Grau	Black Nero Noir Schwarz Negro				
Power	1	2					
Potenza Puissance Bestuekung Potencia	1W	2W					

Drivers (CC version only)

Alimentatori - Alimentateurs
Netzteile - Alimentadores

350 mA	500 mA
on/off	on/off
AL1034 (1..11) 30mm IP20	AL4000 (1..12) 72mm IP20 PUSH 0/1..10V
AL1035 (1..11) 40mm IP20	AL4051 (2..14) 72mm IP20 DALI 2
AL1037 (1..16) 55mm IP20 S.P.	AL4053 (1..14) 56mm IP20 PUSH IGBT-TRIAC
AL1074 (1..7) 30mm IP20	AL4010 (1..12) 72mm IP20 PUSH 0/1..10V
AL1077 (1..6) 40mm IP20	AL4151 (2..14) 72mm IP20 DALI 2
AL1084 (1..11) 55mm IP20 S.P.	AL4153 (1..14) 56mm IP20 PUSH IGBT-TRIAC



ARIK 6

design: Roberto Mantovani

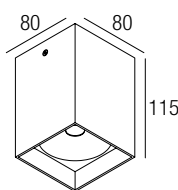

Supply current

Alimentazione
Courant d'alimentation
Stromversorgung
Corriente de alimentación

350-500 mA (V, 8,7V) (CC)
230 VAC (AC)

Power

Potenza
Puissance
Bestuekung
Potencia

3-6 W

Series wiring (CC)

Cablaggio in serie
Câblage en série
Verkabelung in Serie
Cableado en serie



CCT/CRI/Flux

CCT	350mA	500mA
2700K	267 lm	384 lm
3000K	279 lm	400 lm
4200K	309 lm	462 lm
6000K	342 lm	495 lm

CRI85

2-Step MacAdam

Photometric diagrams

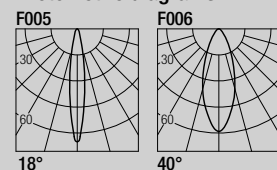

Code Construction

Costruzione del codice - Construction du code produit
Bau der Produkt-Code - Construcción del código de producto

AW X X X X X

Driver

	AC	CC
Alimentatore	Onboard	Remoto
Driver	A bordo	Remote
Alimentation	À bord	À distance
Netzteile	An Bord	Fern
Alimentación		Remota

Color Temperature

	0	1	2	3	6	7	8
Temperatura colore	2700K	3000K	4200K	6000K	Blue	Green	Red
Température couleur					Bleu	Vert	Rouge
Temperaturabhängige Farbe					Blaue	Grün	Rot
Temperatura de color					Azul		Rojo

Beam angle

	1	2
Apertura di fascio	18°	40°
Angle de faisceau		
Strahlwinkel		
Ángulo del haz		

Finishing

	1	2	5
Finitura	White	Grey	Black
Finitions	Bianco	Grigio	Nero
Oberflächenfinish	Blanc	Gris	Noir
Acabados	Weiß	Grau	Schwarz
	Blanco		Negro

Power

	3	6
Potenza	3W	6W
Puissance		
Bestuekung		
Potencia		

Accessories

Accessori - Accessoires
Zubehör - Accesorios

SAW01

Milky screen
Schermo opale
Écran opale
Opal-Bildschirm
Pantalla opal

Note: the screen must be ordered together with the lighting fixture - **Nota:** lo schermo deve essere ordinato congiuntamente all'apparecchio - **Note:** l'écran doit être commandé en même temps que l'appareil
Anmerkung: muss der Bildschirm zusammen mit Leuchtkörper bestellt werden - **Nota:** la pantalla debe pedirse junta con la luminaria

Drivers (CC version only)

Alimentatori - Alimentateurs
Netzteile - Alimentadores

Current	on/off	dimmable	
350 mA	AL1034 (1.3) 30mm IP20	AL4000 (1.4) 72mm IP20 PUSH 0/1..10V	
	AL1035 (1.3) 40mm IP20	AL4051 (1.4) 72mm IP20 DALI 2	
	AL1037 (1.5) 55mm IP20 S.P.	AL4053 (1.4) 56mm IP20 PUSH IGBT-TRIAC	
	500 mA	AL1074 (1.2) 30mm IP20	AL4010 (1.4) 72mm IP20 PUSH 0/1..10V
		AL1077 (1.2) 40mm IP20	AL4151 (1.4) 72mm IP20 DALI 2
		AL1084 (1.3) 55mm IP20 S.P.	AL4153 (1.4) 56mm IP20 PUSH IGBT-TRIAC



ARIK 10

design: Roberto Mantovani

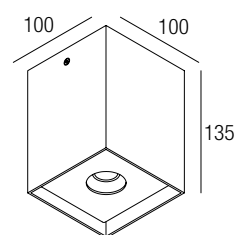

Supply current

Alimentazione
Courant d'alimentation
Stromversorgung
Corriente de alimentación
250 mA (V, 36V) (CC)
230 VAC (AC)

Power

Potenza
Puissance
Bestuekung
Potencia
10 W



CCT/CRI/Flux

2700K — 840 lm
3000K — 930 lm
4000K — 960 lm

Photometric diagrams

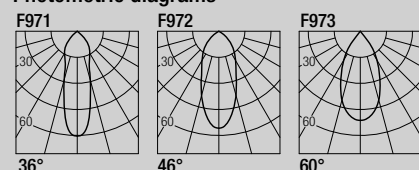

CRI93

2-Step MacAdam



Code Construction

Costruzione del codice - Construction du code produit
Bau der Produkt-Code - Construcción del código de producto

AH X.X.X.X

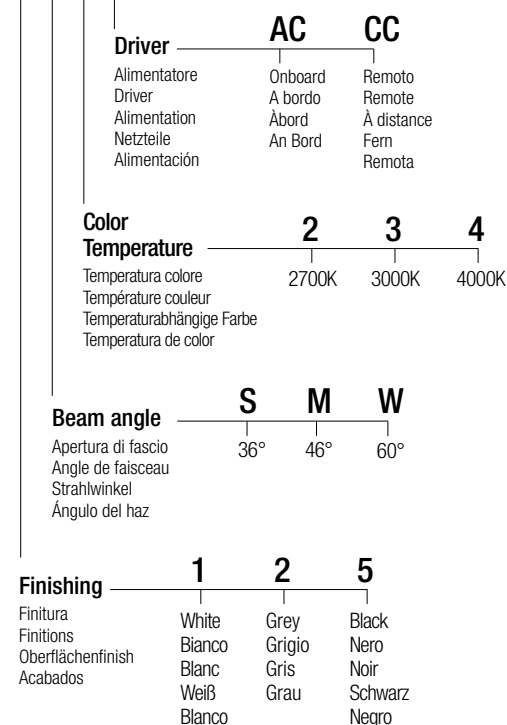

Accessories

Accessori - Accessoires
Zubehör - Accesorios

SAH01

Milky screen
Schermo opale
Écran opale
Opal-Bildschirm
Pantalla opal

Note: the screen must be ordered together with the lighting fixture - **Nota:** lo schermo deve essere ordinato congiuntamente all'apparecchio - **Note:** l'écran doit être commandé en même temps que l'appareil
Anmerkung: muss der Bildschirm zusammen mit Leuchtkörper bestellt werden - **Nota:** la pantalla debe pedirse junta con la luminaria

Drivers (CC version only)

Alimentatori - Alimentateurs
Netzteile - Alimentadores

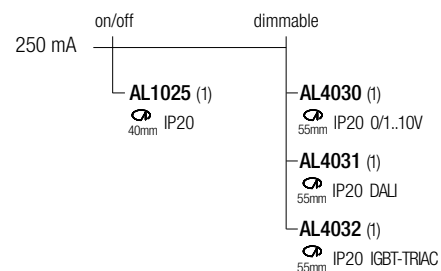

TUBE 6

design: Lapo Grassellini

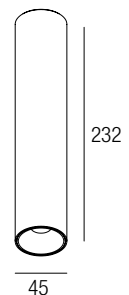

Supply current

Alimentazione
Courant d'alimentation
Stromversorgung
Corriente de alimentación

500 mA (V, 9V) (CC)
230 VAC (AC)

Power

Potenza
Puissance
Bestuekung
Potencia

6 W

Series wiring (CC)

Cablaggio in serie
Câblage en série
Verkabelung in Serie
Cableado en serie



CCT/CRI/Flux

2700K — **540 lm**
3000K — **600 lm**
4000K — **620 lm**

CRI98

2-Step MacAdam

Photometric diagrams

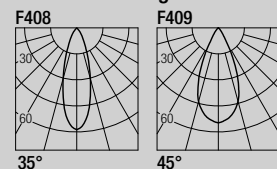

Code Construction

Costruzione del codice - Construction du code produit
Bau der Produkt-Code - Construcción del código de producto

TB6 X X X X

Driver

	AC	CC
Alimentatore	Onboard	Remoto
Driver	A bordo	Remote
Alimentation	À bord	À distance
Netzteile	An Bord	Fern
Alimentación	An Bord	Remota

Color Temperature

	2	3	4
Temperatura colore	2700K	3000K	4000K
Température couleur			
Temperaturabhängige Farbe			
Temperatura de color			

Beam angle

	1	2
Apertura di fascio	35°	45°
Angle de faisceau		
Strahlwinkel		
Ángulo del haz		

Finishing

	1	5
Finitura	White	Black
Finitions	Bianco	Nero
Oberflächenfinish	Blanc	Noir
Acabados	Weiß	Schwarz
	Blanco	Negro

Accessories

Accessori - Accessoires
Zubehör - Accesorios

LTB601

Low luminance louver
Filtro antiabbagliamento
Filtre basse luminance
Geringe Leuchtdichte-Filter
Filtro de baja luminancia

Note: the filter must be ordered together with the lighting fixture - **Nota:** il filtro deve essere ordinato congiuntamente all'apparecchio - **Note:** le filtre doit être commandé en même temps que l'appareil - **Anmerkung:** muss der Filter zusammen mit Leuchtkörper bestellt werden
Nota: el filtro debe pedirse junto con la luminaria

Drivers (CC version only)

Alimentatori - Alimentateurs
Netzteile - Alimentadores

500 mA	on/off	dimnable
AL1074 (1..2)	30mm IP20	AL4010 (1..4) 72mm IP20 PUSH 0/1..10V
AL1077 (1..2)	40mm IP20	AL4151 (1..4) 72mm IP20 DALI2
AL1084 (1..3)	55mm IP20 S.P.	AL4153 (1..4) 56mm IP20 PUSH IGBT-TRIAC



KOINE 2

design: Roberto Mantovani

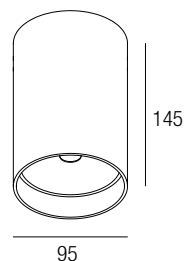

Supply current

Alimentazione
Courant d'alimentation
Stromversorgung
Corriente de alimentación
350-500 mA (V_f 2,9V) (CC)
230 VAC (AC)

Power

Potenza
Puissance
Bestuekung
Potencia
1-2 W

Series wiring (CC)

Cablaggio in serie
Câblage en série
Verkabelung in Serie
Cableado en serie



CCT/CRI/Flux

	350mA	500mA
2700K	89 lm	128 lm
3000K	93 lm	133 lm
4200K	103 lm	154 lm
6000K	114 lm	165 lm

CRI85

2-Step MacAdam

Photometric diagrams

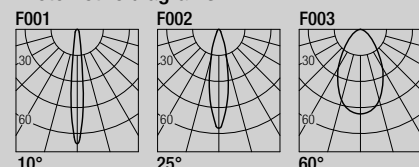

KOINE 6

design: Roberto Mantovani

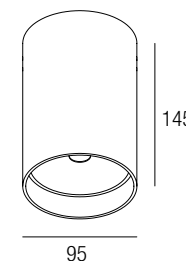

Supply current

Alimentazione
Courant d'alimentation
Stromversorgung
Corriente de alimentación
350-500 mA (V_f 8,7V) (CC)
230 VAC (AC)

Power

Potenza
Puissance
Bestuekung
Potencia
3-6 W

Series wiring (CC)

Cablaggio in serie
Câblage en série
Verkabelung in Serie
Cableado en serie



CCT/CRI/Flux

	350mA	500mA
2700K	267 lm	384 lm
3000K	279 lm	400 lm
4200K	309 lm	462 lm
6000K	342 lm	495 lm

CRI85

2-Step MacAdam

Photometric diagrams

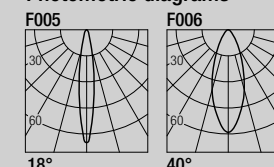

Code Construction

Costruzione del codice - Construction du code produit
Bau der Produkt-Code - Construcción del código de producto

KS X X X X X

Driver	AC	CC
Alimentatore Driver Alimentation Netzteile Alimentación	Onboard A bordo À bord An Bord	Remoto Remote À distance Fern Remota
Color Temperature	0	1 2 3 6 7 8
Temperatura colore Température couleur Temperaturabhängige Farbe Temperatura de color	2700K	3000K 4200K 6000K Blue Blu Bleu Blau Azul Green Verde Vert Grün Red Rosso Rouge Rot Rojo
Beam angle	0	1 2
Apertura di fascio Angle de faisceau Strahlwinkel Ángulo del haz	10°	25° 60°
Finishing	1	2 5
Finitura Finitions Oberflächenfinish Acabados	White Bianco Blanc Weiß Blanco	Grey Grigio Gris Grau Black Nero Noir Schwarz Negro
Power	1	2
Potenza Puissance Bestuekung Potencia	1W	2W

Drivers (CC version only)

Alimentatori - Alimentateurs
Netzteile - Alimentadores

350 mA	on/off	dimmable	
AL1034 (1.11)	30mm IP20	AL4000 (1.12)	72mm IP20 PUSH 0/1..10V
AL1035 (1.11)	40mm IP20	AL4051 (2.14)	72mm IP20 DALI 2
AL1037 (1.16)	55mm IP20 S.P.	AL4053 (1.14)	56mm IP20 PUSH IGBT-TRIAC
500 mA	on/off	dimmable	
AL1074 (1.7)	30mm IP20	AL4010 (1.12)	72mm IP20 PUSH 0/1..10V
AL1077 (1.6)	40mm IP20	AL4151 (2.14)	72mm IP20 DALI 2
AL1084 (1.11)	55mm IP20 S.P.	AL4153 (1.14)	56mm IP20 PUSH IGBT-TRIAC

Code Construction

Costruzione del codice - Construction du code produit
Bau der Produkt-Code - Construcción del código de producto

KW X X X X X

Driver	AC	CC
Alimentatore Driver Alimentation Netzteile Alimentación	Onboard A bordo À bord An Bord	Remoto Remote À distance Fern Remota
Color Temperature	0	1 2 3 6 7 8
Temperatura colore Température couleur Temperaturabhängige Farbe Temperatura de color	2700K	3000K 4200K 6000K Blue Blu Bleu Blau Azul Green Verde Vert Grün Red Rosso Rouge Rot Rojo
Beam angle	1	2
Apertura di fascio Angle de faisceau Strahlwinkel Ángulo del haz	18°	40°
Finishing	1	2 5
Finitura Finitions Oberflächenfinish Acabados	White Bianco Blanc Weiß Blanco	Grey Grigio Gris Grau Black Nero Noir Schwarz Negro
Power	3	6
Potenza Puissance Bestuekung Potencia	3W	6W

Accessories

Accessori - Accessoires
Zubehör - Accesorios

SKW01

Milky screen
Schermo opale
Écran opale
Opal-Bildschirm
Pantalla opal

Note: the screen must be ordered together with the lighting fixture - **Nota:** lo schermo deve essere ordinato congiuntamente all'apparecchio - **Note:** l'écran doit être commandé en même temps que l'appareil
Anmerkung: muss der Bildschirm zusammen mit Leuchtörper bestellt werden - **Nota:** la pantalla debe pedirse junta con la luminaria

Drivers (CC version only)

Alimentatori - Alimentateurs
Netzteile - Alimentadores

350 mA	on/off	dimmable	
AL1034 (1.3)	30mm IP20	AL4000 (1.4)	72mm IP20 PUSH 0/1..10V
AL1035 (1.3)	40mm IP20	AL4051 (1.4)	72mm IP20 DALI 2
AL1037 (1.5)	55mm IP20 S.P.	AL4053 (1.4)	56mm IP20 PUSH IGBT-TRIAC
500 mA	on/off	dimmable	
AL1074 (1.2)	30mm IP20	AL4010 (1.4)	72mm IP20 PUSH 0/1..10V
AL1077 (1.2)	40mm IP20	AL4151 (1.4)	72mm IP20 DALI 2
AL1084 (1.3)	55mm IP20 S.P.	AL4153 (1.4)	56mm IP20 PUSH IGBT-TRIAC

KOINE 10

design: Roberto Mantovani

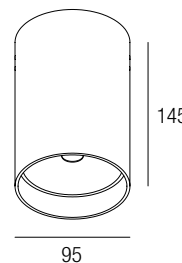

Supply current
 Alimentazione
 Courant d'alimentation
 Stromversorgung
 Corriente de alimentación
250 mA (V, 36V) (CC)
230 VAC (AC)

Power
 Potenza
 Pouissance
 Bestuekung
 Potencia
10 W



CCT/CRI/Flux

2700K — 840 lm
 3000K — 930 lm
 4000K — 960 lm

Photometric diagrams

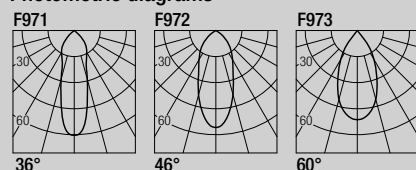

CRI93
2-Step MacAdam



Code Construction

Costruzione del codice - Construction du code produit
 Bau der Produkt-Code - Construcción del código de producto

KH X.X.X.X

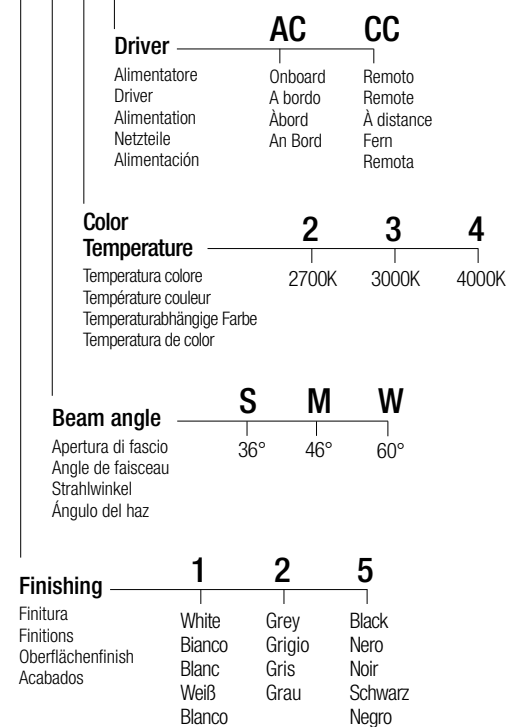

Accessories

Accessori - Accessoires
 Zubehör - Accesorios

SKH01

Milky screen
 Schermo opale
 Écran opale
 Opal-Bildschirm
 Pantalla opal

Note: the screen must be ordered together with the lighting fixture - **Nota:** lo schermo deve essere ordinato congiuntamente all'apparecchio - **Note:** l'écran doit être commandé en même temps que l'appareil
Anmerkung: muss der Bildschirm zusammen mit Leuchtkörper bestellt werden - **Nota:** la pantalla debe pedirse junta con la luminaria

Drivers (CC version only)

Alimentatori - Alimentateurs
 Netzteile - Alimentadores

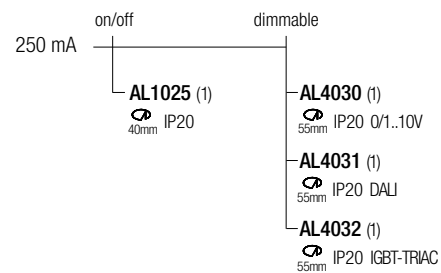

ELF 2

design: Roberto Mantovani

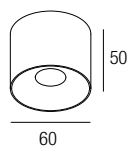

Supply current

Alimentazione
Courant d'alimentation
Stromversorgung
Corriente de alimentación
350-500 mA (V, 2, 9V)

Power

Potenza
Puissance
Bestuekung
Potencia
1-2 W

Series wiring

Cablaggio in serie
Câblage en série
Verkabelung in Serie
Cableado en serie



Photometric diagrams

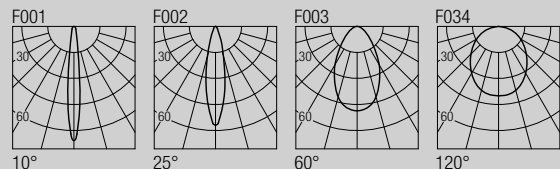

CCT/CRI/Flux	350mA	500mA
2700K	89lm	128lm
3000K	93lm	133lm
4200K	103lm	154lm
6000K	114lm	165lm
CRI85		
2-Step MacAdam		



Code Construction

Costruzione del codice - Construction du code produit
Bau der Produkt-Code - Construcción del código de producto

EF2 X, X, X

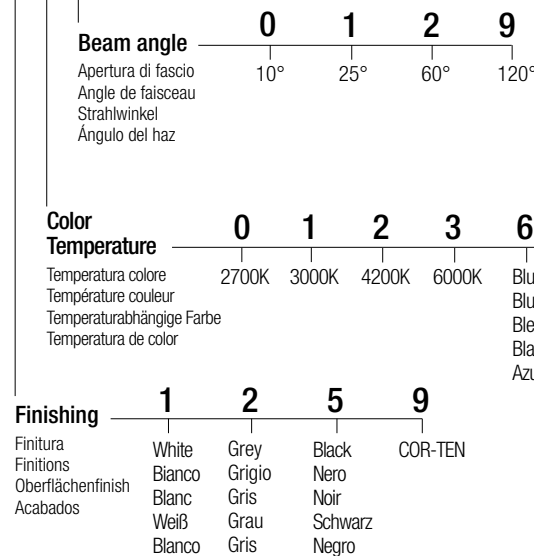

Drivers

Alimentatori - Alimentateurs
Netzteile - Alimentadores

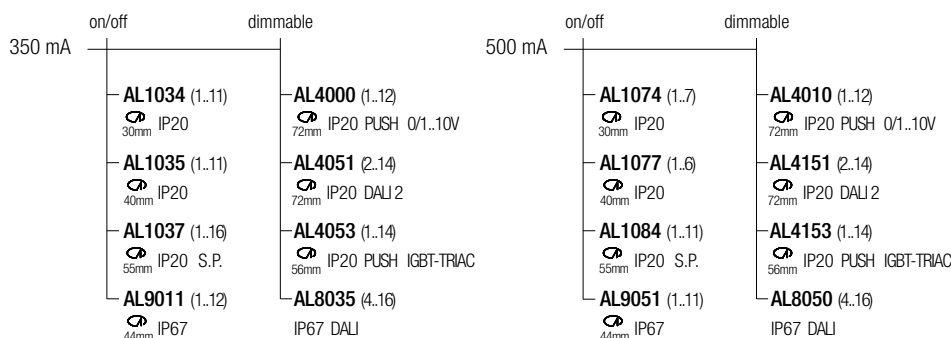

ELF 6

design: Roberto Mantovani

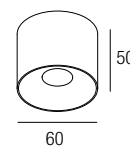

Supply current

Alimentazione
Courant d'alimentation
Stromversorgung
Corriente de alimentación
350-500 mA (V, 8, 7V)

Power

Potenza
Puissance
Bestuekung
Potencia
3-6 W

Series wiring

Cablaggio in serie
Câblage en série
Verkabelung in Serie
Cableado en serie



Photometric diagrams

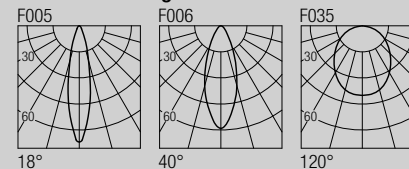

CCT/CRI/Flux	350mA	500mA
2700K	267lm	384lm
3000K	279lm	400lm
4200K	309lm	462lm
6000K	342lm	495lm
CRI98		
2-Step MacAdam		



Code Construction

Costruzione del codice - Construction du code produit
Bau der Produkt-Code - Construcción del código de producto

EF6 X, X, X

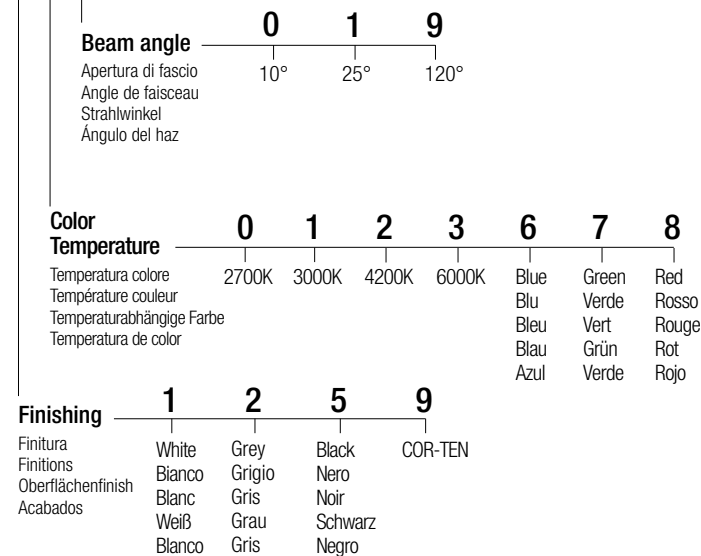

Drivers

Alimentatori - Alimentateurs
Netzteile - Alimentadores

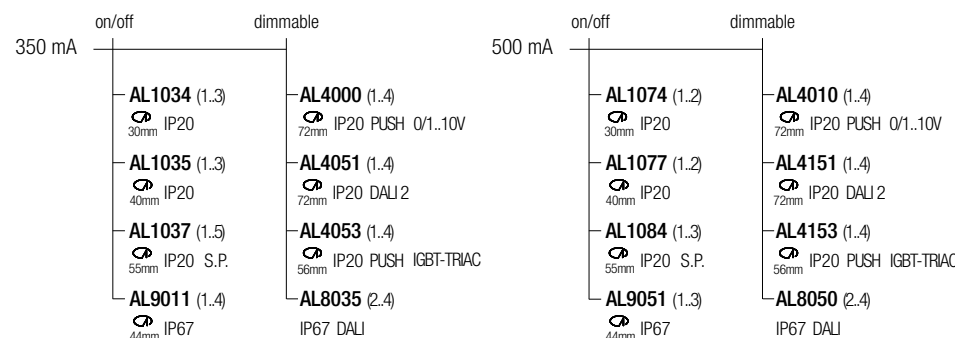

Accessories

Accessori - Accessoires
Zubehör - Accesorios

LEF601

Low luminance louver
Filtro antiabbagliamento
Filtre basse luminance
Geringe Leuchtdichte-Filter
Filtro de baja luminancia



Note: the filter and the screen must be ordered together with the lighting fixture - **Nota:** il filtro e lo schermo devono essere ordinati congiuntamente all'apparecchio - **Note:** le filtre et l'écran doivent être commandées en même temps que l'appareil
Anmerkung: müssen der Filter und der Bildschirm zusammen mit Leuchtkörper bestellt werden
Nota: el filtro y la pantalla deben pedirse juntos con la luminaria

Note: cable cut to measure on request
Nota: cavo a misura disponibile su richiesta
Note: câble sur mesure disponible sur demande
Anmerkung: kundenspezifisches Kabel auf Anfrage erhältlich
Nota: cable a medida disponible a petición

ELF 10

design: Roberto Mantovani

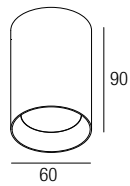

Supply current

Alimentazione
Courant d'alimentation
Stromversorgung
Corriente de alimentación

500 mA (V_r, 18V)

Power

Potenza
Puissance
Bestuekung
Potencia

10 W

Series wiring

Cablaggio in serie
Câblage en série
Verkabelung in Serie
Cableado en serie



Photometric diagrams

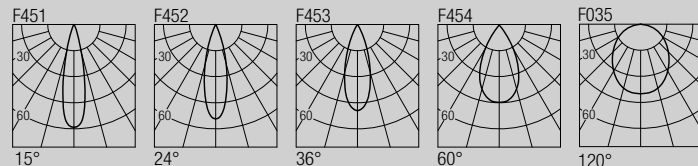

CCT/CRI/Flux

	CRI85	CRI93
2700K	890lm	840lm
3000K	1000lm	930lm
4000K	1040lm	960lm

CRI85-93

2-Step MacAdam



Code Construction

Costruzione del codice - Construction du code produit
Bau der Produkt-Code - Construcción del código de producto

EF1 X X X X

Beam angle

	N	S	M	W	X
Apertura di fascio Angle de faisceau Strahlwinkel Ángulo del haz	15°	24°	36°	60°	120°

CRI

8	9
85	93

Color Temperature

2	3	4
2700K	3000K	4000K
Temperatura colore Température couleur Temperaturabhängige Farbe Temperatura de color		

Finishing

1	2	5	9
White Bianco Blanc Weiß Blanco	Grey Grigio Gris	Black Nero Noir Schwarz Negro	COR-TEN
Finitura Finitions Oberflächenfinish Acabados			

Note: cable cut to measure on request

Nota: cavo a misura disponibile su richiesta

Note: câble sur mesure disponible sur demande

Anmerkung: kundenspezifisches Kabel auf Anfrage erhältlich

Nota: cable a medida disponible a petición

Accessories

Accessori - Accessoires
Zubehör - Accesorios

LEF101

Low luminance louver
Filtro antiabbagliamento
Filtre basse luminance
Geringe Leuchtdichte-Filter
Filtro de baja luminancia

Note: the filter and the screen must be ordered together with the lighting fixture - Nota: il filtro e lo schermo devono essere ordinati congiuntamente all'apparecchio - Note: le filtre et l'écran doivent être commandées en même temps que l'appareil
Anmerkung: müssen der Filter und der Bildschirm zusammen mit Leuchtkörper bestellt werden
Nota: el filtro y la pantalla deben pedirse juntos con la luminaria

Drivers

Alimentatori - Alimentateurs
Netzteile - Alimentadores

on/off	dimmable
500 mA	
AL1074 (1) 30mm IP20	AL4010 (1.2) 72mm IP20 PUSH 0/1..10V
AL1077 (1) 40mm IP20	AL4151 (1.2) 72mm IP20 DALI 2
AL1084 (1.2) 55mm IP20 S.P.	AL4153 (1.2) 56mm IP20 PUSH IGBT-TRIAC
AL9051 (1.2) 44mm IP67	AL8050 (1.2) IP67 DALI

ELF 724

design: Roberto Mantovani

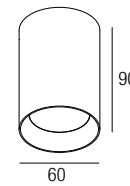

Supply current

Alimentazione
Courant d'alimentation
Stromversorgung
Corriente de alimentación

500 mA (V_r, 18V)

Power

Potenza
Puissance
Bestuekung
Potencia

7 W

Series wiring

Cablaggio in serie
Câblage en série
Verkabelung in Serie
Cableado en serie



Photometric diagrams

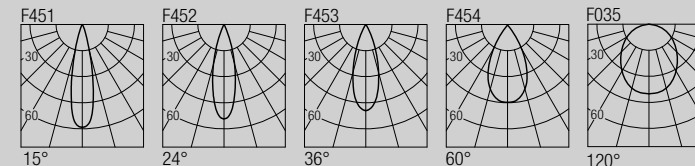

CCT/CRI/Flux

	CRI85	CRI93
2700K	630lm	590lm
3000K	700lm	650lm
4000K	730lm	670lm

CRI85-93

2-Step MacAdam



Code Construction

Costruzione del codice - Construction du code produit
Bau der Produkt-Code - Construcción del código de producto

EF24 X X X X

Beam angle

	N	S	M	W	X
Apertura di fascio Angle de faisceau Strahlwinkel Ángulo del haz	15°	24°	36°	60°	120°

CRI

8	9
85	93

Color Temperature

2	3	4
2700K	3000K	4000K
Temperatura colore Température couleur Temperaturabhängige Farbe Temperatura de color		

Finishing

1	2	5	9
White Bianco Blanc Weiß Blanco	Grey Grigio Gris	Black Nero Noir Schwarz Negro	COR-TEN
Finitura Finitions Oberflächenfinish Acabados			

Note: cable cut to measure on request

Nota: cavo a misura disponibile su richiesta

Note: câble sur mesure disponible sur demande

Anmerkung: kundenspezifisches Kabel auf Anfrage erhältlich

Nota: cable a medida disponible a petición

Accessories

Accessori - Accessoires
Zubehör - Accesorios

LEF2401

Low luminance louver
Filtro antiabbagliamento
Filtre basse luminance
Geringe Leuchtdichte-Filter
Filtro de baja luminancia

Note: the filter and the screen must be ordered together with the lighting fixture - Nota: il filtro e lo schermo devono essere ordinati congiuntamente all'apparecchio - Note: le filtre et l'écran doivent être commandées en même temps que l'appareil
Anmerkung: müssen der Filter und der Bildschirm zusammen mit Leuchtkörper bestellt werden
Nota: el filtro y la pantalla deben pedirse juntos con la luminaria

Drivers

Alimentatori - Alimentateurs
Netzteile - Alimentadores

on/off	dimming module	dimmable
24 VDC		
AL2012 (1..3) 60mm IP20	AL7035 IP20 PUSH DALI 0/1..10V	AL5012 (1..3) 45mm IP20 PUSH DALI 0/1..10V
AL2031 (1..10) 70mm IP20		AL8012 (1..3) IP67 DALI
AL2040 (1..21) 80mm IP20		
AL9212 (1..2) 110mm IP67		
AL9231 (1..10) 85mm IP67		
AL9240 (1..21) 85mm IP67		

Note: dimming module AL7035 to be used in combination with an on/off 24VDC power supply Nota: modulo di dimmerazione AL7035 da utilizzare in combinazione con un alimentatore on/off 24VDC Note: module de variation AL7035 d'intensité à utiliser en combinaison avec une alimentation on/off 24VDC Anmerkung: Dimmmodul AL7035 zur Verwendung in Kombination mit einem on/off 24VDC-Netzteil Nota: módulo de regulación AL7035 se utiliza en combinación con una fuente de alimentación on/off 24VDC

CUBE 2030

design: Roberto Mantovani

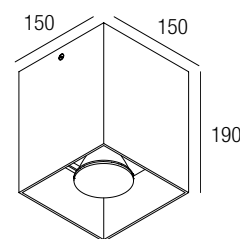

Supply current

Alimentazione
Courant d'alimentation
Stromversorgung
Corriente de alimentación

230 VAC

Power

Potenza
Puissance
Bestuekung
Potencia

20W - 30W



Photometric diagrams

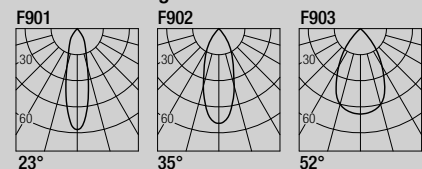

CCT/CRI/Flux

	CRI85	CRI93	
2700K	1830 lm	1700 lm	20W
3000K	2560 lm	2380 lm	30W
4000K	2000 lm	1830 lm	20W
	2800 lm	2560 lm	30W
	2100 lm	1950 lm	20W
	2940 lm	2730 lm	30W

CRI85 - CRI93
2-Step MacAdam



Code Construction

Costruzione del codice - Construction du code produit
Bau der Produkt-Code - Construcción del código de producto

CU X X X X X

Beam angle — S — M — W
Apertura di fascio 23° 35° 52°
Angle de faisceau
Strahlwinkel
Ángulo del haz

CRI — 8 — 9
85 93

Color Temperature — 2 — 3 — 4
Temperatura colore 2700K 3000K 4000K
Température couleur
Temperaturabhängige Farbe
Temperatura de color

Finishing — 1 — 2 — 5
Finitura White Grey Black
Finitions Bianco Grigio Nero
Oberflächenfinish Blanc Gris Noir
Acabados Weiß Grau Schwarz
Blanco Blanco Negro

Power — 2 — 3
Potenza 20W 30W
Puissance
Bestuekung
Potencia

Note: dimmable version available on request

Nota: versioni dimmerabili disponibili su richiesta

Note: version dimmable disponible sur demande

Anmerkung: dimmbare Version auf Anfrage

Nota: versiones regulables disponibles bajo petición



ART

design: Roberto Mantovani

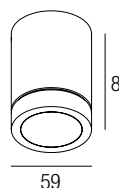

Supply current

Alimentazione
Courant d'alimentation
Stromversorgung
Corriente de alimentación

24 VDC

Power

Potenza
Puissance
Bestuekung
Potencia

7 W

Parallel wiring

Cablaggio in parallelo
Câblage en parallèle
Verkabelung
Cableado en paralelo



Photometric diagrams

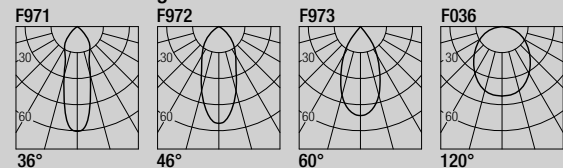

CCT/CRI/Flux

	CRI85	CRI93
2700K	630 lm	590 lm
3000K	700 lm	650 lm
4000K	730 lm	670 lm

CRI85 - CRI93

2-Step MacAdam



Code Construction

Costruzione del codice - Construction du code produit
Bau der Produkt-Code - Construcción del código de producto

AT1 X X X X

Beam angle

	S	M	W	X
Apertura di fascio	36°	46°	60°	120°
Angle de faisceau				
Strahlwinkel				
Ángulo del haz				

CRI

	8	9
	85	93

Color Temperature

	2	3	4
Temperatura colore	2700K	3000K	4000K
Température couleur			
Temperaturabhängige Farbe			
Temperatura de color			

Finishing

	2	5	6
Finitura	Aluminium	Black	Bronze
Finitions	Alluminio	Nero	Bronzo
Oberflächenfinish	Aluminium	Noir	Bronce
Acabados	Aluminio	Schwarz	Negro

Accessories

Accessori - Accessoires
Zubehör - Accesorios

LAT101

Low luminance louver
Filtro antiabbagliamento
Filtre basse luminance
Geringe Leuchtdichte-Filter
Filtro de baja luminancia

Note: the filter must be ordered together with the lighting fixture - **Nota:** il filtro deve essere ordinato congiuntamente all'apparecchio - **Note:** le filtre doit être commandé en même temps que l'appareil - **Anmerkung:** muss der Filter zusammen mit Leuchtkörper bestellt werden
Nota: el filtro debe pedirse junto con la luminaria

Note: cable cut to measure on request
Nota: cavo a misura disponibile su richiesta
Note: câble sur mesure disponible sur demande
Anmerkung: kundenspezifisches Kabel auf Anfrage erhältlich
Nota: cable a medida disponible a petición

Drivers

Alimentatori - Alimentateurs
Netzteile - Alimentadores

24 VDC	on/off	dimming module	dimmable
AL2012 (1..3)	AL7035	AL5012 (1..3)	
60mm IP20	IP20 PUSH DALI 0/1..10V	45mm IP20 PUSH DALI 0/1..10V	
AL2031 (1..10)		AL8012 (1..3)	
70mm IP20		IP67 DALI	
AL2040 (1..21)	Note: dimming module AL7035 to be used in combination with an on/off 24VDC power supply Nota: modulo di dimmerazione AL7035 da utilizzare in combinazione con un alimentatore on/off 24VDC Note: module de variation AL7035 d'intensité à utiliser en combinaison avec une alimentation on/off 24VDC Anmerkung: Dimmmodul AL7035 zur Verwendung in Kombination mit einem on/off 24VDC-Netzteil Nota: módulo de regulación AL7035 se utiliza en combinación con una fuente de alimentación on/off 24VDC		
80mm IP20			
AL9212 (1..2)			
110mm IP67			
AL9231 (1..10)			
85mm IP67			
AL9240 (1..21)			
85mm IP67			



SASABUNE

design: Lapo Grassellini

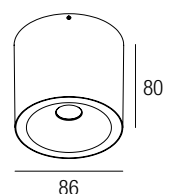

Supply current
 Alimentazione
 Courant d'alimentation
 Stromversorgung
 Corriente de alimentación
230 VAC

Power
 Potenza
 Puissance
 Bestuekung
 Potencia
8 W



CCT/CRI/Flux

	CRI85	CRI93
2700K	730 lm	690 lm
3000K	830 lm	770 lm
4000K	860 lm	790 lm

Photometric diagrams

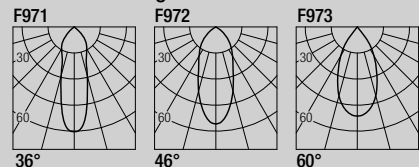

CRI85 - CRI93
2-Step MacAdam

Code Construction

Costruzione del codice - Construction du code produit
 Bau der Produkt-Code - Construcción del código de producto

SB1 X X X X

Beam angle Apertura di fascio Angle de faisceau Strahlwinkel Ángulo del haz	S 36°	M 46°	W 60°
CRI	8 85	9 93	
Color Temperature Temperatura colore Température couleur Temperaturabhängige Farbe Temperatura de color	2 2700K	3 3000K	4 4000K
Finishing Finitura Finitions Oberflächenfinish Acabados	1 White Bianco Blanc Weiß Blanco	2 Grey Grigio Gris Grau	5 Black Nero Noir Schwarz Negro



LEV S7

design: Roberto Mantovani

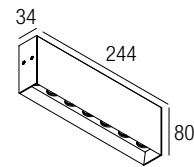

Supply current

Alimentazione
Courant d'alimentation
Stromversorgung
Corriente de alimentación

24 VDC

Power

Potenza
Puissance
Bestuekung
Potencia

7 W

Parallel wiring

Cablaggio in parallelo
Câblage en parallèle
Verkabelung in parallel
Cableado en paralelo



CCT/CRI/Flux

2700K — 623 lm
3000K — 651 lm
4200K — 721 lm

Photometric diagrams

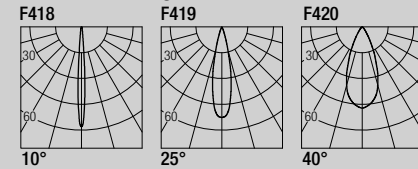

CRI85

2-Step MacAdam

Code Construction

Costruzione del codice - Construction du code produit
Bau der Produkt-Code - Construcción del código de producto

LVS1 X X X

Beam angle

Apertura di fascio
Angle de faisceau
Strahlwinkel
Ángulo del haz

S	M	W
10°	25°	40°

Color Temperature

Temperatura colore
Température couleur
Temperaturabhängige Farbe
Temperatura de color

2	3	4
2700K	3000K	4200K

Finishing

1	5
White	Black
Bianco	Nero
Blanc	Noir
Weiß	Schwarz
Blanco	Negro

Drivers

Alimentatori - Alimentateurs
Netzteile - Alimentadores

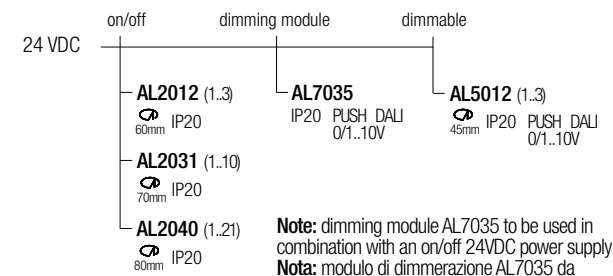

Note: dimming module AL7035 to be used in combination with an on/off 24VDC power supply
Nota: modulo di dimmerazione AL7035 da utilizzare in combinazione con un alimentatore on/off 24VDC
Note: module de variation AL7035 d'intensité à utiliser en combinaison avec une alimentation on/off 24VDC
Anmerkung: Dimmmodul AL7035 zur Verwendung in Kombination mit einem on/off 24VDC-Netzteil
Nota: módulo de regulación AL7035 se utiliza en combinación con una fuente de alimentación on/off 24VDC

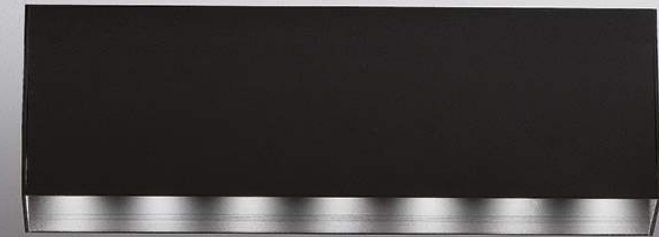

LEV S14

design: Roberto Mantovani

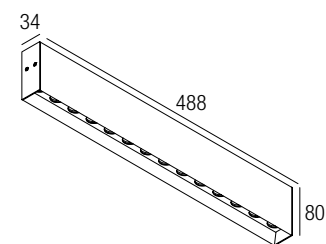

Supply current

Alimentazione
Courant d'alimentation
Stromversorgung
Corriente de alimentación
24 VDC

Power

Potenza
Puissance
Bestuekung
Potencia
14 W

Parallel wiring

Cablaggio in parallelo
Câblage en parallèle
Verkabelung in parallel
Cableado en paralelo



CCT/CRI/Flux

2700K — 1246 lm
3000K — 1302 lm
4200K — 1442 lm

Photometric diagrams

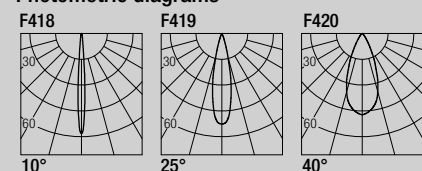

CRI85

2-Step MacAdam

Code Construction

Costruzione del codice - Construction du code produit
Bau der Produkt-Code - Construcción del código de producto

LVS2 X X X

Beam angle Apertura di fascio Angle de faisceau Strahlwinkel Angulo del haz	S 10°	M 25°	W 40°
Color Temperature Temperatura colore Température couleur Temperaturabhängige Farbe Temperatura de color	2 2700K	3 3000K	4 4200K
Finishing Finitura Finitions Oberflächenfinish Acabados	1 White Bianco Blanc Weiß Blanco	5 Black Nero Noir Schwarz Negro	

Drivers

Alimentatori - Alimentateurs
Netzteile - Alimentadores

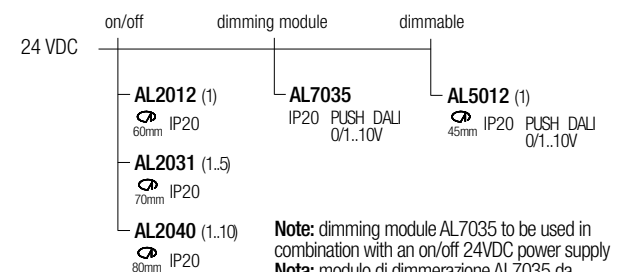

Note: dimming module AL7035 to be used in combination with an on/off 24VDC power supply
Nota: modulo di dimmerazione AL7035 da utilizzare in combinazione con un alimentatore on/off 24VDC
Note: module de variation AL7035 d'intensité à utiliser en combinaison avec une alimentation on/off 24VDC
Anmerkung: Dimmmodul AL7035 zur Verwendung in Kombination mit einem on/off 24VDC-Netzteil
Nota: módulo de regulación AL7035 se utiliza en combinación con una fuente de alimentación on/off 24VDC



KELLER S

design: Roberto Mantovani

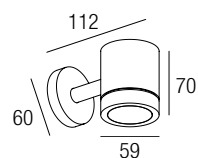

Supply current

Alimentazione
Courant d'alimentation
Stromversorgung
Corriente de alimentación
24 VDC

Power

Potenza
Puissance
Bestuekung
Potencia
7 W

Parallel wiring

Cablaggio in parallelo
Câblage en parallèle
Verkabelung in parallel
Cableado en paralelo



Photometric diagrams

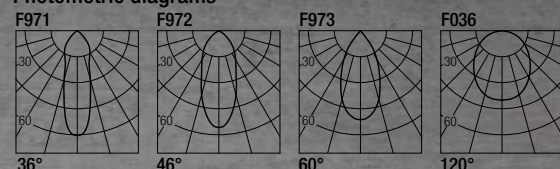

CCT/CRI/Flux

	CRI85	CRI93
2700K	630 lm	590 lm
3000K	700 lm	650 lm
4000K	730 lm	670 lm

CRI85 - CRI93

2-Step MacAdam

Code Construction

Costruzione del codice - Construction du code produit
Bau der Produkt-Code - Construcción del código de producto

KE1 X X X X

Beam angle — S M W X
Apertura di fascio — 36° 46° 60° 120°
Angle de faisceau
Strahlwinkel
Ángulo del haz

CRI — 8 9
85 93

Color Temperature — 2 3 4
Temperatura colore — 2700K 3000K 4000K
Température couleur
Temperaturabhängige Farbe
Temperatura de color

Finishing — 2 5 6
Finitura — Aluminium Black Bronze
Finitions — Aluminium Noir Bronze
Oberflächenfinish — Aluminium Schwarz Bronze
Acabados — Aluminio Negro

Accessories

Accessori - Accessoires
Zubehör - Accesorios

LKE101

Low luminance louver
Filtro antiabbagliamento
Filtre basse luminance
Geringe Leuchtdichte-Filter
Filtro de baja luminancia

Note: the filter must be ordered together with the lighting fixture - **Nota:** il filtro deve essere ordinato congiuntamente all'apparecchio - **Note:** le filtre doit être commandé en même temps que l'appareil - **Anmerkung:** muss der Filter zusammen mit Leuchtkörper bestellt werden
Nota: el filtro debe pedirse junto con la luminaria

Note: cable cut to measure on request
Nota: cavo a misura disponibile su richiesta
Note: câble sur mesure disponible sur demande
Anmerkung: kundenspezifisches Kabel auf Anfrage erhältlich
Nota: cable a medida disponible a petición

Drivers

Alimentatori - Alimentateurs
Netzteile - Alimentadores

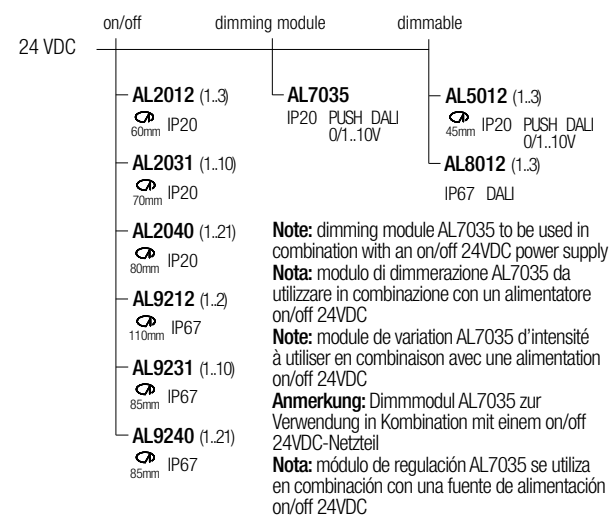

KELLER D

design: Roberto Mantovani

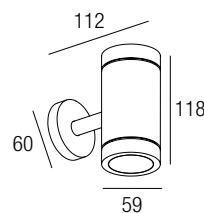

Supply current

Alimentazione
Courant d'alimentation
Stromversorgung
Corriente de alimentación

24 VDC

Power

Potenza
Puissance
Bestuekung
Potencia

2 x 7 W

Parallel wiring

Cablaggio in parallelo
Câblage en parallèle
Verkabelung in parallel
Cableado en paralelo



Photometric diagrams

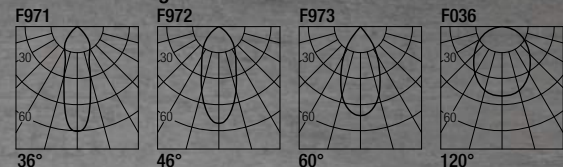

CCT/CRI/Flux

	CRI85	CRI93
2700K	2 x 630 lm	2 x 590 lm
3000K	2 x 700 lm	2 x 650 lm
4000K	2 x 730 lm	2 x 670 lm

CRI85 - CRI93

2-Step MacAdam



Code Construction

Costruzione del codice - Construction du code produit
Bau der Produkt-Code - Construcción del código de producto

KE2 X X X X X

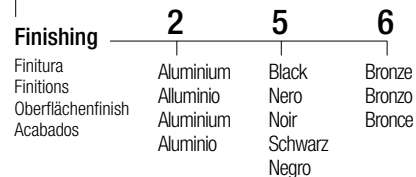
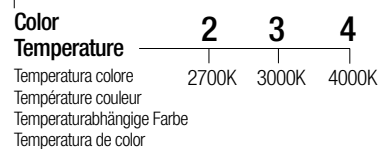
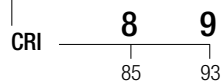
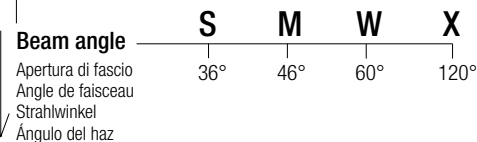
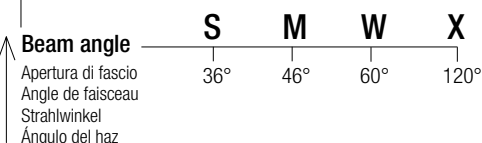

Accessories

Accessori - Accessoires
Zubehör - Accesorios

LKE201

(2 pcs)

Low luminance louver
Filtro antiabbagliamento
Filtre basse luminance
Geringe Leuchtdichte-Filter
Filtro de baja luminancia

Note: the filter must be ordered together with the lighting fixture - **Nota:** il filtro deve essere ordinato congiuntamente all'apparecchio - **Note:** le filtre doit être commandé en même temps que l'appareil - **Anmerkung:** muss der Filter zusammen mit Leuchtkörper bestellt werden
Nota: el filtro debe pedirse junto con la luminaria

Note: cable cut to measure on request
Nota: cavo a misura disponibile su richiesta
Note: câble sur mesure disponible sur demande
Anmerkung: kundenspezifisches Kabel auf Anfrage erhältlich
Nota: cable a medida disponible a petición

Drivers

Alimentatori - Alimentateurs
Netzteile - Alimentadores

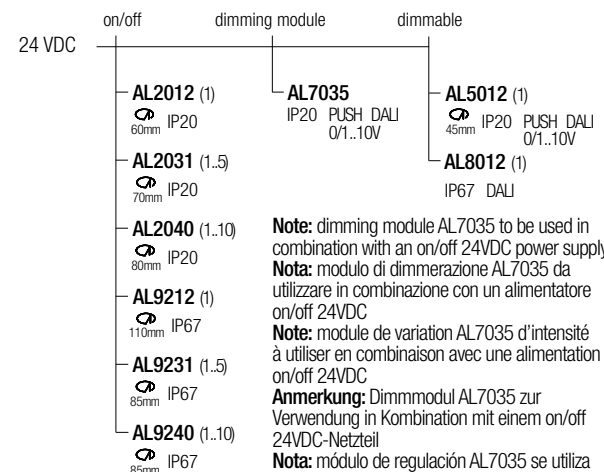

Note: dimming module AL7035 to be used in combination with an on/off 24VDC power supply
Nota: modulo di dimmerazione AL7035 da utilizzare in combinazione con un alimentatore on/off 24VDC
Note: module de variation AL7035 d'intensité à utiliser en combinaison avec une alimentation on/off 24VDC
Anmerkung: Dimmmodul AL7035 zur Verwendung in Kombination mit einem on/off 24VDC-Netzteil
Nota: módulo de regulación AL7035 se utiliza en combinación con una fuente de alimentación on/off 24VDC



MARUPE 12

design: Roberto Mantovani

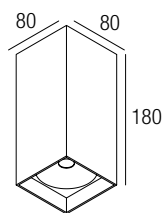

Supply current

Alimentazione
Courant d'alimentation
Stromversorgung
Corriente de alimentación

350-500 mA (V, 8, 7V) (CC)
230 VAC (AC)

Power

Potenza
Puissance
Bestuekung
Potencia

3-6 W (single)
6-12 W (double)

Series wiring (CC)

Cablaggio in serie
Câblage en série
Verkabelung in Serie
Cableado en serie



CCT/CRI/Flux

CCT	350mA	500mA
2700K	267 lm	384 lm
3000K	279 lm	400 lm
4200K	309 lm	462 lm
6000K	342 lm	495 lm

CRI85

2-Step MacAdam

Photometric diagrams

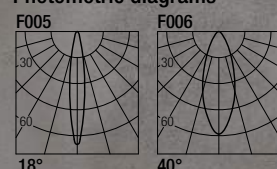

Code Construction

Costruzione del codice - Construction du code produit
Bau der Produkt-Code - Construcción del código de producto

MW X X X X X X X

Driver	AC	CC
Alimentatore Driver Alimentation Netzteile Alimentación	Onboard A bordo Abord An Bord	Remoto Remote À distance Fern Remota
Color Temperature	0	1
Temperatura colore Température couleur Temperaturabhängige Farbe Temperatura de color	2700K	3000K
Beam angle	1	2
Apertura di fascio Angle de faisceau Strahlwinkel Ángulo del haz	18°	40°
Beam angle	1	2
Apertura di fascio Angle de faisceau Strahlwinkel Ángulo del haz	18°	40°
Finishing	1	2
Finitura Finitions Oberflächenfinish Acabados	White Bianco Blanc Weiß Blanco	Grey Grigio Gris Grau Black Nero Noir Schwarz Negro
Supply current	1	2
Alimentazione Courant d'alimentation Stromversorgung Corriente de alimentación	350mA	500mA
Emission	1	2
Emissione Émission	Single Singola Unique Einzel Único	Double Doppia Doppel Doble

Drivers (CC version only)

Alimentatori - Alimentateurs
Netzteile - Alimentadores

350 mA	on/off	dimmable
AL1034 (1.3/1)	IP20	AL4000 (1.4/1.2)
AL1035 (1.3/1)	IP20	AL4051 (1.4/1.2)
AL1037 (1.5/1.2)	IP20 S.P.	AL4053 (1.4/1.2)
500 mA	on/off	dimmable
AL1074 (1.2/1)	IP20	AL4010 (1.4/1.2)
AL1077 (1.2/1)	IP20	AL4151 (1.4/1.2)
AL1084 (1.3/1)	IP20 S.P.	AL4153 (1.4/1.2)



GAGA

design: Lapo Grassellini

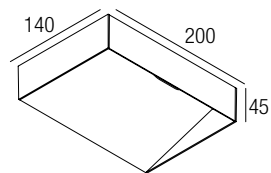

Supply current

Alimentazione
Courant d'alimentation
Stromversorgung
Corriente de alimentación

230 VAC

Power

Potenza
Puissance
Bestuekung
Potencia

2 x 10 W

Dimmable IGBT-TRIAC

Dimmerabile IGBT-TRIAC
Dimmable IGBT-TRIAC
Dimmbar IGBT-TRIAC
Regulable IGBT-TRIAC

IP40

CCT/CRI/Flux

	CRI85	CRI93
2700K	2 x 890 lm	2 x 840 lm
3000K	2 x 1000 lm	2 x 930 lm
4000K	2 x 1040 lm	2 x 960 lm

CRI85 - CRI93

2-Step MacAdam

Code Construction

Costruzione del codice - Construction du code produit
Bau der Produkt-Code - Construcción del código de producto

GG1 X X X

CRI	8	9	
	85	93	
Color Temperature	2	3	4
Temperatura colore	2700K	3000K	4000K
Température couleur			
Temperaturabhängige Farbe			
Temperatura de color			
Finishing	1	2	5
Finitura	White	Grey	Black
Finitions	Bianco	Grigio	Nero
Oberflächenfinish	Blanc	Gris	Noir
Acabados	Weiß	Grau	Schwarz
	Blanco		Negro



HULA

design: Lapo Grassellini

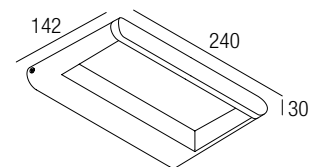

Supply current

Alimentazione
Courant d'alimentation
Stromversorgung
Corriente de alimentación

230 VAC

Power

Potenza
Puissance
Bestuekung
Potencia

6 W

□ **IP65**

CCT/CRI/Flux

2700K — 480 lm
3000K — 510 lm
4000K — 560 lm

CRI85

2-Step MacAdam



Code Construction

Costruzione del codice - Construction du code produit
Bau der Produkt-Code - Construcción del código de producto

HL1 X X

Color Temperature	2	3	4
Temperatura colore	2700K	3000K	4000K
Température couleur			
Temperaturabhängige Farbe			
Temperatura de color			

Finishing	1	2	5
Finitura	White	Grey	Black
Finitions	Bianco	Grigio	Nero
Oberflächenfinish	Blanc	Gris	Noir
Acabados	Weiß Blanco	Grau	Schwarz Negro



CADMO 6

design: Roberto Mantovani

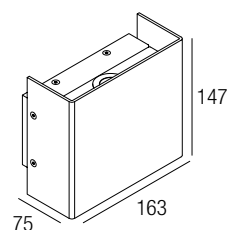

Supply current

Alimentazione
Courant d'alimentation
Stromversorgung
Corriente de alimentación

350-500 mA (V_i 8,7V)

Power

Potenza
Puissance
Bestuekung
Potencia

3-6 W (single)
6-12 W (double)

Series wiring

Cablaggio in serie
Câblage en série
Verkabelung in Serie
Cableado en serie



Photometric diagrams

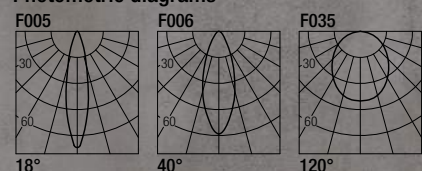

CCT/CRI/Flux

	350mA	500mA
2700K	267 lm	384 lm
3000K	279 lm	400 lm
4200K	309 lm	462 lm
6000K	342 lm	495 lm

CRI85

2-Step MacAdam



Code Construction

Costruzione del codice - Construction du code produit
Bau der Produkt-Code - Construcción del código de producto

PXP X X X X X

Beam angle	S	F	W	D
Apertura di fascio	18°	40°	120°	Blind
Angle de faisceau	18°	40°	120°	Cieco
Strahlwinkel	18°	40°	120°	Borgne
Ángulo del haz	18°	40°	120°	Ciego

Beam angle	S	F	W	D
Apertura di fascio	18°	40°	120°	Blind
Angle de faisceau	18°	40°	120°	Cieco
Strahlwinkel	18°	40°	120°	Borgne
Ángulo del haz	18°	40°	120°	Ciego

Color Temperature	0	1	2	3	6	7	8
Temperatura colore	2700K	3000K	4200K	6000K	Blue	Green	Red
Température couleur	2700K	3000K	4200K	6000K	Blu	Vert	Rosso
Temperaturabhängige Farbe	2700K	3000K	4200K	6000K	Bleu	Vert	Rouge
Temperatura de color	2700K	3000K	4200K	6000K	Blau	Grün	Rot
					Azul		Rojo

Finishing	1	2	5	9
Finitura	White	Grey	Black	COR-TEN
Finitions	Bianco	Grigio	Nero	
Oberflächenfinish	Blanc	Gris	Noir	
Acabados	Weiß	Grau	Schwarz	
	Blanco		Negro	

Emission	1	2
Emissione	Single	Double
Émission	Singola	Doppia
	Unique	Doppel
	Einzel	Doble
	Único	

Drivers (CC version only)

Alimentatori - Alimentateurs
Netzteile - Alimentadores

350 mA	on/off	dimmable
AL1034 (1.3/1)	30mm IP20	AL4000 (1.4/1.2)
AL1035 (1.3/1)	40mm IP20	AL4051 (1.4/1.2)
AL1037 (1.5/1.2)	55mm IP20 S.P.	AL4053 (1.4/1.2)
AL9011 (1.4/1.2)	44mm IP67	AL8035 (2.4/1.2)

500 mA	on/off	dimmable
AL1074 (1.2/1)	30mm IP20	AL4010 (1.4/1.2)
AL1077 (1.2/1)	40mm IP20	AL4151 (1.4/1.2)
AL1084 (1.3/1)	55mm IP20 S.P.	AL4153 (1.4/1.2)
AL9051 (1.3/1)	44mm IP67	AL8050 (2.4/1.2)

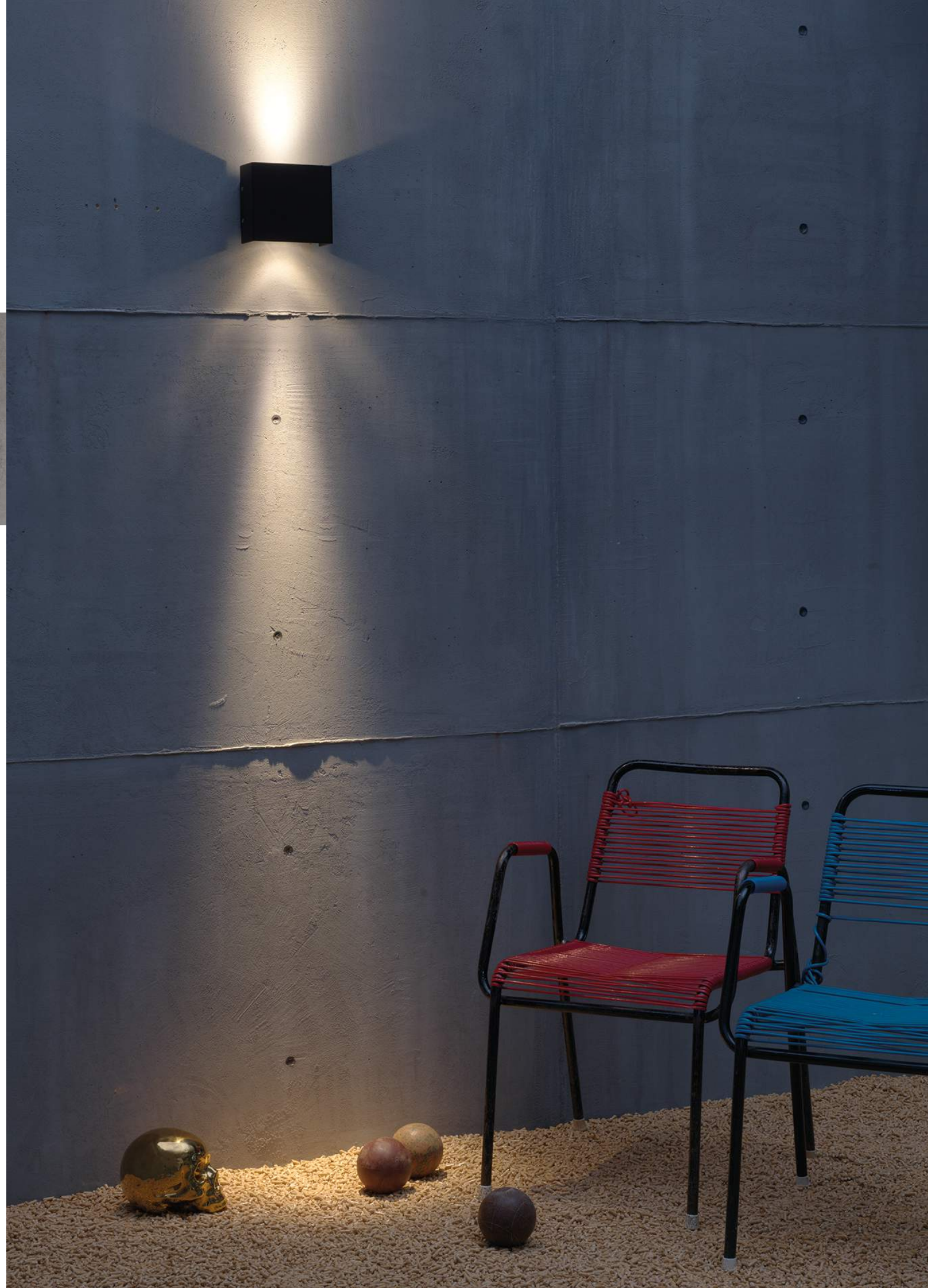

PUCK

design: Roberto Mantovani

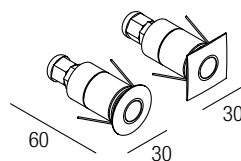

Supply current

Alimentazione
Courant d'alimentation
Stromversorgung
Corriente de alimentación
350 mA (V, 2.9V)

Power

Potenza
Puissance
Bestuekung
Potencia
1 W

Series wiring

Cablaggio in serie
Câblage en série
Verkabelung in Serie
Cableado en serie



CCT/CRI/Flux

2700K — 101 lm
3000K — 109 lm
4200K — 116 lm
6000K — 132 lm

CRI85

2-Step MacAdam

Photometric diagrams

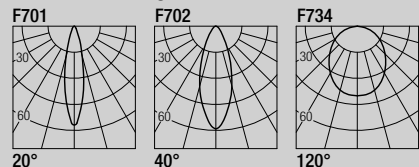

Code Construction

Costruzione del codice - Construction du code produit
Bau der Produkt-Code - Construcción del código de producto

PK X X X X

Finishing

	B	G	N	K	Z
Finitura	White	Grey	Black	COR-TEN	INOX AISI 316L
Finitions	Bianco	Grigio	Nero		Steel
Oberflächenfinish	Blanc	Gris	Noir		Acciaio
Acabados	Weiß	Grau	Schwarz		Acier
	Blanco		Negro		Stahl
					Acero

Color Temperature

	0	1	2	3	6	7	8
Temperatura colore	2700K	3000K	4200K	6000K	Blue	Green	Red
Température couleur					Blu	Verde	Rosso
Temperaturabhängige Farbe					Bleu	Vert	Rouge
Temperatura de color					Blau	Grün	Rojo
					Azul		

Beam angle

	1	2	9
Apertura di fascio	20°	40°	120°
Angle de faisceau			
Strahlwinkel			
Ángulo del haz			

Shape

	1	2
Forma	Round	Square
Forme	Tondo	Quadro
Form	Ronde	Carré
	Runde	Quadrat
	Redondo	Cuadrado

Accessories

Accessori - Accessoires
Zubehör - Accesorios

CSTY01

Recessing box
Controcassa
Boîtier d'encastrement
Eingießerhäuse
Caja de empotrar

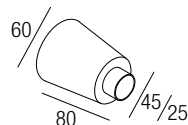

Drivers

Alimentatori - Alimentateurs
Netzteile - Alimentadores

350 mA	on/off	dimmable
AL1034 (1.11)	30mm IP20	AL4000 (1.12)
AL1035 (1.11)	40mm IP20	72mm IP20 PUSH 0/1..10V
AL1037 (1.16)	55mm IP20 S.P.	AL4051 (2.14)
AL9011 (1.12)	44mm IP67	72mm IP20 DALI 2
		AL4053 (1.14)
		56mm IP20 PUSH IGBT-TRIAC
		AL8035 (4.16)
		IP67 DALI



TYTUS

design: Roberto Mantovani

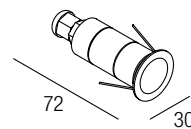

Supply current

Alimentazione
Courant d'alimentation
Stromversorgung
Corriente de alimentación
350 mA (V, 2,9V)

Power

Potenza
Puissance
Bestuekung
Potencia
1 W

Series wiring

Cablaggio in serie
Câblage en série
Verkabelung in Serie
Cableado en serie



CCT/CRI/Flux

2700K — 101 lm
3000K — 109 lm
4200K — 116 lm
6000K — 132 lm

CRI85

2-Step MacAdam

Photometric diagrams

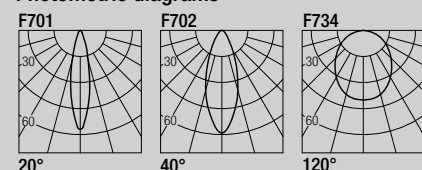

Code Construction

Costruzione del codice - Construction du code produit
Bau der Produkt-Code - Construcción del código de producto

TYU X.X.X

Finishing	B	G	N	K
Finitura	White	Grey	Black	COR-TEN
Finitions	Bianco	Grigio	Nero	
Oberflächenfinish	Blanc	Gris	Noir	
Acabados	Weiß	Grau	Schwarz	
	Blanco		Negro	

Color Temperature	0	1	2	3	6	7	8
Temperatura colore	2700K	3000K	4200K	6000K	Blue	Green	Red
Température couleur					Bleu	Vert	Rouge
Temperaturabhängige Farbe					Blau	Grün	Rot
Temperatura de color					Azul		Rojo

Beam angle	1	2	9
Apertura di fascio	20°	40°	120°
Angle de faisceau			
Strahlwinkel			
Ángulo del haz			

Drivers

Alimentatori - Alimentateurs
Netzteile - Alimentadores

350 mA	on/off	dimmable
AL1034 (1..11)	30mm IP20	AL4000 (1..12)
AL1035 (1..11)	40mm IP20	AL4051 (2..14)
AL1037 (1..16)	55mm IP20 S.P.	AL4053 (1..14)
AL9011 (1..12)	44mm IP67	AL8035 (4..16)
		IP67 DALI



TYZAN

design: Roberto Mantovani

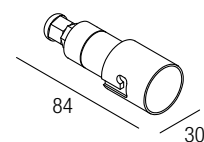

Supply current

Alimentazione
Courant d'alimentation
Stromversorgung
Corriente de alimentación
350 mA (V_i 2,9V)

Power

Potenza
Puissance
Bestuekung
Potencia
1 W

Series wiring

Cablaggio in serie
Câblage en série
Verkabelung in Serie
Cableado en serie

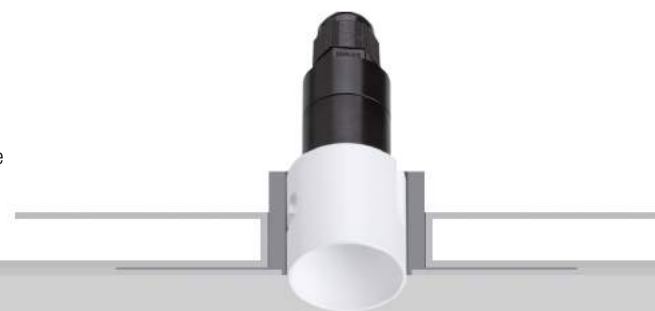

CCT/CRI/Flux

2700K — **101 lm**
3000K — **109 lm**
4200K — **116 lm**
6000K — **132 lm**

CRI85

2-Step MacAdam

Photometric diagrams

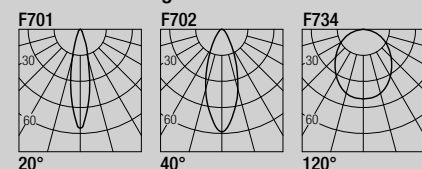

Code Construction

Costruzione del codice - Construction du code produit
Bau der Produkt-Code - Construcción del código de producto

TZ | **X** | **X** | **X** |

Finishing

Finitura
Finitions
Oberflächenfinish
Acabados

B | **N**

White | Black
Bianco | Nero
Blanc | Noir
Weiß | Schwarz
Blanco | Negro

Color Temperature

Temperatura colore
Température couleur
Temperaturabhängige Farbe
Temperatura de color

0 | **1** | **2** | **3** | **6** | **7** | **8**

2700K | 3000K | 4200K | 6000K | Blue | Green | Red
Blu | Verde | Rosso
Bleu | Vert | Rouge
Blau | Grün | Rot
Azul | Rojo

Beam angle

Apertura di fascio
Angle de faisceau
Strahlwinkel
Ángulo del haz

1 | **2** | **9**

20° | 40° | 120°

Accessories

Accessori - Accessoires
Zubehör - Accesorios

ZQC001 ZQC001B

White | Black
Bianco | Nero
Blanc | Noir
Weiß | Schwarz
Blanco | Negro

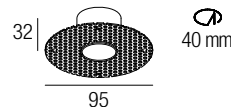

Plasterboard recessing frame
Flangia per cartongesso
Boîtier d'encastrement pour plaques de plâtre
Gehäuses Trockenbau
Cajetín para placas de yeso

Drivers

Alimentatori - Alimentateurs
Netzteile - Alimentadores

350 mA	on/off	dimmable
AL1034 (1..11)	30mm IP20	AL4000 (1..12)
AL1035 (1..11)	40mm IP20	AL4051 (2..14)
AL1037 (1..16)	50mm IP20 S.P.	AL4053 (1..14)
AL9011 (1..12)	44mm IP67	AL8035 (4..16)
		IP20 PUSH 0/1..10V
		IP20 DALI 2
		IP20 PUSH IGBT-TRIAC
		IP67 DALI



HANS

design: Roberto Mantovani

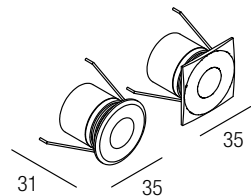

Supply current

Alimentazione
Courant d'alimentation
Stromversorgung
Corriente de alimentación

350 mA (V, 2,9V)

Power

Potenza
Puissance
Bestuekung
Potencia

1 W

Series wiring

Cablaggio in serie
Câblage en série
Verkabelung in Serie
Cableado en serie



CCT/CRI/Flux

2700K	101 lm
3000K	109 lm
4200K	116 lm
6000K	132 lm

CRI85

2-Step MacAdam

Photometric diagrams

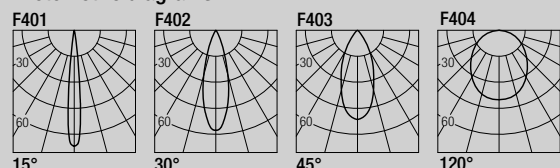

Code Construction

Costruzione del codice - Construction du code produit
Bau der Produkt-Code - Construcción del código de producto

HA X X X X

Finishing

Finitura
Finitions
Oberflächenfinish
Acabados

	B	G	N	K	Z
White	White	Grey	Black	COR-TEN	INOX AISI 316L
Bianco	Bianco	Grigio	Nero		Steel
Blanc	Blanc	Gris	Noir		Acciaio
Weiß	Weiß	Grau	Schwarz		Stahl
Blanco	Blanco	Negro	Negro		Acero

Color Temperature

	0	1	2	3	6	7	8
Temperatura colore	2700K	3000K	4200K	6000K	Blue	Green	Red
Température couleur					Blu	Verde	Rosso
Temperaturabhängige Farbe					Bleu	Vert	Rouge
Temperatura de color					Blau	Grün	Rot
					Azul		Rojo

Beam angle

	1	2	3	9
Apertura di fascio	15°	30°	45°	120°
Angle de faisceau				
Strahlwinkel				
Ángulo del haz				

Shape

	1	2
Forma	Round	Square
Forme	Tondo	Quadro
Form	Ronde	Carré
	Runde	Quadrat
	Redondo	Cuadrado

Note: cable cut to measure on request

Nota: cavo a misura disponibile su richiesta

Note: câble sur mesure disponible sur demande

Anmerkung: kundenspezifisches Kabel auf Anfrage erhältlich

Nota: cable a medida disponible a petición

Accessories

Accessori - Accessoires
Zubehör - Accesorios

CSLN01

Recessing box
Controcassa
Boîtier d'encastrement
Eingießgehäuse
Caja de empotrar

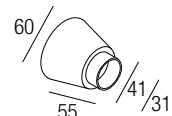

LHA01

Low luminance louver
Filtro antiabbagliamento
Filtre basse luminance
Geringe Leuchtdichte-Filter
Filtro de baja luminancia



Note: the filter must be ordered together with the lighting fixture - Nota: il filtro deve essere ordinato congiuntamente all'apparecchio - Note: le filtre doit être commandé en même temps que l'appareil - Anmerkung: muss der Filter zusammen mit Leuchtkörper bestellt werden
Nota: el filtro debe pedirse junto con la luminaria

Drivers

Alimentatori - Alimentateurs
Netzteile - Alimentadores

350 mA	on/off	dimnable
AL1034 (1..11)	30mm IP20	AL4000 (1..12)
AL1035 (1..11)	40mm IP20	72mm IP20 PUSH 0/1..10V
AL1037 (1..16)	55mm IP20 S.P.	AL4051 (2..14)
AL9011 (1..12)	44mm IP67	72mm IP20 DALI 2
		AL4053 (1..14)
		56mm IP20 PUSH IGBT-TRIAC
		AL8035 (4..16)
		IP67 DALI



LOTUS 2

design: Roberto Mantovani

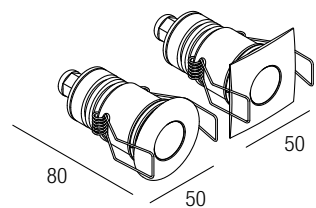

Supply current
Alimentazione
Courant d'alimentation
Stromversorgung
Corriente de alimentación
350-500 mA (V, 2,9V)

Power
Potenza
Puissance
Bestuekung
Potencia
1-2 W

Series wiring
Cablaggio in serie
Câblage en série
Verkabelung in Serie
Cableado en serie



Photometric diagrams

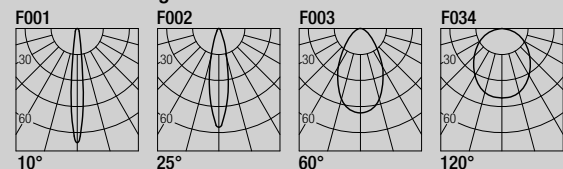

CCT/CRI/Flux	350mA	500mA
2700K	89 lm	128 lm
3000K	93 lm	133 lm
4200K	103 lm	154 lm
6000K	114 lm	165 lm

CRI85
2-Step MacAdam

Code Construction

Costruzione del codice - Construction du code produit
Bau der Produkt-Code - Construcción del código de producto

LT1 X X X X

Finishing	B	G	N	K	Z		
Finitura Finitions Oberflächenfinish Acabados	White Bianco Blanc Weiß Blanco	Grey Grigio Gris Grau	Black Nero Noir Schwarz Negro	COR-TEN	INOX AISI 316L Steel Acciaio Acier Stahl Acero		
Color Temperature	0	1	2	3	6	7	8
Temperatura colore Température couleur Temperaturabhängige Farbe Temperatura de color	2700K	3000K	4200K	6000K	Blue Blu Bleu Blau Azul	Green Verde Vert Grün	Red Rosso Rouge Rot Rojo
Beam angle	0	1	2	9			
Apertura di fascio Angle de faisceau Strahlwinkel Ángulo del haz	10°	25°	60°	120°			
Shape	1	2					
Forma Forme Form	Round Tondo Ronde Runde Redondo	Square Quadro Carré Quadrat Cuadrado					

Accessories

Accessori - Accessoires
Zubehör - Accesorios

CSXT01

Recessing box
Controcassa
Boîtier d'encastrement
Eingießgehäuse
Caja de empotrar

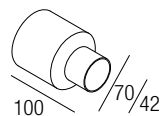

LLT101

Low luminance louver
Filtro antiabbagliamento
Filtre basse luminance
Geringe Leuchtdichte-Filter
Filtro de baja luminancia

Note: the filter must be ordered together with the lighting fixture - **Nota:** il filtro deve essere ordinato congiuntamente all'apparecchio - **Note:** le filtre doit être commandé en même temps que l'appareil - **Anmerkung:** muss der Filter zusammen mit Leuchtkörper bestellt werden
Nota: el filtro debe pedirse junto con la luminaria

Drivers

Alimentatori - Alimentateurs
Netzteile - Alimentadores

350 mA	on/off	dimmable	500 mA	on/off	dimmable
AL1034 (1.11)	30mm IP20	AL4000 (1.12)	72mm IP20 PUSH 0/1..10V	AL1074 (1.7)	30mm IP20
AL1035 (1.11)	40mm IP20	AL4051 (2.14)	72mm IP20 DALI 2	AL1077 (1.6)	40mm IP20
AL1037 (1.16)	50mm IP20 S.P.	AL4053 (1.14)	50mm IP20 PUSH IGBT-TRIAC	AL1084 (1.11)	50mm IP20 S.P.
AL9011 (1.12)	44mm IP67	AL8035 (4.16)	IP67 DALI	AL9051 (1.11)	44mm IP67
				AL4010 (1.12)	72mm IP20 PUSH 0/1..10V
				AL4151 (2.14)	72mm IP20 DALI 2
				AL4153 (1.14)	50mm IP20 PUSH IGBT-TRIAC
				AL8050 (4.16)	IP67 DALI

LOTUS 6

design: Roberto Mantovani

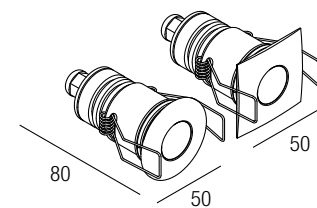

Supply current
Alimentazione
Courant d'alimentation
Stromversorgung
Corriente de alimentación
350-500 mA (V, 8,7V)

Power
Potenza
Puissance
Bestuekung
Potencia
3-6 W

Series wiring
Cablaggio in serie
Câblage en série
Verkabelung in Serie
Cableado en serie



Photometric diagrams

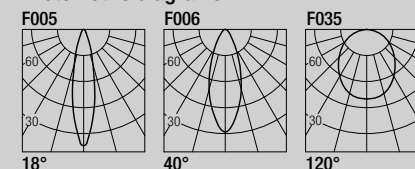

CCT/CRI/Flux	350mA	500mA
2700K	267 lm	384 lm
3000K	279 lm	400 lm
4200K	309 lm	462 lm
6000K	342 lm	495 lm

CRI85
2-Step MacAdam

Code Construction

Costruzione del codice - Construction du code produit
Bau der Produkt-Code - Construcción del código de producto

LT2 X X X X

Finishing	B	G	N	K	Z		
Finitura Finitions Oberflächenfinish Acabados	White Bianco Blanc Weiß Blanco	Grey Grigio Gris Grau	Black Nero Noir Schwarz Negro	COR-TEN	INOX AISI 316L Steel Acciaio Acier Stahl Acero		
Color Temperature	0	1	2	3	6	7	8
Temperatura colore Température couleur Temperaturabhängige Farbe Temperatura de color	2700K	3000K	4200K	6000K	Blue Blu Bleu Blau Azul	Green Verde Vert Grün	Red Rosso Rouge Rot Rojo
Beam angle	1	2	9				
Apertura di fascio Angle de faisceau Strahlwinkel Ángulo del haz	18°	40°	120°				
Shape	1	2					
Forma Forme Form	Round Tondo Ronde Runde Redondo	Square Quadro Carré Quadrat Cuadrado					

Accessories

Accessori - Accessoires
Zubehör - Accesorios

CSXT01

Recessing box
Controcassa
Boîtier d'encastrement
Eingießgehäuse
Caja de empotrar

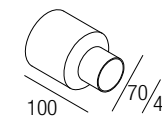

LLT201

Low luminance louver
Filtro antiabbagliamento
Filtre basse luminance
Geringe Leuchtdichte-Filter
Filtro de baja luminancia

Note: the filter must be ordered together with the lighting fixture - **Nota:** il filtro deve essere ordinato congiuntamente all'apparecchio - **Note:** le filtre doit être commandé en même temps que l'appareil - **Anmerkung:** muss der Filter zusammen mit Leuchtkörper bestellt werden
Nota: el filtro debe pedirse junto con la luminaria

Drivers

Alimentatori - Alimentateurs
Netzteile - Alimentadores

350 mA	on/off	dimmable	500 mA	on/off	dimmable
AL1034 (1.3)	30mm IP20	AL4000 (1.4)	72mm IP20 PUSH 0/1..10V	AL1074 (1.2)	30mm IP20
AL1035 (1.3)	40mm IP20	AL4051 (1.4)	72mm IP20 DALI 2	AL1077 (1.2)	40mm IP20
AL1037 (1.5)	50mm IP20 S.P.	AL4053 (1.4)	50mm IP20 PUSH IGBT-TRIAC	AL1084 (1.3)	50mm IP20 S.P.
AL9011 (1.4)	44mm IP67	AL8035 (2.4)	IP67 DALI	AL9051 (1.3)	44mm IP67
				AL4010 (1.4)	72mm IP20 PUSH 0/1..10V
				AL4151 (1.4)	72mm IP20 DALI 2
				AL4153 (1.4)	50mm IP20 PUSH IGBT-TRIAC
				AL8050 (2.4)	IP67 DALI

LOTUS 6 EVO

design: Roberto Mantovani

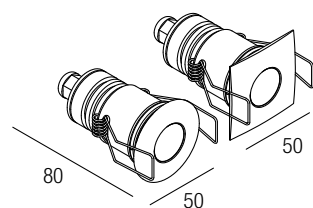

Supply current

Alimentazione
 Courant d'alimentation
 Stromversorgung
 Corriente de alimentación
500 mA (V_r 9V)

Power

Potenza
 Pouissance
 Bestuekung
 Potencia
6 W

Series wiring

Cablaggio in serie
 Câblage en série
 Verkabelung in Serie
 Cableado en serie



CCT/CRI/Flux

2700K — 540 lm
 3000K — 600 lm
 4000K — 620 lm

Photometric diagrams

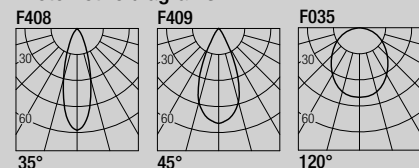

CRI98

2-Step MacAdam

Code Construction

Costruzione del codice - Construction du code produit
 Bau der Produkt-Code - Construcción del código de producto

LTE **X X X X**

Finishing

	B	G	N	K	Z
Finitura Finitions Oberflächenfinish Acabados	White Bianco Blanc Weiß Blanco	Grey Grigio Gris Grau	Black Nero Noir Schwarz Negro	COR-TEN	INOX AISI 316L Steel Acciaio Acier Stahl Acero

Color Temperature

	2	3	4
Temperatura colore Température couleur Temperaturabhängige Farbe Temperatura de color	2700K	3000K	4000K

Beam angle

	S	M	W
Apertura di fascio Angle de faisceau Strahlwinkel Ángulo del haz	35°	45°	120°

Shape

	1	2
Forma Forme Form	Round Tondo Ronde Runde Redondo	Square Quadro Carré Quadrat Cuadrado

Accessories

Accessori - Accessoires
 Zubehör - Accesorios

CSXT01

Recessing box
 Controcassa
 Boîtier d'encastrement
 Eingieβgehäuse
 Caja de empotrar

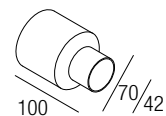

LLTE01

Low luminance louver
 Filtro antiabbagliamento
 Filtre basse luminance
 Geringe Leuchtdichte-Filter
 Filtro de baja luminancia

Note: the filter must be ordered together with the lighting fixture - **Nota:** il filtro deve essere ordinato congiuntamente all'apparecchio - **Note:** le filtre doit être commandé en même temps que l'appareil - **Anmerkung:** muss der Filter zusammen mit Leuchtkörper bestellt werden
Nota: el filtro debe pedirse junto con la luminaria

Drivers

Alimentatori - Alimentateurs
 Netzteile - Alimentadores

500 mA	on/off	dimmable	
AL1074 (1.2)	30mm IP20	AL4010 (1.4)	72mm IP20 PUSH 0/1..10V
AL1077 (1.2)	40mm IP20	AL4151 (1.4)	72mm IP20 DALI 2
AL1084 (1.3)	55mm IP20 S.P.	AL4153 (1.4)	56mm IP20 PUSH IGBT-TRIAC
AL9051 (1.3)	44mm IP67	AL8050 (2.4)	IP67 DALI



BABUS 2

design: Roberto Mantovani

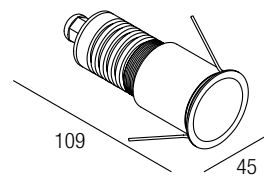

Supply current

Alimentazione
Courant d'alimentation
Stromversorgung
Corriente de alimentación
350-500 mA (V, 2,9V)

Power

Potenza
Puissance
Bestuekung
Potencia
1-2 W

Series wiring

Cablaggio in serie
Câblage en série
Verkabelung in Serie
Cableado en serie

CCT/CRI/Flux

	350mA	500mA
2700K	89 lm	128 lm
3000K	93 lm	133 lm
4200K	103 lm	154 lm
6000K	114 lm	165 lm

CRI85

2-Step MacAdam



Photometric diagrams

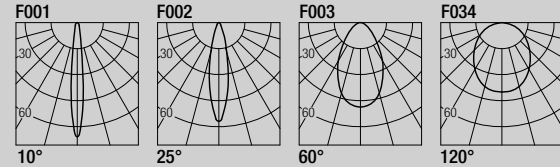

Code Construction

Costruzione del codice - Construction du code produit
Bau der Produkt-Code - Construcción del código de producto

BT1, X, X, X

Finishing

	B	G	N	K
Finitura Finitions Oberflächenfinish Acabados	White Bianco Blanc Weiß Blanco	Grey Grigio Gris Grau	Black Nero Noir Schwarz Negro	COR-TEN

Color Temperature

	0	1	2	3	6	7	8
Temperatura colore Température couleur Temperaturabhängige Farbe Temperatura de color	2700K	3000K	4200K	6000K	Blue Bleu Blau Azul	Green Vert Grün	Red Rosso Rouge Rojo

Beam angle

	0	1	2	9
Apertura di fascio Angle de faisceau Strahlwinkel Ángulo del haz	10°	25°	60°	120°

Drivers

Alimentatori - Alimentateurs
Netzteile - Alimentadores

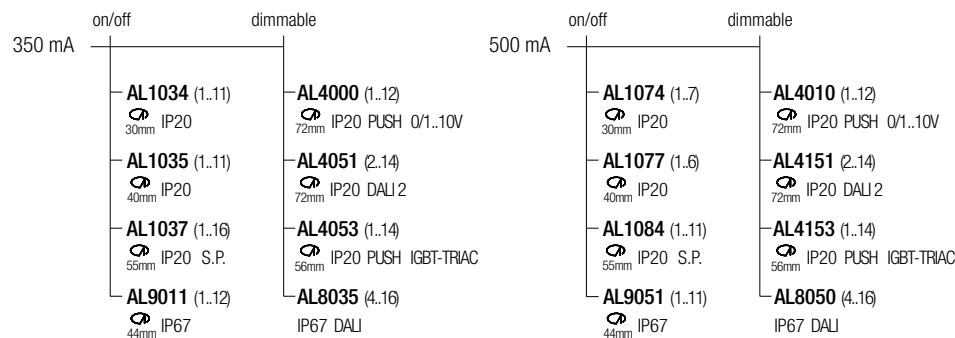

BABUS 6

design: Roberto Mantovani

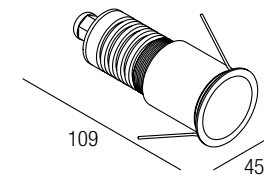

Supply current

Alimentazione
Courant d'alimentation
Stromversorgung
Corriente de alimentación
350-500 mA (V, 8,7V)

Power

Potenza
Puissance
Bestuekung
Potencia
3-6 W

Series wiring

Cablaggio in serie
Câblage en série
Verkabelung in Serie
Cableado en serie



Photometric diagrams

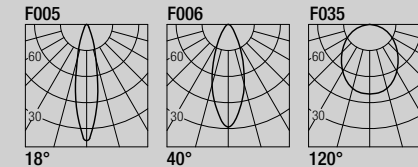

CCT/CRI/Flux

	350mA	500mA
2700K	267 lm	384 lm
3000K	279 lm	400 lm
4200K	309 lm	462 lm
6000K	342 lm	495 lm

CRI85

2-Step MacAdam

Code Construction

Costruzione del codice - Construction du code produit
Bau der Produkt-Code - Construcción del código de producto

BT2, X, X, X

Finishing

	B	G	N	K
Finitura Finitions Oberflächenfinish Acabados	White Bianco Blanc Weiß Blanco	Grey Grigio Gris Grau	Black Nero Noir Schwarz Negro	COR-TEN

Color Temperature

	0	1	2	3	6	7	8
Temperatura colore Température couleur Temperaturabhängige Farbe Temperatura de color	2700K	3000K	4200K	6000K	Blue Bleu Blau Azul	Green Vert Grün	Red Rosso Rouge Rojo

Beam angle

	1	2	9
Apertura di fascio Angle de faisceau Strahlwinkel Ángulo del haz	18°	40°	120°

Drivers

Alimentatori - Alimentateurs
Netzteile - Alimentadores

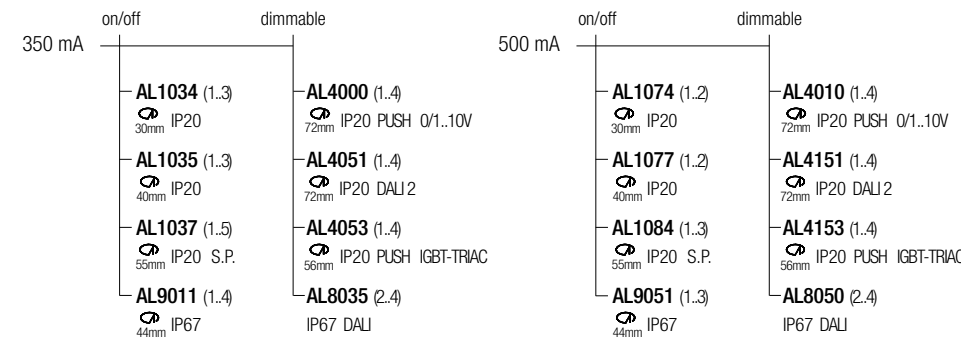

Accessories

Accessori - Accessoires
Zubehör - Accesorios

CSBU01

Recessing box
Controcassa
Boîtier d'encastrement
Eingießgehäuse
Caja de empotrar

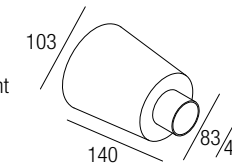

LBT201

Low luminance louver
Filtro antiabbagliamento
Filtre basse luminance
Geringe Leuchtdichte-Filter
Filtro de baja luminancia



Note: the filter must be ordered together with the lighting fixture - **Nota:** il filtro deve essere ordinato congiuntamente all'apparecchio - **Note:** le filtre doit être commandé en même temps que l'appareil - **Anmerkung:** muss der Filter zusammen mit Leuchtkörper bestellt werden
Nota: el filtro debe pedirse junto con la luminaria

BABUS 6 EVO

design: Roberto Mantovani

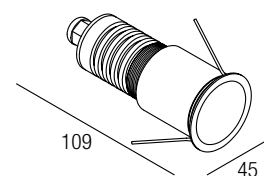

Supply current

Alimentazione
Courant d'alimentation
Stromversorgung
Corriente de alimentación
500 mA (V, 9V)

Power

Potenza
Puissance
Bestuekung
Potencia
6 W

Series wiring

Cablaggio in serie
Câblage en série
Verkabelung in Serie
Cableado en serie



CCT/CRI/Flux

2700K — **540 lm**
3000K — **600 lm**
4000K — **620 lm**

Photometric diagrams

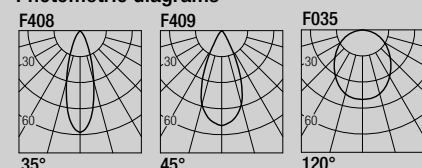

CRI98

2-Step MacAdam

Code Construction

Costruzione del codice - Construction du code produit
Bau der Produkt-Code - Construcción del código de producto

BTE X,X,X

Finishing

	B	G	N	K
Finitura	White	Grey	Black	COR-TEN
Finitions	Bianco	Grigio	Nero	
Oberflächenfinish	Blanc	Gris	Noir	
Acabados	Weiß	Grau	Schwarz	
	Blanco		Negro	

Color Temperature

	2	3	4
Temperatura colore	2700K	3000K	4000K
Température couleur			
Temperaturabhängige Farbe			
Temperatura de color			

Beam angle

	S	M	W
Apertura di fascio	35°	45°	120°
Angle de faisceau			
Strahlwinkel			
Ángulo del haz			

Accessories

Accessori - Accessoires
Zubehör - Accesorios

CSBU01

Recessing box
Controcassa
Boîtier d'encastrement
Eingieβgehäuse
Caja de empotrar

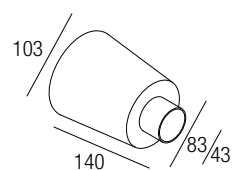

LBTE01

Low luminance louver
Filtro antiabbagliamento
Filtre basse luminance
Geringe Leuchtdichte-Filter
Filtro de baja luminancia



Note: the filter must be ordered together with the lighting fixture - **Nota:** il filtro deve essere ordinato congiuntamente all'apparecchio - **Note:** le filtre doit être commandé en même temps que l'appareil - **Anmerkung:** muss der Filter zusammen mit Leuchtkörper bestellt werden
Nota: el filtro debe pedirse junto con la luminaria

Drivers

Alimentatori - Alimentateurs
Netzteile - Alimentadores

500 mA	on/off	dimmable
AL1074 (1.2)	30mm IP20	AL4010 (1.4)
AL1077 (1.2)	40mm IP20	72mm IP20 PUSH 0/1..10V
AL1084 (1.3)	55mm IP20 S.P.	AL4151 (1.4)
AL9051 (1.3)	44mm IP67	72mm IP20 DALI 2
		AL4153 (1.4)
		56mm IP20 PUSH IGBT-TRIAC
		AL8050 (2.4)
		IP67 DALI



ZERUS 2

design: Roberto Mantovani

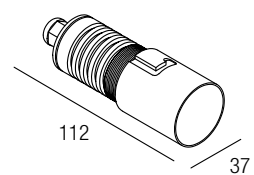

Supply current

Alimentazione
Courant d'alimentation
Stromversorgung
Corriente de alimentación

350-500 mA (V, 2,9V)

Power

Potenza
Puissance
Bestuekung
Potencia

1-2 W

Series wiring

Cablaggio in serie
Câblage en série
Verkabelung in Serie
Cableado en serie

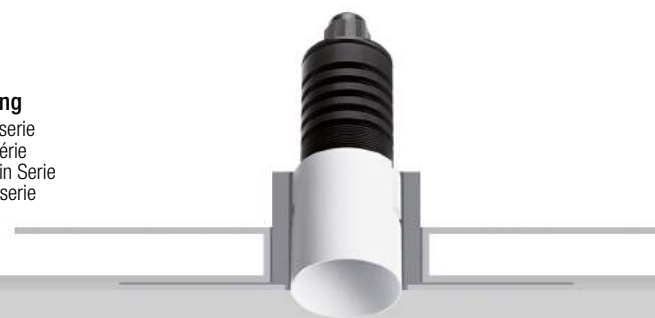

Photometric diagrams

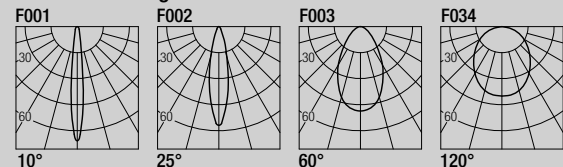

CCT/CRI/Flux

	350mA	500mA
2700K	89 lm	128 lm
3000K	93 lm	133 lm
4200K	103 lm	154 lm
6000K	114 lm	165 lm

CRI85

2-Step MacAdam

Code Construction

Costruzione del codice - Construction du code produit
Bau der Produkt-Code - Construcción del código de producto

ZT1 X X X

Finishing

Finitura
Finitions
Oberflächenfinish
Acabados

B N

White Black
Bianco Nero
Blanc Noir
Weiß Schwarz
Blanco Negro

Color Temperature

Temperatura colore
Température couleur
Temperaturabhängige Farbe
Temperatura de color

0 1 2 3 6 7 8

2700K 3000K 4200K 6000K Blue Green Red
Blu Verde Rosso
Bleu Vert Rouge
Blau Grün Rot
Azul Rojo

Beam angle

Apertura di fascio
Angle de faisceau
Strahlwinkel
Ángulo del haz

0 1 2 9

10° 25° 60° 120°

Accessories

Accessori - Accessoires
Zubehör - Accesorios

ZQT00U ZQT00UB

White Black
Bianco Nero
Blanc Noir
Weiß Schwarz
Blanco Negro

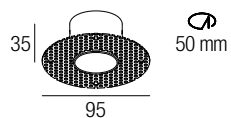

Plasterboard recessing frame
Flangia per cartongesso
Boîtier d'encastrement pour plaques de plâtre
Gehäuses Trockenbau
Cajetín para placas de yeso

LZT101

Low luminance louver
Filtro antiabbagliamento
Filtre basse luminance
Geringe Leuchtdichte-Filter
Filtro de baja luminancia

Note: the filter must be ordered together with the lighting fixture - **Nota:** il filtro deve essere ordinato congiuntamente all'apparecchio - **Note:** le filtre doit être commandé en même temps que l'appareil - **Anmerkung:** muss der Filter zusammen mit Leuchtkörper bestellt werden
Nota: el filtro debe pedirse junto con la luminaria

Drivers

Alimentatori - Alimentateurs
Netzteile - Alimentadores

350 mA		500 mA	
on/off	dimnable	on/off	dimnable
AL1034 (1..11) 30mm IP20	AL4000 (1..12) 72mm IP20 PUSH 0/1..10V	AL1074 (1..7) 30mm IP20	AL4010 (1..12) 72mm IP20 PUSH 0/1..10V
AL1035 (1..11) 40mm IP20	AL4051 (2..14) 72mm IP20 DALI 2	AL1077 (1..6) 40mm IP20	AL4151 (2..14) 72mm IP20 DALI 2
AL1037 (1..16) 55mm IP20 S.P.	AL4053 (1..14) 56mm IP20 PUSH IGBT-TRIAC	AL1084 (1..11) 55mm IP20 S.P.	AL4153 (1..14) 56mm IP20 PUSH IGBT-TRIAC
AL9011 (1..12) 44mm IP67	AL8035 (4..16) IP67 DALI	AL9051 (1..11) 44mm IP67	AL8050 (4..16) IP67 DALI



ZERUS 6

design: Roberto Mantovani

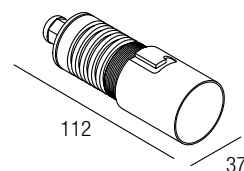

Supply current

Alimentazione
Courant d'alimentation
Stromversorgung
Corriente de alimentación

350-500 mA (V_i 8,7V)

Power

Potenza
Puissance
Bestuekung
Potencia

3-6 W

Series wiring

Cablaggio in serie
Câblage en série
Verkabelung in Serie
Cableado en serie

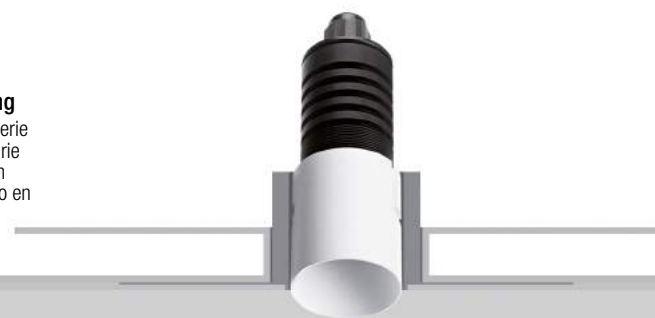

CCT/CRI/Flux

	350mA	500mA
2700K	267 lm	384 lm
3000K	279 lm	400 lm
4200K	309 lm	462 lm
6000K	342 lm	495 lm

CRI85

2-Step MacAdam

Photometric diagrams

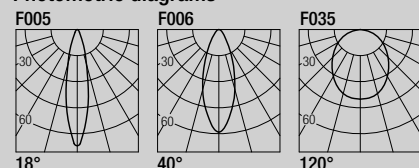

Code Construction

Costruzione del codice - Construction du code produit
Bau der Produkt-Code - Construcción del código de producto

ZT2 X X X

Finishing

Finitura
Finitions
Oberflächenfinish
Acabados

B N

White Bianco Blanc Weiß Blanco	Black Nero Noir Schwarz Negro
--	---

Color Temperature

0	1	2	3	6	7	8
2700K	3000K	4200K	6000K	Blue Bleu Blau Azul	Green Vert Grün	Red Rosso Rouge Rojo

Beam angle

1	2	9
18°	40°	120°

Drivers

Alimentatori - Alimentateurs
Netzteile - Alimentadores

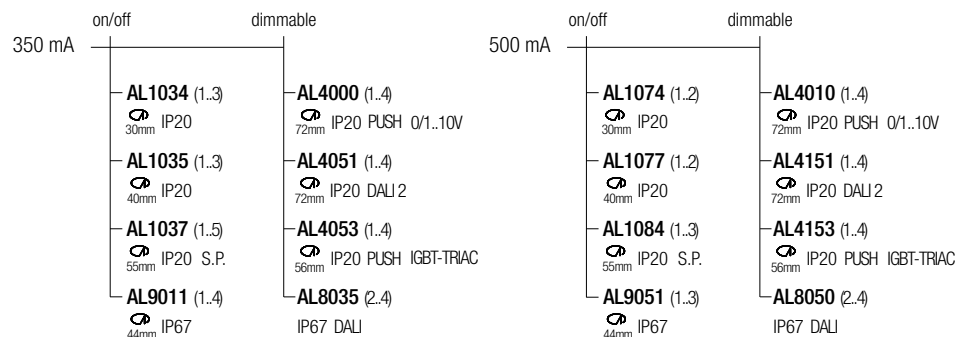

- DATASHEET ▶
- INSTALLATION MANUAL ▶
- CERTIFICATIONS ▶
- LDT-IES ▶
- DRAWINGS ▶

ZERUS 6 EVO

design: Roberto Mantovani

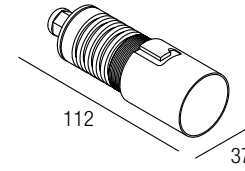

Supply current

Alimentazione
Courant d'alimentation
Stromversorgung
Corriente de alimentación

500 mA (V_i 9V)

Power

Potenza
Puissance
Bestuekung
Potencia

6 W

Series wiring

Cablaggio in serie
Câblage en série
Verkabelung in Serie
Cableado en serie



CCT/CRI/Flux

2700K	540 lm
3000K	600 lm
4000K	620 lm

CRI98

2-Step MacAdam

Photometric diagrams

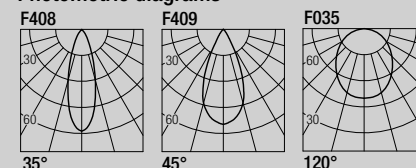

Code Construction

Costruzione del codice - Construction du code produit
Bau der Produkt-Code - Construcción del código de producto

ZTE X X X

Finishing

Finitura
Finitions
Oberflächenfinish
Acabados

B N

White Bianco Blanc Weiß Blanco	Black Nero Noir Schwarz Negro
--	---

Color Temperature

2	3	4
2700K	3000K	4000K

Beam angle

S	M	W
35°	45°	120°

Drivers

Alimentatori - Alimentateurs
Netzteile - Alimentadores

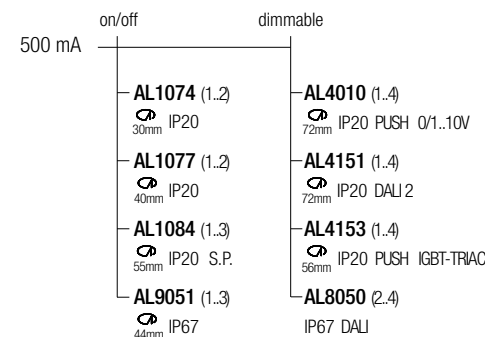

Accessories

Accessori - Accessoires
Zubehör - Accesorios

ZQT00U ZQT00UB

White Bianco Blanc Weiß Blanco	Black Nero Noir Schwarz Negro
--	---

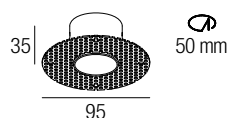

Plasterboard recessing frame
Flangia per cartongesso
Boîtier d'encastrement pour plaques de plâtre
Gehäuses Trockenbau
Cajetín para placas de yeso

LZT201

Low luminance louver
Filtro antiabbagliamento
Filtre basse luminance
Geringe Leuchtdichte-Filter
Filtro de baja luminancia



Note: the filter must be ordered together with the lighting fixture - **Nota:** il filtro deve essere ordinato congiuntamente all'apparecchio - **Note:** le filtre doit être commandé en même temps que l'appareil - **Anmerkung:** muss der Filter zusammen mit Leuchtkörper bestellt werden
Nota: el filtro debe pedirse junto con la luminaria

Accessories

Accessori - Accessoires
Zubehör - Accesorios

ZQT00U ZQT00UB

White Bianco Blanc Weiß Blanco	Black Nero Noir Schwarz Negro
--	---

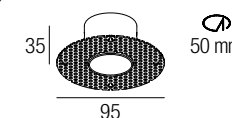

Plasterboard recessing frame
Flangia per cartongesso
Boîtier d'encastrement pour plaques de plâtre
Gehäuses Trockenbau
Cajetín para placas de yeso

LZTE01

Low luminance louver
Filtro antiabbagliamento
Filtre basse luminance
Geringe Leuchtdichte-Filter
Filtro de baja luminancia



Note: the filter must be ordered together with the lighting fixture - **Nota:** il filtro deve essere ordinato congiuntamente all'apparecchio - **Note:** le filtre doit être commandé en même temps que l'appareil - **Anmerkung:** muss der Filter zusammen mit Leuchtkörper bestellt werden
Nota: el filtro debe pedirse junto con la luminaria

FLY 6

design: Rod&Todd

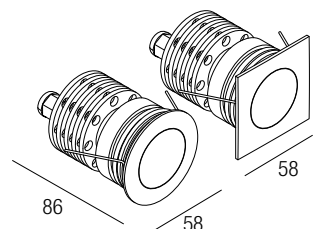

Supply current

Alimentazione
Courant d'alimentation
Stromversorgung
Corriente de alimentación
500 mA (V, 9V)

Power

Potenza
Puissance
Bestuekung
Potencia
6 W

Series wiring

Cablaggio in serie
Câblage en série
Verkabelung in Serie
Cableado en serie



CCT/CRI/Flux

2700K — 540 lm
3000K — 600 lm
4000K — 620 lm

CRI98
2-Step MacAdam

Photometric diagrams

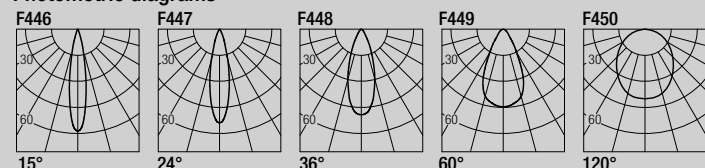

Code Construction

Costruzione del codice - Construction du code produit
Bau der Produkt-Code - Construcción del código de producto

FLY6 X X X X

Beam angle Apertura di fascio Angle de faisceau Strahlwinkel Ángulo del haz	N	S	M	W	X
	15°	24°	36°	60°	120°
Finishing Finitura Finitions Oberflächenfinish Acabados	B	G	N	K	Z
	White Bianco Blanc Weiß Blanco	Grey Grigio Gris Grau	Black Nero Noir Schwarz Negro	COR-TEN	INOX AISI 316L Steel Acciaio Stahl Acero
Color Temperature Temperatura colore Température couleur Temperaturabhängige Farbe Temperatura de color	2	3	4		
	2700K	3000K	4000K		
Shape Forma Forme Form	1	2			
	Round Tondo Ronde Runde Redondo	Square Quadro Carré Quadrat Cuadrado			

Accessories

Accessori - Accessoires
Zubehör - Accesorios

CSDS10

Recessing box
Controcassa
Boîtier d'encastrement
Eingießgehäuse
Caja de empotrar

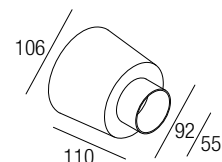

LFLY601

Low luminance louver
Filtro antiabbagliamento
Filtre basse luminance
Geringe Leuchtdichte-Filter
Filtro de baja luminancia



Note: the filter must be ordered together with the lighting fixture - **Nota:** il filtro deve essere ordinato congiuntamente all'apparecchio - **Note:** le filtre doit être commandé en même temps que l'appareil - **Anmerkung:** muss der Filter zusammen mit Leuchtkörper bestellt werden
Nota: el filtro debe pedirse junto con la luminaria

Drivers

Alimentatori - Alimentateurs
Netzteile - Alimentadores

on/off	dimnable
500 mA	
AL1074 (1..2) 30mm IP20	AL4010 (1..4) 72mm IP20 PUSH 0/1..10V
AL1077 (1..2) 40mm IP20	AL4151 (1..4) 72mm IP20 DALI 2
AL1084 (1..3) 55mm IP20 S.P.	AL4153 (1..4) 56mm IP20 PUSH IGBT-TRIAC
AL9051 (1..3) 44mm IP67	AL8050 (2..4) IP67 DALI



FLY 10

design: Rod&Todd

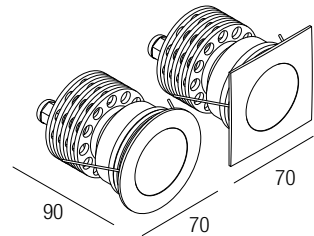

Supply current

Alimentazione
Courant d'alimentation
Stromversorgung
Corriente de alimentación
500 mA (V_i 18V)

Power

Potenza
Puissance
Bestuekung
Potencia
10 W

Series wiring

Cablaggio in serie
Câblage en série
Verkabelung in Serie
Cableado en serie

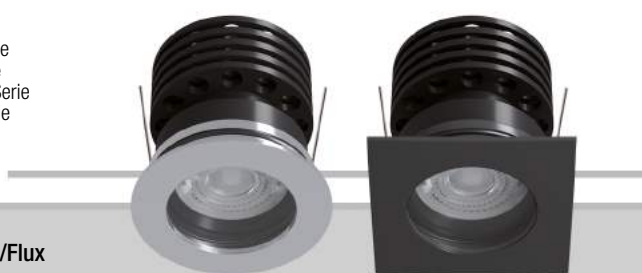

Photometric diagrams

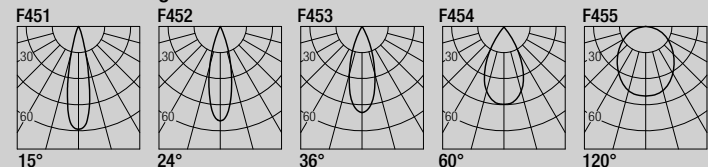

CCT/CRI/Flux

	CRI85	CRI93
2700K	890 lm	840 lm
3000K	1000 lm	930 lm
4000K	1040 lm	960 lm

CRI85 - CRI93
2-Step MacAdam

Code Construction

Costruzione del codice - Construction du code produit
Bau der Produkt-Code - Construcción del código de producto

FLY1 X X X X X

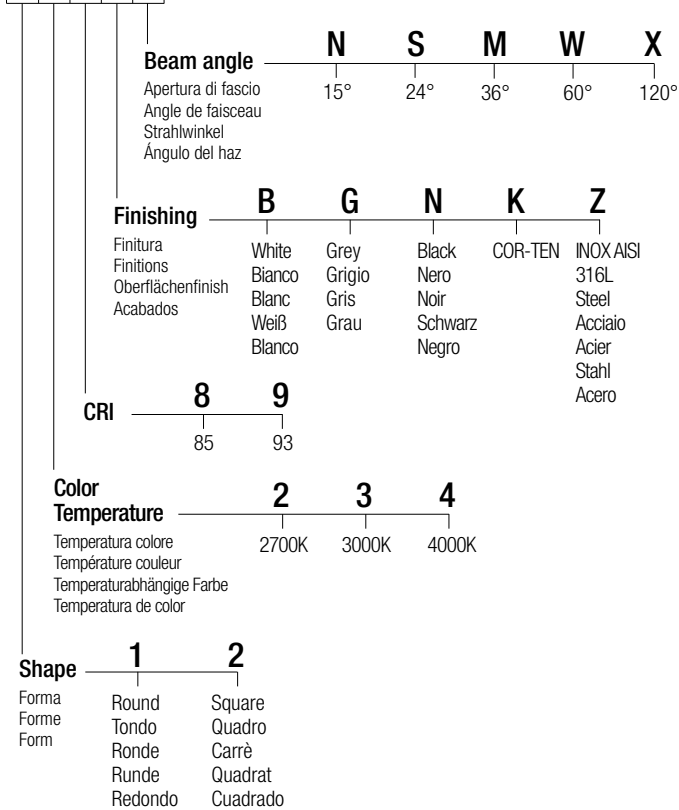

Accessories

Accessori - Accessoires
Zubehör - Accesorios

CSXJ01

Recessing box
Controcassa
Boîtier d'encastrement
Eingießgehäuse
Caja de empotrar

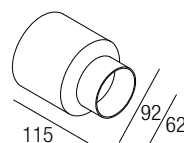

LFLY101

Low luminance louver
Filtro antiabbagliamento
Filtre basse luminance
Geringe Leuchtdichte-Filter
Filtro de baja luminancia



Note: the filter must be ordered together with the lighting fixture - **Nota:** il filtro deve essere ordinato congiuntamente all'apparecchio - **Note:** le filtre doit être commandé en même temps que l'appareil - **Anmerkung:** muss der Filter zusammen mit Leuchtkörper bestellt werden
Nota: el filtro debe pedirse junto con la luminaria

Drivers

Alimentatori - Alimentateurs
Netzteile - Alimentadores

on/off	dimmable
500 mA	
AL1074 (1) 30mm IP20	AL4010 (1..2) 72mm IP20 PUSH 0/1..10V
AL1077 (1) 40mm IP20	AL4151 (1..2) 72mm IP20 DALI2
AL1084 (1..2) 55mm IP20 S.P.	AL4153 (1..2) 56mm IP20 PUSH IGBT-TRAC
AL9051 (1..2) 44mm IP67	AL8050 (1..2) IP67 DALI

FLY 724

design: Rod&Todd

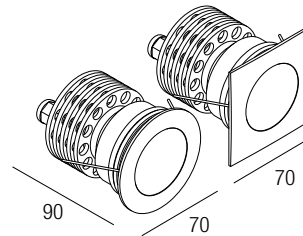

Supply current

Alimentazione
Courant d'alimentation
Stromversorgung
Corriente de alimentación
24 VDC

Power

Potenza
Puissance
Bestuekung
Potencia
7 W

Parallel wiring

Cablaggio in parallelo
Câblage en parallèle
Verkabelung in parallel
Cableado en paralelo

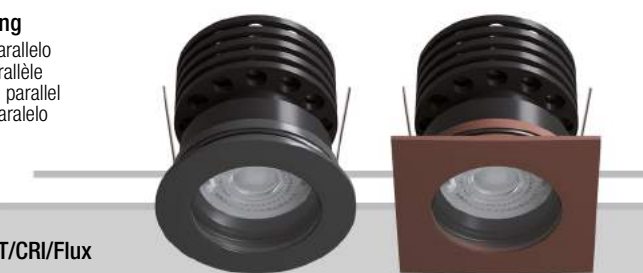

Photometric diagrams

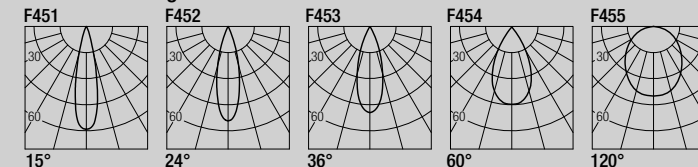

CCT/CRI/Flux

	CRI85	CRI93
2700K	630 lm	590 lm
3000K	700 lm	650 lm
4000K	730 lm	670 lm

CRI85 - CRI93
2-Step MacAdam

Code Construction

Costruzione del codice - Construction du code produit
Bau der Produkt-Code - Construcción del código de producto

FLY24 X X X X X

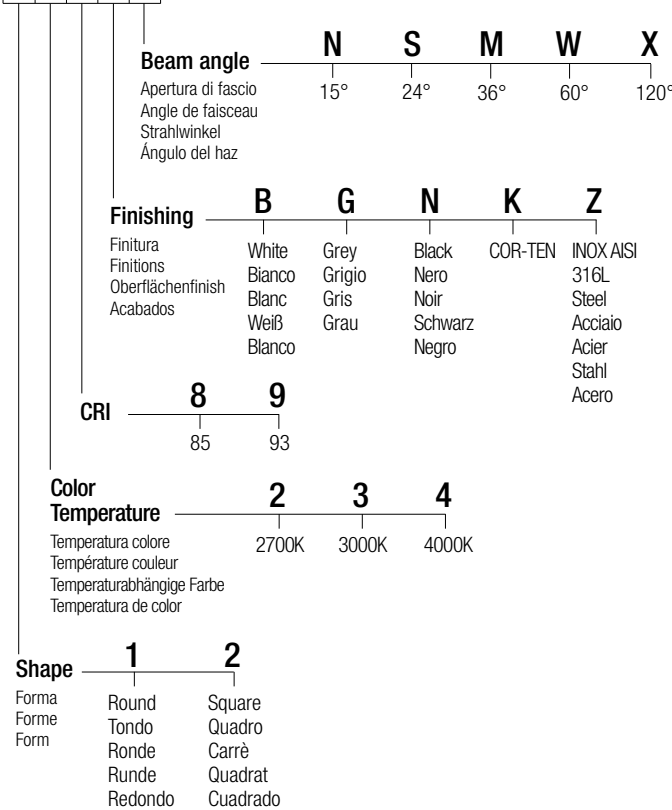

Accessories

Accessori - Accessoires
Zubehör - Accesorios

CSXJ01

Recessing box
Controcassa
Boîtier d'encastrement
Eingießgehäuse
Caja de empotrar

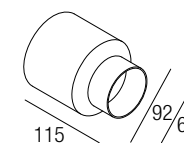

LFLY2401

Low luminance louver
Filtro antiabbagliamento
Filtre basse luminance
Geringe Leuchtdichte-Filter
Filtro de baja luminancia



Note: the filter must be ordered together with the lighting fixture - **Nota:** il filtro deve essere ordinato congiuntamente all'apparecchio - **Note:** le filtre doit être commandé en même temps que l'appareil - **Anmerkung:** muss der Filter zusammen mit Leuchtkörper bestellt werden
Nota: el filtro debe pedirse junto con la luminaria

Drivers

Alimentatori - Alimentateurs
Netzteile - Alimentadores

on/off	dimming module	dimmable
24 VDC		
AL2012 (1..3) 60mm IP20	AL7035 IP20 PUSH DALI 0/1..10V	AL5012 (1..3) 45mm IP20 PUSH DALI 0/1..10V
AL2031 (1..10) 70mm IP20		AL8012 (1..3) IP67 DALI
AL2040 (1..21) 80mm IP20		
AL9212 (1..2) 110mm IP67		
AL9231 (1..10) 85mm IP67		
AL9240 (1..21) 85mm IP67		

Note: dimming module AL7035 to be used in combination with an on/off 24VDC power supply
Nota: modulo di dimmerazione AL7035 da utilizzare in combinazione con un alimentatore on/off 24VDC
Note: module de variation AL7035 d'intensité à utiliser en combinaison avec une alimentation on/off 24VDC
Anmerkung: Dimmmodul AL7035 zur Verwendung in Kombination mit einem on/off 24VDC-Netzteil
Nota: módulo de regulación AL7035 se utiliza en combinación con una fuente de alimentación on/off 24VDC

ALPHA 2

design: Roberto Mantovani

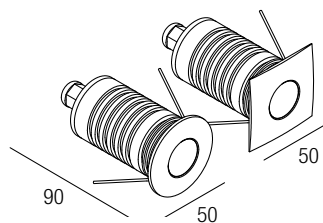

Supply current
 Alimentazione
 Courant d'alimentation
 Stromversorgung
 Corriente de alimentación
350-500 mA (V, 2,9V)

Power
 Potenza
 Pouissance
 Bestuekung
 Potencia
1-2 W

Series wiring
 Cablaggio in serie
 Câblage en série
 Verkabelung in Serie
 Cableado en serie



CCT/CRI/Flux

	350mA	500mA
2700K	89 lm	128 lm
3000K	93 lm	133 lm
4200K	103 lm	154 lm
6000K	114 lm	165 lm

CRI85 - CRI93

2-Step MacAdam

Photometric diagrams

F400

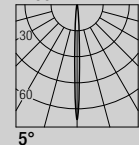

Code Construction

Costruzione del codice - Construction du code produit
 Bau der Produkt-Code - Construcción del código de producto

AP1 X X X 5

Beam angle 5°

Apertura di fascio 5°
 Angle de faisceau 5°
 Strahlwinkel 5°
 Ángulo del haz 5°

Color

Temperature

	0	1	2	3	6	7	8
Temperatura colore	2700K	3000K	4200K	6000K	Blue	Green	Red
Température couleur					Blu	Verde	Rosso
Temperaturabhängige Farbe					Bleu	Vert	Rouge
Temperatura de color					Blau	Grün	Rot
					Azul		Rojo

Finishing

	B	G	N	K	Z
Finitura	White	Grey	Black	COR-TEN	INOX AISI 316L
Finitions	Bianco	Grigio	Nero		Steel
Oberflächenfinish	Bianco	Gris	Noir		Acciaio
Acabados	Weiß	Grau	Schwarz		Acier
	Blanco		Negro		Stahl
					Acero

Shape

	1	2
Forma	Round	Square
Forme	Tondo	Quadro
Form	Ronde	Carré
	Runde	Quadrat
	Redondo	Cuadrado

Accessories

Accessori - Accessoires
 Zubehör - Accesorios

CSBU01

Recessing box
 Controcassa
 Boîtier d'encastrement
 Eingießgehäuse
 Caja de empotrar

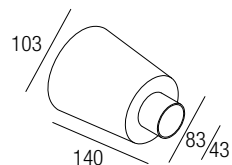

Drivers

Alimentatori - Alimentateurs
 Netzteile - Alimentadores

350 mA		500 mA	
on/off	dimmable	on/off	dimmable
AL1034 (1..11) 30mm IP20	AL4000 (1..12) 72mm IP20 PUSH 0/1..10V	AL1074 (1..7) 30mm IP20	AL4010 (1..12) 72mm IP20 PUSH 0/1..10V
AL1035 (1..11) 40mm IP20	AL4051 (2..14) 72mm IP20 DALI 2	AL1077 (1..6) 40mm IP20	AL4151 (2..14) 72mm IP20 DALI 2
AL1037 (1..16) 50mm IP20 S.P.	AL4053 (1..14) 56mm IP20 PUSH IGBT-TRIAC	AL1084 (1..11) 50mm IP20 S.P.	AL4153 (1..14) 56mm IP20 PUSH IGBT-TRIAC
AL9011 (1..12) 44mm IP67	AL8035 (4..16) IP67 DALI	AL9051 (1..11) 44mm IP67	AL8050 (4..16) IP67 DALI



ALPHA 10

design: Roberto Mantovani

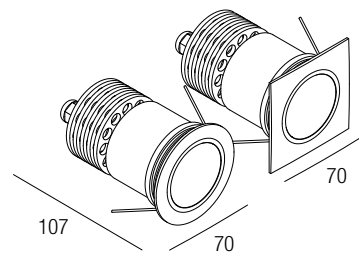

Supply current
 Alimentazione
 Courant d'alimentation
 Stromversorgung
 Corriente de alimentación
250 mA (V_i 36V)

Power
 Potenza
 Pouissance
 Bestuekung
 Potencia
10 W



Photometric diagrams

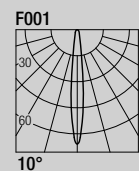

CCT/CRI/Flux

	CRI85	CRI93
2700K	890 lm	840 lm
3000K	1000 lm	930 lm
4000K	1040 lm	960 lm

CRI85 - CRI93
 2-Step MacAdam

Code Construction

Costruzione del codice - Construction du code produit
 Bau der Produkt-Code - Construcción del código de producto

AP2 X X X X 1

Beam angle 10°

Apertura di fascio 10°
 Angle de faisceau 10°
 Strahlwinkel 10°
 Ángulo del haz 10°

CRI **8** **9**
 85 93

Color Temperature **2** **3** **4**
 2700K 3000K 4000K
 Temperatura colore
 Température couleur
 Temperaturabhängige Farbe
 Temperatura de color

Finishing **B** **G** **N** **K** **Z**
 Finitura White Grey Black COR-TEN INOX AISI 316L
 Finitions Bianco Grigio Nero Acier Steel
 Oberflächenfinish Blanc Gris Noir Schwarz Acier
 Acabados Blanco Grau Schwarz Negro Stahl
 Acero

Shape **1** **2**
 Forma Round Square
 Forme Tondo Quadro
 Forme Ronde Carré
 Forme Runde Quadrat
 Forme Redondo Cuadrado

Accessories

Accessori - Accessoires
 Zubehör - Accesorios

CSXJ01

Recessing box
 Controcassa
 Boîtier d'encastrement
 Eingießgehäuse
 Caja de empotrar

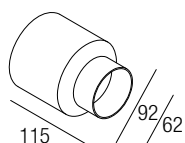

Drivers

Alimentatori - Alimentateurs
 Netzteile - Alimentadores

250 mA	on/off	dimmable
AL1025 (1)	AL4030 (1)	
40mm IP20	55mm IP20 0/1..10V	
AL9025 (1)	AL4031 (1)	
45mm IP67	55mm IP20 DALI	
	AL4032 (1)	
	55mm IP20 IGBT-TRIAC	



BETA 2

design: Roberto Mantovani

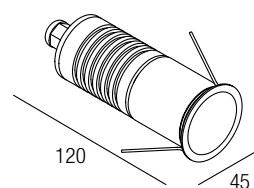

Supply current

Alimentazione
 Courant d'alimentation
 Stromversorgung
 Corriente de alimentación
350-500 mA (V, 2,9V)

Power

Potenza
 Pouissance
 Bestuekung
 Potencia
1-2 W

Series wiring

Cablaggio in serie
 Câblage en série
 Verkabelung in Serie
 Cableado en serie



CCT/CRI/Flux

	350mA	500mA
2700K	89 lm	128 lm
3000K	93 lm	133 lm
4200K	103 lm	154 lm
6000K	114 lm	165 lm

CRI85 - CRI93

2-Step MacAdam

Photometric diagrams

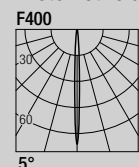

Code Construction

Costruzione del codice - Construction du code produit
 Bau der Produkt-Code - Construcción del código de producto

ET1 X X 5

Beam angle 5°

Apertura di fascio
 Angle de faisceau
 Strahlwinkel
 Ángulo del haz

Color Temperature

0	1	2	3	6	7	8
2700K	3000K	4200K	6000K	Blue	Green	Red
				Blu	Verde	Rosso
				Bleu	Vert	Rouge
				Blau	Grün	Rot
				Azul		Rojo

Finishing

B	G	N	K
White	Grey	Black	COR-TEN
Bianco	Grigio	Nero	
Blanc	Gris	Noir	
Weiß	Grau	Schwarz	
Blanco		Negro	

- DATASHEET ▶
- INSTALLATION MANUAL ▶
- CERTIFICATIONS ▶
- LDT-IES ▶
- DRAWINGS ▶

Accessories

Accessori - Accessoires
 Zubehör - Accesorios

CSBU01

Recessing box
 Controcassa
 Boîtier d'encastrement
 Eingieβgehäuse
 Caja de empotrar

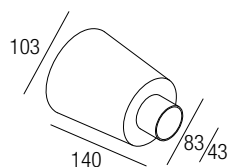

Drivers

Alimentatori - Alimentateurs
 Netzteile - Alimentadores

350 mA	500 mA
<ul style="list-style-type: none"> on/off AL1034 (1..11) 30mm IP20 AL1035 (1..11) 40mm IP20 AL1037 (1..16) 55mm IP20 S.P. AL9011 (1..12) 44mm IP67 	<ul style="list-style-type: none"> dimmable AL4000 (1..12) 72mm IP20 PUSH 0/1..10V AL4051 (2..14) 72mm IP20 DALI 2 AL4053 (1..14) 56mm IP20 PUSH IGBT-TRIAC AL8035 (4..16) IP67 DALI
<ul style="list-style-type: none"> on/off AL1074 (1..7) 30mm IP20 AL1077 (1..6) 40mm IP20 AL1084 (1..11) 55mm IP20 S.P. AL9051 (1..11) 44mm IP67 	<ul style="list-style-type: none"> dimmable AL4010 (1..12) 72mm IP20 PUSH 0/1..10V AL4151 (2..14) 72mm IP20 DALI 2 AL4153 (1..14) 56mm IP20 PUSH IGBT-TRIAC AL8050 (4..16) IP67 DALI

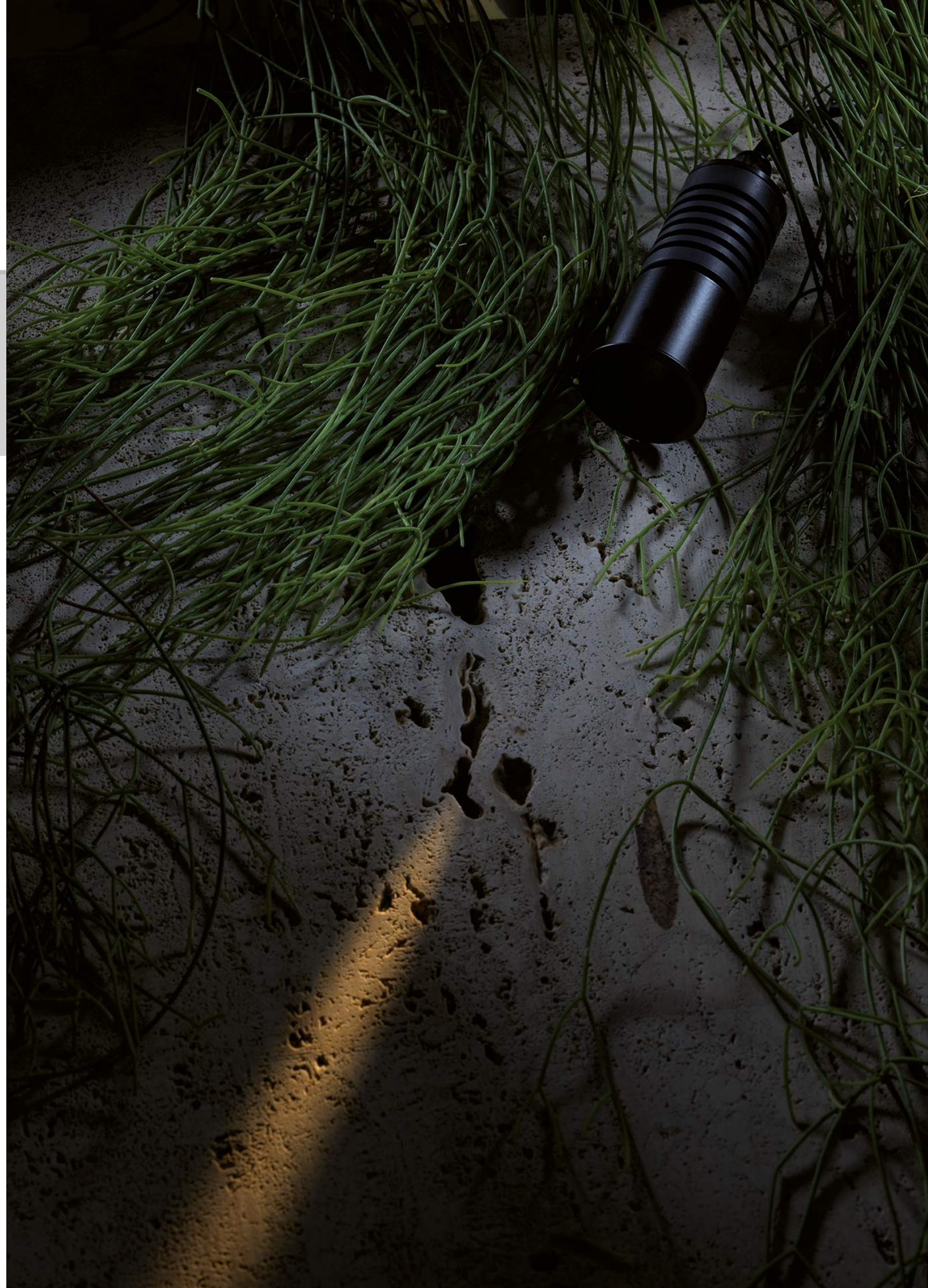

MAE 2

design: Roberto Mantovani

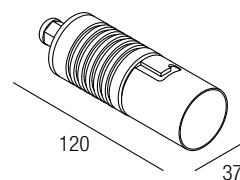

Supply current

Alimentazione
Courant d'alimentation
Stromversorgung
Corriente de alimentación

350-500 mA (V, 2,9V)

Power

Potenza
Puissance
Bestuekung
Potencia

1-2 W

Series wiring

Cablaggio in serie
Câblage en série
Verkabelung in Serie
Cableado en serie

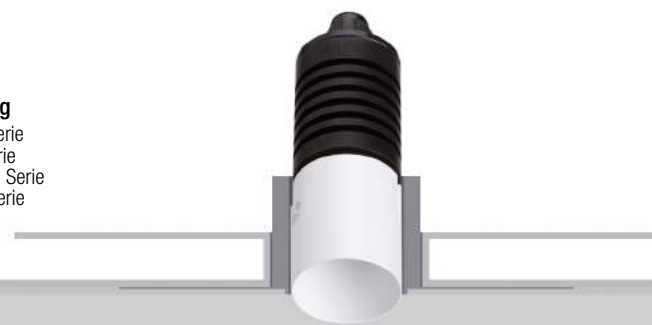

Photometric diagrams

F400

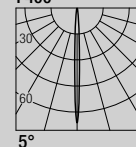

CCT/CRI/Flux

	350mA	500mA
2700K	89 lm	128 lm
3000K	93 lm	133 lm
4200K	103 lm	154 lm
6000K	114 lm	165 lm

CRI85

2-Step MacAdam

Code Construction

Costruzione del codice - Construction du code produit
Bau der Produkt-Code - Construcción del código de producto

ME1 X X 5

Beam angle 5°

Apertura di fascio
Angle de faisceau
Strahlwinkel
Ángulo del haz

Color

Temperature

0	1	2	3	6	7	8
2700K	3000K	4200K	6000K	Blue	Green	Red
				Blu	Verde	Rosso
				Bleu	Vert	Rouge
				Blau	Grün	Rot
				Azul		Rojo

Finishing

B N

	B	N
Finitura	White	Black
Finitions	Bianco	Nero
Oberflächenfinish	Blanc	Noir
Acabados	Weiß	Schwarz
	Blanco	Negro

- [DATASHEET ▶](#)
- [INSTALLATION MANUAL ▶](#)
- [CERTIFICATIONS ▶](#)
- [LDT-IES ▶](#)
- [DRAWINGS ▶](#)

Accessories

Accessori - Accessoires
Zubehör - Accesorios

ZQT00U ZQT00UB

White
Bianco
Blanc
Weiß
Blanco

Black
Nero
Noir
Schwarz
Negro

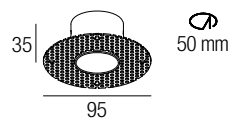

Plasterboard recessing frame
Flangia per cartongesso
Boîtier d'encastrement pour plaques de plâtre
Gehäuses Trockenbau
Cajetín para placas de yeso

Drivers

Alimentatori - Alimentateurs
Netzteile - Alimentadores

350 mA		500 mA	
on/off	dimnable	on/off	dimnable
AL1034 (1.11) 30mm IP20	AL4000 (1.12) 72mm IP20 PUSH 0/1..10V	AL1074 (1.7) 30mm IP20	AL4010 (1.12) 72mm IP20 PUSH 0/1..10V
AL1035 (1.11) 40mm IP20	AL4051 (2.14) 72mm IP20 DALI 2	AL1077 (1.6) 40mm IP20	AL4151 (2.14) 72mm IP20 DALI 2
AL1037 (1.16) 55mm IP20 S.P.	AL4053 (1.14) 56mm IP20 PUSH IGBT-TRIAC	AL1084 (1.11) 55mm IP20 S.P.	AL4153 (1.14) 56mm IP20 PUSH IGBT-TRIAC
AL9011 (1.12) 44mm IP67	AL8035 (4.16) IP67 DALI	AL9051 (1.11) 44mm IP67	AL8050 (4.16) IP67 DALI



GREG

design: Roberto Mantovani

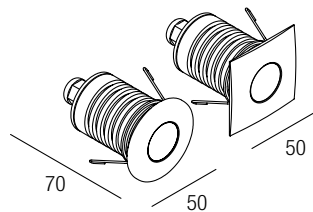

Supply current

Alimentazione
Courant d'alimentation
Stromversorgung
Corriente de alimentación
24 VDC

Power

Potenza
Puissance
Bestuekung
Potencia
2 W

Parallel wiring

Cablaggio in parallelo
Câblage en parallèle
Verkabelung in parallel
Cableado en paralelo



CCT/CRI/Flux

2700K — 128 lm
3000K — 133 lm
4200K — 154 lm

Photometric diagrams

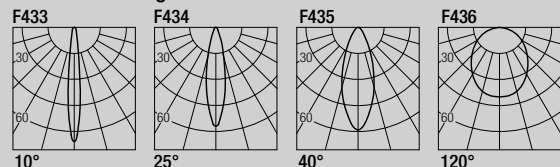

CRI85
2-Step MacAdam

Code Construction

Costruzione del codice - Construction du code produit
Bau der Produkt-Code - Construcción del código de producto

GR X X X X

Beam angle
Apertura di fascio
Angle de faisceau
Strahlwinkel
Ángulo del haz

S	M	W	X
10°	25°	40°	120°

Finishing

B	G	N	K	Z
White	Grey	Black	COR-TEN	INOX AISI 316L
Bianco	Grigio	Nero		Steel
Blanc	Gris	Noir		Acciaio
Weiß	Grau	Schwarz		Acier
Blanco		Negro		Stahl
				Acero

Color Temperature
Temperatura colore
Température couleur
Temperaturabhängige Farbe
Temperatura de color

2	3	4
2700K	3000K	4200K

Shape

1	2
Round	Square
Tondo	Quadro
Ronde	Carré
Runde	Quadrat
Redondo	Cuadrado

Accessories

Accessori - Accessoires
Zubehör - Accesorios

CSXT01

Recessing box
Controcassa
Boîtier d'encastrement
Eingieβgehäuse
Caja de empotrar

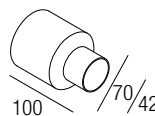

LGR01

Low luminance louver
Filtro antiabbagliamento
Filtre basse luminance
Geringe Leuchtdichte-Filter
Filtro de baja luminancia

Note: the filter must be ordered together with the lighting fixture - **Nota:** il filtro deve essere ordinato congiuntamente all'apparecchio - **Note:** le filtre doit être commandé en même temps que l'appareil - **Anmerkung:** muss der Filter zusammen mit Leuchtkörper bestellt werden
Nota: el filtro debe pedirse junto con la luminaria

Drivers

Alimentatori - Alimentateurs
Netzteile - Alimentadores

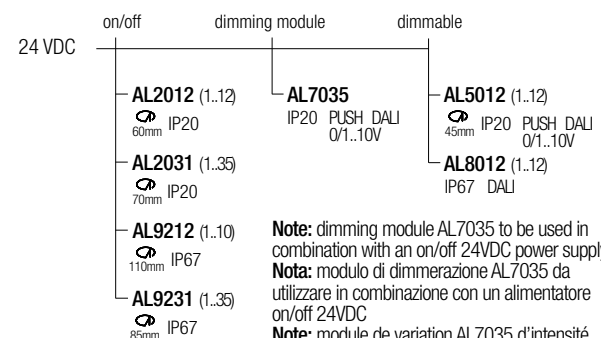

Note: dimming module AL7035 to be used in combination with an on/off 24VDC power supply
Nota: modulo di dimmerazione AL7035 da utilizzare in combinazione con un alimentatore on/off 24VDC
Note: module de variation AL7035 d'intensité à utiliser en combinaison avec une alimentation on/off 24VDC
Anmerkung: Dimmmodul AL7035 zur Verwendung in Kombination mit einem on/off 24VDC-Netzteil
Nota: módulo de regulación AL7035 se utiliza en combinación con una fuente de alimentación on/off 24VDC

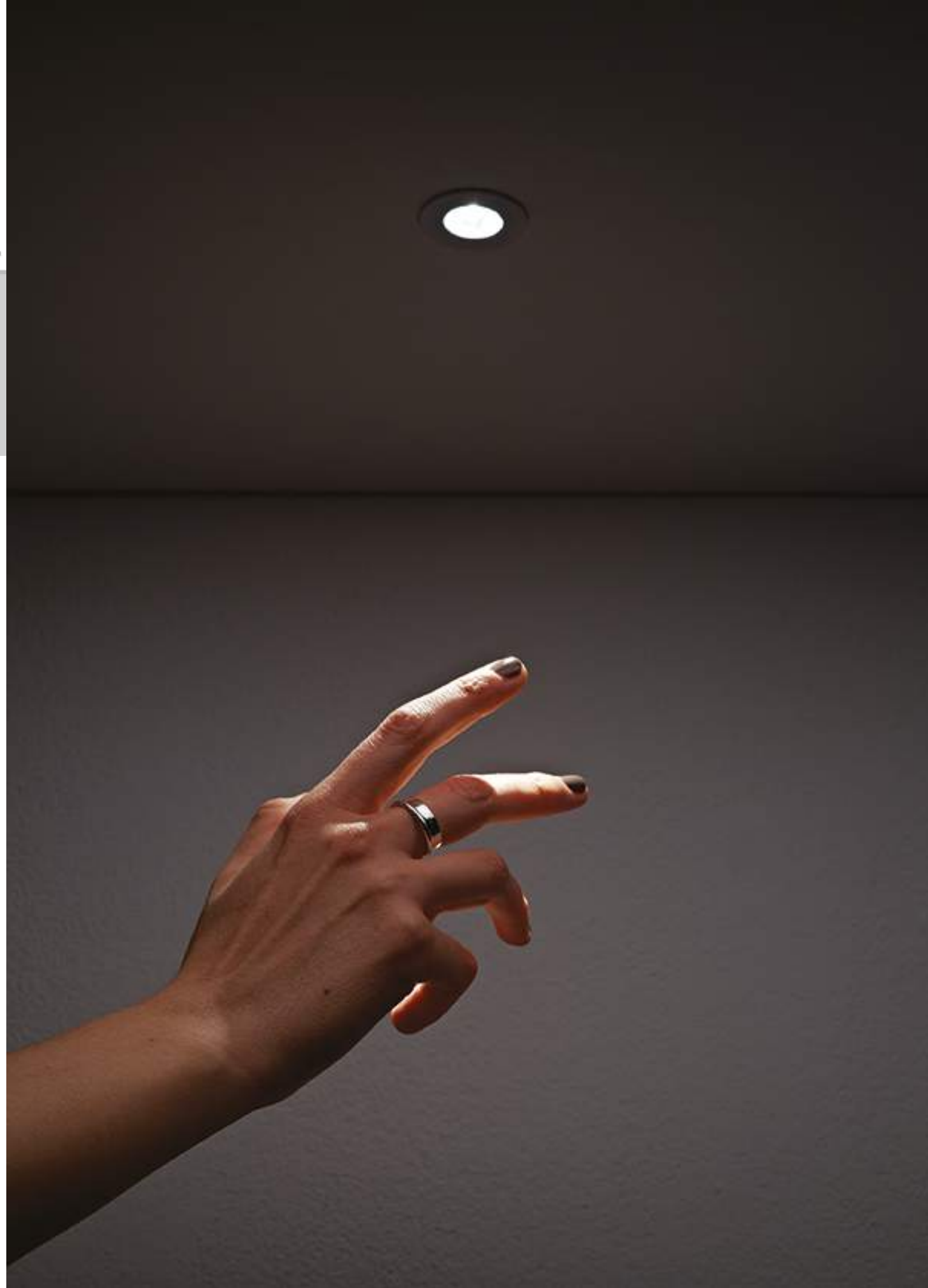

JUPITER

design: Roberto Mantovani

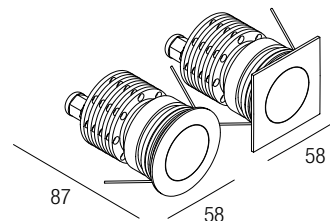

Supply current
Alimentazione
Courant d'alimentation
Stromversorgung
Corriente de alimentación
24 VDC

Power
Potenza
Puissance
Bestuekung
Potencia
7 W

Parallel wiring
Cablaggio in parallelo
Câblage en parallèle
Verkabelung in parallel
Cableado en paralelo



Photometric diagrams

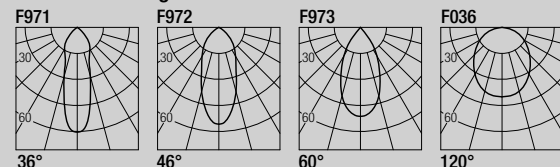

CCT/CRI/Flux	CRI85	CRI93
2700K	630 lm	590 lm
3000K	700 lm	650 lm
4000K	730 lm	670 lm

CRI85 - CRI93
2-Step MacAdam

Code Construction

Costruzione del codice - Construction du code produit
Bau der Produkt-Code - Construcción del código de producto

JP1 X X X X X

Beam angle
Apertura di fascio
Angle de faisceau
Strahlwinkel
Ángulo del haz

S	M	W	X
36°	46°	60°	120°

Finishing

	B	G	N	K	Z
Finitura Finitions Oberflächenfinish Acabados	White Bianco Blanc Weiß Blanco	Grey Grigio Gris Grau	Black Nero Noir Schwarz Negro	COR-TEN	INOX AISI 316L Steel Acciaio Acier Stahl Acero

CRI

8	9
85	93

Color Temperature
Temperatura colore
Température couleur
Temperaturabhängige Farbe
Temperatura de color

2	3	4
2700K	3000K	4000K

Shape

1	2
Round Tondo Ronde Runde Redondo	Square Quadro Carré Quadrat Cuadrado

Accessories

Accessori - Accessoires
Zubehör - Accesorios

CSDS10

Recessing box
Controcassa
Boîtier d'encastrement
Eingießgehäuse
Caja de empotrar

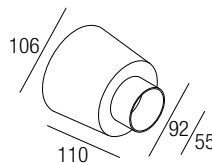

LJP101

Low luminance louver
Filtro antiabbagliamento
Filtre basse luminance
Geringe Leuchtdichte-Filter
Filtro de baja luminancia

Note: the filter must be ordered together with the lighting fixture - **Nota:** il filtro deve essere ordinato congiuntamente all'apparecchio - **Note:** le filtre doit être commandé en même temps que l'appareil - **Anmerkung:** muss der Filter zusammen mit Leuchtkörper bestellt werden
Nota: el filtro debe pedirse junto con la luminaria

Drivers

Alimentatori - Alimentateurs
Netzteile - Alimentadores

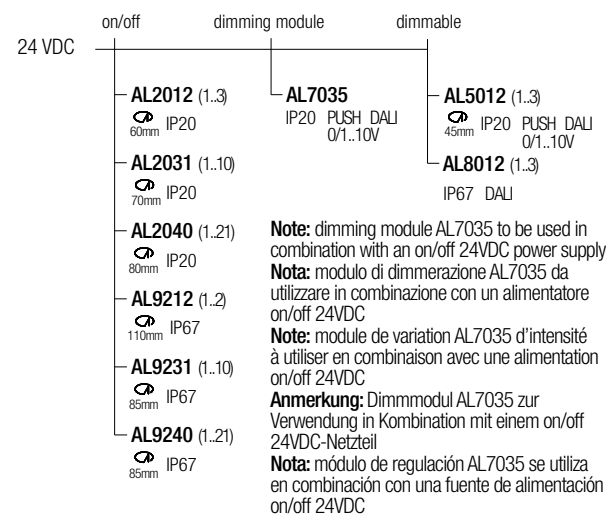

ERIS

design: Roberto Mantovani

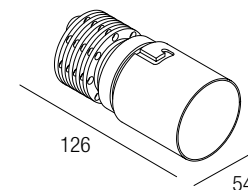

Supply current
Alimentazione
Courant d'alimentation
Stromversorgung
Corriente de alimentación
24 VDC

Power
Potenza
Puissance
Bestuekung
Potencia
7 W

Parallel wiring
Cablaggio in parallelo
Câblage en parallèle
Verkabelung in parallel
Cableado en paralelo



Photometric diagrams

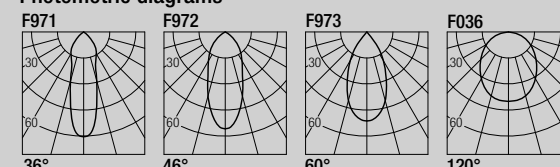

CCT/CRI/Flux	CRI85	CRI93
2700K	630 lm	590 lm
3000K	700 lm	650 lm
4000K	730 lm	670 lm

CRI85 - CRI93
2-Step MacAdam

Code Construction

Costruzione del codice - Construction du code produit
Bau der Produkt-Code - Construcción del código de producto

ER1 X X X X X

Beam angle
Apertura di fascio
Angle de faisceau
Strahlwinkel
Ángulo del haz

S	M	W	X
36°	46°	60°	120°

Finishing

	B	N
Finitura Finitions Oberflächenfinish Acabados	White Bianco Blanc Weiß Blanco	Black Nero Noir Schwarz Negro

CRI

8	9
85	93

Color Temperature
Temperatura colore
Température couleur
Temperaturabhängige Farbe
Temperatura de color

2	3	4
2700K	3000K	4000K

Accessories

Accessori - Accessoires
Zubehör - Accesorios

ZTC10U ZTC10UB

White
Bianco
Blanc
Weiß
Blanco

Black
Nero
Noir
Schwarz
Negro

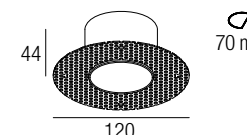

Plasterboard recessing frame
Flangia per cartongesso
Boîtier d'encastrement pour plaques de plâtre
Gehäuses Trockenbau
Cajetín para placas de yeso

LER101

Low luminance louver
Filtro antiabbagliamento
Filtre basse luminance
Geringe Leuchtdichte-Filter
Filtro de baja luminancia

Note: the filter must be ordered together with the lighting fixture - **Nota:** il filtro deve essere ordinato congiuntamente all'apparecchio - **Note:** le filtre doit être commandé en même temps que l'appareil - **Anmerkung:** muss der Filter zusammen mit Leuchtkörper bestellt werden
Nota: el filtro debe pedirse junto con la luminaria

Drivers

Alimentatori - Alimentateurs
Netzteile - Alimentadores

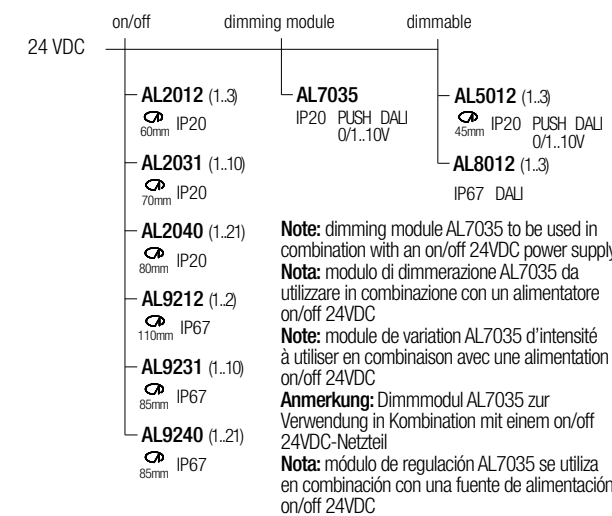

VENUS

design: Roberto Mantovani

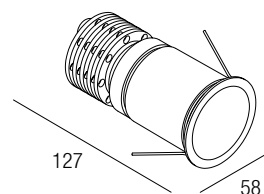

Supply current

Alimentazione
Courant d'alimentation
Stromversorgung
Corriente de alimentación

24 VDC

Power

Potenza
Puissance
Bestuekung
Potencia

7 W

Parallel wiring

Cablaggio in parallelo
Câblage en parallèle
Verkabelung in parallel
Cableado en paralelo



Photometric diagrams

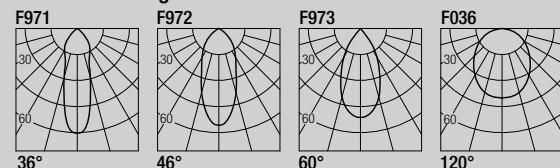

CCT/CRI/Flux

	CRI85	CRI93
2700K	630 lm	590 lm
3000K	700 lm	650 lm
4000K	730 lm	670 lm

CRI85 - CRI93

2-Step MacAdam

Code Construction

Costruzione del codice - Construction du code produit
Bau der Produkt-Code - Construcción del código de producto

VN1 X X X X

Beam angle

	S	M	W	X
Apertura di fascio Angle de faisceau Strahlwinkel Ángulo del haz	36°	46°	60°	120°

Finishing

	B	G	N	K
Finitura Finitions Oberflächenfinish Acabados	White Bianco Blanc Weiß Blanco	Grey Grigio Gris Grau	Black Nero Noir Schwarz Negro	COR-TEN

CRI

	8	9
	85	93

Color Temperature

	2	3	4
Temperatura colore Température couleur Temperaturabhängige Farbe Temperatura de color	2700K	3000K	4000K

Accessories

Accessori - Accessoires
Zubehör - Accesorios

CSBT10

Recessing box
Controcassa
Boîtier d'encastrement
Eingießgehäuse
Caja de empotrar

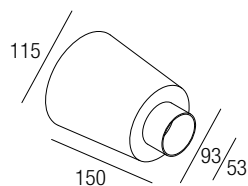

LVN101

Low luminance louver
Filtro antiabbagliamento
Filtre basse luminance
Geringe Leuchtdichte-Filter
Filtro de baja luminancia



Note: the filter must be ordered together with the lighting fixture - **Nota:** il filtro deve essere ordinato congiuntamente all'apparecchio - **Note:** le filtre doit être commandé en même temps que l'appareil - **Anmerkung:** muss der Filter zusammen mit Leuchtkörper bestellt werden
Nota: el filtro debe pedirse junto con la luminaria

Drivers

Alimentatori - Alimentateurs
Netzteile - Alimentadores

24 VDC	on/off	dimming module	dimmable
AL2012 (1..3)	60mm IP20	AL7035 IP20 PUSH DALI 0/1..10V	AL5012 (1..3) 45mm IP20 PUSH DALI 0/1..10V
AL2031 (1..10)	70mm IP20		AL8012 (1..3) IP67 DALI
AL2040 (1..21)	80mm IP20	Note: dimming module AL7035 to be used in combination with an on/off 24VDC power supply Nota: modulo di dimmerazione AL7035 da utilizzare in combinazione con un alimentatore on/off 24VDC Note: module de variation AL7035 d'intensité à utiliser en combinaison avec une alimentation on/off 24VDC Anmerkung: Dimmmodul AL7035 zur Verwendung in Kombination mit einem on/off 24VDC-Netzteil Nota: módulo de regulación AL7035 se utiliza en combinación con una fuente de alimentación on/off 24VDC	
AL9212 (1..2)	110mm IP67		
AL9231 (1..10)	85mm IP67		
AL9240 (1..21)	85mm IP67		



WOTAN 5

design: Lapo Grassellini

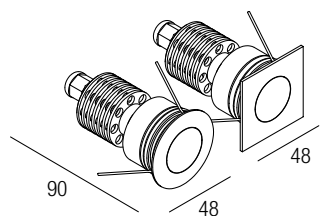

Supply current

Alimentazione
Courant d'alimentation
Stromversorgung
Corriente de alimentación

140 mA (V, 36V)

Power

Potenza
Pouissance
Bestuekung
Potencia

5 W



Photometric diagrams

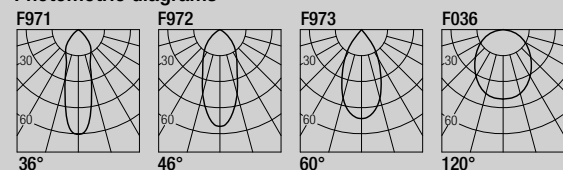

CCT/CRI/Flux

	CRI85	CRI93
2700K	450 lm	425 lm
3000K	510 lm	470 lm
4000K	530 lm	490 lm

CRI85 - CRI93
2-Step MacAdam

Code Construction

Costruzione del codice - Construction du code produit
Bau der Produkt-Code - Construcción del código de producto

WT5 X X X X X

Beam angle

	S	M	W	X
Apertura di fascio Angle de faisceau Strahlwinkel Ángulo del haz	36°	46°	60°	120°

Finishing

	B	G	N	K	Z
Finitura Finitions Oberflächenfinish Acabados	White Bianco Blanc Weiß Blanco	Grey Grigio Gris Grau	Black Nero Noir Schwarz Negro	COR-TEN	INOX AISI 316L Steel Acciaio Acier Stahl Acero

CRI	8	9
	85	93

Color Temperature

	2	3	4
Temperatura colore Température couleur Temperaturabhängige Farbe Temperatura de color	2700K	3000K	4000K

Shape

	1	2
Forma Forme Form	Round Tondo Ronde Runde Redondo	Square Quadro Carré Quadrat Cuadrado

Accessories

Accessori - Accessoires
Zubehör - Accesorios

CSDS05

Recessing box
Controcassa
Boîtier d'encastrement
Eingießegehäuse
Caja de empotrar

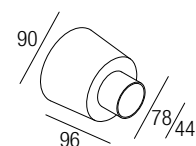

LWT501

Low luminance louver
Filtro antiabbagliamento
Filtre basse luminance
Geringe Leuchtdichte-Filter
Filtro de baja luminancia

Note: the filter must be ordered together with the lighting fixture - **Nota:** il filtro deve essere ordinato congiuntamente all'apparecchio - **Note:** le filtre doit être commandé en même temps que l'appareil - **Anmerkung:** muss der Filter zusammen mit Leuchtkörper bestellt werden
Nota: el filtro debe pedirse junto con la luminaria

Drivers

Alimentatori - Alimentateurs
Netzteile - Alimentadores

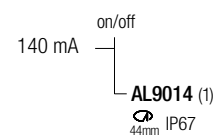

WOTAN 10

design: Lapo Grassellini

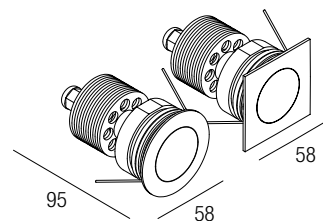

Supply current
 Alimentazione
 Courant d'alimentation
 Stromversorgung
 Corriente de alimentación
250 mA (V, 36V)

Power
 Potenza
 Pouissance
 Bestuekung
 Potencia
10 W



Photometric diagrams

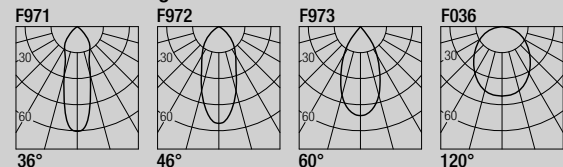

CCT/CRI/Flux	CRI85	CRI93
2700K	890 lm	840 lm
3000K	1000 lm	930 lm
4000K	1040 lm	960 lm

CRI85 - CRI93
2-Step MacAdam

Code Construction

Costruzione del codice - Construction du code produit
 Bau der Produkt-Code - Construcción del código de producto

WT1 X X X X X

Beam angle	S	M	W	X
Apertura di fascio Angle de faisceau Strahlwinkel Ángulo del haz	36°	46°	60°	120°

Finishing	B	G	N	K	Z
Finitura Finitions Oberflächenfinish Acabados	White Bianco Blanc Weiß Blanco	Grey Grigio Gris Grau	Black Nero Noir Schwarz Negro	COR-TEN	INOX AISI 316L Steel Acciaio Acier Stahl Acero

CRI	8	9
	85	93

Color Temperature	2	3	4
Temperatura colore Température couleur Temperaturabhängige Farbe Temperatura de color	2700K	3000K	4000K

Shape	1	2
Forma Forme Form	Round Tondo Ronde Runde Redondo	Square Quadro Carré Quadrat Cuadrado

Accessories

Accessori - Accessoires
 Zubehör - Accesorios

CSDS10

Recessing box
 Controcassa
 Boîtier d'encastrement
 Eingießgehäuse
 Caja de empotrar

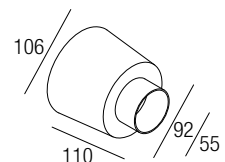

LWT101

Low luminance louver
 Filtro antiabbagliamento
 Filtre basse luminance
 Geringe Leuchtdichte-Filter
 Filtro de baja luminancia



Note: the filter must be ordered together with the lighting fixture - **Nota:** il filtro deve essere ordinato congiuntamente all'apparecchio - **Note:** le filtre doit être commandé en même temps que l'appareil - **Anmerkung:** muss der Filter zusammen mit Leuchtkörper bestellt werden
Nota: el filtro debe pedirse junto con la luminaria

Drivers

Alimentatori - Alimentateurs
 Netzteile - Alimentadores

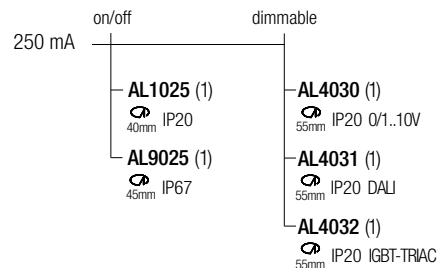

WOTAN 20

design: Lapo Grassellini

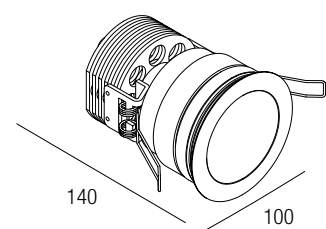

Supply current

Alimentazione
Courant d'alimentation
Stromversorgung
Corriente de alimentación
500 mA (V, 36V)

Power

Potenza
Puissance
Bestuekung
Potencia
20 W



Photometric diagrams

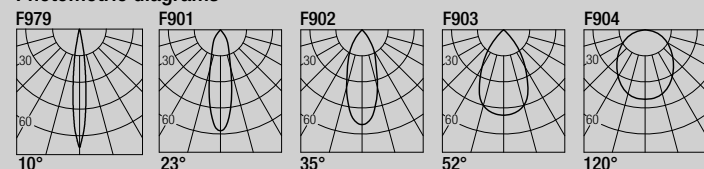

CCT/CRI/Flux

	CRI85	CRI93
2700K	1830 lm	1700 lm
3000K	2000 lm	1830 lm
4000K	2100 lm	1950 lm

CRI85 - CRI93

2-Step MacAdam

Code Construction

Costruzione del codice - Construction du code produit
Bau der Produkt-Code - Construcción del código de producto

WT2 X X X X

Beam angle	XS	S	M	W	X
Apertura di fascio Angle de faisceau Strahlwinkel Ángulo del haz	10°	23°	35°	52°	120°
Finishing	B	G	N	K	Z
Finitura Finitions Oberflächenfinish Acabados	White Bianco Blanc Weiß Blanco	Grey Grigio Gris Grau	Black Nero Noir Schwarz Negro	COR-TEN	INOX AISI 316L Steel Acciaio Acier Stahl Aceró
CRI	8	9			
	85	93			
Color Temperature	2	3	4		
Temperatura colore Température couleur Temperaturabhängige Farbe Temperatura de color	2700K	3000K	4000K		

Accessories

Accessori - Accessoires
Zubehör - Accesorios

CSDS20

Recessing box
Controcassa
Boîtier d'encastrement
EingieBgehäuse
Caja de empotrar

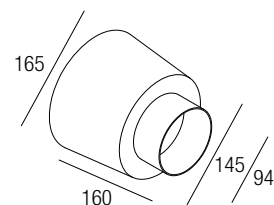

LWT201

Low luminance louver
Filtro antiabbagliamento
Filtre basse luminance
Geringe Leuchtdichte-Filter
Filtro de baja luminancia



Note: the filter must be ordered together with the lighting fixture - **Nota:** il filtro deve essere ordinato congiuntamente all'apparecchio - **Note:** le filtre doit être commandé en même temps que l'appareil - **Anmerkung:** muss der Filter zusammen mit Leuchtkörper bestellt werden
Nota: el filtro debe pedirse junto con la luminaria

Drivers

Alimentatori - Alimentateurs
Netzteile - Alimentadores

on/off	dimmable
500 mA	
AL1084 (1) 55mm IP20 S.P.	AL4010 (1) 72mm IP20 PUSH 0/1..10V
AL9052 (1) 44mm IP67	AL4151 (1) 72mm IP20 DALI 2
	AL4153 (1) 60mm IP20 PUSH IGBT-TRIAC
	AL8050 (1) IP67 DALI

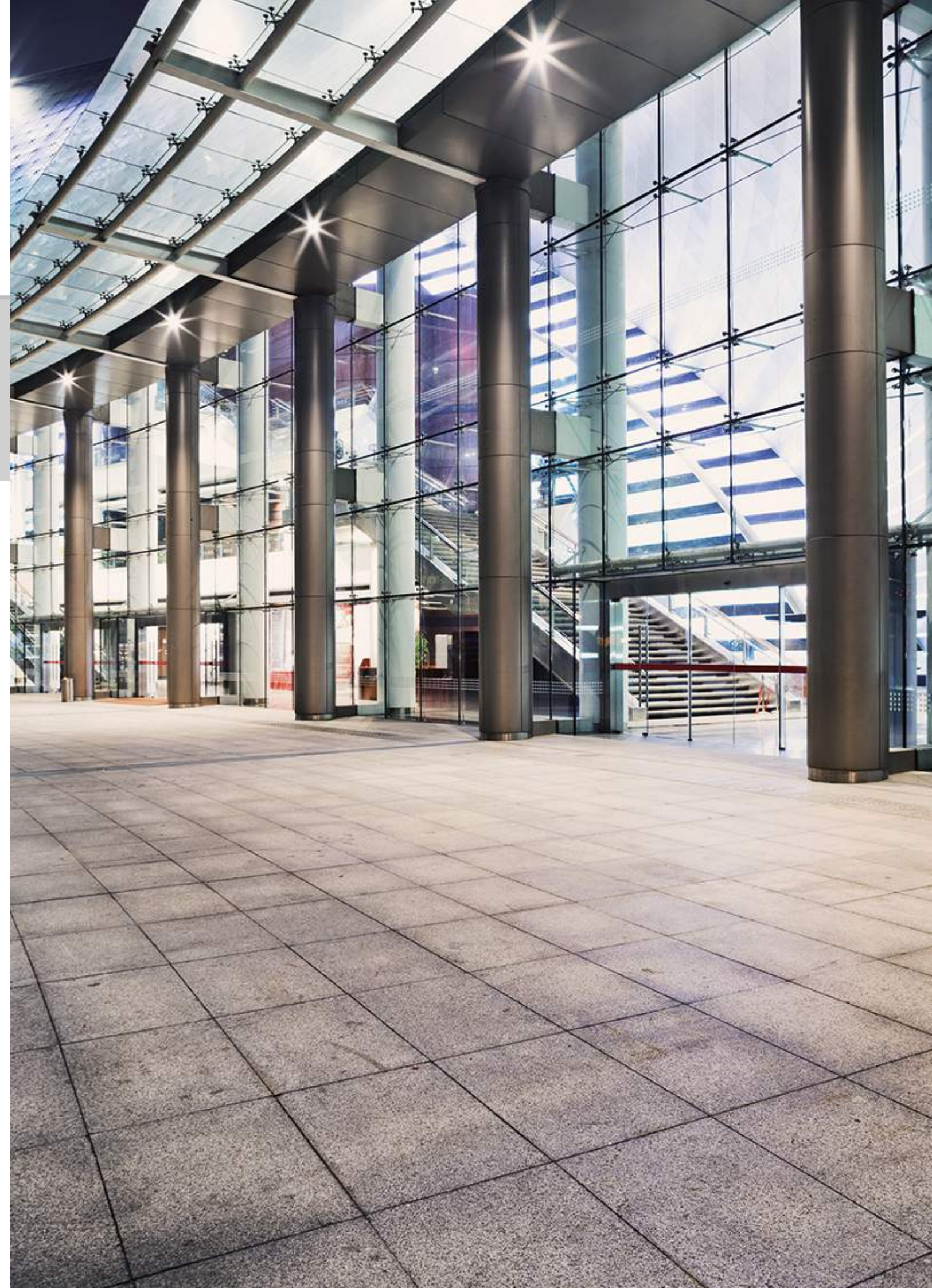

BATAN 5

design: Roberto Mantovani

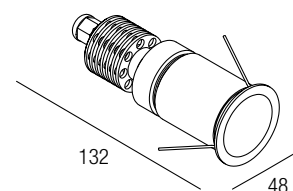

Supply current

Alimentazione
Courant d'alimentation
Stromversorgung
Corriente de alimentación

140 mA (V, 36V)

Power

Potenza
Puissance
Bestuekung
Potencia

5 W



Photometric diagrams

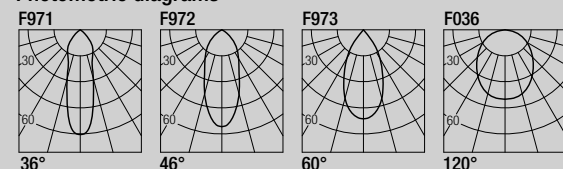

CCT/CRI/Flux

	CRI85	CRI93
2700K	450 lm	425 lm
3000K	510 lm	470 lm
4000K	530 lm	490 lm

CRI85 - CRI93
2-Step MacAdam

Code Construction

Costruzione del codice - Construction du code produit
Bau der Produkt-Code - Construcción del código de producto

BN5 X X X X

Beam angle	S	M	W	X
Apertura di fascio Angle de faisceau Strahlwinkel Ángulo del haz	36°	46°	60°	120°

Finishing	B	G	N	K
Finitura Finitions Oberflächenfinish Acabados	White Bianco Blanc Weiß Blanco	Grey Grigio Gris Grau	Black Nero Noir Schwarz Negro	COR-TEN

CRI	8	9
	85	93

Color Temperature	2	3	4
Temperatura colore Température couleur Temperaturabhängige Farbe Temperatura de color	2700K	3000K	4000K

Accessories

Accessori - Accessoires
Zubehör - Accesorios

CSBT05

Recessing box
Controcassa
Boîtier d'encastrement
Eingießegehäuse
Caja de empotrar

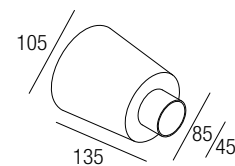

LBN501

Low luminance louver
Filtro antiabbagliamento
Filtre basse luminance
Geringe Leuchtdichte-Filter
Filtro de baja luminancia



Note: the filter must be ordered together with the lighting fixture - **Nota:** il filtro deve essere ordinato congiuntamente all'apparecchio - **Note:** le filtre doit être commandé en même temps que l'appareil - **Anmerkung:** muss der Filter zusammen mit Leuchtkörper bestellt werden
Nota: el filtro debe pedirse junto con la luminaria

Drivers

Alimentatori - Alimentateurs
Netzteile - Alimentadores



BATAN 10

design: Roberto Mantovani

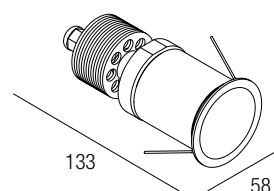

Supply current

Alimentazione
 Courant d'alimentation
 Stromversorgung
 Corriente de alimentación
250 mA (V, 36V)

Power

Potenza
 Pouissance
 Bestuekung
 Potencia
10 W



CCT/CRI/Flux

	CRI85	CRI93
2700K	890 lm	840 lm
3000K	1000 lm	930 lm
4000K	1040 lm	960 lm

CRI85 - CRI93

2-Step MacAdam

Photometric diagrams

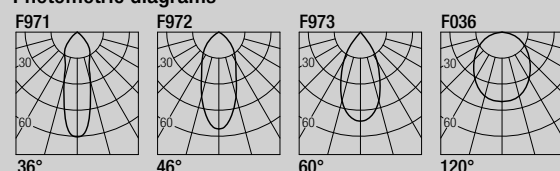

Code Construction

Costruzione del codice - Construction du code produit
 Bau der Produkt-Code - Construcción del código de producto

BN1.X.X.X.X

Beam angle	S	M	W	X
Apertura di fascio Angle de faisceau Strahlwinkel Ángulo del haz	36°	46°	60°	120°
Finishing	B	G	N	K
Finitura Finitions Oberflächenfinish Acabados	White Bianco Weiß Blanco	Grey Grigio Gris Grau	Black Nero Noir Schwarz Negro	COR-TEN
CRI	8	9		
	85	93		
Color Temperature	2	3	4	
Temperatura colore Température couleur Temperaturabhängige Farbe Temperatura de color	2700K	3000K	4000K	

Accessories

Accessori - Accessoires
 Zubehör - Accesorios

CSBT10

Recessing box
 Controcassa
 Boîtier d'encastrement
 Eingießgehäuse
 Caja de empotrar

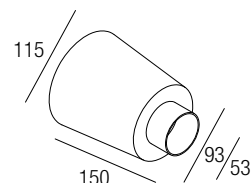

LBN101

Low luminance louver
 Filtro antiabbagliamento
 Filtre basse luminance
 Geringe Leuchtdichte-Filter
 Filtro de baja luminancia



Note: the filter must be ordered together with the lighting fixture - **Nota:** il filtro deve essere ordinato congiuntamente all'apparecchio - **Note:** le filtre doit être commandé en même temps que l'appareil - **Anmerkung:** muss der Filter zusammen mit Leuchtkörper bestellt werden
Nota: el filtro debe pedirse junto con la luminaria

Drivers

Alimentatori - Alimentateurs
 Netzteile - Alimentadores

250 mA	on/off	dimnable
	AL1025 (1) 40mm IP20	AL4030 (1) 55mm IP20 0/1..10V
	AL9025 (1) 44mm IP67	AL4031 (1) 55mm IP20 DALI
		AL4032 (1) 55mm IP20 IGBT-TRIAC



ZETAN 5

design: Roberto Mantovani

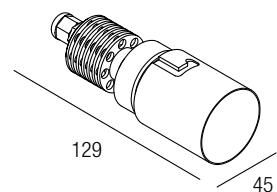

Supply current

Alimentazione
Courant d'alimentation
Stromversorgung
Corriente de alimentación
140 mA (V_i 36V)

Power

Potenza
Puissance
Bestuekung
Potencia
5 W



Photometric diagrams

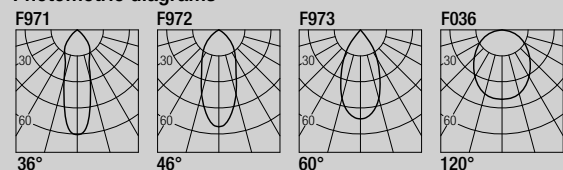

CCT/CRI/Flux

	CRI85	CRI93
2700K	450 lm	425 lm
3000K	510 lm	470 lm
4000K	530 lm	490 lm

CRI85 - CRI93
2-Step MacAdam

Code Construction

Costruzione del codice - Construction du code produit
Bau der Produkt-Code - Construcción del código de producto

ZN5 X X X X

Beam angle **S M W X**
Apertura di fascio 36° 46° 60° 120°
Angle de faisceau
Strahlwinkel
Ángulo del haz

Finishing **B N**

White Black
Bianco Nero
Blanc Noir
Weiß Schwarz
Blanco Negro

CRI **8 9**
85 93

Color Temperature **2 3 4**
2700K 3000K 4000K
Temperatura colore
Température couleur
Temperaturabhängige Farbe
Temperatura de color



ZETAN 10

design: Roberto Mantovani

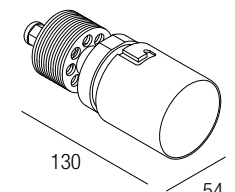

Supply current

Alimentazione
Courant d'alimentation
Stromversorgung
Corriente de alimentación
250 mA (V_i 36V)

Power

Potenza
Puissance
Bestuekung
Potencia
10 W



Photometric diagrams

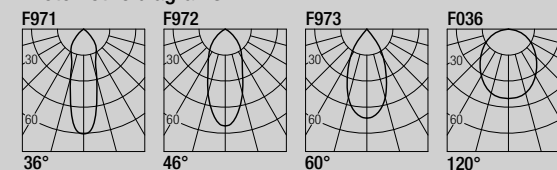

CCT/CRI/Flux

	CRI85	CRI93
2700K	890 lm	840 lm
3000K	1000 lm	930 lm
4000K	1040 lm	960 lm

CRI85 - CRI93
2-Step MacAdam

Code Construction

Costruzione del codice - Construction du code produit
Bau der Produkt-Code - Construcción del código de producto

ZN1 X X X X

Beam angle **S M W X**
Apertura di fascio 36° 46° 60° 120°
Angle de faisceau
Strahlwinkel
Ángulo del haz

Finishing **B N**

White Black
Bianco Nero
Blanc Noir
Weiß Schwarz
Blanco Negro

CRI **8 9**
85 93

Color Temperature **2 3 4**
2700K 3000K 4000K
Temperatura colore
Température couleur
Temperaturabhängige Farbe
Temperatura de color

Accessories

Accessori - Accessoires
Zubehör - Accesorios

ZTC05U ZTC05UB

White Black
Bianco Nero
Blanc Noir
Weiß Schwarz
Blanco Negro

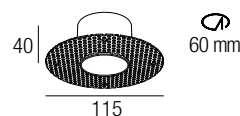

Plasterboard recessing frame
Flangia per cartongesso
Boîtier d'encastrement pour plaques de plâtre
Gehäuses Trockenbau
Cajetín para placas de yeso

LZN501

Low luminance louver
Filtro antiabbagliamento
Filtre basse luminance
Geringe Leuchtdichte-Filter
Filtro de baja luminancia

Note: the filter must be ordered together with the lighting fixture - **Nota:** il filtro deve essere ordinato congiuntamente all'apparecchio - **Note:** le filtre doit être commandé en même temps que l'appareil - **Anmerkung:** muss der Filter zusammen mit Leuchtkörper bestellt werden
Nota: el filtro debe pedirse junto con la luminaria

Drivers

Alimentatori - Alimentateurs
Netzteile - Alimentadores



Accessories

Accessori - Accessoires
Zubehör - Accesorios

ZTC10U ZTC10UB

White Black
Bianco Nero
Blanc Noir
Weiß Schwarz
Blanco Negro

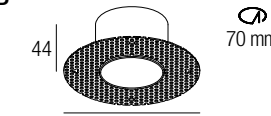

Plasterboard recessing frame
Flangia per cartongesso
Boîtier d'encastrement pour plaques de plâtre
Gehäuses Trockenbau
Cajetín para placas de yeso

LZN101

Low luminance louver
Filtro antiabbagliamento
Filtre basse luminance
Geringe Leuchtdichte-Filter
Filtro de baja luminancia

Note: the filter must be ordered together with the lighting fixture - **Nota:** il filtro deve essere ordinato congiuntamente all'apparecchio - **Note:** le filtre doit être commandé en même temps que l'appareil - **Anmerkung:** muss der Filter zusammen mit Leuchtkörper bestellt werden
Nota: el filtro debe pedirse junto con la luminaria

Drivers

Alimentatori - Alimentateurs
Netzteile - Alimentadores

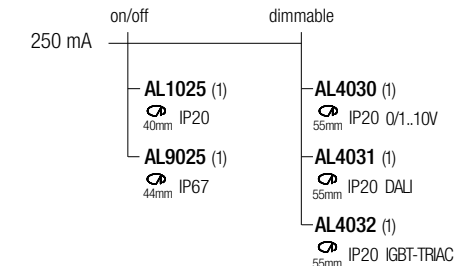

SLOT 2

design: Roberto Mantovani

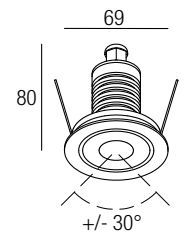

Supply current

Alimentazione
Courant d'alimentation
Stromversorgung
Corriente de alimentación
350-500 mA (V, 2,9V)

Power

Potenza
Puissance
Bestuekung
Potencia
1-2 W

Series wiring

Cablaggio in serie
Câblage en série
Verkabelung in Serie
Cableado en serie



CCT/CRI/Flux

	350mA	500mA
2700K	89 lm	128 lm
3000K	93 lm	133 lm
4200K	103 lm	154 lm
6000K	114 lm	165 lm

CRI85

2-Step MacAdam

Photometric diagrams

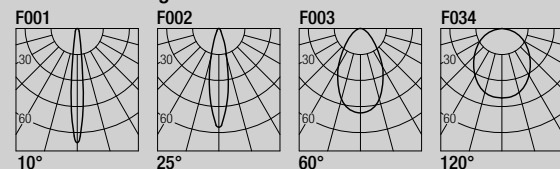

Code Construction

Costruzione del codice - Construction du code produit
Bau der Produkt-Code - Construcción del código de producto

SL2 X X X

Finishing

	B	G	N	K	Z
Finitura Finitions Oberflächenfinish Acabados	White Bianco Blanc Weiß Blanco	Grey Grigio Gris Grau	Black Nero Noir Schwarz Negro	COR-TEN	INOX AISI 316L Steel Acciaio Acier Stahl Acero

Color Temperature

	0	1	2	3	6	7	8
Temperatura colore Température couleur Temperaturabhängige Farbe Temperatura de color	2700K	3000K	4200K	6000K	Blue Blu Bleu Blau Azul	Green Verde Vert Grün	Red Rosso Rouge Rot Rojo

Beam angle

	0	1	2	9
Apertura di fascio Angle de faisceau Strahlwinkel Ángulo del haz	10°	25°	60°	120°

Accessories

Accessori - Accessoires
Zubehör - Accesorios

CSXJ01

Recessing box
Controcassa
Boîtier d'encastrement
Eingießgehäuse
Caja de empotrar

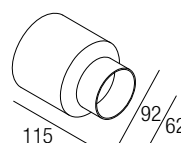

LSL201

Low luminance louver
Filtro antiabbagliamento
Filtre basse luminance
Geringe Leuchtdichte-Filter
Filtro de baja luminancia

Note: the filter must be ordered together with the lighting fixture - **Nota:** il filtro deve essere ordinato congiuntamente all'apparecchio - **Note:** le filtre doit être commandé en même temps que l'appareil - **Anmerkung:** muss der Filter zusammen mit Leuchtkörper bestellt werden
Nota: el filtro debe pedirse junto con la luminaria

Drivers

Alimentatori - Alimentateurs
Netzteile - Alimentadores

350 mA		500 mA	
on/off	dimmable	on/off	dimmable
AL1034 (1..11) 30mm	AL4000 (1..12) 72mm IP20 PUSH 0/1..10V	AL1074 (1..7) 30mm IP20	AL4010 (1..12) 72mm IP20 PUSH 0/1..10V
AL1035 (1..11) 40mm IP20	AL4051 (2..14) 72mm IP20 DALI 2	AL1077 (1..6) 40mm IP20	AL4151 (2..14) 72mm IP20 DALI 2
AL1037 (1..16) 55mm IP20	AL4053 (1..14) 56mm IP20 PUSH IGBT-TRIAC	AL1084 (1..11) 55mm IP20 S.P.	AL4153 (1..14) 56mm IP20 PUSH IGBT-TRIAC
AL9011 (1..12) 44mm IP67	AL8035 (4..16) IP67 DALI	AL9051 (1..11) 44mm IP67	AL8050 (4..16) IP67 DALI



SLOT 6

design: Roberto Mantovani

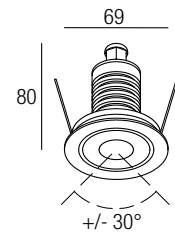

Supply current

Alimentazione
Courant d'alimentation
Stromversorgung
Corriente de alimentación

350-500 mA (V, 8,7V)

Power

Potenza
Puissance
Bestuekung
Potencia

3-6 W

Series wiring

Cablaggio in serie
Câblage en série
Verkabelung in Serie
Cableado en serie



CCT/CRI/Flux

	350mA	500mA
2700K	267 lm	384 lm
3000K	279 lm	400 lm
4200K	309 lm	462 lm
6000K	342 lm	495 lm

CRI85

2-Step MacAdam

Photometric diagrams

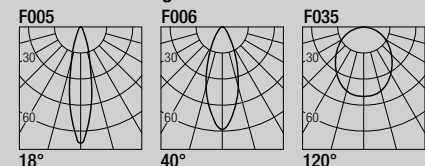

Code Construction

Costruzione del codice - Construction du code produit
Bau der Produkt-Code - Construcción del código de producto

SL6 X X X

Finishing Finitura Finitions Oberflächenfinish Acabados	B	G	N	K	Z		
	White Bianco Blanc Weiß Blanco	Grey Grigio Gris Grau	Black Nero Noir Schwarz Negro	COR-TEN Steel Acciaio Acier Stahl Acero	INOX AISI 316L		
Color Temperature Temperatura colore Température couleur Temperaturabhängige Farbe Temperatura de color	0	1	2	3	6	7	8
	2700K	3000K	4200K	6000K	Blue Blu Bleu Blau Azul	Green Verde Vert Grün	Red Rosso Rouge Rot Rojo
Beam angle Apertura di fascio Angle de faisceau Strahlwinkel Ángulo del haz	1	2	9				
	18°	40°	120°				

Accessories

Accessori - Accessoires
Zubehör - Accesorios

CSXJ01

Recessing box
Controcassa
Boîtier d'encastrement
Eingießgehäuse
Caja de empotrar

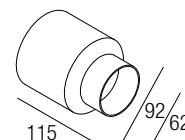

LSL601

Low luminance louver
Filtro antiabbagliamento
Filtre basse luminance
Geringe Leuchtdichte-Filter
Filtro de baja luminancia



Note: the filter must be ordered together with the lighting fixture - **Nota:** il filtro deve essere ordinato congiuntamente all'apparecchio - **Note:** le filtre doit être commandé en même temps que l'appareil - **Anmerkung:** muss der Filter zusammen mit Leuchtkörper bestellt werden
Nota: el filtro debe pedirse junto con la luminaria

Drivers

Alimentatori - Alimentateurs
Netzteile - Alimentadores

350 mA		500 mA	
on/off	dimmable	on/off	dimmable
AL1034 (1..3) 30mm IP20	AL4000 (1..4) 72mm IP20 PUSH 0/1..10V	AL1074 (1..2) 30mm IP20	AL4010 (1..4) 72mm IP20 PUSH 0/1..10V
AL1035 (1..3) 40mm IP20	AL4051 (1..4) 72mm IP20 DALI 2	AL1077 (1..2) 40mm IP20	AL4151 (1..4) 72mm IP20 DALI 2
AL1037 (1..5) 55mm IP20 S.P.	AL4053 (1..4) 56mm IP20 PUSH IGBT-TRIAC	AL1084 (1..3) 55mm IP20 S.P.	AL4153 (1..4) 56mm IP20 PUSH IGBT-TRIAC
AL9011 (1..4) 44mm IP67	AL8035 (2..4) IP67 DALI	AL9051 (1..3) 44mm IP67	AL8050 (2..4) IP67 DALI

SLOT 6 EVO

design: Roberto Mantovani

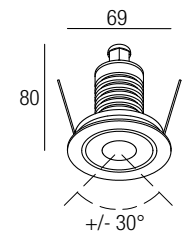

Supply current

Alimentazione
Courant d'alimentation
Stromversorgung
Corriente de alimentación
500 mA (V, 9V)

Power

Potenza
Puissance
Bestuekung
Potencia
6 W

Series wiring

Cablaggio in serie
Câblage en série
Verkabelung in Serie
Cableado en serie



CCT/CRI/Flux

2700K — **540 lm**
3000K — **600 lm**
4000K — **620 lm**

CRI98

2-Step MacAdam

Photometric diagrams

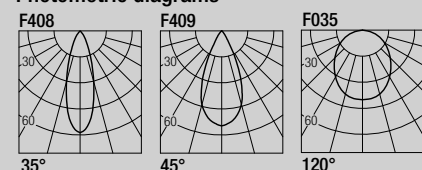

Code Construction

Costruzione del codice - Construction du code produit
Bau der Produkt-Code - Construcción del código de producto

SL6E X X X

Finishing	B	G	N	K	Z
Finitura Finitions Oberflächenfinish Acabados	White Bianco Blanc Weiß Blanco	Grey Grigio Gris Grau	Black Nero Noir Schwarz Negro	COR-TEN	INOX AISI 316L Steel Acciaio Acier Stahl Acero
Color Temperature	0	1	2		
Temperatura colore Température couleur Temperaturabhängige Farbe Temperatura de color	2700K	3000K	4000K		
Beam angle	1	2	9		
Apertura di fascio Angle de faisceau Strahlwinkel Ángulo del haz	35°	45°	120°		

Accessories

Accessori - Accessoires
Zubehör - Accesorios

CSXJ01

Recessing box
Controcassa
Boîtier d'encastrement
Eingießgehäuse
Caja de empotrar

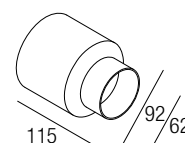

LSL6E01

Low luminance louver
Filtro antiabbagliamento
Filtre basse luminance
Geringe Leuchtdichte-Filter
Filtro de baja luminancia



Note: the filter must be ordered together with the lighting fixture - **Nota:** il filtro deve essere ordinato congiuntamente all'apparecchio - **Note:** le filtre doit être commandé en même temps que l'appareil - **Anmerkung:** muss der Filter zusammen mit Leuchtkörper bestellt werden
Nota: el filtro debe pedirse junto con la luminaria

Drivers

Alimentatori - Alimentateurs
Netzteile - Alimentadores

on/off	dimmable
AL1074 (1..2) 30mm IP20	AL4010 (1..4) 72mm IP20 PUSH 0/1..10V
AL1077 (1..2) 40mm IP20	AL4151 (1..4) 72mm IP20 DALI 2
AL1084 (1..3) 55mm IP20 S.P.	AL4153 (1..4) 59mm IP20 PUSH IGBT-TRIAC
AL9051 (1..3) 44mm IP67	AL8050 (2..4) IP67 DALI



SLOT 724

design: Roberto Mantovani

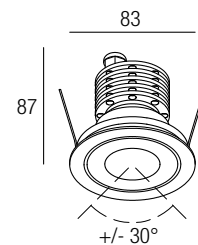

Supply current

Alimentazione
Alimentazione
Courant d'alimentation
Stromversorgung
Corriente de alimentación

24 VDC

Power

Potenza
Potenza
Puissance
Bestuekung
Potencia

7 W

Parallel wiring

Cablaggio in parallelo
Cablage en parallèle
Verkabelung in parallel
Cableado en paralelo



CCT/CRI/Flux

	CRI85	CRI93
2700K	630 lm	590 lm
3000K	700 lm	650 lm
4000K	730 lm	670 lm

Photometric diagrams

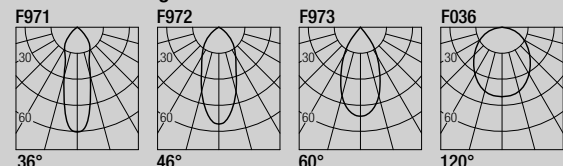

CRI85 - CRI93

2-Step MacAdam

Code Construction

Costruzione del codice - Construction du code produit
Bau der Produkt-Code - Construcción del código de producto

SL24 X X X X

Beam angle	S	M	W	X
Apertura di fascio Angle de faisceau Strahlwinkel Ángulo del haz	36°	46°	60°	120°

Finishing	B	G	N	K	Z
Finitura Finitions Oberflächenfinish Acabados	White Bianco Blanc Weiß Blanco	Grey Grigio Gris Grau	Black Nero Noir Schwarz Negro	COR-TEN	INOX AISI 316L Steel Acciaio Acier Stahl Acero

CRI	8	9
	85	93

Color Temperature	2	3	4
Temperatura colore Température couleur Temperaturabhängige Farbe Temperatura de color	2700K	3000K	4000K

Accessories

Accessori - Accessoires
Zubehör - Accesorios

CSSL01

Recessing box
Controcassa
Boîtier d'encastrement
Eingießgehäuse
Caja de empotrar

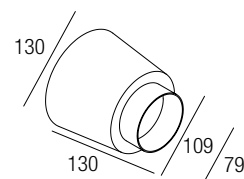

LSL2401

Low luminance louver
Filtro antiabbagliamento
Filtre basse luminance
Geringe Leuchtdichte-Filter
Filtro de baja luminancia

Note: the filter must be ordered together with the lighting fixture - **Nota:** il filtro deve essere ordinato congiuntamente all'apparecchio - **Note:** le filtre doit être commandé en même temps que l'appareil - **Anmerkung:** muss der Filter zusammen mit Leuchtkörper bestellt werden
Nota: el filtro debe pedirse junto con la luminaria

Drivers

Alimentatori - Alimentateurs
Netzteile - Alimentadores

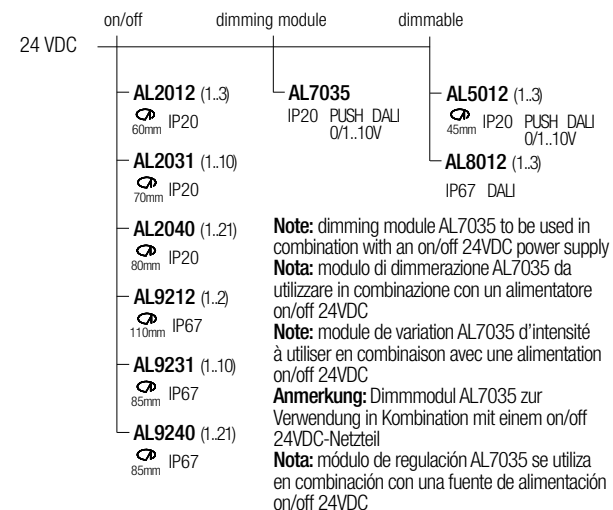

SLOT 10

design: Roberto Mantovani

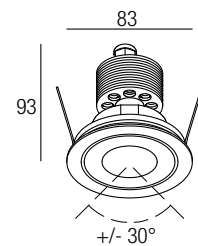

Supply current

Alimentazione
Courant d'alimentation
Stromversorgung
Corriente de alimentación

250 mA (V_i 36V)

Power

Potenza
Puissance
Bestuekung
Potencia

10 W



CCT/CRI/Flux

	CRI85	CRI93
2700K	890 lm	840 lm
3000K	1000 lm	930 lm
4000K	1040 lm	960 lm

Photometric diagrams

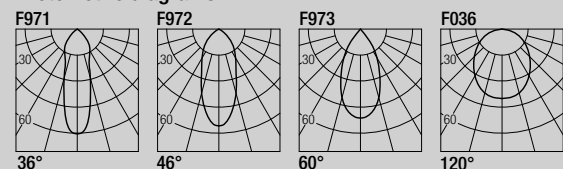

CRI85 - CRI93
2-Step MacAdam

Code Construction

Costruzione del codice - Construction du code produit
Bau der Produkt-Code - Construcción del código de producto

SL1 X X X X

Beam angle

	S	M	W	X
Apertura di fascio Angle de faisceau Strahlwinkel Ángulo del haz	36°	46°	60°	120°

Finishing

	B	G	N	K	Z
Finitura Finitions Oberflächenfinish Acabados	White Bianco Blanc Weiß Blanco	Grey Grigio Gris Grau	Black Nero Noir Schwarz Negro	COR-TEN	INOX AISI 316L Steel Acciaio Acier Stahl Acero

CRI	8	9
	85	93

Color Temperature	2	3	4
Temperatura colore Température couleur Temperaturabhängige Farbe Temperatura de color	2700K	3000K	4000K

Accessories

Accessori - Accessoires
Zubehör - Accesorios

CSSL01

Recessing box
Controcassa
Boîtier d'encastrement
Eingieβgehäuse
Caja de empotrar

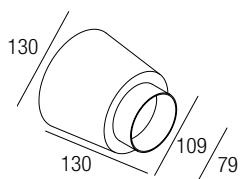

LSL101

Low luminance louver
Filtro antiabbagliamento
Filtre basse luminance
Geringe Leuchtdichte-Filter
Filtro de baja luminancia

Note: the filter must be ordered together with the lighting fixture - **Nota:** il filtro deve essere ordinato congiuntamente all'apparecchio - **Note:** le filtre doit être commandé en même temps que l'appareil - **Anmerkung:** muss der Filter zusammen mit Leuchtkörper bestellt werden
Nota: el filtro debe pedirse junto con la luminaria

Drivers

Alimentatori - Alimentateurs
Netzteile - Alimentadores

on/off	dimmable
250 mA	
AL1025 (1) 40mm IP20	AL4030 (1) 55mm IP20 0/1..10V
AL9025 (1) 44mm IP67	AL4031 (1) 55mm IP20 DALI
	AL4032 (1) 55mm IP20 IGBT-TRIAC



TYRONE 2

design: Roberto Mantovani

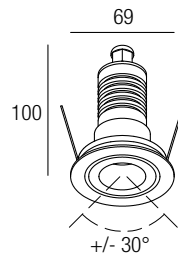

Supply current

Alimentazione
Courant d'alimentation
Stromversorgung
Corriente de alimentación

350-500 mA (V_i 2,9V)

Power

Potenza
Puissance
Bestuekung
Potencia

1-2 W

Series wiring

Cablaggio in serie
Câblage en série
Verkabelung in Serie
Cableado en serie



Photometric diagrams

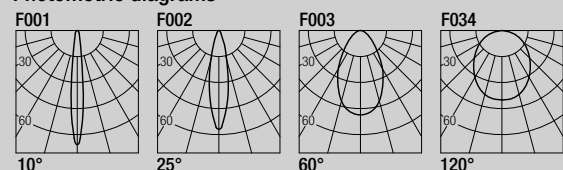

CCT/CRI/Flux

	350mA	500mA
2700K	89 lm	128 lm
3000K	93 lm	133 lm
4200K	103 lm	154 lm
6000K	114 lm	165 lm

CRI85

2-Step MacAdam

Code Construction

Costruzione del codice - Construction du code produit
Bau der Produkt-Code - Construcción del código de producto

TR2 X X X

Finishing

Finitura
Finitions
Oberflächenfinish
Acabados

	B	G	N	K	Z
White	Grey	Black	COR-TEN	INOX AISI 316L	
Bianco	Grigio	Nero		Steel	
Blanc	Gris	Noir		Acciaio	
Weiß	Grau	Schwarz		Acier	
Blanco		Negro		Stahl	
				Acero	

Color Temperature

	0	1	2	3	6	7	8
Temperatura colore	2700K	3000K	4200K	6000K	Blue	Green	Red
Température couleur					Blu	Verde	Rosso
Temperaturabhängige Farbe					Bleu	Vert	Rouge
Temperatura de color					Blau	Grün	Rot
					Azul		Rojo

Beam angle

	0	1	2	9
Apertura di fascio	10°	25°	60°	120°
Angle de faisceau				
Strahlwinkel				
Ángulo del haz				

Drivers

Alimentatori - Alimentateurs
Netzteile - Alimentadores

350 mA		500 mA	
on/off	dimnable	on/off	dimnable
AL1034 (1..11) 30mm IP20	AL4000 (1..12) 72mm IP20 PUSH 0/1..10V	AL1074 (1..7) 30mm IP20	AL4010 (1..12) 72mm IP20 PUSH 0/1..10V
AL1035 (1..11) 40mm IP20	AL4051 (2..14) 72mm IP20 DALI 2	AL1077 (1..6) 40mm IP20	AL4151 (2..14) 72mm IP20 DALI 2
AL1037 (1..16) 50mm IP20 S.P.	AL4053 (1..14) 50mm IP20 PUSH IGBT-TRIAC	AL1084 (1..11) 50mm IP20 S.P.	AL4153 (1..14) 50mm IP20 PUSH IGBT-TRIAC
AL9011 (1..12) 44mm IP67	AL8035 (4..16) IP67 DALI	AL9051 (1..11) 44mm IP67	AL8050 (4..16) IP67 DALI

Accessories

Accessori - Accessoires
Zubehör - Accesorios

CSXJ01

Recessing box
Controcassa
Boîtier d'encastrement
Eingieβgehäuse
Caja de empotrar

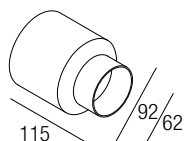

LTR201

Low luminance louver
Filtro antiabbagliamento
Filtre basse luminance
Geringe Leuchtdichte-Filter
Filtro de baja luminancia



Note: the filter must be ordered together with the lighting fixture - **Nota:** il filtro deve essere ordinato congiuntamente all'apparecchio - **Note:** le filtre doit être commandé en même temps que l'appareil - **Anmerkung:** muss der Filter zusammen mit Leuchtkörper bestellt werden
Nota: el filtro debe pedirse junto con la luminaria



TYRONE 6

design: Roberto Mantovani

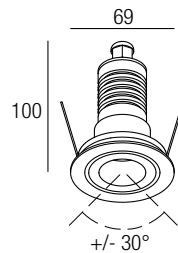

Supply current

Alimentazione
Courant d'alimentation
Stromversorgung
Corriente de alimentación

350-500 mA (V, 8, 7V)

Power

Potenza
Puissance
Bestuekung
Potencia

3-6 W

Series wiring

Cablaggio in serie
Câblage en série
Verkabelung in Serie
Cableado en serie



Photometric diagrams

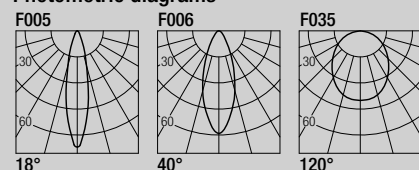

CCT/CRI/Flux

CCT	350mA	500mA
2700K	267 lm	384 lm
3000K	279 lm	400 lm
4200K	309 lm	462 lm
6000K	342 lm	495 lm

CRI85

2-Step MacAdam

Code Construction

Costruzione del codice - Construction du code produit
Bau der Produkt-Code - Construcción del código de producto

TR6 X X X

Finishing

	B	G	N	K	Z
Finitura	White	Grey	Black	COR-TEN	INOX AISI 316L
Finitions	Bianco	Grigio	Nero		Steel
Oberflächenfinish	Blanc	Gris	Noir		Acciaio
Acabados	Weiß	Grau	Schwarz		Acier
	Blanco		Negro		Stahl
					Acero

Color

Temperature	0	1	2	3	6	7	8
Temperatura colore	2700K	3000K	4200K	6000K	Blue	Green	Red
Température couleur					Blu	Verde	Rosso
Temperaturabhängige Farbe					Bleu	Vert	Rouge
Temperatura de color					Blau	Grün	Rot
					Azul		Rojo

Beam angle

	1	2	9
Apertura di fascio	18°	40°	120°
Angle de faisceau			
Strahlwinkel			
Ángulo del haz			

Accessories

Accessori - Accessoires
Zubehör - Accesorios

CSXJ01

Recessing box
Controcassa
Boîtier d'encastrement
Eingieβgehäuse
Caja de empotrar

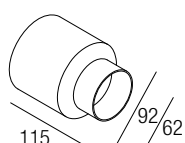

LTR601

Low luminance louver
Filtro antiabbagliamento
Filtre basse luminance
Geringe Leuchtdichte-Filter
Filtro de baja luminancia



Note: the filter must be ordered together with the lighting fixture - **Nota:** il filtro deve essere ordinato congiuntamente all'apparecchio - **Note:** le filtre doit être commandé en même temps que l'appareil - **Anmerkung:** muss der Filter zusammen mit Leuchtkörper bestellt werden
Nota: el filtro debe pedirse junto con la luminaria

Drivers

Alimentatori - Alimentateurs
Netzteile - Alimentadores

350 mA		500 mA	
on/off	dimmmable	on/off	dimmmable
AL1034 (1..3) 30mm IP20	AL4000 (1..4) 72mm IP20 PUSH 0/1..10V	AL1074 (1..2) 30mm IP20	AL4010 (1..4) 72mm IP20 PUSH 0/1..10V
AL1035 (1..3) 40mm IP20	AL4051 (1..4) 72mm IP20 DALI 2	AL1077 (1..2) 40mm IP20	AL4151 (1..4) 72mm IP20 DALI 2
AL1037 (1..5) 55mm IP20 S.P.	AL4053 (1..4) 55mm IP20 PUSH IGBT-TRIAC	AL1084 (1..3) 55mm IP20 S.P.	AL4153 (1..4) 55mm IP20 PUSH IGBT-TRIAC
AL9011 (1..4) 44mm IP67	AL8035 (2..4) IP67 DALI	AL9051 (1..3) 44mm IP67	AL8050 (2..4) IP67 DALI



TYRONE 6 EVO

design: Roberto Mantovani

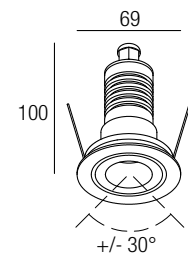

Supply current

Alimentazione
Courant d'alimentation
Stromversorgung
Corriente de alimentación

500 mA (V_i 9V)

Power

Potenza
Puissance
Bestuekung
Potencia

6 W

Series wiring

Cablaggio in serie
Câblage en série
Verkabelung in Serie
Cableado en serie



CCT/CRI/Flux

2700K — 540 lm
3000K — 600 lm
4000K — 620 lm

Photometric diagrams

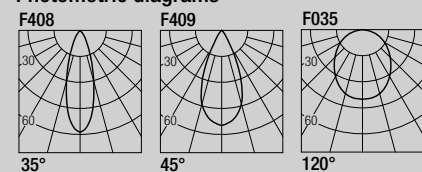

CRI98

2-Step MacAdam

Code Construction

Costruzione del codice - Construction du code produit
Bau der Produkt-Code - Construcción del código de producto

TR6E X X X

Finishing

Finitura
Finitions
Oberflächenfinish
Acabados

	B	G	N	K	Z
White	White	Grey	Black	COR-TEN	INOX AISI 316L
Bianco	Bianco	Grigio	Nero		Steel
Blanc	Blanc	Gris	Noir		Acciaio
Weiß	Weiß	Grau	Schwarz		Acier
Blanco	Blanco		Negro		Stahl
					Acero

Color Temperature

	2	3	4
Temperatura colore	2700K	3000K	4000K
Température couleur			
Temperaturabhängige Farbe			
Temperatura de color			

Beam angle

	S	M	W
Apertura di fascio	35°	45°	120°
Angle de faisceau			
Strahlwinkel			
Ángulo del haz			

Accessories

Accessori - Accessoires
Zubehör - Accesorios

CSXJ01

Recessing box
Controcassa
Boîtier d'encastrement
Eingießgehäuse
Caja de empotrar

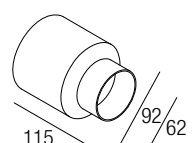

LTR6E01

Low luminance louver
Filtro antiabbagliamento
Filtre basse luminance
Geringe Leuchtdichte-Filter
Filtro de baja luminancia



Note: the filter must be ordered together with the lighting fixture - **Nota:** il filtro deve essere ordinato congiuntamente all'apparecchio - **Note:** le filtre doit être commandé en même temps que l'appareil - **Anmerkung:** muss der Filter zusammen mit Leuchtkörper bestellt werden
Nota: el filtro debe pedirse junto con la luminaria

Drivers

Alimentatori - Alimentateurs
Netzteile - Alimentadores

500 mA	on/off	dimmable
AL1074 (1..2)	30mm IP20	AL4010 (1..4) 72mm IP20 PUSH 0/1..10V
AL1077 (1..2)	40mm IP20	AL4151 (1..4) 72mm IP20 DALI 2
AL1084 (1..3)	55mm IP20 S.P.	AL4153 (1..4) 56mm IP20 PUSH IGBT-TRIAC
AL9051 (1..3)	44mm IP67	AL8050 (2..4) IP67 DALI

TYRONE 724

design: Roberto Mantovani

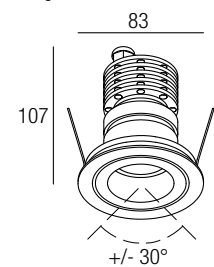

Supply current

Alimentazione
Courant d'alimentation
Stromversorgung
Corriente de alimentación

24 VDC

Power

Potenza
Puissance
Bestuekung
Potencia

7 W

Parallel wiring

Cablaggio in parallelo
Câblage en parallèle
Verkabelung in parallel
Cableado en paralelo



Photometric diagrams

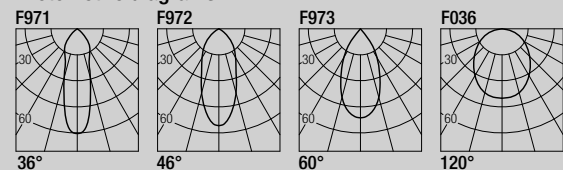

CCT/CRI/Flux

	CRI85	CRI93
2700K	630 lm	590 lm
3000K	700 lm	650 lm
4000K	730 lm	670 lm

CRI85 - CRI93

2-Step MacAdam

Code Construction

Costruzione del codice - Construction du code produit
Bau der Produkt-Code - Construcción del código de producto

TR24 X X X X

Beam angle	S	M	W	X
Apertura di fascio Angle de faisceau Strahlwinkel Angulo del haz	36°	46°	60°	120°

Finishing	B	G	N	K	Z
Finitura Finitions Oberflächenfinish Acabados	White Bianco Weiß Blanco	Grey Grigio Gris Grau	Black Nero Noir Schwarz Negro	COR-TEN	INOX AISI 316L Steel Acciaio Acier Stahl Acero

CRI	8	9
	85	93

Color Temperature	2	3	4
Temperatura colore Température couleur Temperaturabhängige Farbe Temperatura de color	2700K	3000K	4000K

Accessories

Accessori - Accessoires
Zubehör - Accesorios

CSSL01

Recessing box
Controcassa
Boîtier d'encastrement
Eingießgehäuse
Caja de empotrar

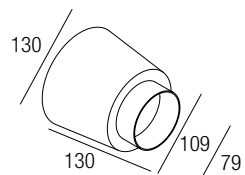

LTR2401

Low luminance lower
Filtro antiabbagliamento
Filtre basse luminance
Geringe Leuchtdichte-Filter
Filtro de baja luminancia

Note: the filter must be ordered together with the lighting fixture - **Nota:** il filtro deve essere ordinato congiuntamente all'apparecchio - **Note:** le filtre doit être commandé en même temps que l'appareil - **Anmerkung:** muss der Filter zusammen mit Leuchtkörper bestellt werden
Nota: el filtro debe pedirse junto con la luminaria

Drivers

Alimentatori - Alimentateurs
Netzteile - Alimentadores

24 VDC	on/off	dimming module	dimmmable
AL2012 (1..3) 60mm IP20	AL7035 IP20 PUSH DALI 0/1..10V	AL5012 (1..3) 45mm IP20 PUSH DALI 0/1..10V	AL8012 (1..3) IP67 DALI
AL2031 (1..10) 70mm IP20			
AL2040 (1..21) 80mm IP20			
AL9212 (1..2) 110mm IP67			
AL9231 (1..10) 85mm IP67			
AL9240 (1..21) 85mm IP67			

Note: dimming module AL7035 to be used in combination with an on/off 24VDC power supply
Nota: modulo di dimmerazione AL7035 da utilizzare in combinazione con un alimentatore on/off 24VDC
Note: module de variation AL7035 d'intensité à utiliser en combinaison avec une alimentation on/off 24VDC
Anmerkung: Dimmmodul AL7035 zur Verwendung in Kombination mit einem on/off 24VDC-Netzteil
Nota: módulo de regulación AL7035 se utiliza en combinación con una fuente de alimentación on/off 24VDC



TYRONE 10

design: Roberto Mantovani

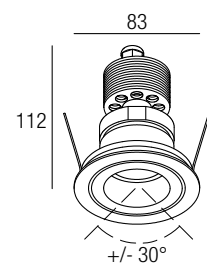

Supply current

Alimentazione
 Courant d'alimentation
 Stromversorgung
 Corriente de alimentación

250 mA (V, 36V)

Power

Potenza
 Puissance
 Bestuekung
 Potencia

10 W



CCT/CRI/Flux

	CRI85	CRI93
2700K	890 lm	840 lm
3000K	1000 lm	930 lm
4000K	1040 lm	960 lm

Photometric diagrams

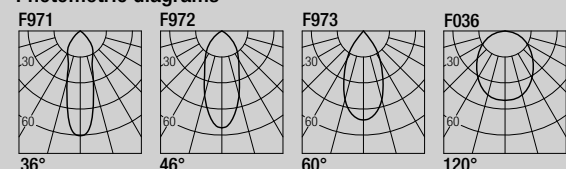

CRI85 - CRI93
 2-Step MacAdam

Code Construction

Costruzione del codice - Construction du code produit
 Bau der Produkt-Code - Construcción del código de producto

TR1 X X X X

Beam angle	S	M	W	X
Apertura di fascio	36°	46°	60°	120°
Angle de faisceau				
Strahlwinkel				
Ángulo del haz				

Finishing	B	G	N	K	Z
Finitura	White	Grey	Black	COR-TEN	INOX AISI 316L
Finitions	Bianco	Grigio	Nero		Steel
Oberflächenfinish	Blanc	Gris	Noir		Acciaio
Acabados	Weiß	Grau	Schwarz		Acier
	Blanco		Negro		Stahl
					Aceró

CRI	8	9
	85	93

Color Temperature	2	3	4
Temperatura colore	2700K	3000K	4000K
Température couleur			
Temperaturabhängige Farbe			
Temperatura de color			

Accessories

Accessori - Accessoires
 Zubehör - Accesorios

CSSL01

Recessing box
 Controcassa
 Boîtier d'encastrement
 Eingießgehäuse
 Caja de empotrar

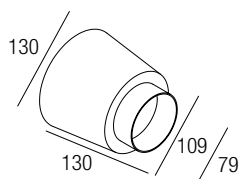

LTR101

Low luminance louver
 Filtro antiabbagliamento
 Filtre basse luminance
 Geringe Leuchtdichte-Filter
 Filtro de baja luminancia



Note: the filter must be ordered together with the lighting fixture - **Nota:** il filtro deve essere ordinato congiuntamente all'apparecchio - **Note:** le filtre doit être commandé en même temps que l'appareil - **Anmerkung:** muss der Filter zusammen mit Leuchtkörper bestellt werden
Nota: el filtro debe pedirse junto con la luminaria



Drivers

Alimentatori - Alimentateurs
 Netzteile - Alimentadores

on/off	dimmable
AL1025 (1) 40mm IP20	AL4030 (1) 55mm IP20 0/1..10V
AL9025 (1) 44mm IP67	AL4031 (1) 55mm IP20 DALI
	AL4032 (1) 55mm IP20 IGBT-TRIAC

TYLA

design: Roberto Mantovani

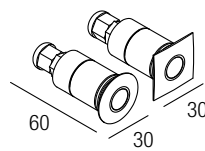

Supply current

Alimentazione
Courant d'alimentation
Stromversorgung
Corriente de alimentación

350 mA (V_i 2,9V)

Power

Potenza
Puissance
Bestuekung
Potencia

1 W

Series wiring

Cablaggio in serie
Câblage en série
Verkabelung in Serie
Cableado en serie

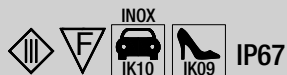

Photometric diagrams

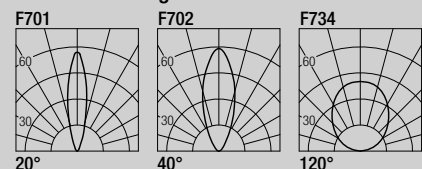

CCT/CRI/Flux

2700K	101 lm
3000K	109 lm
4200K	116 lm
6000K	132 lm

CRI85

2-Step MacAdam

Code Construction

Costruzione del codice - Construction du code produit
Bau der Produkt-Code - Construcción del código de producto

TY X X X X

Finishing

	G	N	K	Z
Finitura	Grey	Black	COR-TEN	INOX AISI 316L
Finitions	Grigio	Nero		Steel
Oberflächenfinish	Gris	Noir		Acciaio
Acabados	Grau	Schwarz		Acier
		Negro		Stahl
				Acero

Color Temperature

	0	1	2	3	6	7	8
Temperatura colore	2700K	3000K	4200K	6000K	Blue	Green	Red
Température couleur					Blu	Verde	Rosso
Temperaturabhängige Farbe					Bleu	Vert	Rouge
Temperatura de color					Blau	Grün	Rot
					Azul		Rojo

Beam angle

	1	2	9
Apertura di fascio	20°	40°	120°
Angle de faisceau			
Strahlwinkel			
Ángulo del haz			

Shape

	1	2
Forma	Round	Square
Forme	Tondo	Quadro
Form	Ronde	Carré
	Runde	Quadrat
	Redondo	Cuadrado

Accessories

Accessori - Accessoires
Zubehör - Accesorios

CSTY01

Recessing box
Controcassa
Boîtier d'encastrement
Eingieβgehäuse
Caja de empotrar

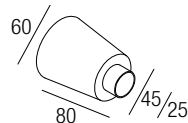

Note: cable cut to measure on request

Nota: cavo a misura disponibile su richiesta

Note: câble sur mesure disponible sur demande

Anmerkung: kundenspezifisches Kabel auf Anfrage erhältlich

Nota: cable a medida disponible a petición

Drivers

Alimentatori - Alimentateurs
Netzteile - Alimentadores

350 mA	on/off	dimmable
AL1034 (1..11)	30mm IP20	AL4000 (1..12)
AL1035 (1..11)	40mm IP20	AL4051 (2..14)
AL1037 (1..16)	55mm IP20 S.P.	AL4053 (1..14)
AL9011 (1..12)	44mm IP67	AL8035 (4..16)
		IP67 DALI

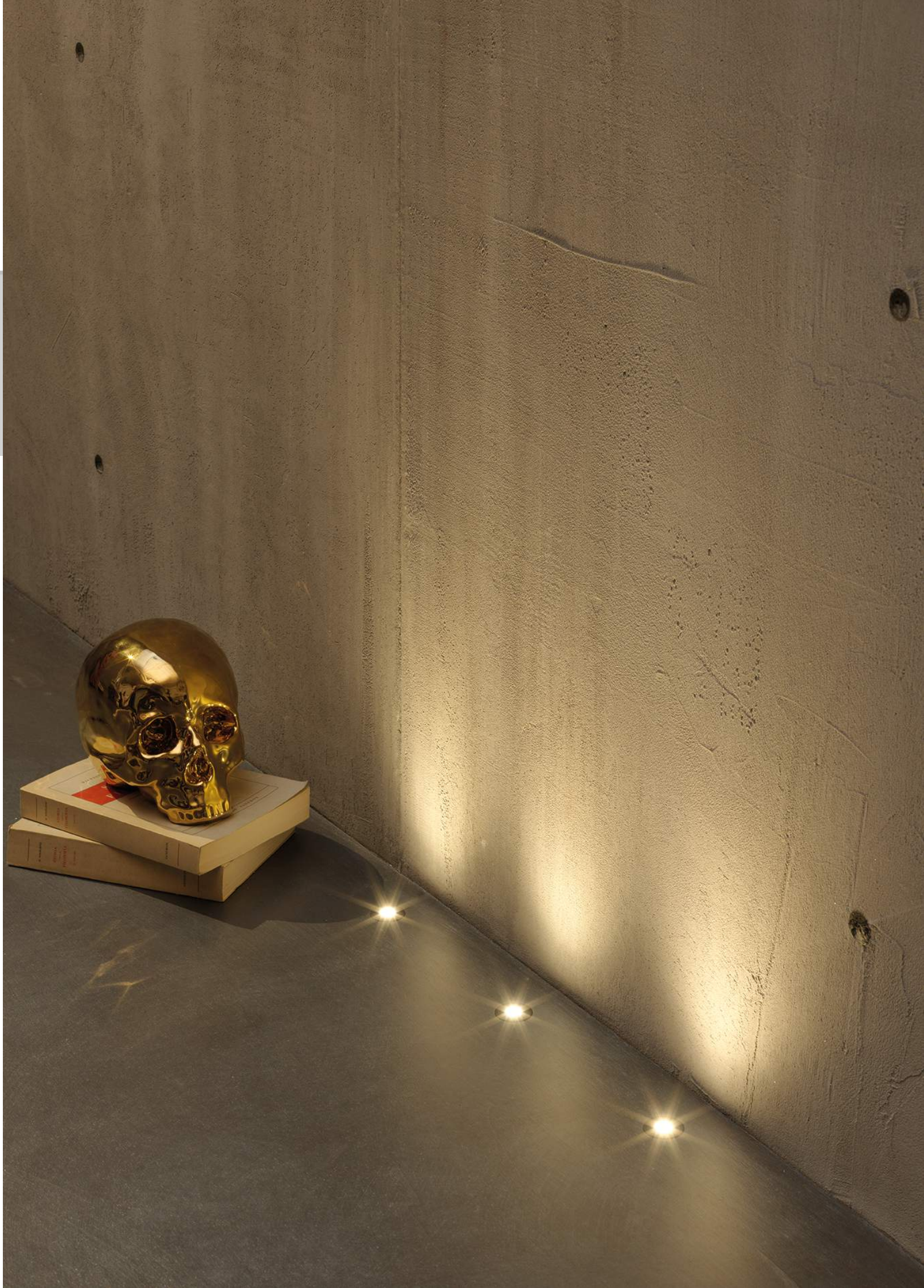

LANDA

design: Roberto Mantovani

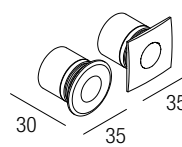

Supply current

Alimentazione
Courant d'alimentation
Stromversorgung
Corriente de alimentación

350 mA (V_f 2,9V)

Power

Potenza
Puissance
Bestuekung
Potencia

1 W

Series wiring

Cablaggio in serie
Câblage en série
Verkabelung in Serie
Cableado en serie

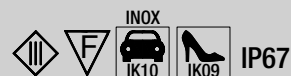

CCT/CRI/Flux

2700K — 101 lm
3000K — 109 lm
4200K — 116 lm
6000K — 132 lm

CRI85

2-Step MacAdam

Photometric diagrams

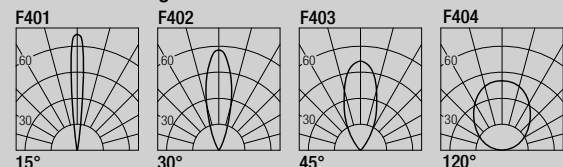

Code Construction

Costruzione del codice - Construction du code produit
Bau der Produkt-Code - Construcción del código de producto

LA X X X X

Finishing	G	N	K	Z			
	Grey Grigio Gris Grau	Black Nero Noir Schwarz Negro	COR-TEN	INOX AISI 316L Steel Acciaio Acier Stahl Acero			
Color Temperature	0	1	2	3	6	7	8
	2700K	3000K	4200K	6000K	Blue Blu Bleu Blau Azul	Green Verde Vert Grün	Red Rosso Rouge Rot Rojo
Beam angle	1	2	3	9			
	15°	30°	45°	120°			
Shape	1	2					
	Round Tondo Ronde Runde Redondo	Square Quadro Carré Quadrat Cuadrado					

Accessories

Accessori - Accessoires
Zubehör - Accesorios

CSLN01

Recessing box
Controcassa
Boîtier d'encastrement
Eingießgehäuse
Caja de empotrar

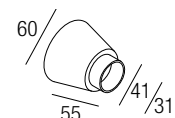

LLA01

Low luminance louver
Filtro antiabbagliamento
Filtre basse luminance
Geringe Leuchtdichte-Filter
Filtro de baja luminancia



Note: the filter must be ordered together with the lighting fixture - **Nota:** il filtro deve essere ordinato congiuntamente all'apparecchio - **Note:** le filtre doit être commandé en même temps que l'appareil - **Anmerkung:** muss der Filter zusammen mit Leuchtkörper bestellt werden
Nota: el filtro debe pedirse junto con la luminaria

Note: cable cut to measure on request
Nota: cavo a misura disponibile su richiesta
Note: câble sur mesure disponible sur demande
Anmerkung: kundenspezifisches Kabel auf Anfrage erhältlich
Nota: cable a medida disponible a petición

Drivers

Alimentatori - Alimentateurs
Netzteile - Alimentadores

on/off	dimmable
350 mA	
AL1034 (1..11) 30mm IP20	AL4000 (1..12) 72mm IP20 PUSH 0/1..10V
AL1035 (1..11) 40mm IP20	AL4051 (2..14) 72mm IP20 DALI 2
AL1037 (1..16) 55mm IP20 S.P.	AL4053 (1..14) 56mm IP20 PUSH IGBT-TRIAC
AL9011 (1..12) 44mm IP67	AL8035 (4..16) IP67 DALI



FATBOY 2

design: Roberto Mantovani

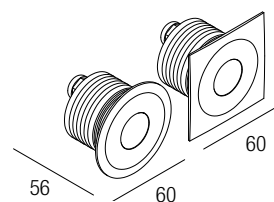

Supply current

Alimentazione
 Courant d'alimentation
 Stromversorgung
 Corriente de alimentación
350-500 mA (V, 2,9V)

Power

Potenza
 Pouissance
 Bestuekung
 Potencia
1-2 W

Series wiring

Cablaggio in serie
 Câblage en série
 Verkabelung in Serie
 Cableado en serie

- [DATASHEET ▶](#)
- [INSTALLATION MANUAL ▶](#)
- [CERTIFICATIONS ▶](#)
- [LDT-IES ▶](#)
- [DRAWINGS ▶](#)

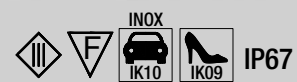

Photometric diagrams

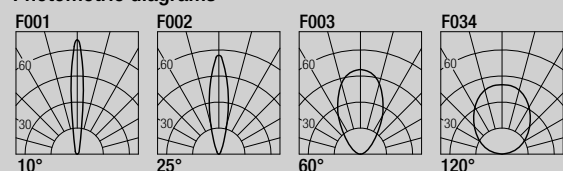

CCT/CRI/Flux

	350mA	500mA
2700K	89 lm	128 lm
3000K	93 lm	133 lm
4200K	103 lm	154 lm
6000K	114 lm	165 lm

CRI85

2-Step MacAdam

Code Construction

Costruzione del codice - Construction du code produit
 Bau der Produkt-Code - Construcción del código de producto

FB1 X X X X

Finishing	G	N	K	Z			
Finitura Finitions Oberflächenfinish Acabados	Grey Grigio Gris Grau	Black Nero Noir Schwarz Negro	COR-TEN	INOX AISI 316L Steel Acciaio Acier Stahl Acero			
Color Temperature	0	1	2	3	6	7	8
Temperatura colore Température couleur Temperaturabhängige Farbe Temperatura de color	2700K	3000K	4200K	6000K	Blue Blu Bleu Blau Azul	Green Verde Vert Grün	Red Rosso Rouge Rot Rojo
Beam angle	0	1	2	9			
Apertura di fascio Angle de faisceau Strahlwinkel Angulo del haz	10°	25°	60°	120°			
Shape	1	2					
Forma Forme Form	Round Tondo Ronde Runde Redondo	Square Quadro Carré Quadrat Cuadrado					

Accessories

Accessori - Accessoires
 Zubehör - Accesorios

CSFB01

Recessing box
 Controcassa
 Boîtier d'encastrement
 Eingieβgehäuse
 Caja de empotrar

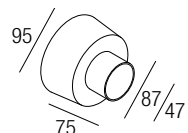

Note: cable cut to measure on request
Nota: cavo a misura disponibile su richiesta
Note: câble sur mesure disponible sur demande
Anmerkung: kundenspezifisches Kabel auf Anfrage erhältlich
Nota: cable a medida disponible a petición

Drivers

Alimentatori - Alimentateurs
 Netzteile - Alimentadores

350 mA	on/off	dimmable
AL1034 (1.11) 30mm IP20	AL4000 (1.12) 72mm IP20 PUSH 0/1..10V	
AL1035 (1.11) 40mm IP20	AL4051 (2.14) 72mm IP20 DALI 2	
AL1037 (1.16) 55mm IP20 S.P.	AL4053 (1.14) 56mm IP20 PUSH IGBT-TRIAC	
AL9011 (1.12) 44mm IP67	AL8035 (4.16) IP67 DALI	
500 mA	on/off	dimmable
AL1074 (1.7) 30mm IP20	AL4010 (1.12) 72mm IP20 PUSH 0/1..10V	
AL1077 (1.6) 40mm IP20	AL4151 (2.14) 72mm IP20 DALI 2	
AL1084 (1.11) 55mm IP20 S.P.	AL4153 (1.14) 56mm IP20 PUSH IGBT-TRIAC	
AL9051 (1.11) 44mm IP67	AL8050 (4.16) IP67 DALI	



FROG

design: Roberto Mantovani

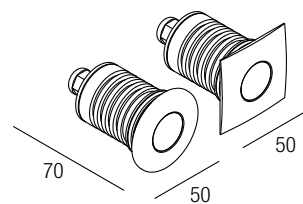

Supply current
 Alimentazione
 Courant d'alimentation
 Stromversorgung
 Corriente de alimentación
24 VDC

Power
 Potenza
 Pouissance
 Bestuekung
 Potencia
2 W

Parallel wiring
 Cablaggio in parallelo
 Câblage en parallèle
 Verkabelung in parallel
 Cableado en paralelo

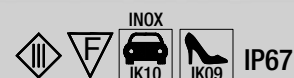

CCT/CRI/Flux

2700K — 128 lm
 3000K — 133 lm
 4200K — 154 lm

Photometric diagrams

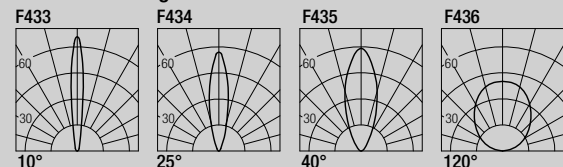

CRI85
 2-Step MacAdam

Code Construction

Costruzione del codice - Construction du code produit
 Bau der Produkt-Code - Construcción del código de producto

FR X X X X

Beam angle	S	M	W	X
Apertura di fascio Angle de faisceau Strahlwinkel Angulo del haz	10°	25°	40°	120°

Finishing	G	N	K	Z
Finitura Finitions Oberflächenfinish Acabados	Grey Grigio Gris Grau	Black Nero Noir Schwarz Negro	COR-TEN	INOX AISI 316L Steel Acciaio Acier Stahl Acero

Color Temperature	2	3	4
Temperatura colore Température couleur Temperaturabhängige Farbe Temperatura de color	2700K	3000K	4200K

Shape	1	2
Forma Forme Form	Round Tondo Ronde Runde Redondo	Square Quadro Carré Quadrat Cuadrado

Accessories

Accessori - Accessoires
 Zubehör - Accesorios

CSXT01

Recessing box
 Controcassa
 Boîtier d'encastrement
 Eingieβgehäuse
 Caja de empotrar

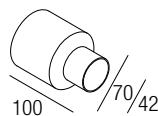

LFR01

Low luminance louver
 Filtro antiabbagliamento
 Filtre basse luminance
 Geringe Leuchtdichte-Filter
 Filtro de baja luminancia



Note: the filter must be ordered together with the lighting fixture - **Nota:** il filtro deve essere ordinato congiuntamente all'apparecchio - **Note:** le filtre doit être commandé en même temps que l'appareil - **Anmerkung:** muss der Filter zusammen mit Leuchtkörper bestellt werden
Nota: el filtro debe pedirse junto con la luminaria

Note: cable cut to measure on request
Nota: cavo a misura disponibile su richiesta
Note: câble sur mesure disponible sur demande
Anmerkung: kundenspezifisches Kabel auf Anfrage erhältlich
Nota: cable a medida disponible a petición

Drivers

Alimentatori - Alimentateurs
 Netzteile - Alimentadores

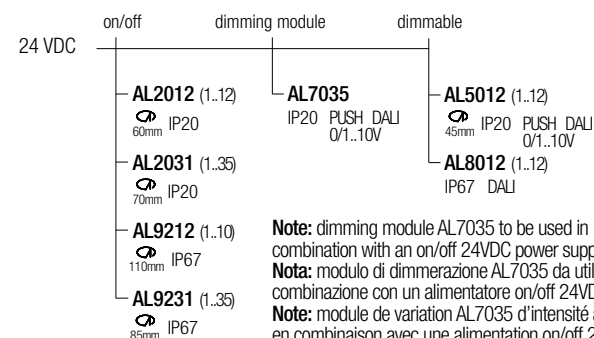

Note: dimming module AL7035 to be used in combination with an on/off 24VDC power supply
Nota: modulo di dimmerazione AL7035 da utilizzare in combinazione con un alimentatore on/off 24VDC
Note: module de variation AL7035 d'intensité à utiliser en combinaison avec une alimentation on/off 24VDC
Anmerkung: Dimmmodul AL7035 zur Verwendung in Kombination mit einem on/off 24VDC-Netzteil
Nota: módulo de regulación AL7035 se utiliza en combinación con una fuente de alimentación on/off 24VDC



TERA 2

design: Roberto Mantovani

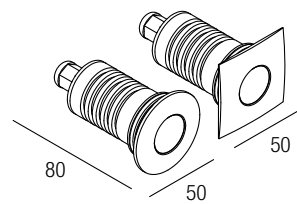

Supply current
Alimentazione
Courant d'alimentation
Stromversorgung
Corriente de alimentación
350-500 mA (V, 2,9V)

Power
Potenza
Puissance
Bestuekung
Potencia
1-2 W

Series wiring
Cablaggio in serie
Câblage en série
Verkabelung in Serie
Cableado en serie

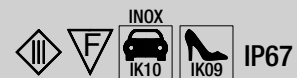

Photometric diagrams

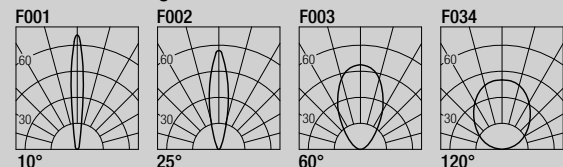

CCT/CRI/Flux

	350mA	500mA
2700K	89 lm	128 lm
3000K	93 lm	133 lm
4200K	103 lm	154 lm
6000K	114 lm	165 lm

CRI85
2-Step MacAdam



Code Construction

Costruzione del codice - Construction du code produit
Bau der Produkt-Code - Construcción del código de producto

XT1 X X X X

Finishing

	G	N	K	Z
Finitura Finitions Oberflächenfinish Acabados	Grey Grigio Gris Grau	Black Nero Noir Schwarz Negro	COR-TEN	INOX AISI 316L Steel Acciaio Acier Stahl Acero

Color Temperature

	0	1	2	3	6	7	8
Temperatura colore Température couleur Temperaturabhängige Farbe Temperatura de color	2700K	3000K	4200K	6000K	Blue Blu Bleu Blau Azul	Green Verde Vert Grün	Red Rosso Rouge Rot Rojo

Beam angle

	0	1	2	9
Apertura di fascio Angle de faisceau Strahlwinkel Angulo del haz	10°	25°	60°	120°

Shape

	1	2
Forma Forme Form	Round Tondo Ronde Runde Redondo	Square Quadro Carré Quadrat Cuadrado

Accessories

Accessori - Accessoires
Zubehör - Accesorios

CSXT01

Recessing box
Controcassa
Boîtier d'encastrement
Eingießgehäuse
Caja de empotrar

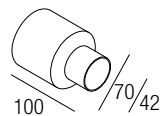

LXT101

Low luminance louver
Filtro antiabbagliamento
Filtre basse luminance
Geringe Leuchtdichte-Filter
Filtro de baja luminancia



Note: the filter must be ordered together with the lighting fixture - **Nota:** il filtro deve essere ordinato congiuntamente all'apparecchio - **Note:** le filtre doit être commandé en même temps que l'appareil - **Anmerkung:** muss der Filter zusammen mit Leuchtkörper bestellt werden
Nota: el filtro debe pedirse junto con la luminaria

Note: cable cut to measure on request
Nota: cavo a misura disponibile su richiesta
Note: câble sur mesure disponible sur demande
Anmerkung: kundenspezifisches Kabel auf Anfrage erhältlich
Nota: cable a medida disponible a petición

Drivers

Alimentatori - Alimentateurs
Netzteile - Alimentadores

350 mA		500 mA	
on/off	dimmable	on/off	dimmable
AL1034 (1.11) 30mm IP20	AL4000 (1.12) 72mm IP20 PUSH 0/1..10V	AL1074 (1.7) 30mm IP20	AL4010 (1.12) 72mm IP20 PUSH 0/1..10V
AL1035 (1.11) 40mm IP20	AL4051 (2.14) 72mm IP20 DALI 2	AL1077 (1.6) 40mm IP20	AL4151 (2.14) 72mm IP20 DALI 2
AL1037 (1.16) 55mm IP20 S.P.	AL4053 (1.14) 56mm IP20 PUSH IGBT-TRIAC	AL1084 (1.11) 55mm IP20 S.P.	AL4153 (1.14) 56mm IP20 PUSH IGBT-TRIAC
AL9011 (1.12) 44mm IP67	AL8035 (4.16) IP67 DALI	AL9051 (1.11) 44mm IP67	AL8050 (4.16) IP67 DALI



TERA 6

design: Roberto Mantovani

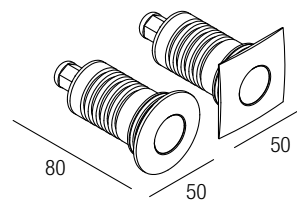

Supply current
Alimentazione
Courant d'alimentation
Stromversorgung
Corriente de alimentación
350-500 mA (V, 8, 7V)

Power
Potenza
Puissance
Bestuekung
Potencia
3-6 W

Series wiring
Cablaggio in serie
Câblage en série
Verkabelung in Serie
Cableado en serie

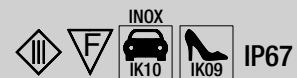

Photometric diagrams

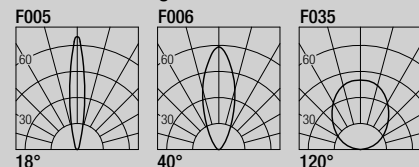

CCT/CRI/Flux	350mA		500mA	
	2700K	267 lm	384 lm	
3000K	279 lm	400 lm		
4200K	309 lm	462 lm		
6000K	342 lm	495 lm		

CRI85
2-Step MacAdam



Code Construction

Costruzione del codice - Construction du code produit
Bau der Produkt-Code - Construcción del código de producto

XT2 X X X X

Finishing	G	N	K	Z			
Finitura Finitions Oberflächenfinish Acabados	Grey Grigio Gris Grau	Black Nero Noir Schwarz Negro	COR-TEN	INOX AISI 316L Steel Acciaio Acier Stahl Acero			
Color Temperature	0	1	2	3	6	7	8
Temperatura colore Température couleur Temperaturabhängige Farbe Temperatura de color	2700K	3000K	4200K	6000K	Blue Blu Bleu Blau Azul	Green Verde Vert Grün	Red Rosso Rouge Rot Rojo
Beam angle	1	2	9				
Apertura di fascio Angle de faisceau Strahlwinkel Ángulo del haz	18°	40°	120°				
Shape	1	2					
Forma Forme Form	Round Tondo Ronde Runde Redondo	Square Quadro Carré Quadrat Cuadrado					

Accessories

Accessori - Accessoires
Zubehör - Accesorios

CSXT01

Recessing box
Controcassa
Boîtier d'encastrement
Eingießgehäuse
Caja de empotrar

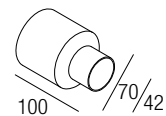

LXT201

Low luminance louver
Filtro antiabbagliamento
Filtre basse luminance
Geringe Leuchtdichte-Filter
Filtro de baja luminancia



Nota: il filtro deve essere ordinato congiuntamente all'apparecchio - **Note:** the filter must be ordered together with the lighting fixture - **Note:** le filtre doit être commandé en même temps que l'appareil - **Anmerkung:** muss der Filter zusammen mit Leuchtkörper bestellt werden
Nota: el filtro debe pedirse junto con la luminaria

Note: cable cut to measure on request
Nota: cavo a misura disponibile su richiesta
Note: câble sur mesure disponible sur demande
Anmerkung: kundenspezifisches Kabel auf Anfrage erhältlich
Nota: cable a medida disponible a petición

Drivers

Alimentatori - Alimentateurs
Netzteile - Alimentadores

350 mA		500 mA	
on/off	dimmmable	on/off	dimmmable
AL1034 (1..3) 30mm IP20	AL4000 (1..4) 72mm IP20 PUSH 0/1..10V	AL1074 (1..2) 30mm IP20	AL4010 (1..4) 72mm IP20 PUSH 0/1..10V
AL1035 (1..3) 40mm IP20	AL4051 (1..4) 72mm IP20 DALI 2	AL1077 (1..2) 40mm IP20	AL4151 (1..4) 72mm IP20 DALI 2
AL1037 (1..5) 55mm IP20 S.P.	AL4053 (1..4) 56mm PUSH IGBT-TRIAC	AL1084 (1..3) 55mm IP20 S.P.	AL4153 (1..4) 56mm IP20 PUSH IGBT-TRIAC
AL9011 (1..4) 44mm IP67	AL8035 (2..4) IP67 DALI	AL9051 (1..3) 44mm IP67	AL8050 (2..4) IP67 DALI



TERA 6 EVO

design: Roberto Mantovani

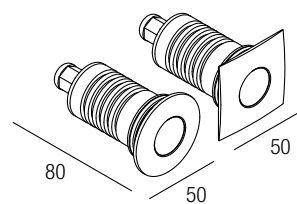

Supply current
Alimentazione
Courant d'alimentation
Stromversorgung
Corriente de alimentación
500 mA (V_i 9V)

Power
Potenza
Puissance
Bestuekung
Potencia
6 W

Series wiring
Cablaggio in serie
Câblage en série
Verkabelung in Serie
Cableado en serie

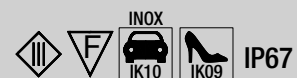

Photometric diagrams

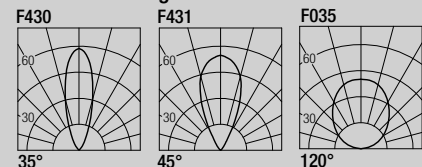

CCT/CRI/Flux

2700K — 540 lm
3000K — 600 lm
4000K — 620 lm

CRI98
2-Step MacAdam



Code Construction

Costruzione del codice - Construction du code produit
Bau der Produkt-Code - Construcción del código de producto

XTE X X X X

Finishing

	G	N	K	Z
Finitura Finitions Oberflächenfinish Acabados	Grey Grigio Gris Grau	Black Nero Noir Schwarz Negro	COR-TEN	INOX AISI 316L Steel Acciaio Acier Stahl Acero

Color Temperature

	2	3	4
Temperatura colore Température couleur Temperaturabhängige Farbe Temperatura de color	2700K	3000K	4000K

Beam angle

	S	M	W
Apertura di fascio Angle de faisceau Strahlwinkel Ángulo del haz	35°	45°	120°

Shape

	1	2
Forma Forme Form	Round Tondo Ronde Runde Redondo	Square Quadro Carré Quadrat Cuadrado

Accessories

Accessori - Accessoires
Zubehör - Accesorios

CSXT01

Recessing box
Controcassa
Boîtier d'encastrement
Eingieβgehäuse
Caja de empotrar

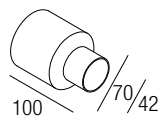

LXTE01

Low luminance louver
Filtro antiabbagliamento
Filtre basse luminance
Geringe Leuchtdichte-Filter
Filtro de baja luminancia



Note: the filter must be ordered together with the lighting fixture - **Nota:** il filtro deve essere ordinato congiuntamente all'apparecchio - **Note:** le filtre doit être commandé en même temps que l'appareil - **Anmerkung:** muss der Filter zusammen mit Leuchtkörper bestellt werden
Nota: el filtro debe pedirse junto con la luminaria

Note: cable cut to measure on request
Nota: cavo a misura disponibile su richiesta
Note: câble sur mesure disponible sur demande
Anmerkung: kundenspezifisches Kabel auf Anfrage erhältlich
Nota: cable a medida disponible a petición

Drivers

Alimentatori - Alimentateurs
Netzteile - Alimentadores

500 mA	on/off	dimnable
AL1074 (1..2) 30mm IP20	AL4010 (1..4) 72mm IP20 PUSH 0/1..10V	
AL1077 (1..2) 40mm IP20	AL4151 (1..4) 72mm IP20 DALI2	
AL1084 (1..3) 55mm IP20 S.P.	AL4153 (1..4) 56mm IP20 PUSH IGBT-TRIAC	
AL9051 (1..3) 44mm IP67	AL8050 (2..4) IP67 DALI	



TERA 7

design: Roberto Mantovani

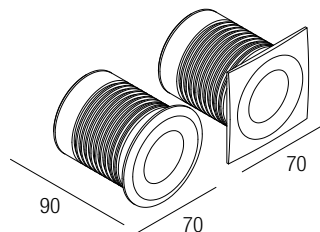

Supply current

Alimentazione
 Courant d'alimentation
 Stromversorgung
 Corriente de alimentación
350 mA (V, 20, 3V)

Power

Potenza
 Pouissance
 Bestuekung
 Potencia
7 W

Series wiring

Cablaggio in serie
 Câblage en série
 Verkabelung in Serie
 Cableado en serie

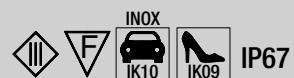

CCT/CRI/Flux

2700K — 623 lm
 3000K — 651 lm
 4200K — 721 lm
 6000K — 798 lm

CRI85
 2-Step MacAdam

Photometric diagrams

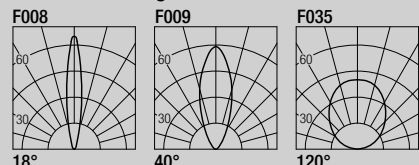

Code Construction

Costruzione del codice - Construction du code produit
 Bau der Produkt-Code - Construcción del código de producto

XT3 X X X X

Finishing	G	N	K	Z			
Finitura Finitions Oberflächenfinish Acabados	Grey Grigio Gris Grau	Black Nero Noir Schwarz Negro	COR-TEN	INOX AISI 316L Steel Acciaio Acier Stahl Acero			
Color Temperature	0	1	2	3	6	7	8
Temperatura colore Température couleur Temperaturabhängige Farbe Temperatura de color	2700K	3000K	4200K	6000K	Blue Blu Bleu Blau Azul	Green Verde Vert Grün	Red Rosso Rouge Rot Rojo
Beam angle	1	2	9				
Apertura di fascio Angle de faisceau Strahlwinkel Ángulo del haz	18°	40°	120°				
Shape	1	2					
Forma Forme Form	Round Tondo Ronde Runde Redondo	Square Quadro Carré Quadrat Cuadrado					

Accessories

Accessori - Accessoires
 Zubehör - Accesorios

CSXJ01

Recessing box
 Controcassa
 Boîtier d'encastrement
 Eingießgehäuse
 Caja de empotrar

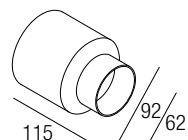

LXT301

Low luminance louver
 Filtro antiabbagliamento
 Filtre basse luminance
 Geringe Leuchtdichte-Filter
 Filtro de baja luminancia



Note: the filter must be ordered together with the lighting fixture - **Nota:** il filtro deve essere ordinato congiuntamente all'apparecchio - **Note:** le filtre doit être commandé en même temps que l'appareil - **Anmerkung:** muss der Filter zusammen mit Leuchtkörper bestellt werden
Nota: el filtro debe pedirse junto con la luminaria

Note: cable cut to measure on request
Nota: cavo a misura disponibile su richiesta
Note: câble sur mesure disponible sur demande
Anmerkung: kundenspezifisches Kabel auf Anfrage erhältlich
Nota: cable a medida disponible a petición

Drivers

Alimentatori - Alimentateurs
 Netzteile - Alimentadores

350 mA	on/off	dimmmable	500 mA	on/off	dimmmable
AL1034 (1) 30mm IP20	AL4000 (1) 72mm IP20 PUSH 0/1..10V	AL1074 (1) 30mm IP20	AL4010 (1) 72mm IP20 PUSH 0/1..10V		
AL1035 (1) 40mm IP20	AL4051 (1) 72mm IP20 DALI 2	AL1084 (1) 55mm IP20 S.P.	AL4151 (1) 72mm IP20 DALI 2		
AL1037 (1..2) 55mm IP20 S.P.	AL4053 (1) 56mm IP20 PUSH IGBT-TRIAC	AL9051 (1) 44mm IP67	AL4153 (1) 56mm IP20 PUSH IGBT-TRIAC		
AL9011 (1) 44mm IP67	AL8035 (1..2) IP67 DALI		AL8050 (1..2) IP67 DALI		



TERA 524

design: Roberto Mantovani

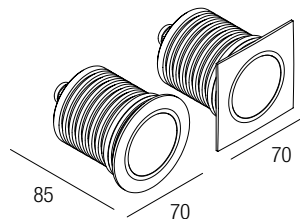

Supply current
Alimentazione
Courant d'alimentation
Stromversorgung
Corriente de alimentación
24 VDC

Power
Potenza
Puissance
Bestuekung
Potencia
6 W

Parallel wiring
Cablaggio in parallelo
Câblage en parallèle
Verkabelung in parallel
Cableado en paralelo

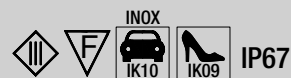

Photometric diagrams

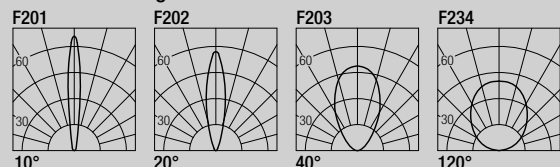

CCT/CRI/Flux

2700K	384 lm
3000K	400 lm
4200K	462 lm
6000K	495 lm

CRI85
2-Step MacAdam

Code Construction

Costruzione del codice - Construction du code produit
Bau der Produkt-Code - Construcción del código de producto

XT5 X X X X

Finishing	G	N	K	Z			
Finitura Finitions Oberflächenfinish Acabados	Grey Grigio Gris Grau	Black Nero Noir Schwarz Negro	COR-TEN	INOX AISI 316L Steel Acciaio Acier Stahl Acero			
Color Temperature	0	1	2	3	6	7	8
Temperatura colore Température couleur Temperaturabhängige Farbe Temperatura de color	2700K	3000K	4200K	6000K	Blue Blu Bleu Blau Azul	Green Verde Vert Grün	Red Rosso Rouge Rot Rojo
Beam angle	0	1	2	9			
Apertura di fascio Angle de faisceau Strahlwinkel Ángulo del haz	10°	20°	40°	120°			
Shape	1	2					
Forma Forme Form	Round Tondo Ronde Runde Redondo	Square Quadro Carré Cuadrat Cuadrado					

Accessories

Accessori - Accessoires
Zubehör - Accesorios

CSXJ01

Recessing box
Controcassa
Boîtier d'encastrement
Eingießegehäuse
Caja de empotrar

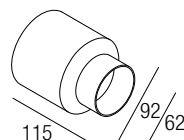

LXT501

Low luminance louver
Filtro antiabbagliamento
Filtre basse luminance
Geringe Leuchtdichte-Filter
Filtro de baja luminancia



Note: the filter must be ordered together with the lighting fixture - **Nota:** il filtro deve essere ordinato congiuntamente all'apparecchio - **Note:** le filtre doit être commandé en même temps que l'appareil - **Anmerkung:** muss der Filter zusammen mit Leuchtkörper bestellt werden
Nota: el filtro debe pedirse junto con la luminaria

Note: cable cut to measure on request
Nota: cavo a misura disponibile su richiesta
Note: câble sur mesure disponible sur demande
Anmerkung: kundenspezifisches Kabel auf Anfrage erhältlich
Nota: cable a medida disponible a petición

Drivers

Alimentatori - Alimentateurs
Netzteile - Alimentadores

24 VDC	on/off	dimming module	dimmable
	AL2012 (1..4) 60mm IP20	AL7035 IP20 PUSH DALI 0/1..10V	AL5012 (1..4) 45mm IP20 PUSH DALI 0/1..10V
	AL2031 (1..11) 70mm IP20		AL8012 (1..4) IP67 DALI
	AL2040 (1..25) 80mm IP20	Note: dimming module AL7035 to be used in combination with an on/off 24VDC power supply Nota: modulo di dimmerazione AL7035 da utilizzare in combinazione con un alimentatore on/off 24VDC Note: module de variation AL7035 d'intensité à utiliser en combinaison avec une alimentation on/off 24VDC Anmerkung: Dimmmodul AL7035 zur Verwendung in Kombination mit einem on/off 24VDC-Netzteil Nota: módulo de regulación AL7035 se utiliza en combinación con una fuente de alimentación on/off 24VDC	
	AL9212 (1..2) 110mm IP67		
	AL9231 (1..11) 85mm IP67		
	AL9240 (1..25) 85mm IP67		



DIG 6

design: Rod&Todd

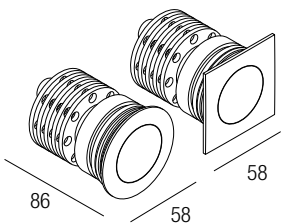

Supply current

Alimentazione
Courant d'alimentation
Stromversorgung
Corriente de alimentación

500 mA (V, 9V)

Power

Potenza
Puissance
Bestuekung
Potencia

6 W

Series wiring

Cablaggio in serie
Câblage en série
Verkabelung in Serie
Cableado en serie



Photometric diagrams

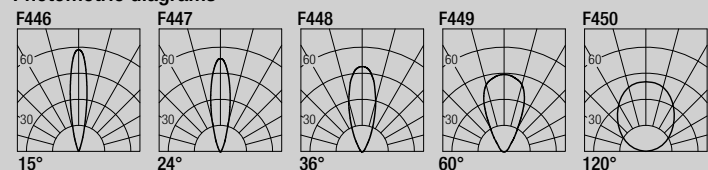

CCT/CRI/Flux

2700K — 540 lm
3000K — 600 lm
4000K — 620 lm

CRI98
2-Step MacAdam



Code Construction

Costruzione del codice - Construction du code produit
Bau der Produkt-Code - Construcción del código de producto

DIG6 X X X X

Beam angle	N	S	M	W	X
Apertura di fascio Angle de faisceau Strahlwinkel Ángulo del haz	15°	24°	36°	60°	120°
Finishing	G	N	K	Z	
Finitura Finitions Oberflächenfinish Acabados	Grey Grigio Gris Grau	Black Nero Noir Schwarz Negro	COR-TEN	INOX AISI 316L Steel Acciaio Acier Stahl Acero	
Color Temperature	2	3	4		
Temperatura colore Température couleur Temperaturabhängige Farbe Temperatura de color	2700K	3000K	4000K		
Shape	1	2			
Forma Forme Form	Round Tondo Ronde Runde Redondo	Square Quadro Carré Quadrat Cuadrado			

Accessories

Accessori - Accessoires
Zubehör - Accesorios

CSDS10

Recessing box
Controcassa
Boîtier d'encastrement
Eingießgehäuse
Caja de empotrar

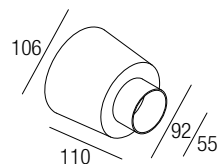

LDIG601

Low luminance louver
Filtro antiabbagliamento
Filtre basse luminance
Geringe Leuchtdichte-Filter
Filtro de baja luminancia

Note: the filter must be ordered together with the lighting fixture - **Nota:** il filtro deve essere ordinato congiuntamente all'apparecchio - **Note:** le filtre doit être commandé en même temps que l'appareil - **Anmerkung:** muss der Filter zusammen mit Leuchtkörper bestellt werden
Nota: el filtro debe pedirse junto con la luminaria

Note: cable cut to measure on request
Nota: cavo a misura disponibile su richiesta
Note: câble sur mesure disponible sur demande
Anmerkung: kundenspezifisches Kabel auf Anfrage erhältlich
Nota: cable a medida disponible a petición

Drivers

Alimentatori - Alimentateurs
Netzteile - Alimentadores

on/off	dimnable
500 mA	
AL1074 (1..2) 30mm IP20	AL4010 (1..4) 72mm IP20 PUSH 0/1..10V
AL1077 (1..2) 40mm IP20	AL4151 (1..4) 72mm IP20 DALI 2
AL1084 (1..3) 55mm IP20 S.P.	AL4153 (1..4) 56mm IP20 PUSH IGBT-TRIAC
AL9051 (1..3) 44mm IP67	AL8050 (2..4) IP67 DALI



DIG 10

design: Rod&Todd

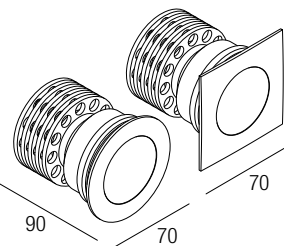

Supply current

Alimentazione
Courant d'alimentation
Stromversorgung
Corriente de alimentación

500 mA (V_i 18V)

Power

Potenza
Puissance
Bestuekung
Potencia

10 W

Series wiring

Cablaggio in serie
Câblage en série
Verkabelung in Serie
Cableado en serie



Photometric diagrams

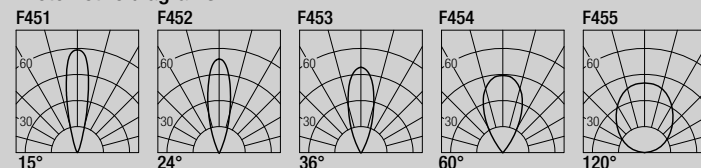

CCT/CRI/Flux

	CRI85	CRI93
2700K	890 lm	840 lm
3000K	1000 lm	930 lm
4000K	1040 lm	960 lm

CRI85 - CRI93
2-Step MacAdam



Code Construction

Costruzione del codice - Construction du code produit
Bau der Produkt-Code - Construcción del código de producto

DIG1 X X X X X

Beam angle N S M W X
Apertura di fascio 15° 24° 36° 60° 120°
Angle de faisceau
Strahlwinkel
Ángulo del haz

Finishing G N K Z
Finitura Grey Black COR-TEN INOX AISI
Finitions Gris Nero 316L
Oberflächenfinish Gris Noir 316L
Acabados Gris Schwarz Negro Steel Acaccia Acier Stahl Acero

CRI 8 9
85 93

Color Temperature 2 3 4
Temperatura colore 2700K 3000K 4000K
Température couleur
Temperaturabhängige Farbe
Temperatura de color

Shape 1 2
Forma Round Square
Forme Tondo Quadro
Forme Ronde Carré
Forme Runde Quadrat
Forme Redondo Cuadrado

Accessories

Accessori - Accessoires
Zubehör - Accesorios

CSXJ01

Recessing box
Controcassa
Boîtier d'encastrement
Eingießgehäuse
Caja de empotrar

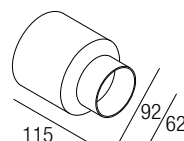

LDIG101

Low luminance louver
Filtro antiabbagliamento
Filtre basse luminance
Geringe Leuchtdichte-Filter
Filtro de baja luminancia

Note: the filter must be ordered together with the lighting fixture - **Nota:** il filtro deve essere ordinato congiuntamente all'apparecchio - **Note:** le filtre doit être commandé en même temps que l'appareil - **Anmerkung:** muss der Filter zusammen mit Leuchtkörper bestellt werden
Nota: el filtro debe pedirse junto con la luminaria

Note: cable cut to measure on request
Nota: cavo a misura disponibile su richiesta
Note: câble sur mesure disponible sur demande
Anmerkung: kundenspezifisches Kabel auf Anfrage erhältlich
Nota: cable a medida disponible a petición

Drivers

Alimentatori - Alimentateurs
Netzteile - Alimentadores

500 mA	on/off	dimming module
AL1074 (1)	AL4010 (1,2)	
30mm IP20	72mm IP20 PUSH 0/1..10V	
AL1077 (1)	AL4151 (1,2)	
40mm IP20	72mm IP20 DALI 2	
AL1084 (1,2)	AL4153 (1,2)	
55mm IP20 S.P.	56mm IP20 PUSH IGBT-TRIAC	
AL9051 (1,2)	AL8050 (1,2)	
44mm IP67	IP67 DALI	

DIG 724

design: Rod&Todd

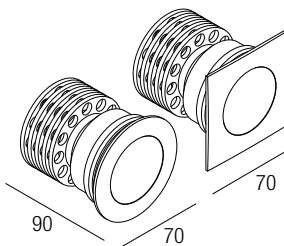

Supply current

Alimentazione
Courant d'alimentation
Stromversorgung
Corriente de alimentación

24 VDC

Power

Potenza
Puissance
Bestuekung
Potencia

7 W

Parallel wiring

Cablaggio in parallelo
Câblage en parallèle
Verkabelung in parallel
Cableado en paralelo



Photometric diagrams

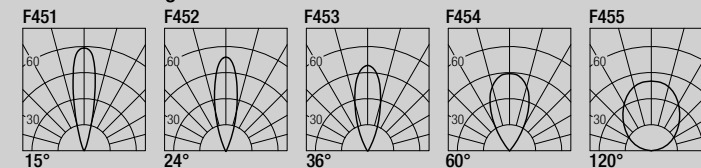

CCT/CRI/Flux

	CRI85	CRI93
2700K	630 lm	590 lm
3000K	700 lm	650 lm
4000K	730 lm	670 lm

CRI85 - CRI93
2-Step MacAdam

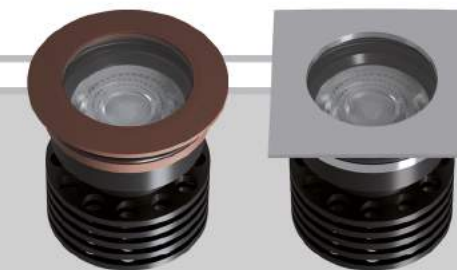

Code Construction

Costruzione del codice - Construction du code produit
Bau der Produkt-Code - Construcción del código de producto

DIG24 X X X X X

Beam angle N S M W X
Apertura di fascio 15° 24° 36° 60° 120°
Angle de faisceau
Strahlwinkel
Ángulo del haz

Finishing G N K Z
Finitura Grey Black COR-TEN INOX AISI
Finitions Gris Nero 316L
Oberflächenfinish Gris Noir 316L
Acabados Gris Schwarz Negro Steel Acaccia Acier Stahl Acero

CRI 8 9
85 93

Color Temperature 2 3 4
Temperatura colore 2700K 3000K 4000K
Température couleur
Temperaturabhängige Farbe
Temperatura de color

Shape 1 2
Forma Round Square
Forme Tondo Quadro
Forme Ronde Carré
Forme Runde Quadrat
Forme Redondo Cuadrado

Accessories

Accessori - Accessoires
Zubehör - Accesorios

CSXJ01

Recessing box
Controcassa
Boîtier d'encastrement
Eingießgehäuse
Caja de empotrar

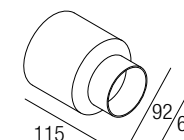

LDIG2401

Low luminance louver
Filtro antiabbagliamento
Filtre basse luminance
Geringe Leuchtdichte-Filter
Filtro de baja luminancia

Note: the filter must be ordered together with the lighting fixture - **Nota:** il filtro deve essere ordinato congiuntamente all'apparecchio - **Note:** le filtre doit être commandé en même temps que l'appareil - **Anmerkung:** muss der Filter zusammen mit Leuchtkörper bestellt werden
Nota: el filtro debe pedirse junto con la luminaria

Note: cable cut to measure on request
Nota: cavo a misura disponibile su richiesta
Note: câble sur mesure disponible sur demande
Anmerkung: kundenspezifisches Kabel auf Anfrage erhältlich
Nota: cable a medida disponible a petición

Drivers

Alimentatori - Alimentateurs
Netzteile - Alimentadores

24 VDC	on/off	dimming module	dimming module
AL2012 (1,3)	AL7035	AL5012 (1,3)	
60mm IP20	IP20 PUSH DALI 0/1..10V	45mm IP20 PUSH DALI 0/1..10V	
AL2031 (1,10)		AL8012 (1,3)	
70mm IP20		IP67 DALI	
AL2040 (1,21)			
80mm IP20			
AL9212 (1,2)			
110mm IP67			
AL9231 (1,10)			
85mm IP67			
AL9240 (1,21)			
85mm IP67			

Note: dimming module AL7035 to be used in combination with an on/off 24VDC power supply
Nota: modulo di dimmerazione AL7035 da utilizzare in combinazione con un alimentatore on/off 24VDC
Note: module de variation AL7035 d'intensité à utiliser en combinaison avec une alimentation on/off 24VDC
Anmerkung: Dimmmodul AL7035 zur Verwendung in Kombination mit einem on/off 24VDC-Netzteil
Nota: módulo de regulación AL7035 se utiliza en combinación con una fuente de alimentación on/off 24VDC

GLASS 2

design: Roberto Mantovani

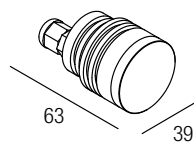

Supply current

Alimentazione
Courant d'alimentation
Stromversorgung
Corriente de alimentación
350-500 mA (V_i 2,9V)

Power

Potenza
Puissance
Bestuekung
Potencia
1-2 W

Series wiring

Cablaggio in serie
Câblage en série
Verkabelung in Serie
Cableado en serie



Photometric diagrams

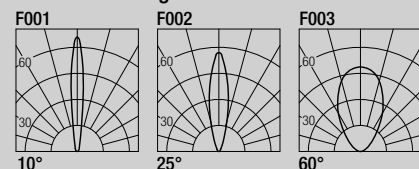

CCT/CRI/Flux

	350mA	500mA
2700K	89 lm	128 lm
3000K	93 lm	133 lm
4200K	103 lm	154 lm
6000K	114 lm	165 lm

CRI85

2-Step MacAdam

Code Construction

Costruzione del codice - Construction du code produit
Bau der Produkt-Code - Construcción del código de producto

GS2 X X

Color Temperature	0	1	2	3	6	7	8
Temperatura colore	2700K	3000K	4200K	6000K	Blue	Green	Red
Température couleur					Bleu	Vert	Rouge
Temperaturabhängige Farbe					Blau	Grün	Rot
Temperatura de color					Azul		Rojo

Beam angle	0	1	2
Apertura di fascio	10°	25°	60°
Angle de faisceau			
Strahlwinkel			
Ángulo del haz			

Accessories

Accessori - Accessoires
Zubehör - Accesorios

CSGS01

Recessing box with trim
Controcassa con bordo
Boîtier d'encastrement avec bord
Eingieβgehäuse mit Rand
Caja de empotrar con borde

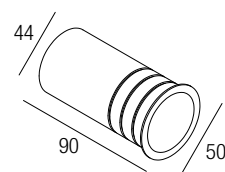

Note: recessing box needed for installation
Nota: installazione con controcassa obbligatoria
Note: boîtier d'encastrement obligatoire
Anmerkung: Installation mit Einbaugehäuse verpflichtend
Nota: caja de empotrar necesaria para la instalación

LGS201

Low luminance louver
Filtro antiabbagliamento
Filtre basse luminance
Geringe Leuchtdichte-Filter
Filtro de baja luminancia



Note: the filter must be ordered together with the lighting fixture - **Nota:** il filtro deve essere ordinato congiuntamente all'apparecchio - **Note:** le filtre doit être commandé en même temps que l'appareil - **Anmerkung:** muss der Filter zusammen mit Leuchtkörper bestellt werden
Nota: el filtro debe pedirse junto con la luminaria

Note: cable cut to measure on request
Nota: cavo a misura disponibile su richiesta
Note: câble sur mesure disponible sur demande
Anmerkung: kundenspezifisches Kabel auf Anfrage erhältlich
Nota: cable a medida disponible a petición

Drivers

Alimentatori - Alimentateurs
Netzteile - Alimentadores

350 mA		500 mA	
on/off	dimmmable	on/off	dimmmable
AL1034 (1.11) 30mm IP20	AL4000 (1.12) 72mm IP20 PUSH 0/1..10V	AL1074 (1.7) 30mm IP20	AL4010 (1.12) 72mm IP20 PUSH 0/1..10V
AL1035 (1.11) 40mm IP20	AL4051 (2.14) 72mm IP20 DALI 2	AL1077 (1.6) 40mm IP20	AL4151 (2.14) 72mm IP20 DALI 2
AL1037 (1.16) 55mm IP20 S.P.	AL4053 (1.14) 56mm IP20 PUSH IGBT-TRIAC	AL1084 (1.11) 55mm IP20 S.P.	AL4153 (1.14) 56mm IP20 PUSH IGBT-TRIAC
AL9011 (1.12) 44mm IP67	AL8035 (4.16) IP67 DALI	AL9051 (1.11) 44mm IP67	AL8050 (4.16) IP67 DALI



GLASS 6

design: Roberto Mantovani

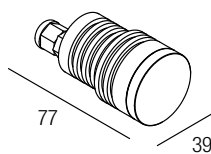

Supply current

Alimentazione
 Courant d'alimentation
 Stromversorgung
 Corriente de alimentación
350-500 mA (V, 8,7V)

Power

Potenza
 Pouissance
 Bestuekung
 Potencia
3-6 W

Series wiring

Cablaggio in serie
 Câblage en série
 Verkabelung in Serie
 Cableado en serie



Photometric diagrams

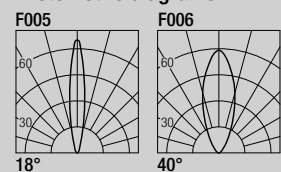

CCT/CRI/Flux

	350mA	500mA
2700K	267 lm	384 lm
3000K	279 lm	400 lm
4200K	309 lm	462 lm
6000K	342 lm	495 lm

CRI85

2-Step MacAdam

Code Construction

Costruzione del codice - Construction du code produit
 Bau der Produkt-Code - Construcción del código de producto

GS6 X X

Color Temperature	0	1	2	3	6	7	8
Temperatura colore	2700K	3000K	4200K	6000K	Blue	Green	Red
Température couleur					Bleu	Vert	Rouge
Temperaturabhängige Farbe					Blau	Grün	Rot
Temperatura de color					Azul	Rojo	

Beam angle	0	1
Apertura di fascio	18°	40°
Angle de faisceau		
Strahlwinkel		
Ángulo del haz		

Accessories

Accessori - Accessoires
 Zubehör - Accesorios

CSGS01

Recessing box with trim
 Controcassa con bordo
 Boîtier d'encastrement avec bord
 Eingießgehäuse mit Rand
 Caja de empotrar con borde

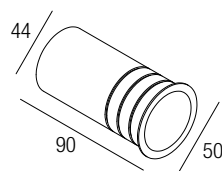

Note: recessing box needed for installation
Nota: installazione con controcassa obbligatoria
Note: boîtier d'encastrement obligatoire
Anmerkung: Installation mit Einbauegehäuse verpflichtend
Nota: caja de empotrar necesaria para la instalación

LGS601

Low luminance louver
 Filtro antiabbagliamento
 Filtre basse luminance
 Geringe Leuchtdichte-Filter
 Filtro de baja luminancia

Note: the filter must be ordered together with the lighting fixture - **Nota:** il filtro deve essere ordinato congiuntamente all'apparecchio - **Note:** le filtre doit être commandé en même temps que l'appareil - **Anmerkung:** muss der Filter zusammen mit Leuchtkörper bestellt werden
Nota: el filtro debe pedirse junto con la luminaria

Note: cable cut to measure on request
Nota: cavo a misura disponibile su richiesta
Note: câble sur mesure disponible sur demande
Anmerkung: kundenspezifisches Kabel auf Anfrage erhältlich
Nota: cable a medida disponible a petición

Drivers

Alimentatori - Alimentateurs
 Netzteile - Alimentadores

350 mA		500 mA	
on/off	dimmable	on/off	dimmable
AL1034 (1..3) 30mm IP20	AL4000 (1..4) 72mm IP20 PUSH 0/1..10V	AL1074 (1..2) 30mm IP20	AL4010 (1..4) 72mm IP20 PUSH 0/1..10V
AL1035 (1..3) 40mm IP20	AL4051 (1..4) 72mm IP20 DALI 2	AL1077 (1..2) 40mm IP20	AL4151 (1..4) 72mm IP20 DALI 2
AL1037 (1..5) 55mm IP20 S.P.	AL4053 (1..4) 56mm IP20 PUSH IGBT-TRIAC	AL1084 (1..3) 55mm IP20 S.P.	AL4153 (1..4) 56mm IP20 PUSH IGBT-TRIAC
AL9011 (1..4) 44mm IP67	AL8035 (2..4) IP67 DALI	AL9051 (1..3) 44mm IP67	AL8050 (2..4) IP67 DALI



GLASS 524

design: Roberto Mantovani

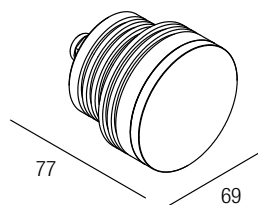

Supply current

Alimentazione
Courant d'alimentation
Stromversorgung
Corriente de alimentación

24 VDC

Power

Potenza
Puissance
Bestuekung
Potencia

6 W

Parallel wiring

Cablaggio in parallelo
Câblage en parallèle
Verkabelung in parallel
Cableado en paralelo



CCT/CRI/Flux

2700K — 384 lm
3000K — 400 lm
4200K — 462 lm
6000K — 495 lm

CRI85
2-Step MacAdam

Photometric diagrams

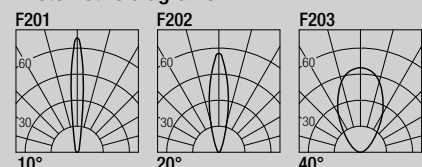

Code Construction

Costruzione del codice - Construction du code produit
Bau der Produkt-Code - Construcción del código de producto

GS5 X X

Color Temperature

	0	1	2	3	6	7	8
Temperatura colore	2700K	3000K	4200K	6000K	Blue	Green	Red
Température couleur					Bleu	Vert	Rouge
Temperaturabhängige Farbe					Blau	Grün	Rot
Temperatura de color					Azul		Rojo

Beam angle

	0	1	2
Apertura di fascio	10°	20°	40°
Angle de faisceau			
Strahlwinkel			
Ángulo del haz			

Drivers

Alimentatori - Alimentateurs
Netzteile - Alimentadores

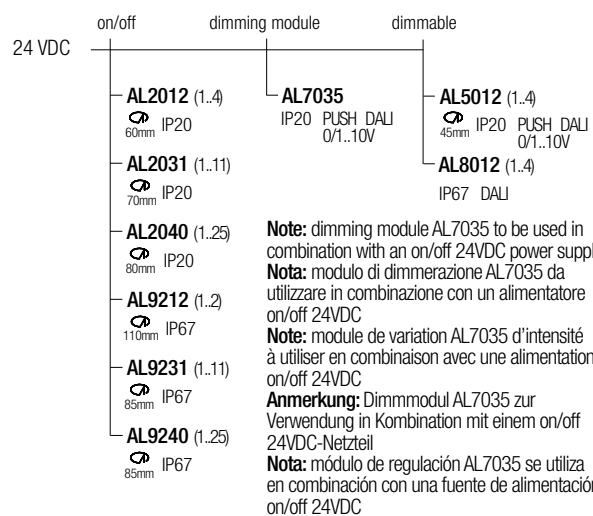

- DATASHEET ▶
- INSTALLATION MANUAL ▶
- CERTIFICATIONS ▶
- LDT-IES ▶
- DRAWINGS ▶

Accessories

Accessori - Accessoires
Zubehör - Accesorios

CSGS05

Recessing box with trim
Controcassa con bordo
Boîtier d'encastrement avec bord
Eingießgehäuse mit Rand
Caja de empotrar con borde

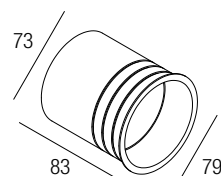

Note: recessing box needed for installation
Nota: installazione con controcassa obbligatoria
Note: boîtier d'encastrement obligatoire
Anmerkung: Installation mit Einbaugeschäule verpflichtend
Nota: caja de empotrar necesaria para la instalación

LGS501

Low luminance louver
Filtro antiabbagliamento
Filtre basse luminance
Geringe Leuchtdichte-Filter
Filtro de baja luminancia



Note: the filter must be ordered together with the lighting fixture - **Nota:** il filtro deve essere ordinato congiuntamente all'apparecchio - **Note:** le filtre doit être commandé en même temps que l'appareil - **Anmerkung:** muss der Filter zusammen mit Leuchtkörper bestellt werden
Nota: el filtro debe pedirse junto con la luminaria

Note: cable cut to measure on request
Nota: cavo a misura disponibile su richiesta
Note: câble sur mesure disponible sur demande
Anmerkung: kundenspezifisches Kabel auf Anfrage erhältlich
Nota: cable a medida disponible a petición



GLASS 724

design: Roberto Mantovani

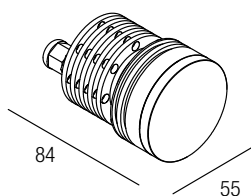

Supply current

Alimentazione
Courant d'alimentation
Stromversorgung
Corriente de alimentación

24 VDC

Power

Potenza
Puissance
Bestuekung
Potencia

7 W

Parallel wiring

Cablaggio in parallelo
Câblage en parallèle
Verkabelung in parallel
Cableado en paralelo



Photometric diagrams

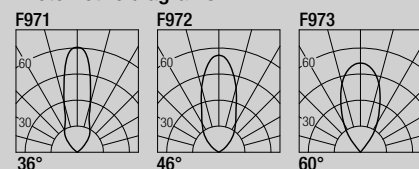

CCT/CRI/Flux

	CRI85	CRI93
2700K	630 lm	590 lm
3000K	700 lm	650 lm
4000K	730 lm	670 lm

CRI85 - CRI93

2-Step MacAdam

Code Construction

Costruzione del codice - Construction du code produit
Bau der Produkt-Code - Construcción del código de producto

GS7 X X X

Beam angle	S	M	W
Apertura di fascio Angle de faisceau Strahlwinkel Ángulo del haz	36°	46°	60°

CRI	8	9
	85	93

Color Temperature	2	3	4
Temperatura colore Température couleur Temperaturabhängige Farbe Temperatura de color	2700K	3000K	4000K

Drivers

Alimentatori - Alimentateurs
Netzteile - Alimentadores

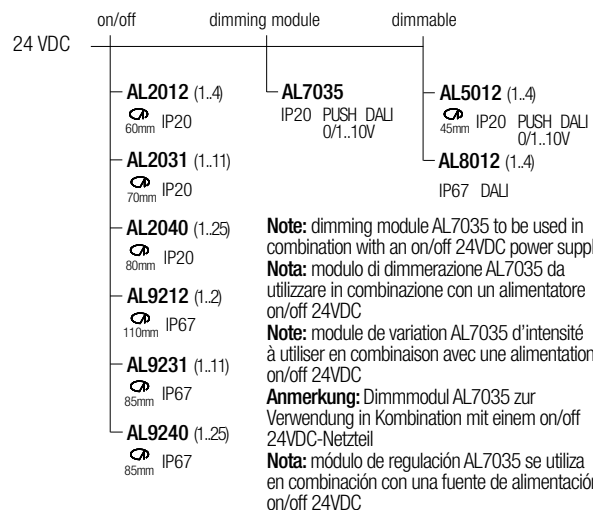

Accessories

Accessori - Accessoires
Zubehör - Accesorios

CSGS07

Recessing box with trim
Controcassa con bordo
Boîtier d'encastrement avec bord
Eingießgehäuse mit Rand
Caja de empotrar con borde

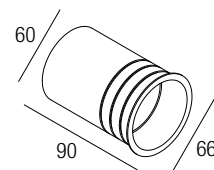

Note: recessing box needed for installation
Nota: installazione con controcassa obbligatoria
Note: boîtier d'encastrement obligatoire
Anmerkung: Installation mit Einbauegehäuse verpflichtend
Nota: caja de empotrar necesaria para la instalación

LGS701

Low luminance louver
Filtro antiabbagliamento
Filtre basse luminance
Geringe Leuchtdichte-Filter
Filtro de baja luminancia



Note: the filter must be ordered together with the lighting fixture - **Nota:** il filtro deve essere ordinato congiuntamente all'apparecchio - **Note:** le filtre doit être commandé en même temps que l'appareil - **Anmerkung:** muss der Filter zusammen mit Leuchtkörper bestellt werden
Nota: el filtro debe pedirse junto con la luminaria

Note: cable cut to measure on request
Nota: cavo a misura disponibile su richiesta
Note: câble sur mesure disponible sur demande
Anmerkung: kundenspezifisches Kabel auf Anfrage erhältlich
Nota: cable a medida disponible a petición



JAN 2

design: Roberto Mantovani

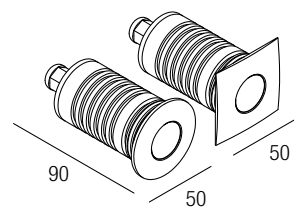

Supply current
 Alimentazione
 Courant d'alimentation
 Stromversorgung
 Corriente de alimentación
350-500 mA (V, 2,9V)

Power
 Potenza
 Pouissance
 Bestuekung
 Potencia
1-2 W

Series wiring
 Cablaggio in serie
 Câblage en série
 Verkabelung in Serie
 Cableado en serie

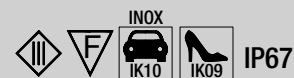

Photometric diagrams

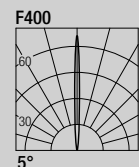

CCT/CRI/Flux	350mA		500mA	
	2700K	3000K	4200K	6000K
	89 lm	93 lm	128 lm	133 lm
	103 lm	114 lm	154 lm	165 lm

CRI85
2-Step MacAdam

Code Construction

Costruzione del codice - Construction du code produit
 Bau der Produkt-Code - Construcción del código de producto

JN1 X X X 5

Beam angle 5°
 Apertura di fascio 5°
 Angle de faisceau 5°
 Strahlwinkel 5°
 Ángulo del haz 5°

Color Temperature	0	1	2	3	6	7	8
Temperatura colore	2700K	3000K	4200K	6000K	Blue	Green	Red
Température couleur					Bleu	Vert	Rouge
Temperaturabhängige Farbe					Blau	Grün	Rot
Temperatura de color					Azul	Rojo	

Finishing	G	N	K	Z
Finitura	Grey	Black	COR-TEN	INOX AISI 316L
Finitions	Grigio	Nero		Acciaio
Oberflächenfinish	Gris	Noir		Acier
Acabados	Grau	Schwarz		Stahl
		Negro		Acero

Shape	1	2
Forma	Round	Square
Forme	Tondo	Quadro
Form	Ronde	Carrè
	Runde	Quadrat
	Redondo	Cuadrado

Accessories

Accessori - Accessoires
 Zubehör - Accesorios

CSBU01

Recessing box
 Controcassa
 Boîtier d'encastrement
 Eingieβgehäuse
 Caja de empotrar

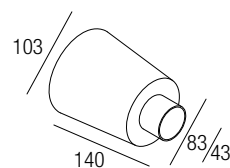

Note: cable cut to measure on request
Nota: cavo a misura disponibile su richiesta
Note: câble sur mesure disponible sur demande
Anmerkung: kundenspezifisches Kabel auf Anfrage erhältlich
Nota: cable a medida disponible a petición

Drivers

Alimentatori - Alimentateurs
 Netzteile - Alimentadores

350 mA	on/off	dimmmable
AL1034 (1.11)	AL4000 (1.12)	
30mm IP20	72mm IP20 PUSH 0/1..10V	
AL1035 (1.11)	AL4051 (2.14)	
40mm IP20	72mm IP20 DALI 2	
AL1037 (1.16)	AL4053 (1.14)	
55mm IP20 S.P.	56mm IP20 PUSH IGBT-TRIAC	
AL9011 (1.12)	AL8035 (4.16)	
44mm IP67	IP67 DALI	
500 mA	on/off	dimmmable
AL1074 (1.7)	AL4010 (1.12)	
30mm IP20	72mm IP20 PUSH 0/1..10V	
AL1077 (1.6)	AL4151 (2.14)	
40mm IP20	72mm IP20 DALI 2	
AL1084 (1.11)	AL4153 (1.14)	
55mm IP20 S.P.	56mm IP20 PUSH IGBT-TRIAC	
AL9051 (1.11)	AL8050 (4.16)	
44mm IP67	IP67 DALI	

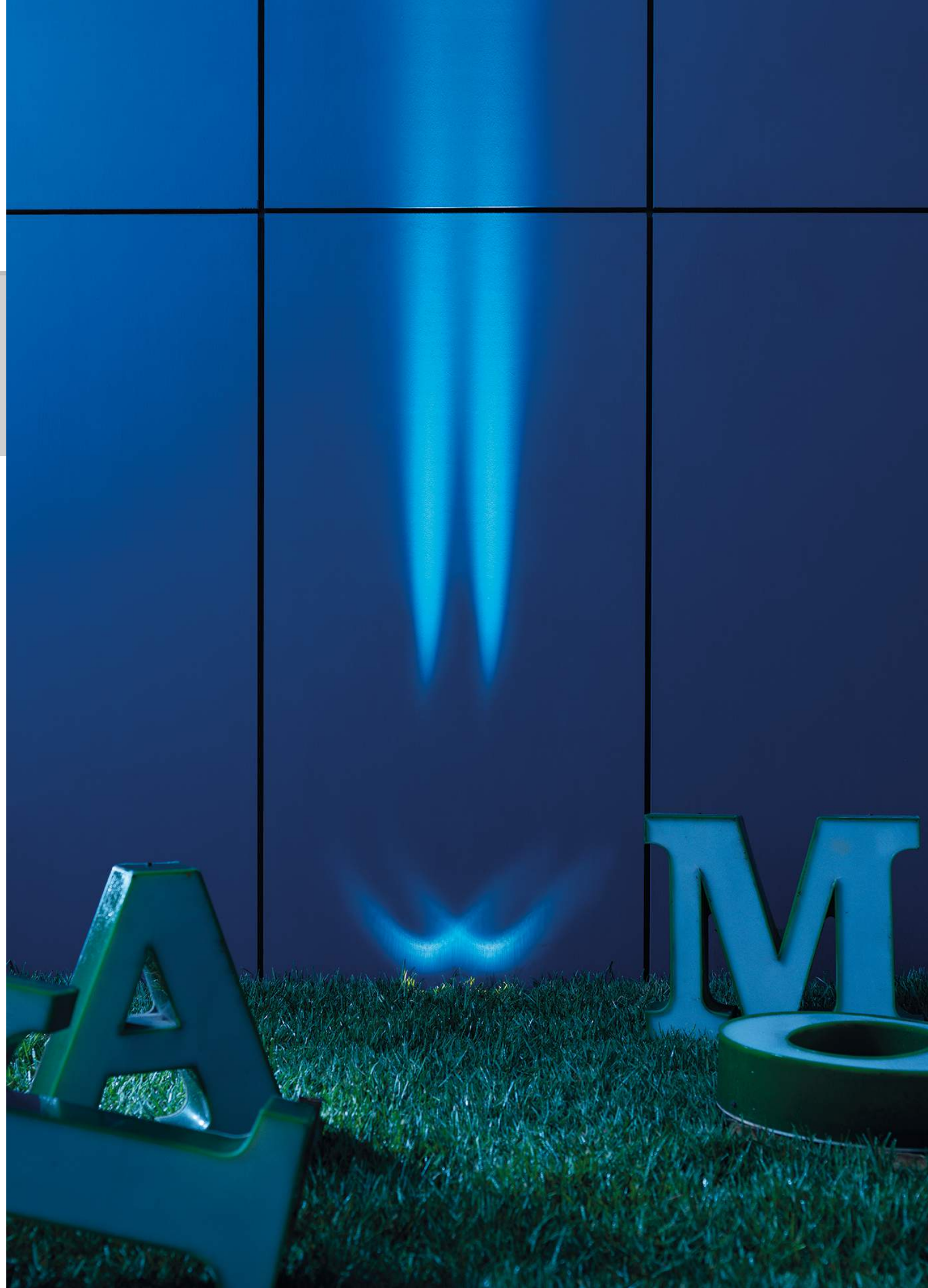

JAN 10

design: Roberto Mantovani

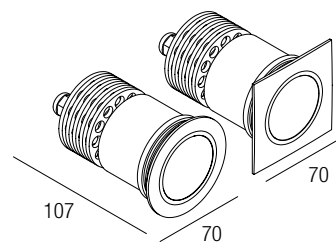

Supply current
 Alimentazione
 Courant d'alimentation
 Stromversorgung
 Corriente de alimentación
250 mA (V, 36V)

Power
 Potenza
 Puissance
 Bestuekung
 Potencia
10 W

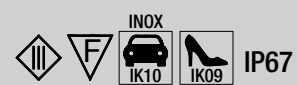

Photometric diagrams

F001

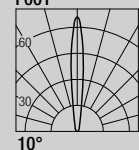

CCT/CRI/Flux	CRI85	CRI93
2700K	890 lm	840 lm
3000K	1000 lm	930 lm
4000K	1040 lm	960 lm

CRI85 - CRI93
2-Step MacAdam



Code Construction

Costruzione del codice - Construction du code produit
 Bau der Produkt-Code - Construcción del código de producto

JN2 X X X X 1

Beam angle 10°
 Apertura di fascio 10°
 Angle de faisceau 10°
 Strahlwinkel 10°
 Ángulo del haz 10°

CRI **8** **9**
 85 93

Color Temperature **2** **3** **4**
 Temperatura colore 2700K 3000K 4000K
 Température couleur
 Temperaturabhängige Farbe
 Temperatura de color

Finishing **G** **N** **K** **Z**
 Finitura Grey Black COR-TEN INOX AISI 316L
 Finitions Grigio Nero Steel
 Oberflächenfinish Gris Noir Acciaio
 Acabados Grau Schwarz Acier
 Negro Stahl
 Acero

Shape **1** **2**
 Forma Round Square
 Forme Tondo Quadro
 Form Ronde Carré
 Runde Quadrat
 Redondo Cuadrado

Accessories

Accessori - Accessoires
 Zubehör - Accesorios

CSXJ01

Recessing box
 Controcassa
 Boîtier d'encastrement
 Eingieβgehäuse
 Caja de empotrar

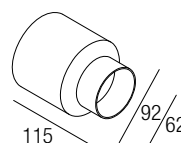

Note: cable cut to measure on request
Nota: cavo a misura disponibile su richiesta
Note: câble sur mesure disponible sur demande
Anmerkung: kundenspezifisches Kabel auf Anfrage erhältlich
Nota: cable a medida disponible a petición

Drivers

Alimentatori - Alimentateurs
 Netzteile - Alimentadores

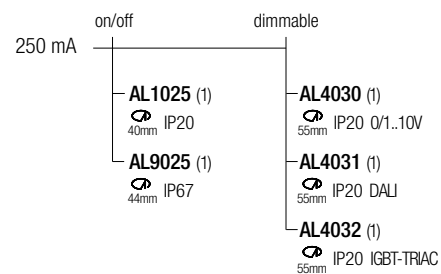

BREE

design: Roberto Mantovani

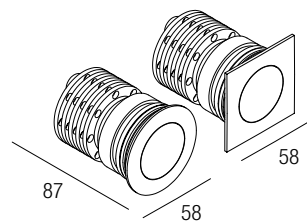

Supply current

Alimentazione
Courant d'alimentation
Stromversorgung
Corriente de alimentación
24 VDC

Power

Potenza
Puissance
Bestuekung
Potencia
7 W

Parallel wiring

Cablaggio in parallelo
Câblage en parallèle
Verkabelung in parallel
Cableado en paralelo

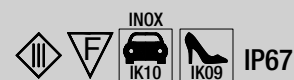

Photometric diagrams

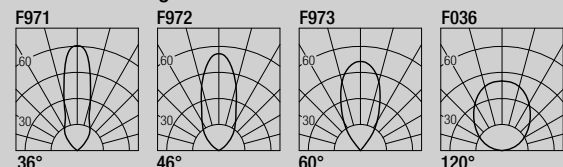

CCT/CRI/Flux

	CRI85	CRI93
2700K	630 lm	590 lm
3000K	700 lm	650 lm
4000K	730 lm	670 lm

CRI85 - CRI93
2-Step MacAdam



Code Construction

Costruzione del codice - Construction du code produit
Bau der Produkt-Code - Construcción del código de producto

BR1 X X X X X

Beam angle	S	M	W	X
Apertura di fascio Angle de faisceau Strahlwinkel Ángulo del haz	36°	46°	60°	120°

Finishing	G	N	K	Z
Finitura Finitions Oberflächenfinish Acabados	Grey Grigio Gris Gau	Black Nero Noir Schwarz Negro	COR-TEN	INOX AISI 316L Steel Acciaio Acier Stahl Acero

CRI	8	9
	85	93

Color Temperature	2	3	4
Temperatura colore Température couleur Temperaturabhängige Farbe Temperatura de color	2700K	3000K	4000K

Shape	1	2
Forma Forme Form	Round Tondo Ronde Runde Redondo	Square Quadro Carré Quadrat Cuadrado

Accessories

Accessori - Accessoires
Zubehör - Accesorios

CSDS10

Recessing box
Controcassa
Boîtier d'encastrement
Eingießgehäuse
Caja de empotrar

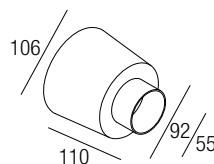

LBR101

Low luminance louver
Filtro antiabbagliamento
Filtre basse luminance
Geringe Leuchtdichte-Filter
Filtro de baja luminancia

Note: the filter must be ordered together with the lighting fixture - **Nota:** il filtro deve essere ordinato congiuntamente all'apparecchio - **Note:** le filtre doit être commandé en même temps que l'appareil - **Anmerkung:** muss der Filter zusammen mit Leuchtkörper bestellt werden
Nota: el filtro debe pedirse junto con la luminaria

Note: cable cut to measure on request
Nota: cavo a misura disponibile su richiesta
Note: câble sur mesure disponible sur demande
Anmerkung: kundenspezifisches Kabel auf Anfrage erhältlich
Nota: cable a medida disponible a petición

Drivers

Alimentatori - Alimentateurs
Netzteile - Alimentadores

24 VDC	on/off	dimming module	dimmable
AL2012 (1.4)	AL7035	AL5012 (1.4)	
60mm IP20	IP20 PUSH DALI 0/1..10V	45mm IP20 PUSH DALI 0/1..10V	
AL2031 (1.11)		AL8012 (1.4)	
70mm IP20		IP67 DALI	
AL2040 (1.25)			
80mm IP20			
AL9212 (1.2)			
110mm IP67			
AL9231 (1.11)			
85mm IP67			
AL9240 (1.25)			
85mm IP67			

Note: dimming module AL7035 to be used in combination with an on/off 24VDC power supply
Nota: modulo di dimmerazione AL7035 da utilizzare in combinazione con un alimentatore on/off 24VDC
Note: module de variation AL7035 d'intensité à utiliser en combinaison avec une alimentation on/off 24VDC
Anmerkung: Dimmmodul AL7035 zur Verwendung in Kombination mit einem on/off 24VDC-Netzteil
Nota: módulo de regulación AL7035 se utiliza en combinación con una fuente de alimentación on/off 24VDC



DESERT 5

design: Lapo Grassellini

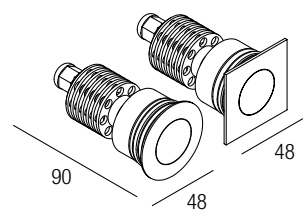

Supply current
 Alimentazione
 Courant d'alimentation
 Stromversorgung
 Corriente de alimentación
140 mA (V, 36V)

Power
 Potenza
 Pouissance
 Bestuekung
 Potencia
5 W

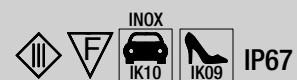

Photometric diagrams

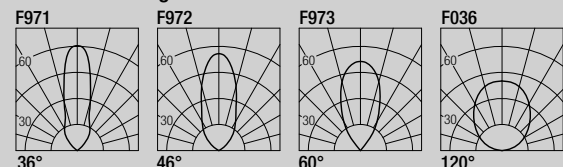

CCT/CRI/Flux	CRI85	CRI93
2700K	450 lm	425 lm
3000K	510 lm	470 lm
4000K	530 lm	490 lm

CRI85 - CRI93
2-Step MacAdam



Code Construction

Costruzione del codice - Construction du code produit
 Bau der Produkt-Code - Construcción del código de producto

DS5 X X X X X

Beam angle — S M W X
 Apertura di fascio 36° 46° 60° 120°
 Angle de faisceau
 Strahlwinkel
 Ángulo del haz

Finishing — G N K Z
 Finitura Grey Black COR-TEN INOX AISI 316L
 Finitions Grigio Nero Steel
 Oberflächenfinish Gris Noir Acciaio
 Acabados Grau Schwarz Stahl
 Acero

CRI — 8 9
 85 93

Color Temperature — 2 3 4
 Temperatura colore 2700K 3000K 4000K
 Température couleur
 Temperaturabhängige Farbe
 Temperatura de color

Shape — 1 2
 Forma Round Square
 Forme Tondo Quadro
 Forme Ronde Carré
 Runde Quadrat
 Redondo Cuadrado

Accessories

Accessori - Accessoires
 Zubehör - Accesorios

CSDS05

Recessing box
 Controcassa
 Boîtier d'encastrement
 Eingießgehäuse
 Caja de empotrar

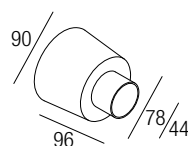

LDS501

Low luminance louver
 Filtro antiabbagliamento
 Filtre basse luminance
 Geringe Leuchtdichte-Filter
 Filtro de baja luminancia

Note: the filter must be ordered together with the lighting fixture - **Nota:** il filtro deve essere ordinato congiuntamente all'apparecchio - **Note:** le filtre doit être commandé en même temps que l'appareil - **Anmerkung:** muss der Filter zusammen mit Leuchtkörper bestellt werden
Nota: el filtro debe pedirse junto con la luminaria

Note: cable cut to measure on request
Nota: cavo a misura disponibile su richiesta
Note: câble sur mesure disponible sur demande
Anmerkung: kundenspezifisches Kabel auf Anfrage erhältlich
Nota: cable a medida disponible a petición

Drivers

Alimentatori - Alimentateurs
 Netzteile - Alimentadores

140 mA on/off
AL9014 (1)
 44mm IP67



DESERT 10

design: Lapo Grassellini

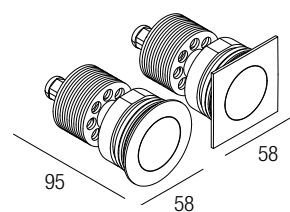

Supply current
 Alimentazione
 Courant d'alimentation
 Stromversorgung
 Corriente de alimentación
250 mA (V, 36V)

Power
 Potenza
 Puissance
 Bestuekung
 Potencia
10 W

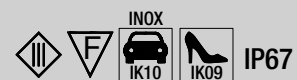

Photometric diagrams

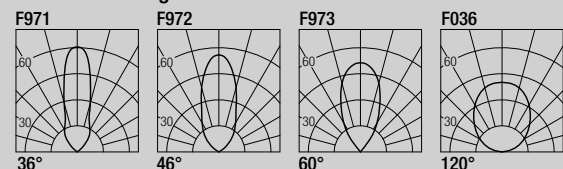

CCT/CRI/Flux	CRI85	CRI93
2700K	890 lm	840 lm
3000K	1000 lm	930 lm
4000K	1040 lm	960 lm

CRI85 - CRI93
2-Step MacAdam



Code Construction

Costruzione del codice - Construction du code produit
 Bau der Produkt-Code - Construcción del código de producto

DS1 X X X X X

Beam angle

S	M	W	X
36°	46°	60°	120°

Apertura di fascio
 Angle de faisceau
 Strahlwinkel
 Ángulo del haz

Finishing

G	N	K	Z
Grey	Black	COR-TEN	INOX AISI 316L
Grigio	Nero		Steel
Gris	Noir		Acciaio
Grau	Schwarz		Acier
	Negro		Stahl
			Acero

Finitura
 Finitions
 Oberflächenfinish
 Acabados

CRI

8	9
85	93

Color Temperature

2	3	4
2700K	3000K	4000K

Temperatura colore
 Temperature couleur
 Temperaturabhängige Farbe
 Temperatura de color

Shape

1	2
Round	Square
Tondo	Quadro
Ronde	Carré
Runde	Quadrat
Redondo	Cuadrado

Forma
 Forme
 Form

Accessories

Accessori - Accessoires
 Zubehör - Accesorios

CSDS10

Recessing box
 Controcassa
 Boîtier d'encastrement
 Eingießgehäuse
 Caja de empotrar

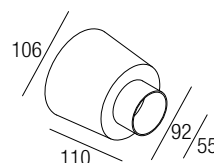

LDS101

Low luminance louver
 Filtro antiabbagliamento
 Filtre basse luminance
 Geringe Leuchtdichte-Filter
 Filtro de baja luminancia



Note: the filter must be ordered together with the lighting fixture - **Nota:** il filtro deve essere ordinato congiuntamente all'apparecchio - **Note:** le filtre doit être commandé en même temps que l'appareil - **Anmerkung:** muss der Filter zusammen mit Leuchtkörper bestellt werden
Nota: el filtro debe pedirse junto con la luminaria

Note: cable cut to measure on request
Nota: cavo a misura disponibile su richiesta
Note: câble sur mesure disponible sur demande
Anmerkung: kundenspezifisches Kabel auf Anfrage erhältlich
Nota: cable a medida disponible a petición

Drivers

Alimentatori - Alimentateurs
 Netzteile - Alimentadores

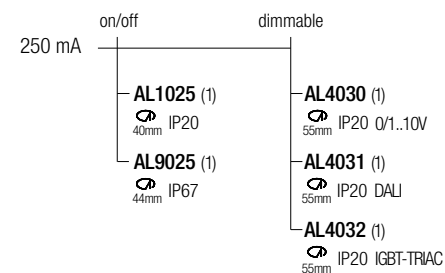

DESERT 20

design: Lapo Grassellini

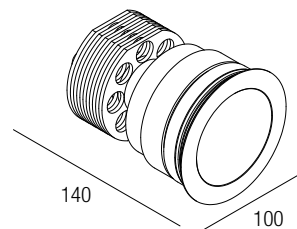

Supply current
 Alimentazione
 Courant d'alimentation
 Stromversorgung
 Corriente de alimentación
500 mA (V, 36V)

Power
 Potenza
 Pouissance
 Bestuekung
 Potencia
20 W

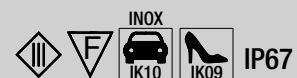

Photometric diagrams

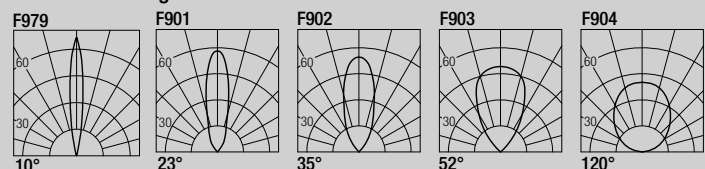

CCT/CRI/Flux

	CRI85	CRI93
2700K	1830 lm	1700 lm
3000K	2000 lm	1830 lm
4000K	2100 lm	1950 lm

CRI85 - CRI93
 2-Step MacAdam



Code Construction

Costruzione del codice - Construction du code produit
 Bau der Produkt-Code - Construcción del código de producto

DS21 X X X X

Beam angle	XS	S	M	W	X
Apertura di fascio Angle de faisceau Strahlwinkel Ángulo del haz	10°	23°	35°	52°	120°
Finishing	G	N	K	Z	
Finitura Finitions Oberflächenfinish Acabados	Grey Grigio Gris Grau	Black Nero Noir Schwarz Negro	COR-TEN	INOX AISI 316L Steel Acciaio Acier Stahl Acero	
CRI	8	9			
	85	93			
Color Temperature	2	3	4		
Temperatura colore Température couleur Temperaturabhängige Farbe Temperatura de color	2700K	3000K	4000K		

Accessories

Accessori - Accessoires
 Zubehör - Accesorios

CSDS20

Recessing box
 Controcassa
 Boîtier d'encastrement
 Eingieβgehäuse
 Caja de empotrar

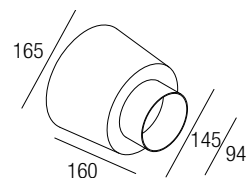

LDS2101

Low luminance louver
 Filtro antiabbagliamento
 Filtre basse luminance
 Geringe Leuchtdichte-Filter
 Filtro de baja luminancia



Note: the filter must be ordered together with the lighting fixture - **Nota:** il filtro deve essere ordinato congiuntamente all'apparecchio - **Note:** le filtre doit être commandé en même temps que l'appareil - **Anmerkung:** muss der Filter zusammen mit Leuchtkörper bestellt werden
Nota: el filtro debe pedirse junto con la luminaria

Note: cable cut to measure on request
Nota: cavo a misura disponibile su richiesta
Note: câble sur mesure disponible sur demande
Anmerkung: kundenspezifisches Kabel auf Anfrage erhältlich
Nota: cable a medida disponible a petición

Drivers

Alimentatori - Alimentateurs
 Netzteile - Alimentadores

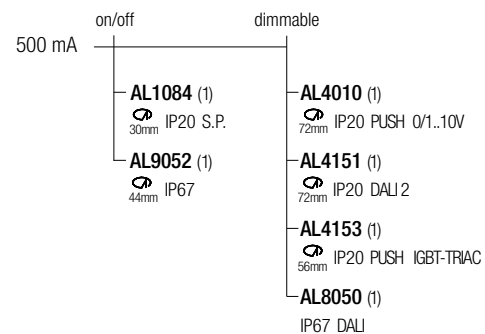

JENA 2

design: Roberto Mantovani

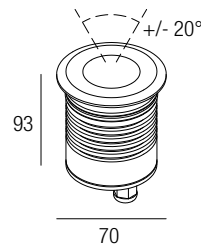

Supply current

Alimentazione
Courant d'alimentation
Stromversorgung
Corriente de alimentación
350-500 mA (V_I 2,9V)

Power

Potenza
Pouissance
Bestuekung
Potencia
1-2 W

Series wiring

Cablaggio in serie
Câblage en série
Verkabelung in Serie
Cableado en serie

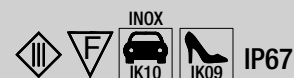

Photometric diagrams

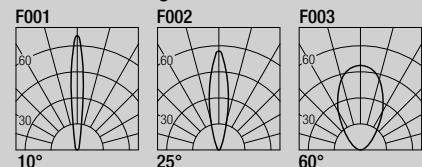

CCT/CRI/Flux

	350mA	500mA
2700K	89 lm	128 lm
3000K	93 lm	133 lm
4200K	103 lm	154 lm
6000K	114 lm	165 lm

CRI85

2-Step MacAdam

Code Construction

Costruzione del codice - Construction du code produit
Bau der Produkt-Code - Construcción del código de producto

XJ11 X X X

Finishing

	G	N	K	Z
Finitura Finitions Oberflächenfinish Acabados	Grey Grigio Gris Grau	Black Nero Noir Schwarz Negro	COR-TEN	INOX AISI 316L Steel Acciaio Acier Stahl Acero

Color Temperature

	0	1	2	3	6	7	8
Temperatura colore Température couleur Temperaturabhängige Farbe Temperatura de color	2700K	3000K	4200K	6000K	Blue Blu Bleu Blau Azul	Green Verde Vert Grün	Red Rosso Rouge Rot Rojo

Beam angle

	0	1	2
Apertura di fascio Angle de faisceau Strahlwinkel Angulo del haz	10°	25°	60°

Accessories

Accessori - Accessoires
Zubehör - Accesorios

CSXJ01

Recessing box
Controcassa
Boîtier d'encastrement
Eingießgehäuse
Caja de empotrar

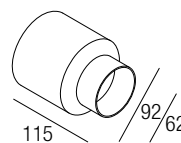

Note: cable cut to measure on request
Nota: cavo a misura disponibile su richiesta
Note: câble sur mesure disponible sur demande
Anmerkung: kundenspezifisches Kabel auf Anfrage erhältlich
Nota: cable a medida disponible a petición

Drivers

Alimentatori - Alimentateurs
Netzteile - Alimentadores

350 mA	on/off	dimmable
AL1034 (1.11)	30mm IP20	AL4000 (1.12)
AL1035 (1.11)	40mm IP20	AL4051 (2.14)
AL1037 (1.16)	55mm IP20 S.P.	AL4053 (1.14)
AL9011 (1.12)	44mm IP67	AL8035 (4.16)
		IP67 DALI
500 mA	on/off	dimmable
AL1074 (1.7)	30mm IP20	AL4010 (1.12)
AL1077 (1.6)	40mm IP20	AL4151 (2.14)
AL1084 (1.11)	55mm IP20 S.P.	AL4153 (1.14)
AL9051 (1.11)	44mm IP67	AL8050 (4.16)
		IP67 DALI

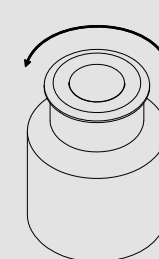

1
Unscrew the front ring

Svitare l'anello frontale
Dévisser la bague avant
Schrauben Sie den frontalen Ring ab
Desenroscar el anillo frontal

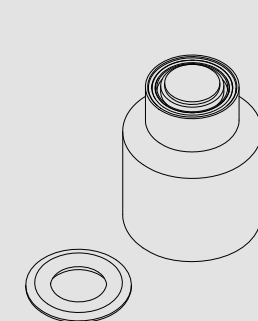

2
Remove the front ring

Estrarre l'anello frontale
Extraire la bague avant
Ziehen Sie den frontalen Ring heraus
Quitar el anillo frontal

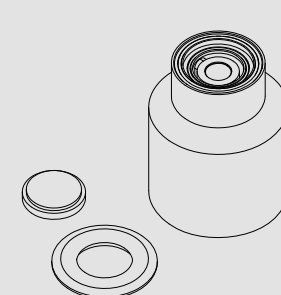

3
Remove the glass

Estrarre il vetro
Extraire la vitre
Ziehen Sie das Glas heraus
Quitar el vidrio

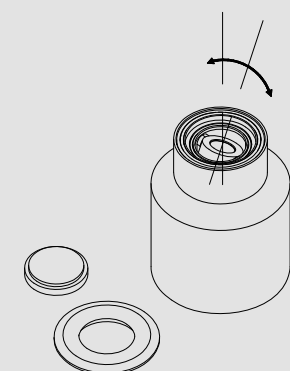

4
Direct the light source

Orientare la sorgente luminosa
Orienter la source lumineuse
Richten Sie die Leuchtquelle
Orientar la fuente luminosa

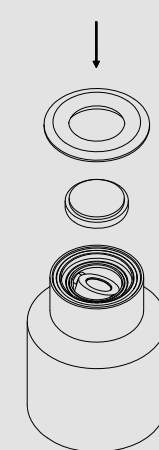

5
Replace the sealing gasket, the glass and tighten the ring

Riposizionare la guarnizione di tenuta, il vetro ed avvitare l'anello
Repositionner le joint d'étanchéité, la vitre et visser la bague
Setzen Sie die Dichtung, das Glas und den Ring wieder ein
Volver a colocar la guarnición de estanqueidad, el vidrio y atornillar el anillo

JENA 6

design: Roberto Mantovani

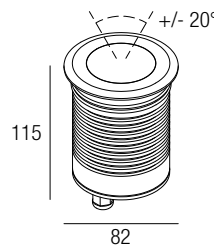

Supply current

Alimentazione
Courant d'alimentation
Stromversorgung
Corriente de alimentación
350-500 mA (V, 8, 7V)

Power

Potenza
Puissance
Bestuekung
Potencia
3-6 W

Series wiring

Cablaggio in serie
Câblage en série
Verkabelung in Serie
Cableado en serie

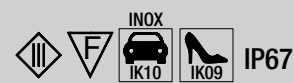

Photometric diagrams

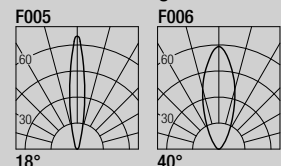

CCT/CRI/Flux

	350mA	500mA
2700K	267 lm	384 lm
3000K	279 lm	400 lm
4200K	309 lm	462 lm
6000K	342 lm	495 lm

CRI85

2-Step MacAdam

Code Construction

Costruzione del codice - Construction du code produit
Bau der Produkt-Code - Construcción del código de producto

XJ21 X X X

Finishing

Finitura
Finitions
Oberflächenfinish
Acabados

	G	N	K	Z
Grey	Black	COR-TEN	INOX AISI 316L	
Grigio	Nero		Steel	
Gris	Noir		Acciaio	
Grau	Schwarz		Acier	
	Negro		Stahl	
			Acero	

Color Temperature

	0	1	2	3	6	7	8
Temperatura colore	2700K	3000K	4200K	6000K	Blue	Green	Red
Température couleur					Blu	Verde	Rosso
Temperaturabhängige Farbe					Bleu	Vert	Rouge
Temperatura de color					Blau	Grün	Rot
					Azul		Rojo

Beam angle

	1	2
Apertura di fascio	18°	40°
Angle de faisceau		
Strahlwinkel		
Ángulo del haz		

Accessories

Accessori - Accessoires
Zubehör - Accesorios

CSXJ02

Recessing box
Controcassa
Boîtier d'encastrement
Eingieβgehäuse
Caja de empotrar

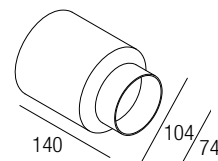

LXJ2101

Low luminance louver
Filtro antiabbagliamento
Filtre basse luminance
Geringe Leuchtdichte-Filter
Filtro de baja luminancia



Note: the filter must be ordered together with the lighting fixture - **Nota:** il filtro deve essere ordinato congiuntamente all'apparecchio - **Note:** le filtre doit être commandé en même temps que l'appareil - **Anmerkung:** muss der Filter zusammen mit Leuchtkörper bestellt werden
Nota: el filtro debe pedirse junto con la luminaria

Note: cable cut to measure on request
Nota: cavo a misura disponibile su richiesta
Note: câble sur mesure disponible sur demande
Anmerkung: kundenspezifisches Kabel auf Anfrage erhältlich
Nota: cable a medida disponible a petición

Drivers

Alimentatori - Alimentateurs
Netzteile - Alimentadores

350 mA		500 mA	
on/off	dimnable	on/off	dimnable
AL1034 (1..3) 30mm IP20	AL4000 (1..4) 72mm IP20 PUSH 0/1..10V	AL1074 (1..2) 30mm IP20	AL4010 (1..4) 72mm IP20 PUSH 0/1..10V
AL1035 (1..3) 40mm IP20	AL4051 (1..4) 72mm IP20 DALI 2	AL1077 (1..2) 40mm IP20	AL4151 (1..4) 72mm IP20 DALI 2
AL1037 (1..5) 55mm IP20 S.P.	AL4053 (1..4) 96mm IP20 PUSH IGBT-TRIAC	AL1084 (1..3) 55mm IP20 S.P.	AL4153 (1..4) 56mm IP20 PUSH IGBT-TRIAC
AL9011 (1..4) 44mm IP67	AL8035 (2..4) IP67 DALI	AL9051 (1..3) 44mm IP67	AL8050 (2..4) IP67 DALI



MAL 10

design: Lapo Grassellini

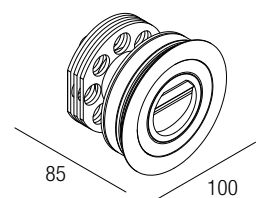

Supply current

Alimentazione
Courant d'alimentation
Stromversorgung
Corriente de alimentación

250 mA (V, 36V)

Power

Potenza
Puissance
Bestuekung
Potencia

10 W

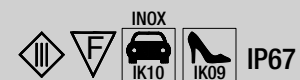

Photometric diagrams

F985

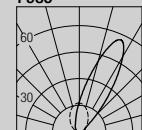

WALL WASHER

CCT/CRI/Flux

	CRI85	CRI93
2700K	890 lm	840 lm
3000K	1000 lm	930 lm
4000K	1040 lm	960 lm

CRI85 - CRI93

2-Step MacAdam

- [DATASHEET ▶](#)
- [INSTALLATION MANUAL ▶](#)
- [CERTIFICATIONS ▶](#)
- [LDT-IES ▶](#)
- [DRAWINGS ▶](#)



Code Construction

Costruzione del codice - Construction du code produit
Bau der Produkt-Code - Construcción del código de producto

MA1 X X X

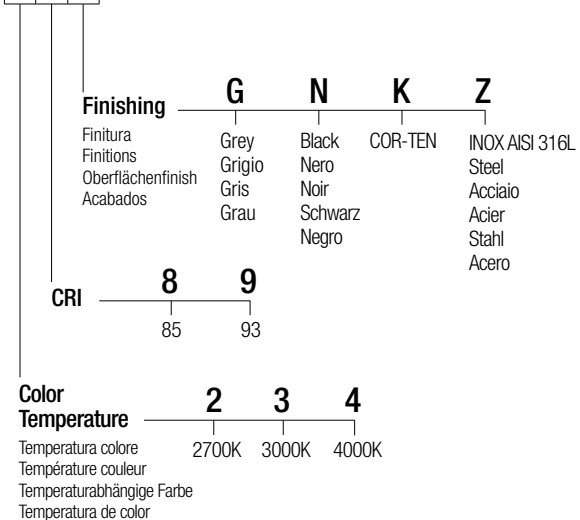

Accessories

Accessori - Accessoires
Zubehör - Accesorios

CSDS20

Recessing box
Controcassa
Boîtier d'encastrement
Eingießgehäuse
Caja de empotrar

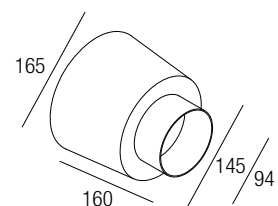

Note: cable cut to measure on request
Nota: cavo a misura disponibile su richiesta
Note: câble sur mesure disponible sur demande
Anmerkung: kundenspezifisches Kabel auf Anfrage erhältlich
Nota: cable a medida disponible a petición

Drivers

Alimentatori - Alimentateurs
Netzteile - Alimentadores

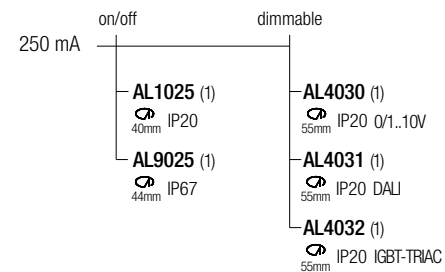

MAL 20

design: Lapo Grassellini

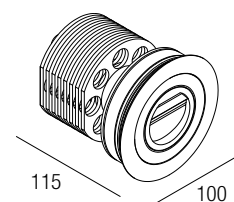

Supply current

Alimentazione
Courant d'alimentation
Stromversorgung
Corriente de alimentación
500 mA (V, 36V)

Power

Potenza
Puissance
Bestuekung
Potencia
20 W

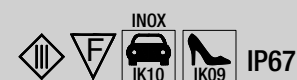

Photometric diagrams

F985

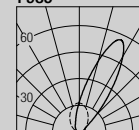

WALL WASHER

CCT/CRI/Flux

	CRI85	CRI93
2700K	1830 lm	1700 lm
3000K	2000 lm	1830 lm
4000K	2100 lm	1950 lm

CRI85 - CRI93

2-Step MacAdam



Code Construction

Costruzione del codice - Construction du code produit
Bau der Produkt-Code - Construcción del código de producto

MA2 X X X

Finishing	G	N	K	Z
Finitura Finitions Oberflächenfinish Acabados	Grey Grigio Gris Grau	Black Nero Noir Schwarz Negro	COR-TEN	INOX AISI 316L Steel Acciaio Acier Stahl Acero
CRI	8 85	9 93		

Color Temperature	2	3	4
Temperatura colore Température couleur Temperaturabhängige Farbe Temperatura de color	2700K	3000K	4000K

Accessories

Accessori - Accessoires
Zubehör - Accesorios

CSDS20

Recessing box
Controcassa
Boîtier d'encastrement
Eingießgehäuse
Caja de empotrar

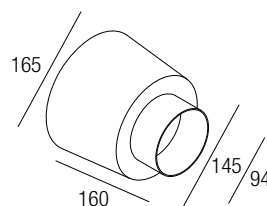

Note: cable cut to measure on request
Nota: cavo a misura disponibile su richiesta
Note: câble sur mesure disponible sur demande
Anmerkung: kundenspezifisches Kabel auf Anfrage erhältlich
Nota: cable a medida disponible a petición

Drivers

Alimentatori - Alimentateurs
Netzteile - Alimentadores

on/off	dimmmable
500 mA	
AL1084 (1) 30mm IP20 S.P.	AL4010 (1) 72mm IP20 PUSH 0/1..10V
AL9052 (1) 44mm IP67	AL4151 (1) 72mm IP20 DALI 2
	AL4153 (1) 56mm IP20 PUSH IGBT-TRIAC
	AL8050 (1) IP67 DALI



BUNGA

design: Roberto Mantovani

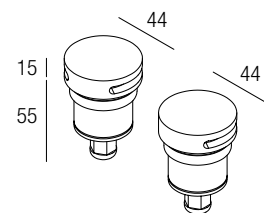

Supply current

Alimentazione
 Courant d'alimentation
 Stromversorgung
 Corriente de alimentación
350-500 mA (V_i 2,9V)

Power

Potenza
 Pouissance
 Bestuekung
 Potencia
1-2 W

Series wiring

Cablaggio in serie
 Câblage en série
 Verkabelung in Serie
 Cableado en serie

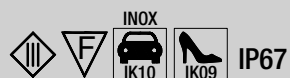

CCT/CRI/Flux

	350mA	500mA
2700K	89 lm	128 lm
3000K	93 lm	133 lm
4200K	103 lm	154 lm
6000K	114 lm	165 lm

CRI85

2-Step MacAdam

Code Construction

Costruzione del codice - Construction du code produit
 Bau der Produkt-Code - Construcción del código de producto

BG X X X

Color	0	1	2	3	6	7	8
Temperature	2700K	3000K	4200K	6000K	Blue	Green	Red
Temperatura colore					Blu	Verde	Rosso
Température couleur					Bleu	Vert	Rouge
Temperaturabhängige Farbe					Blau	Grün	Rot
Temperatura de color					Azul	Grün	Rojo

Finishing	B	G	N	K	Z
Finitura	White	Grey	Black	COR-TEN	INOX AISI 316L
Finitions	Bianco	Grigio	Nero		Steel
Oberflächenfinish	Blanc	Gris	Noir		Acciaio
Acabados	Weiß	Grau	Schwarz		Acier
	Blanco		Negro		Stahl
					Acero

Emission	1	2
Emissione	Single	Double
Émission	Singola	Doppia
	Única	Doppel
	Einzel	Doble
	Único	

Accessories

Accessori - Accessoires
 Zubehör - Accesorios

CSXT01

Recessing box
 Controcassa
 Boîtier d'encastrement
 Eingieβgehäuse
 Caja de empotrar

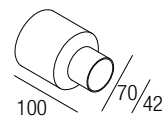

Note: cable cut to measure on request
Nota: cavo a misura disponibile su richiesta
Note: câble sur mesure disponible sur demande
Anmerkung: kundenspezifisches Kabel auf Anfrage erhältlich
Nota: cable a medida disponible a petición

Drivers

Alimentatori - Alimentateurs
 Netzteile - Alimentadores

350 mA	on/off	dimmable
AL1034 (1.11)	30mm IP20	AL4000 (1.12)
AL1035 (1.11)	40mm IP20	AL4051 (2.14)
AL1037 (1.16)	55mm IP20 S.P.	AL4053 (1.14)
AL9011 (1.12)	44mm IP67	AL8035 (4.16)
		IP67 DALI
500 mA	on/off	dimmable
AL1074 (1.7)	30mm IP20	AL4010 (1.12)
AL1077 (1.6)	40mm IP20	AL4151 (2.14)
AL1084 (1.11)	55mm IP20 S.P.	AL4153 (1.14)
AL9051 (1.11)	44mm IP67	AL8050 (4.16)
		IP67 DALI



MINIAIR

design: Roberto Mantovani

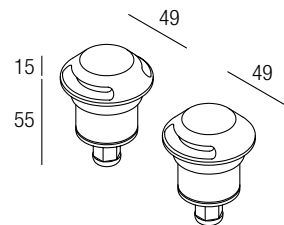

Supply current

Alimentazione
 Courant d'alimentation
 Stromversorgung
 Corriente de alimentación
350-500 mA (V, 2,9V)

Power

Potenza
 Pouissance
 Bestuekung
 Potencia
1-2 W

Series wiring

Cablaggio in serie
 Câblage en série
 Verkabelung in Serie
 Cableado en serie

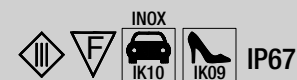

CCT/CRI/Flux

	350mA	500mA
2700K	89 lm	128 lm
3000K	93 lm	133 lm
4200K	103 lm	154 lm
6000K	114 lm	165 lm

CRI85

2-Step MacAdam

Code Construction

Costruzione del codice - Construction du code produit
 Bau der Produkt-Code - Construcción del código de producto

MXR X X X

Color Temperature	0	1	2	3	6	7	8
Temperatura colore	2700K	3000K	4200K	6000K	Blue	Green	Red
Température couleur					Blu	Verte	Rosso
Temperaturabhängige Farbe					Bleu	Vert	Rouge
Temperatura de color					Blau	Grün	Rot
					Azul		Rojo

Finishing	G	N	K	Z
Finitura	Grey	Black	COR-TEN	INOX AISI 316L
Finitions	Grigio	Nero		Steel
Oberflächenfinish	Gris	Noir		Acciaio
Acabados	Grau	Schwarz		Acier
		Negro		Stahl
				Acero

Emission	1	2
Emissione	Single	Double
Emission	Singola	Doppia
	Unique	Doppel
	Einzel	Doble
	Único	

Accessories

Accessori - Accessoires
 Zubehör - Accesorios

CSXT01

Recessing box
 Controcassa
 Boîtier d'encastrement
 Eingieβgehäuse
 Caja de empotrar

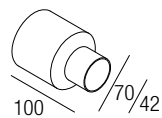

Note: cable cut to measure on request
Nota: cavo a misura disponibile su richiesta
Note: câble sur mesure disponible sur demande
Anmerkung: kundenspezifisches Kabel auf Anfrage erhältlich
Nota: cable a medida disponible a petición

Drivers

Alimentatori - Alimentateurs
 Netzteile - Alimentadores

350 mA	on/off	dimmable
AL1034 (1..11)	30mm IP20	AL4000 (1..12) 72mm IP20 PUSH 0/1..10V
AL1035 (1..11)	40mm IP20	AL4051 (2..14) 72mm IP20 DALI 2
AL1037 (1..16)	55mm IP20 S.P.	AL4053 (1..14) 56mm IP20 PUSH IGBT-TRIAC
AL9011 (1..12)	44mm IP67	AL8035 (4..16) IP67 DALI

500 mA	on/off	dimmable
AL1074 (1..7)	30mm IP20	AL4010 (1..12) 72mm IP20 PUSH 0/1..10V
AL1077 (1..6)	40mm IP20	AL4151 (2..14) 72mm IP20 DALI 2
AL1084 (1..11)	55mm IP20 S.P.	AL4153 (1..14) 56mm IP20 PUSH IGBT-TRIAC
AL9051 (1..11)	44mm IP67	AL8050 (4..16) IP67 DALI

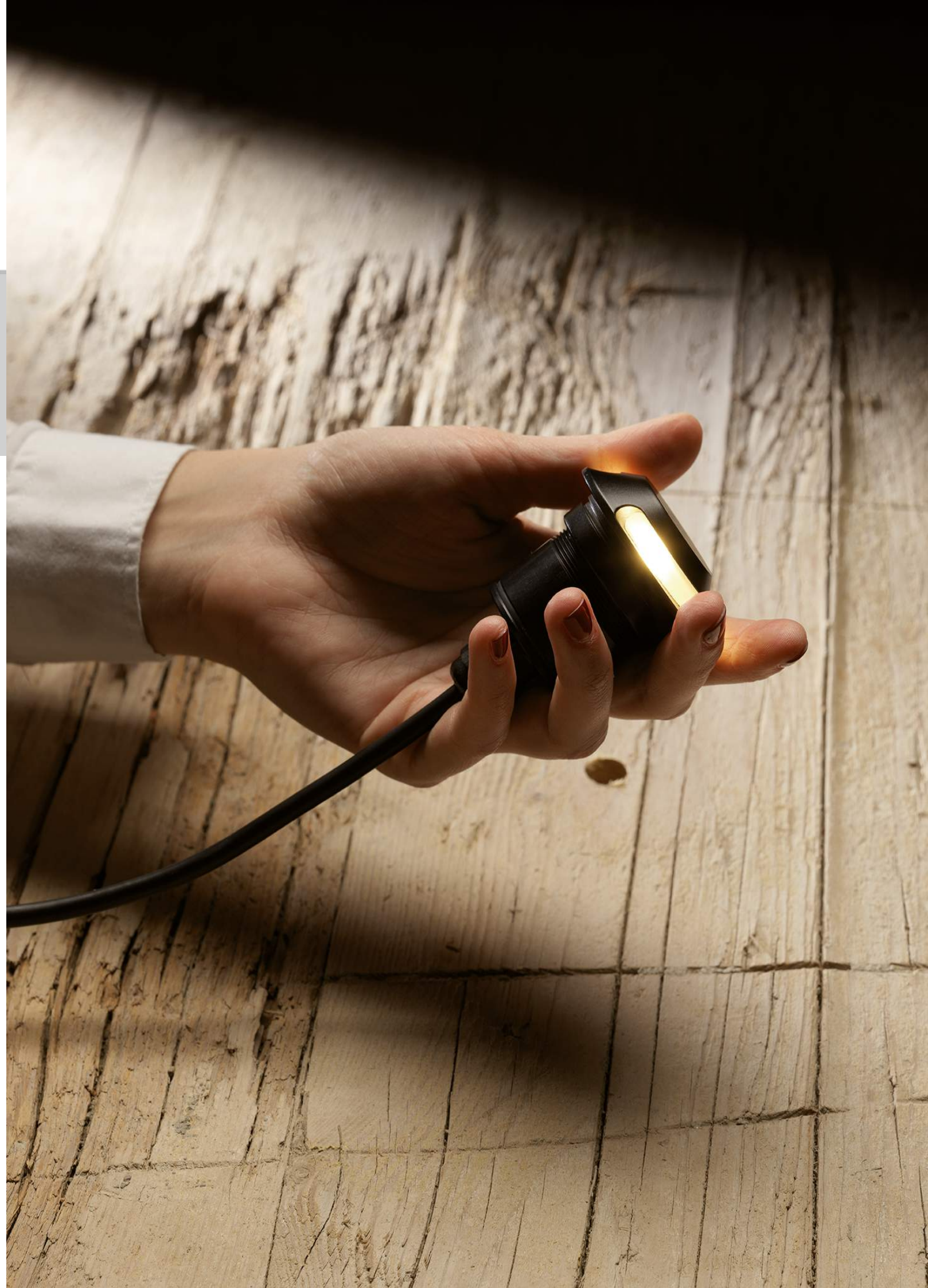

AIR 6

design: Roberto Mantovani

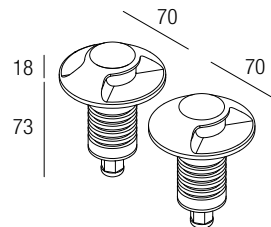

Supply current

Alimentazione
 Courant d'alimentation
 Stromversorgung
 Corriente de alimentación
350-500 mA (V, 8, 7V)

Power

Potenza
 Pouissance
 Bestuekung
 Potencia
3-6 W

Series wiring

Cablaggio in serie
 Câblage en série
 Verkabelung in Serie
 Cableado en serie

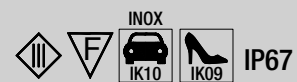

CCT/CRI/Flux

	350mA	500mA
2700K	267 lm	384 lm
3000K	279 lm	400 lm
4200K	309 lm	462 lm
6000K	342 lm	495 lm

CRI85

2-Step MacAdam

Code Construction

Costruzione del codice - Construction du code produit
 Bau der Produkt-Code - Construcción del código de producto

XR2 X, X, X

Color Temperature	0	1	2	3	6	7	8
Temperatura colore Température couleur Temperaturabhängige Farbe Temperatura de color	2700K	3000K	4200K	6000K	Blue Blu Bleu Blau Azul	Green Verde Vert Grün	Red Rosso Rouge Rot Rojo
Finishing	G	N	K	Z			
Finitura Finitions Oberflächenfinish Acabados	Grey Grigio Gris Grau	Black Nero Noir Schwarz Negro	COR-TEN	INOX AISI 316L Steel Acciaio Acier Stahl Acero			
Emission	1	2					
Emissione Émission	Single Singola Unique Einzel Único	Double Doppia Doppel Doble					

Accessories

Accessori - Accessoires
 Zubehör - Accesorios

CSXT01

Recessing box
 Controcassa
 Boîtier d'encastrement
 Eingieβgehäuse
 Caja de empotrar

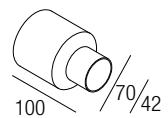

Note: cable cut to measure on request
Nota: cavo a misura disponibile su richiesta
Note: câble sur mesure disponible sur demande
Anmerkung: kundenspezifisches Kabel auf Anfrage erhältlich
Nota: cable a medida disponible a petición

Drivers

Alimentatori - Alimentateurs
 Netzteile - Alimentadores

350 mA	on/off	dimmable
AL1034 (1.3) 30mm IP20	AL4000 (1.4) 72mm IP20 PUSH 0/1..10V	
AL1035 (1.3) 40mm IP20	AL4051 (1.4) 72mm IP20 DALI 2	
AL1037 (1.5) 55mm IP20 S.P.	AL4053 (1.4) 56mm IP20 PUSH IGBT-TRIAC	
AL9011 (1.4) 44mm IP67	AL8035 (2.4) IP67 DALI	
500 mA	on/off	dimmable
AL1074 (1.2) 30mm IP20	AL4010 (1.4) 72mm IP20 PUSH 0/1..10V	
AL1077 (1.2) 40mm IP20	AL4151 (1.4) 72mm IP20 DALI 2	
AL1084 (1.3) 55mm IP20 S.P.	AL4153 (1.4) 56mm IP20 PUSH IGBT-TRIAC	
AL9051 (1.3) 44mm IP67	AL8050 (2.4) IP67 DALI	

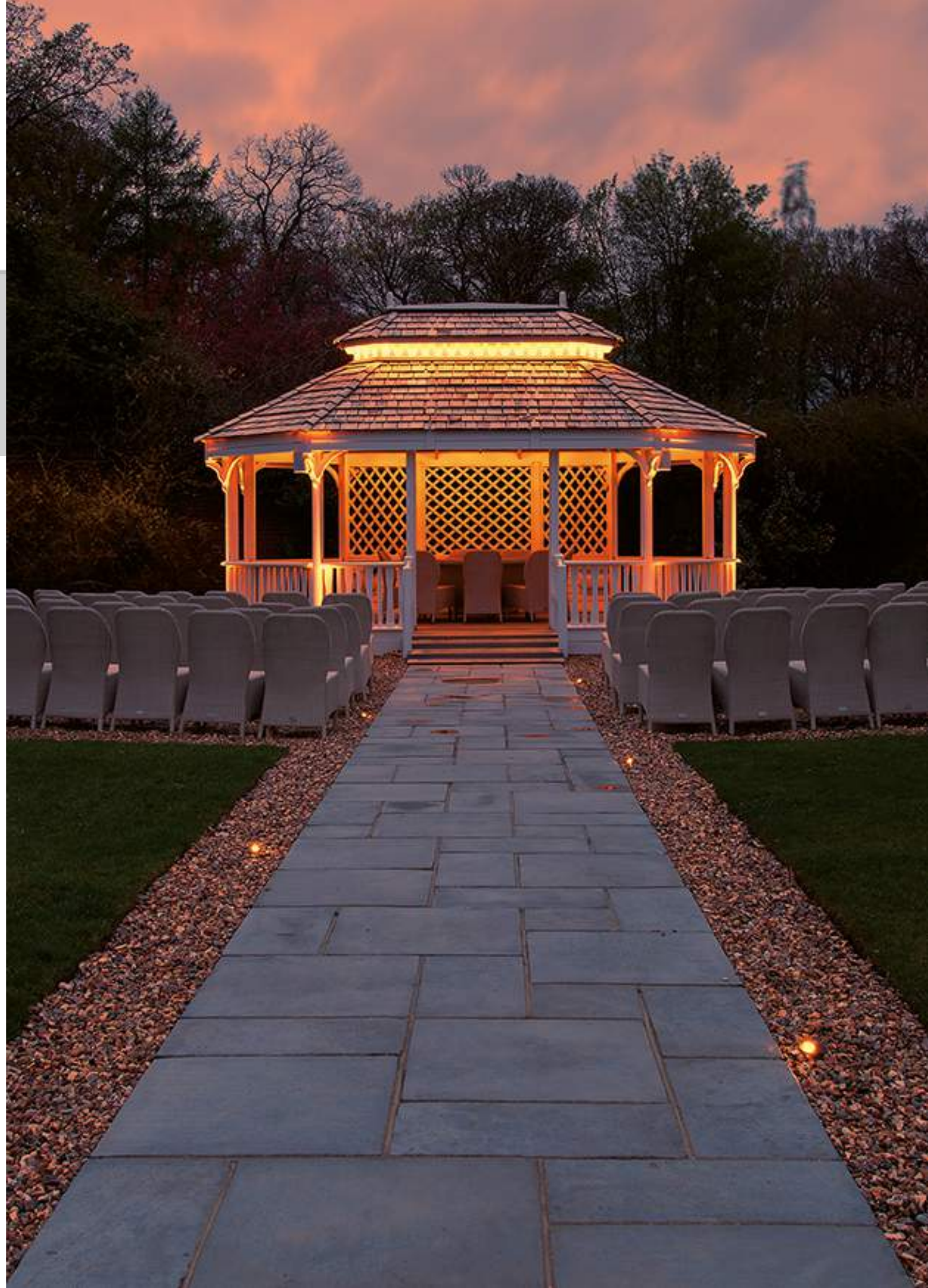



KING

design: Roberto Mantovani

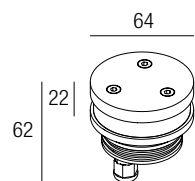

Supply current

Alimentazione
Courant d'alimentation
Stromversorgung
Corriente de alimentación
350-500 mA (V, 8, 7V)

Power

Potenza
Puissance
Bestuekung
Potencia
3-6 W

Series wiring

Cablaggio in serie
Câblage en série
Verkabelung in Serie
Cableado en serie

[DATASHEET](#) [INSTALLATION MANUAL](#)

[CERTIFICATIONS](#) [LDT-IES](#) [DRAWINGS](#)



CCT/CRI/Flux

	350mA	500mA
2700K	267 lm	384 lm
3000K	279 lm	400 lm
4200K	309 lm	462 lm
6000K	342 lm	495 lm

CRI85

2-Step MacAdam

Code Construction

Costruzione del codice - Construction du code produit
Bau der Produkt-Code - Construcción del código de producto

KG0 X X

Color

Temperature

Temperatura colore
Température couleur
Temperaturabhängige Farbe
Temperatura de color

0 1 2 3 6 7 8

0	1	2	3	6	7	8
2700K	3000K	4200K	6000K	Blue	Green	Red
				Bleu	Vert	Rouge
				Blau	Grün	Rot
				Blau	Grün	Rot
				Azul		Rojo

Finishing

Finitura
Finitions
Oberflächenfinish
Acabados

G	N	K	Z
Grey	Black	COR-TEN	INOX AISI 316L
Grigio	Nero		Steel
Gris	Noir		Acciaio
Grau	Schwarz		Acier
	Negro		Stahl
			Acero

Accessories

Accessori - Accessoires
Zubehör - Accesorios

CSDS10

Recessing box
Controcassa
Boîtier d'encastrement
Eingießgehäuse
Caja de empotrar

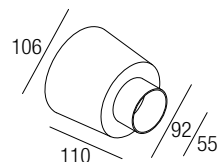

Note: cable cut to measure on request
Nota: cavo a misura disponibile su richiesta
Note: câble sur mesure disponible sur demande
Anmerkung: kundenspezifisches Kabel auf Anfrage erhältlich
Nota: cable a medida disponible a petición

Drivers

Alimentatori - Alimentateurs
Netzteile - Alimentadores

350 mA		500 mA	
on/off	dimmable	on/off	dimmable
AL1034 (1.3) 30mm IP20	AL4000 (1.4) 72mm IP20 PUSH 0/1..10V	AL1074 (1.2) 30mm IP20	AL4010 (1.4) 72mm IP20 PUSH 0/1..10V
AL1035 (1.3) 40mm IP20	AL4051 (1.4) 72mm IP20 DALI 2	AL1077 (1.2) 40mm IP20	AL4151 (1.4) 72mm IP20 DALI 2
AL1037 (1.5) 55mm IP20 S.P.	AL4053 (1.4) 56mm IP20 PUSH IGBT-TRIAC	AL1084 (1.3) 55mm IP20 S.P.	AL4153 (1.4) 56mm IP20 PUSH IGBT-TRIAC
AL9011 (1.4) 44mm IP67	AL8035 (2.4) IP67 DALI	AL9051 (1.3) 44mm IP67	AL8050 (2.4) IP67 DALI



YAGA

design: Roberto Mantovani

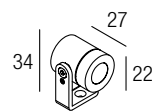

Supply current

Alimentazione
Courant d'alimentation
Stromversorgung
Corriente de alimentación

350-500 mA (V, 2,9V)

Power

Potenza
Puissance
Bestuekung
Potencia

1-2 W

Series wiring

Cablaggio in serie
Câblage en série
Verkabelung in Serie
Cableado en serie



Photometric diagrams

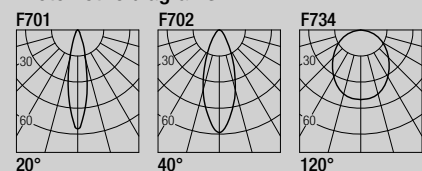

CCT/CRI/Flux

	350mA	500mA
2700K	89 lm	128 lm
3000K	93 lm	133 lm
4200K	103 lm	154 lm
6000K	114 lm	165 lm

CRI85

2-Step MacAdam

Code Construction

Costruzione del codice - Construction du code produit
Bau der Produkt-Code - Construcción del código de producto

YG1, X, X, X

Beam angle	S	M	W
Apertura di fascio	20°	40°	120°
Angle de faisceau			
Strahlwinkel			
Ángulo del haz			

Color Temperature	0	1	2	3	6	7	8
Temperatura colore	2700K	3000K	4200K	6000K	Blue	Green	Red
Température couleur					Bleu	Vert	Rouge
Temperaturabhängige Farbe					Blau	Grün	Rot
Temperatura de color					Azul	Rojo	

Finishing	2	5	6
Finitura	Aluminium	Black	Bronze
Finitions	Aluminium	Nero	Bronzo
Oberflächenfinish	Aluminium	Noir	Bronce
Acabados	Aluminio	Schwarz	Bronce

Accessories

Accessori - Accessoires
Zubehör - Accesorios

XP00MY

Earth spike
Picchetto
Piquet de terre
Erdspieß
Pico de la tierra

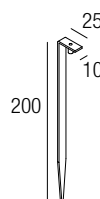

XNTY02 XNTY05 XNTY06

XNTY02	XNTY05	XNTY06
Aluminium	Black	Bronze
Alluminio	Nero	Bronzo
Aluminium	Noir	Bronce
Aluminio	Schwarz	
	Negro	

Antiglare snoot
Snoot antiabbagliamento
Snoot antiéblouissement
Blendschutz Snoot
Snoot antideslumbrante



XXT02

Tree strap
Cinghia per albero
Courroie d'arbre
Baumbügel
Correa del árbol

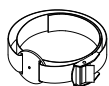

Note: cable cut to measure on request
Nota: cavo a misura disponibile su richiesta
Note: câble sur mesure disponible sur demande
Anmerkung: kundenspezifisches Kabel auf Anfrage erhältlich
Nota: cable a medida disponible a petición

Drivers

Alimentatori - Alimentateurs
Netzteile - Alimentadores

350 mA		500 mA	
on/off	dimmable	on/off	dimmable
AL1034 (1.11) 30mm IP20	AL4000 (1.12) 72mm IP20 PUSH 0/1..10V	AL1074 (1.7) 30mm IP20	AL4010 (1.12) 72mm IP20 PUSH 0/1..10V
AL1035 (1.11) 40mm IP20	AL4051 (2.14) 72mm IP20 DALI 2	AL1077 (1.6) 40mm IP20	AL4151 (2.14) 72mm IP20 DALI 2
AL1037 (1.16) 55mm IP20 S.P.	AL4053 (1.14) 56mm IP20 PUSH IGBT-TRIAC	AL1084 (1.11) 55mm IP20 S.P.	AL4153 (1.14) 56mm IP20 PUSH IGBT-TRIAC
AL9011 (1.12) 44mm IP67	AL8035 (4.16) IP67 DALI	AL9051 (1.11) 44mm IP67	AL8050 (4.16) IP67 DALI



CASSIUS

design: Roberto Mantovani

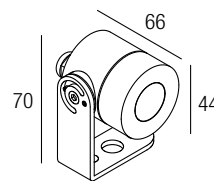

Supply current

Alimentazione
Courant d'alimentation
Stromversorgung
Corriente de alimentación

24 VDC

Power

Potenza
Puissance
Bestuekung
Potencia

2 W

Parallel wiring

Cablaggio in parallelo
Câblage en parallèle
Verkabelung in parallel
Cableado en paralelo



Photometric diagrams

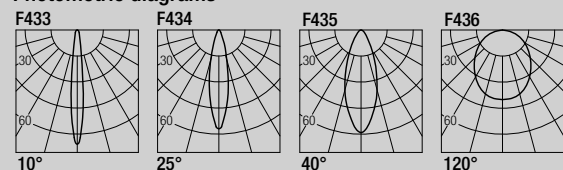

CCT/CRI/Flux

2700K — 128 lm
3000K — 133 lm
4200K — 154 lm

CRI85

2-Step MacAdam

Code Construction

Costruzione del codice - Construction du code produit
Bau der Produkt-Code - Construcción del código de producto

CAS X.X.X

Beam angle
Apertura di fascio
Angle de faisceau
Strahlwinkel
Ángulo del haz

S 10° **M** 25° **F** 40° **W** 120°

Color Temperature
Temperatura colore
Température couleur
Temperaturabhängige Farbe
Temperatura de color

2 2700K **3** 3000K **4** 4200K

Finishing

2	Aluminium Alluminio Aluminium Acabados	5	Black Nero Noir Schwarz Negro	6	Bronze Bronzo Bronce
----------	---	----------	---	----------	----------------------------

Drivers

Alimentatori - Alimentateurs
Netzteile - Alimentadores

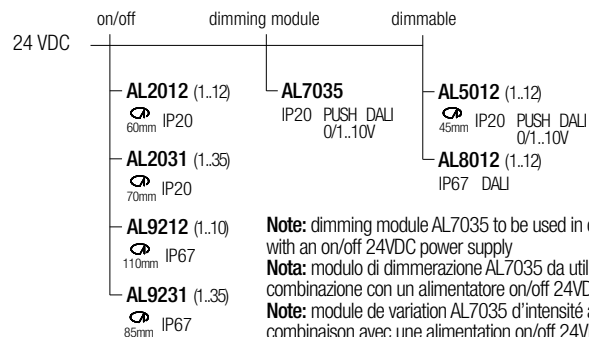

Note: dimming module AL7035 to be used in combination with an on/off 24VDC power supply
Nota: modulo di dimmerazione AL7035 da utilizzare in combinazione con un alimentatore on/off 24VDC
Note: module de variation AL7035 d'intensité à utiliser en combinaison avec une alimentation on/off 24VDC
Anmerkung: Dimmmodul AL7035 zur Verwendung in Kombination mit einem on/off 24VDC-Netzteil
Nota: módulo de regulación AL7035 se utiliza en combinación con una fuente de alimentación on/off 24VDC

Accessories

Accessori - Accessoires
Zubehör - Accesorios

XP0022

Earth spike
Picchetto
Piquet de terre
Erdspeiß
Pico de la tierra

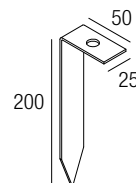

XP0200

Aluminium
Alluminio
Aluminium
Aluminio

XP0500

Black
Nero
Noir
Schwarz
Negro

XP0600

Bronze
Bronzo
Bronce

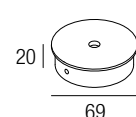

Base
Basis

LCAS01

Low luminance louver
Filtro antiabbagliamento
Filtre basse luminance
Geringe Leuchtdichte-Filter
Filtro de baja luminancia



Note: il filtro deve essere ordinato congiuntamente all'apparecchio
Note: the filter must be ordered together with the lighting fixture
Note: le filtre doit être commandé en même temps que l'appareil
Anmerkung: muss der Filter zusammen mit Leuchtkörper bestellt werden
Nota: el filtro debe pedirse junto con la luminaria

XNTC02

Aluminium
Alluminio
Aluminium
Aluminio

XNTC05

Black
Nero
Noir
Schwarz
Negro

XNTC06

Bronze
Bronzo
Bronce

Antiglare snoot

Snoot antiabbagliamento
Snoot antiéblouissement
Blendschutz Snoot
Snoot antideslumbrante



XXT01

Tree strap
Cinghia per albero
Courroie d'arbre
Baumbügel
Correa del árbol



Note: cable cut to measure on request
Nota: cavo a misura disponibile su richiesta
Note: câble sur mesure disponible sur demande
Anmerkung: kundenspezifisches Kabel auf Anfrage erhältlich
Nota: cable a medida disponible a petición



MAHALO

design: Roberto Mantovani

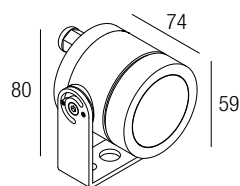

Supply current

Alimentazione
Courant d'alimentation
Stromversorgung
Corriente de alimentación

24 VDC

Power

Potenza
Puissance
Bestuekung
Potencia

7 W

Parallel wiring

Cablaggio in parallelo
Câblage en parallèle
Verkabelung in parallel
Cableado en paralelo



[DATASHEET](#) ▶ [INSTALLATION MANUAL](#) ▶

[CERTIFICATIONS](#) ▶ [LDT-IES](#) ▶ [DRAWINGS](#) ▶



Photometric diagrams

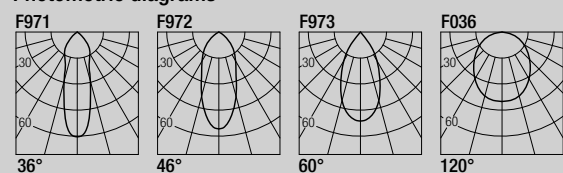

CCT/CRI/Flux

	CRI85	CRI93
2700K	630 lm	590 lm
3000K	700 lm	650 lm
4000K	730 lm	670 lm

CRI85 - CRI93

2-Step MacAdam

Note: cable cut to measure on request
Nota: cavo a misura disponibile su richiesta
Note: câble sur mesure disponible sur demande
Anmerkung: kundenspezifisches Kabel auf Anfrage erhältlich
Nota: cable a medida disponible a petición

Code Construction

Costruzione del codice - Construction du code produit
Bau der Produkt-Code - Construcción del código de producto

MH1 X X X X

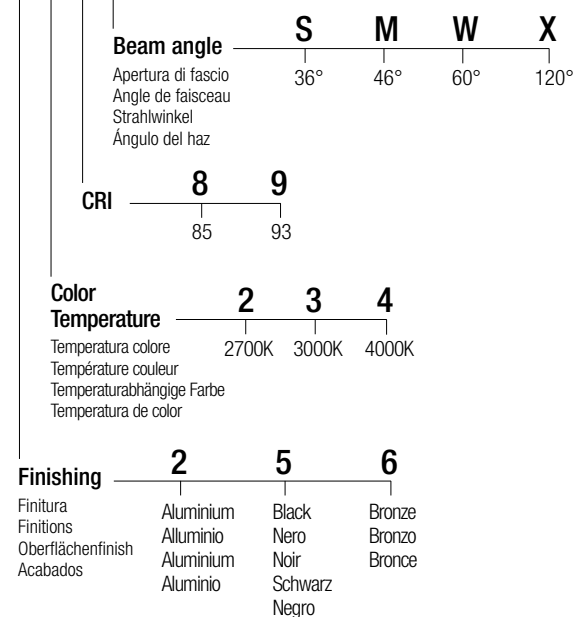

Accessories

Accessori - Accessoires
Zubehör - Accesorios

ESMH101

Earth spike
Picchetto
Piquet de terre
Erdspeiß
Pico de la tierra

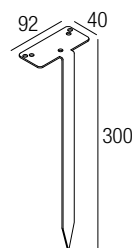

XP0200

Aluminium
Aluminio
Aluminium
Aluminio

XP0500

Black
Nero
Noir
Schwarz
Negro

XP0600

Bronze
Bronzo
Bronce

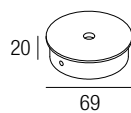

Base
Basis

XNTX202

Aluminium
Aluminio
Aluminium
Aluminio

XNTX205

Black
Nero
Noir
Schwarz
Negro

XNTX206

Bronze
Bronzo
Bronce

Antiglare snoot
Snoot antiabbagliamento
Snoot antiéblouissement
Blendschutz Snoot
Snoot antideslumbrante



LMH101

Low luminance louver
Filtro antiabbagliamento
Filtre basse luminance
Geringe Leuchtdichte-Filter
Filtro de baja luminancia



Note: the filter must be ordered together with the lighting fixture - **Nota:** il filtro deve essere ordinato congiuntamente all'apparecchio - **Note:** le filtre doit être commandé en même temps que l'appareil - **Anmerkung:** muss der Filter zusammen mit Leuchtkörper bestellt werden
Nota: el filtro debe pedirse junto con la luminaria

XXT01

Tree strap
Cinghia per albero
Courroie d'arbre
Baumbügel
Correa del árbol

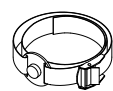

Drivers

Alimentatori - Alimentateurs
Netzteile - Alimentadores

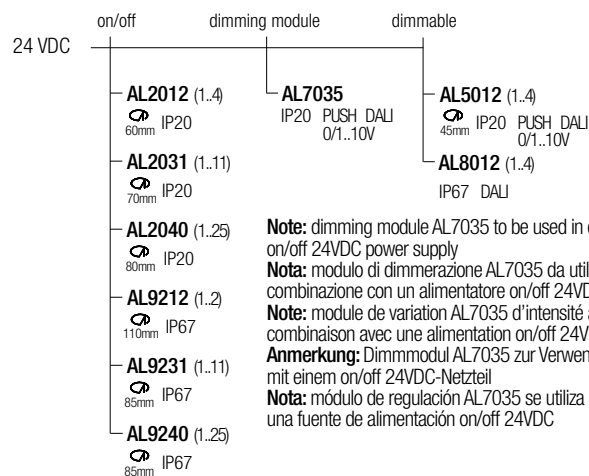

Note: dimming module AL7035 to be used in combination with an on/off 24VDC power supply
Nota: modulo di dimmerazione AL7035 da utilizzare in combinazione con un alimentatore on/off 24VDC
Note: module de variation AL7035 d'intensité à utiliser en combinaison avec une alimentation on/off 24VDC
Anmerkung: Dimmmodul AL7035 zur Verwendung in Kombination mit einem on/off 24VDC-Netzteil
Nota: módulo de regulación AL7035 se utiliza en combinación con una fuente de alimentación on/off 24VDC

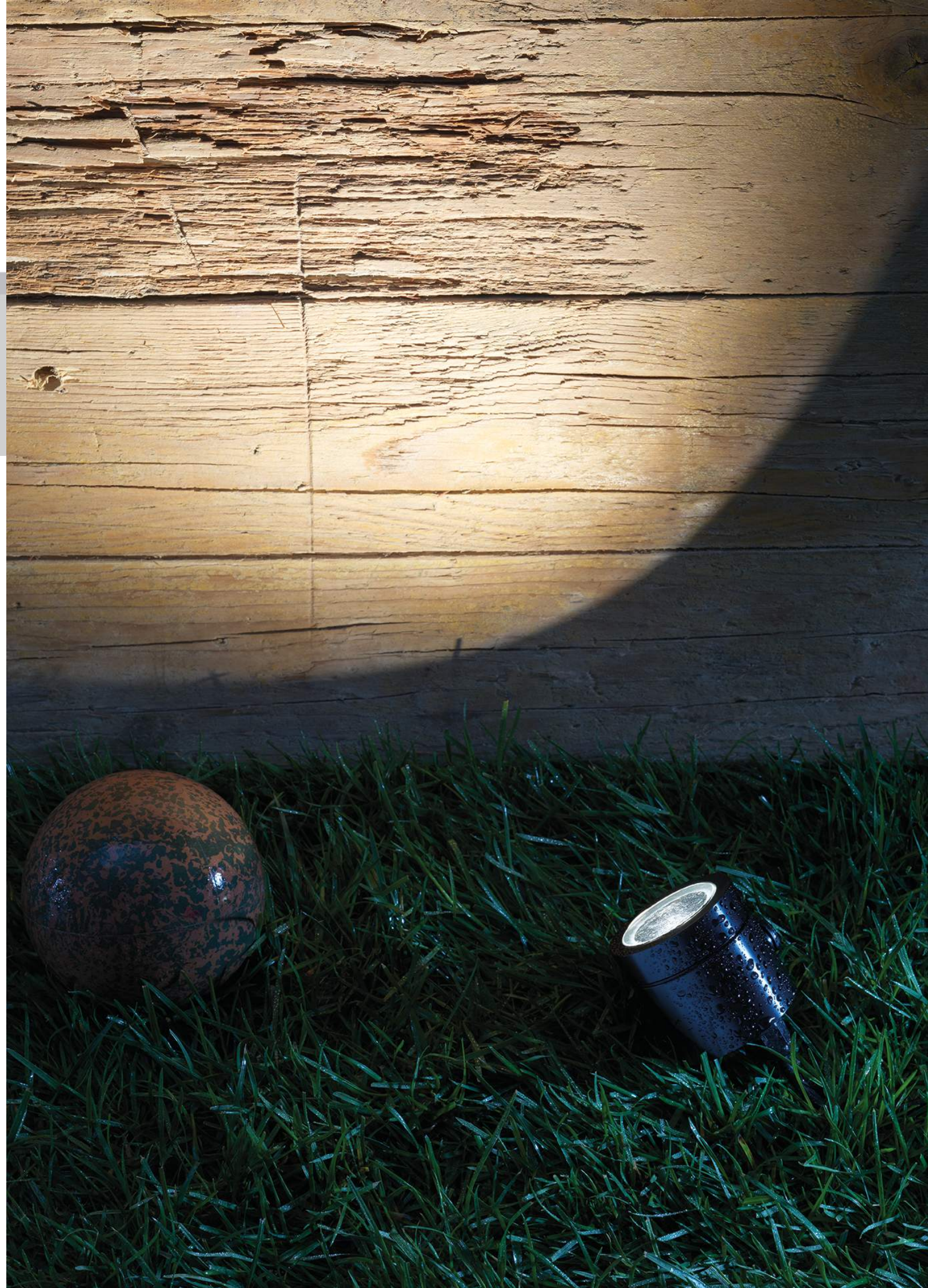

MAUNA 6

design: Rod&Todd

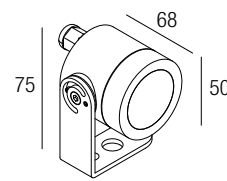

Supply current

Alimentazione
Courant d'alimentation
Stromversorgung
Corriente de alimentación
500 mA (V_i 9V)

Power

Potenza
Puissance
Bestuekung
Potencia
6 W

Series wiring

Cablaggio in serie
Câblage en série
Verkabelung in Serie
Cableado en serie



Photometric diagrams

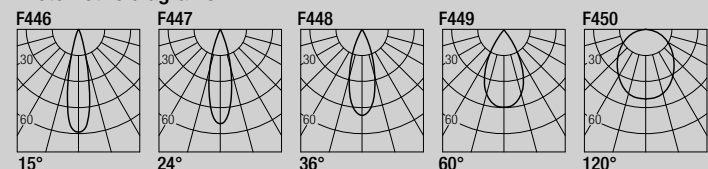

CCT/CRI/Flux

2700K — 540 lm
3000K — 600 lm
4000K — 620 lm

CRI98
2-Step MacAdam

Note: cable cut to measure on request
Nota: cavo a misura disponibile su richiesta
Note: câble sur mesure disponible sur demande
Anmerkung: kundenspezifisches Kabel auf Anfrage erhältlich
Nota: cable a medida disponible a petición

Code Construction

Costruzione del codice - Construction du code produit
Bau der Produkt-Code - Construcción del código de producto

MU6 X X X

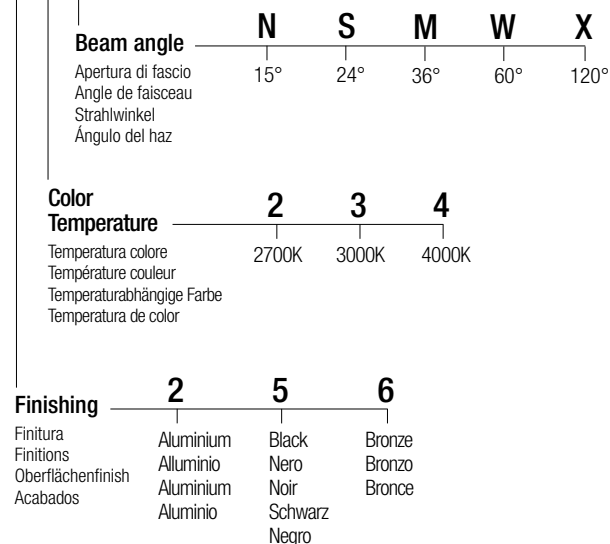

Drivers

Alimentatori - Alimentateurs
Netzteile - Alimentadores

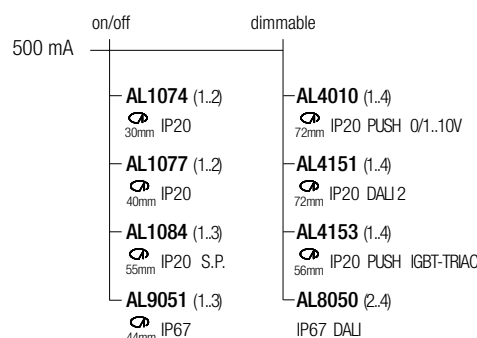

Accessories

Accessori - Accessoires
Zubehör - Accesorios

XP0022

Earth spike
Picchetto
Piquet de terre
Erdspeiß
Pico de la tierra

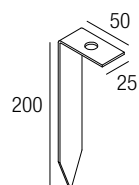

XP0200

Aluminium
Aluminio
Aluminium
Aluminio

XP0500

Black
Nero
Noir
Schwarz
Negro

XP0600

Bronze
Bronzo
Bronce

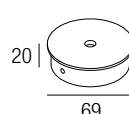

Base
Basis

LMU601

Low luminance louver
Filtro antiabbagliamento
Filtre basse luminance
Geringe Leuchtdichte-Filter
Filtro de baja luminancia



Note: the filter must be ordered together with the lighting fixture - **Nota:** il filtro deve essere ordinato congiuntamente all'apparecchio - **Note:** le filtre doit être commandé en même temps que l'appareil - **Anmerkung:** muss der Filter zusammen mit Leuchtkörper bestellt werden
Nota: el filtro debe pedirse junto con la luminaria

XNTM02

Aluminium
Aluminio
Aluminium
Aluminio

XNTM05

Black
Nero
Noir
Schwarz
Negro

XNTM06

Bronze
Bronzo
Bronce

Antiglare snoot

Snoot antiabbagliamento
Snoot antiéblouissement
Blendschutz Snoot
Snoot antideslumbrante



XXT01

Tree strap
Cinghia per albero
Courroie d'arbre
Baumbügel
Correa del árbol



MAUNA 724

design: Rod&Todd

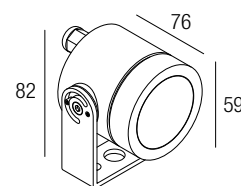

Supply current

Alimentazione
Courant d'alimentation
Stromversorgung
Corriente de alimentación
24 VDC

Power

Potenza
Puissance
Bestuekung
Potencia
7 W

Parallel wiring

Cablaggio in parallelo
Câblage en parallèle
Verkabelung in parallel
Cableado en paralelo



Photometric diagrams

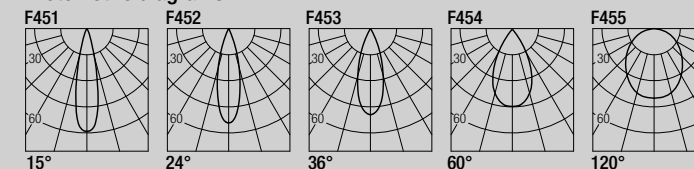

CCT/CRI/Flux

CRI85 CRI93
2700K — 630 lm 590 lm
3000K — 700 lm 650 lm
4000K — 730 lm 670 lm

CRI85 - CRI93
2-Step MacAdam

Note: cable cut to measure on request
Nota: cavo a misura disponibile su richiesta
Note: câble sur mesure disponible sur demande
Anmerkung: kundenspezifisches Kabel auf Anfrage erhältlich
Nota: cable a medida disponible a petición

Code Construction

Costruzione del codice - Construction du code produit
Bau der Produkt-Code - Construcción del código de producto

MU24 X X X X

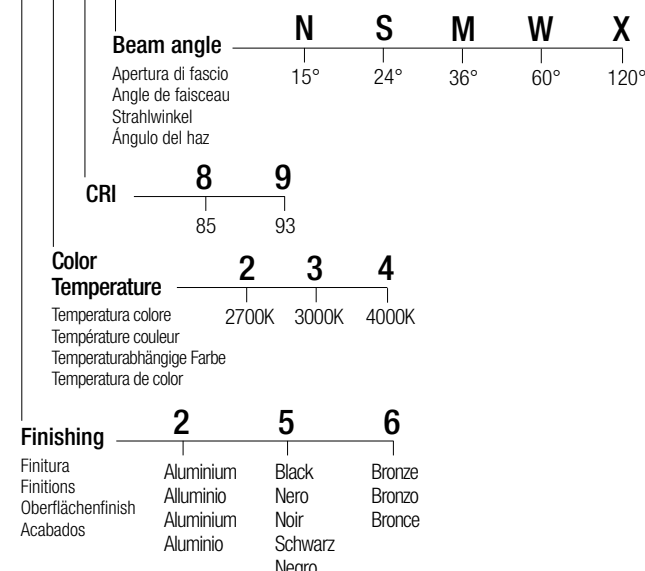

Drivers

Alimentatori - Alimentateurs
Netzteile - Alimentadores

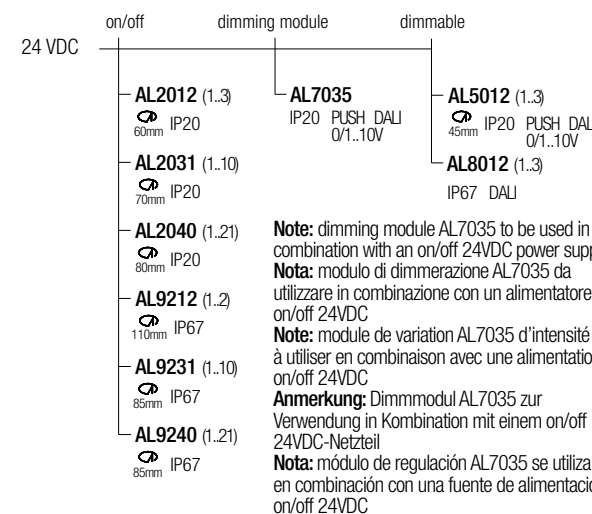

Accessories

Accessori - Accessoires
Zubehör - Accesorios

ESMU2401

Earth spike
Picchetto
Piquet de terre
Erdspeiß
Pico de la tierra

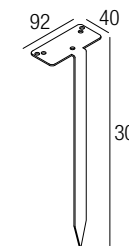

XP0200

Aluminium
Aluminio
Aluminium
Aluminio

XP0500

Black
Nero
Noir
Schwarz
Negro

XP0600

Bronze
Bronzo
Bronce

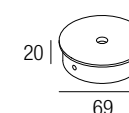

Base
Basis

LMU2401

Low luminance louver
Filtro antiabbagliamento
Filtre basse luminance
Geringe Leuchtdichte-Filter
Filtro de baja luminancia



Note: the filter must be ordered together with the lighting fixture - **Nota:** il filtro deve essere ordinato congiuntamente all'apparecchio - **Note:** le filtre doit être commandé en même temps que l'appareil - **Anmerkung:** muss der Filter zusammen mit Leuchtkörper bestellt werden
Nota: el filtro debe pedirse junto con la luminaria

XNTX202

Aluminium
Aluminio
Aluminium
Aluminio

XNTX205

Black
Nero
Noir
Schwarz
Negro

XNTX206

Bronze
Bronzo
Bronce

Antiglare snoot

Snoot antiabbagliamento
Snoot antiéblouissement
Blendschutz Snoot
Snoot antideslumbrante

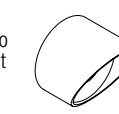

XXT01

Tree strap
Cinghia per albero
Courroie d'arbre
Baumbügel
Correa del árbol



OLU 2

design: Roberto Mantovani

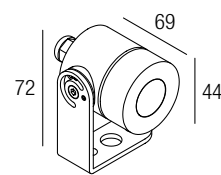

Supply current

Alimentazione
Alimentazione
Courant d'alimentation
Stromversorgung
Corriente de alimentación
350-500 mA (V, 2,9V)

Power

Potenza
Potissance
Câblage en série
Verkabelung
Cableado en serie
1-2 W

Series wiring

Cablaggio in serie
Câblage en série
Verkabelung in Serie
Cableado en serie



Photometric diagrams

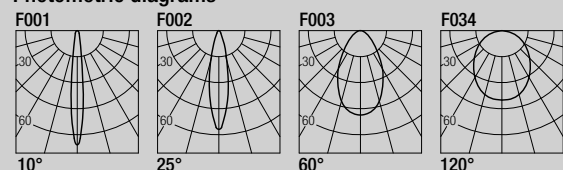

CCT/CRI/Flux

	350mA	500mA
2700K	89 lm	128 lm
3000K	93 lm	133 lm
4200K	103 lm	154 lm
6000K	114 lm	165 lm

CRI85

2-Step MacAdam

Code Construction

Costruzione del codice - Construction du code produit
Bau der Produkt-Code - Construcción del código de producto

LU1 X X X

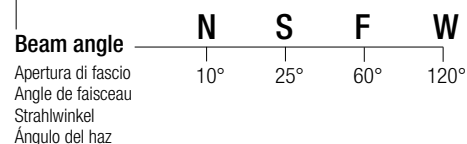

Color Temperature

	0	1	2	3	6	7	8
Temperatura colore	2700K	3000K	4200K	6000K	Blue	Green	Red
Température couleur	2700K	3000K	4200K	6000K	Bleu	Vert	Rouge
Temperaturabhängige Farbe	2700K	3000K	4200K	6000K	Blau	Grün	Rot
Temperatura de color	2700K	3000K	4200K	6000K	Azul	Grün	Rojo

Finishing

	2	5	6
Finitura	Aluminium	Black	Bronze
Finitions	Alluminio	Nero	Bronzo
Oberflächenfinish	Aluminium	Noir	Bronze
Acabados	Aluminio	Schwarz	Bronce

Drivers

Alimentatori - Alimentateurs
Netzteile - Alimentadores

350 mA		500 mA	
on/off	dimmable	on/off	dimmable
AL1034 (1.11) 30mm IP20	AL4000 (1.12) 72mm IP20 PUSH 0/1..10V	AL1074 (1.7) 30mm IP20	AL4010 (1.12) 72mm IP20 PUSH 0/1..10V
AL1035 (1.11) 40mm IP20	AL4051 (2.14) 72mm IP20 DALI 2	AL1077 (1.6) 40mm IP20	AL4151 (2.14) 72mm IP20 DALI 2
AL1037 (1.16) 55mm IP20 S.P.	AL4053 (1.14) 56mm IP20 PUSH IGBT-TRIAC	AL1084 (1.11) 55mm IP20 S.P.	AL4153 (1.14) 56mm IP20 PUSH IGBT-TRIAC
AL9011 (1.12) 44mm IP67	AL8035 (4.16) IP67 DALI	AL9051 (1.11) 44mm IP67	AL8050 (4.16) IP67 DALI

Accessories

Accessori - Accessoires
Zubehör - Accesorios

XP0022

Earth spike
Picchetto
Piquet de terre
Erdspieß
Pico de la tierra

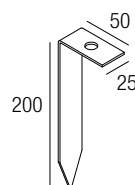

XP0200

Aluminium
Aluminio
Aluminium
Aluminio

XP0500

Black
Nero
Noir
Schwarz
Negro

XP0600

Bronze
Bronzo
Bronce

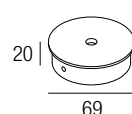

Base
Basis

XNTC02

Aluminium
Aluminio
Aluminium
Aluminio

XNTC05

Black
Nero
Noir
Schwarz
Negro

XNTC06

Bronze
Bronzo
Bronce

Antiglare snoot
Snoot antiabbagliamento
Snoot antiéblouissement
Blendschutz Snoot
Snoot antideslumbrante

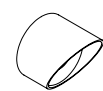

XXT01

Tree strap
Cinghia per albero
Courroie d'arbre
Baumbügel
Correa del árbol



Note: cable cut to measure on request
Nota: cavo a misura disponibile su richiesta
Note: câble sur mesure disponible sur demande
Anmerkung: kundenspezifisches Kabel auf Anfrage erhältlich
Nota: cable a medida disponible a petición



OLU 6

design: Roberto Mantovani

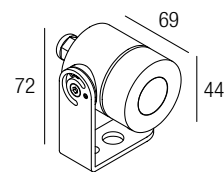

Supply current

Alimentazione
Alimentazione
Courant d'alimentation
Stromversorgung
Corriente de alimentación
350-500 mA (V, 8,7V)

Power

Potenza
Potenza
Puissance
Bestuekung
Bestuekung
Potencia
3-6 W

Series wiring

Cablaggio in serie
Cablaggio in serie
Câblage en série
Verkabelung in Serie
Cableado en serie



Photometric diagrams

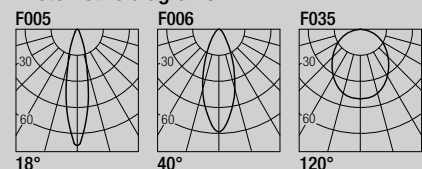

CCT/CRI/Flux

	350mA	500mA
2700K	267 lm	384 lm
3000K	279 lm	400 lm
4200K	309 lm	462 lm
6000K	342 lm	495 lm

CRI85

2-Step MacAdam

Code Construction

Costruzione del codice - Construction du code produit
Bau der Produkt-Code - Construcción del código de producto

LU2 X X X

Beam angle

Apertura di fascio
Angle de faisceau
Strahlwinkel
Angulo del haz

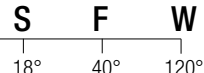

Color Temperature

Temperatura colore
Température couleur
Temperaturabhängige Farbe
Temperatura de color

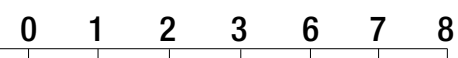

Finishing

Finitura
Finitions
Oberflächenfinish
Acabados

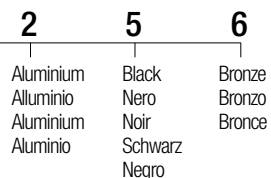

Accessories

Accessori - Accessoires
Zubehör - Accesorios

XP0022

Earth spike
Picchetto
Piquet de terre
Erdspieß
Pico de la tierra

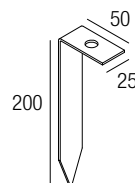

XP0200

Aluminium
Alluminio
Aluminium
Aluminio

XP0500

Black
Nero
Noir
Schwarz
Negro

XP0600

Bronze
Bronzo
Bronce

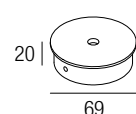

Base
Basis

XNTC02

Aluminium
Alluminio
Aluminium
Aluminio

XNTC05

Black
Nero
Noir
Schwarz
Negro

XNTC06

Bronze
Bronzo
Bronce

Antiglare snoot
Snoot antiabbagliamento
Snoot antiéblouissement
Blendschutz Snoot
Snoot antideslumbrante



XXT01

Tree strap
Cinghia per albero
Courroie d'arbre
Baumbügel
Correa del árbol

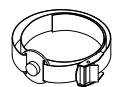

Drivers

Alimentatori - Alimentateurs
Netzteile - Alimentadores

350 mA		500 mA	
on/off	dimnable	on/off	dimnable
AL1034 (1..3) 30mm IP20	AL4000 (1..4) 72mm IP20 PUSH 0/1..10V	AL1074 (1..2) 30mm IP20	AL4010 (1..4) 72mm IP20 PUSH 0/1..10V
AL1035 (1..3) 40mm IP20	AL4051 (1..4) 72mm IP20 DALI 2	AL1077 (1..2) 40mm IP20	AL4151 (1..4) 72mm IP20 DALI 2
AL1037 (1..5) 55mm IP20 S.P.	AL4053 (1..4) 56mm IP20 PUSH IGBT-TRIAC	AL1084 (1..3) 55mm IP20 S.P.	AL4153 (1..4) 56mm IP20 PUSH IGBT-TRIAC
AL9011 (1..4) 44mm IP67	AL8035 (2..4) IP67 DALI	AL9051 (1..3) 44mm IP67	AL8050 (2..4) IP67 DALI

Note: cable cut to measure on request
Nota: cavo a misura disponibile su richiesta
Note: câble sur mesure disponible sur demande
Anmerkung: kundenspezifisches Kabel auf Anfrage erhältlich
Nota: cable a medida disponible a petición



BRUTUS 10

design: Roberto Mantovani

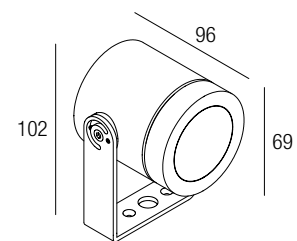

Supply current

Alimentazione
Courant d'alimentation
Stromversorgung
Corriente de alimentación

500 mA (V_i 18V)

Power

Potenza
Puissance
Bestuekung
Potencia

10 W

Series wiring

Cablaggio in serie
Câblage en série
Verkabelung in Serie
Cableado en serie



Photometric diagrams

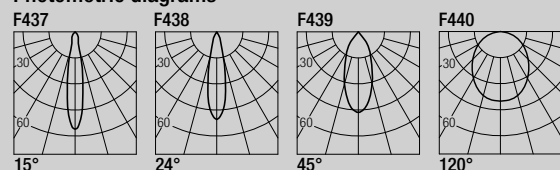

CCT/CRI/Flux

	CRI85	CRI93
2700K	890 lm	840 lm
3000K	1000 lm	930 lm
4000K	1040 lm	960 lm

CRI85 - CRI93
2-Step MacAdam

Code Construction

Costruzione del codice - Construction du code produit
Bau der Produkt-Code - Construcción del código de producto

BRT1 X X X X

Beam angle	S	M	F	W
Apertura di fascio	15°	24°	45°	120°
Angle de faisceau				
Strahlwinkel				
Ángulo del haz				
CRI	8	9		
	85	93		
Color Temperature	2	3	4	
Temperatura colore	2700K	3000K	4000K	
Température couleur				
Temperaturabhängige Farbe				
Temperatura de color				
Finishing	2	5	6	
Finitura	Aluminium	Black	Bronze	
Finitions	Aluminium	Nero	Bronzo	
Oberflächenfinish	Aluminium	Noir	Bronce	
Acabados	Aluminio	Schwarz	Bronce	
		Negro		

Accessories

Accessori - Accessoires
Zubehör - Accesorios

ESBRT101

Earth spike
Picchetto
Piquet de terre
Erdspeiß
Pico de la tierra

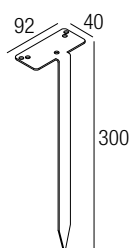

LBRT101

Low luminance louver
Filtro antiabbagliamento
Filtre basse luminance
Geringe Leuchtdichte-Filter
Filtro de baja luminancia



Nota: il filtro deve essere ordinato congiuntamente all'apparecchio
Note: the filter must be ordered together with the lighting fixture
Note: le filtre doit être commandé en même temps que l'appareil
Anmerkung: muss der Filter zusammen mit Leuchtkörper bestellt werden
Nota: el filtro debe pedirse junto con la luminaria

XNTB102

Aluminium
Aluminio
Aluminium
Aluminio

XNTB105

Black
Nero
Noir
Schwarz
Negro

XNTB106

Bronze
Bronzo
Bronce

Antiglare snoot

Snoot antiabbagliamento
Snoot antiéblouissement
Blendschutz Snoot
Snoot antideslumbrante

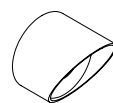

XXT01

Tree strap
Cinghia per albero
Courroie d'arbre
Baumbügel
Correa del árbol

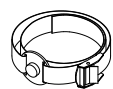

Note: cable cut to measure on request
Nota: cavo a misura disponibile su richiesta
Note: câble sur mesure disponible sur demande
Anmerkung: kundenspezifisches Kabel auf Anfrage erhältlich
Nota: cable a medida disponible a petición

Drivers

Alimentatori - Alimentateurs
Netzteile - Alimentadores

on/off	dimmable
AL1074 (1) 30mm IP20	AL4010 (1,2) 72mm IP20 PUSH 0/1..10V
AL1077 (1) 40mm IP20	AL4151 (1,2) 72mm IP20 DALI 2
AL1084 (1,2) 55mm IP20 S.P.	AL4153 (1,2) 50mm IP20 PUSH IGBT-TRIAC
AL9051 (1) 44mm IP67	AL8050 (1,2) IP67 DALI



BRUTUS 20

design: Roberto Mantovani

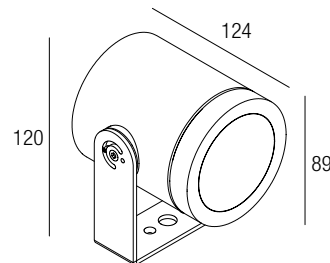

Supply current
 Alimentazione
 Courant d'alimentation
 Stromversorgung
 Corriente de alimentación
500 mA (V, 36V)

Power
 Potenza
 Puissance
 Bestuekung
 Potencia
20 W



Photometric diagrams

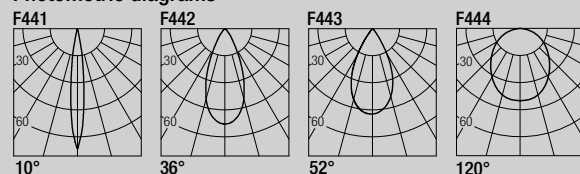

CCT/CRI/Flux

	CRI85	CRI93
2700K	1830 lm	1700 lm
3000K	2000 lm	1830 lm
4000K	2100 lm	1950 lm

CRI85 - CRI93
2-Step MacAdam

Code Construction

Costruzione del codice - Construction du code produit
 Bau der Produkt-Code - Construcción del código de producto

BRT2 X X X X

Beam angle S M F W
 Apertura di fascio 10° 36° 52° 120°
 Angle de faisceau
 Strahlwinkel
 Angulo del haz

CRI 8 9
 85 93

Color Temperature 2 3 4
 Temperatura colore 2700K 3000K 4000K
 Température couleur
 Temperaturabhängige Farbe
 Temperatura de color

Finishing 2 5 6
 Finitura Aluminium Black Bronze
 Finitions Aluminium Nero Bronzo
 Oberflächenfinish Aluminium Noir Bronze
 Acabados Alumínio Negro Bronce

Accessories

Accessori - Accessoires
 Zubehör - Accesorios

ESBRT201

Earth spike
 Picchetto
 Piquet de terre
 Erdspließ
 Pico de la tierra

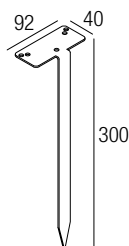

LBRT201

Low luminance louver
 Filtro antiabbagliamento
 Filtre basse luminance
 Geringe Leuchtdichte-Filter
 Filtro de baja luminancia



Nota: il filtro deve essere ordinato congiuntamente all'apparecchio
Note: the filter must be ordered together with the lighting fixture
Note: le filtre doit être commandé en même temps que l'appareil
Anmerkung: muss der Filter zusammen mit Leuchtkörper bestellt werden
Nota: el filtro debe pedirse junto con la luminaria

XNTB202

Aluminium
 Aluminium
 Aluminium
 Aluminio

XNTB205

Black
 Nero
 Noir
 Schwarz
 Negro

XNTB206

Bronze
 Bronzo
 Bronze

Antiglare snoot

Snoot antiabbagliamento
 Snoot antiéblouissement
 Blendschutz Snoot
 Snoot antideslumbrante

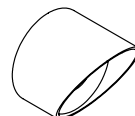

XXT01

Tree strap
 Cinghia per albero
 Courroie d'arbre
 Baumbügel
 Correa del árbol



Note: cable cut to measure on request
Nota: cavo a misura disponibile su richiesta
Note: câble sur mesure disponible sur demande
Anmerkung: kundenspezifisches Kabel auf Anfrage erhältlich
Nota: cable a medida disponible a petición

Drivers

Alimentatori - Alimentateurs
 Netzteile - Alimentadores

on/off	dimmmable
AL1084 (1) 55mm IP20 S.P.	AL4010 (1) 72mm IP20 PUSH 0/1..10V
AL9052 (1) 50mm IP67	AL4151 (1) 72mm IP20 DALI 2
	AL4153 (1) 60mm IP20 PUSH IGBT-TRIAC
	AL8050 (1) IP67 DALI



ALOHA 2

design: Roberto Mantovani

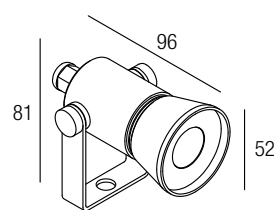

Supply current

Alimentazione
 Courant d'alimentation
 Stromversorgung
 Corriente de alimentación
350-500 mA (V, 2,9V)

Power

Potenza
 Pouissance
 Bestuekung
 Potencia
1-2 W

Series wiring

Cablaggio in serie
 Câblage en série
 Verkabelung in Serie
 Cableado en serie



CCT/CRI/Flux

	350mA	500mA
2700K	89 lm	128 lm
3000K	93 lm	133 lm
4200K	103 lm	154 lm
6000K	114 lm	165 lm

CRI85

2-Step MacAdam

Photometric diagrams

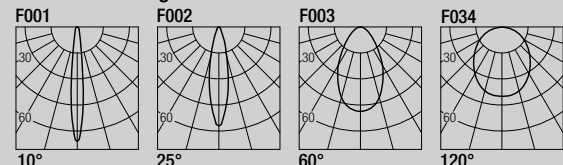

Code Construction

Costruzione del codice - Construction du code produit
 Bau der Produkt-Code - Construcción del código de producto

XP1 X X X

Beam angle	N	S	F	W
Apertura di fascio	10°	25°	60°	120°
Angle de faisceau				
Strahlwinkel				
Ángulo del haz				

Color Temperature	0	1	2	3	6	7	8
Temperatura colore	2700K	3000K	4200K	6000K	Blue	Green	Red
Température couleur					Bleu	Vert	Rouge
Temperaturabhängige Farbe					Blau	Grün	Rot
Temperatura de color					Azul		Rojo

Finishing	2	5	6
Finitura	Aluminium	Black	Bronze
Finitions	Aluminium	Nero	Bronzo
Oberflächenfinish	Aluminium	Noir	Bronce
Acabados	Aluminio	Schwarz	Bronce
		Negro	

Drivers

Alimentatori - Alimentateurs
 Netzteile - Alimentadores

350 mA	on/off	dimmable	500 mA	on/off	dimmable
AL1034 (1.11)	30mm IP20	AL4000 (1.12)	72mm IP20 PUSH 0/1..10V	AL1074 (1.7)	30mm IP20
AL1035 (1.11)	40mm IP20	AL4051 (2.14)	72mm IP20 DALI 2	AL1077 (1.6)	40mm IP20
AL1037 (1.16)	55mm IP20 S.P.	AL4053 (1.14)	56mm IP20 PUSH IGBT-TRIAC	AL1084 (1.11)	55mm IP20 S.P.
AL9011 (1.12)	44mm IP67	AL8035 (4.16)	IP67 DALI	AL9051 (1.11)	44mm IP67
				AL4010 (1.12)	72mm IP20 PUSH 0/1..10V
				AL4151 (2.14)	72mm IP20 DALI 2
				AL4153 (1.14)	56mm IP20 PUSH IGBT-TRIAC
				AL8050 (4.16)	

Accessories

Accessori - Accessoires
 Zubehör - Accesorios

XP0011

Earth spike
 Picchetto
 Piquet de terre
 Erdspieß
 Pico de la tierra

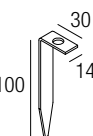

XP0200 XP0500 XP0600

Aluminium Black Bronze
 Alluminio Nero Bronzo
 Aluminium Noir Bronze
 Aluminio Schwarz Negro

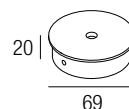

Base
 Basis

L0032 L0035 L0036

Aluminium Black Bronze
 Alluminio Nero Bronzo
 Aluminium Noir Bronze
 Aluminio Schwarz Negro

Low luminance louver
 Filtro antiabbagliamento
 Filtre basse luminance
 Geringe Leuchtdichte-Filter
 Filtro de baja luminancia



XXT01

Tree strap
 Cinghia per albero
 Courroie d'arbre
 Baumbügel
 Correa del árbol

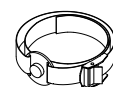

Note: cable cut to measure on request
 Nota: cavo a misura disponibile su richiesta
 Note: câble sur mesure disponible sur demande
 Anmerkung: kundenspezifisches Kabel auf Anfrage erhältlich
 Nota: cable a medida disponible a petición



ALOHA 6

design: Roberto Mantovani

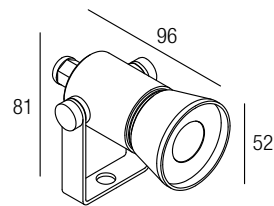

Supply current

Alimentazione
 Courant d'alimentation
 Stromversorgung
 Corriente de alimentación
350-500 mA (V, 8,7V)

Power

Potenza
 Pouissance
 Bestuekung
 Potencia
3-6 W

Series wiring

Cablaggio in serie
 Câblage en série
 Verkabelung in Serie
 Cableado en serie



CCT/CRI/Flux

	350mA	500mA
2700K	267 lm	384 lm
3000K	279 lm	400 lm
4200K	309 lm	462 lm
6000K	342 lm	495 lm

CRI85

2-Step MacAdam

Photometric diagrams

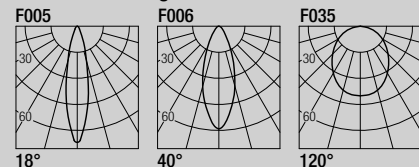

Code Construction

Costruzione del codice - Construction du code produit
 Bau der Produkt-Code - Construcción del código de producto

XP2 X X X

Beam angle

S	F	W
18°	40°	120°

Apertura di fascio
 Angle de faisceau
 Strahlwinkel
 Ángulo del haz

Color Temperature

0	1	2	3	6	7	8
2700K	3000K	4200K	6000K	Blue	Green	Red
				Blu	Verde	Rosso
				Bleu	Vert	Rouge
				Blau	Grün	Rot
				Azul		Rojo

Temperatura colore
 Température couleur
 Temperaturabhängige Farbe
 Temperatura de color

Finishing

2	5	6
Aluminium	Black	Bronze
Alluminio	Nero	Bronzo
Aluminium	Noir	Bronce
Aluminio	Schwarz	
	Negro	

Finitura
 Finitions
 Oberflächenfinish
 Acabados

Drivers

Alimentatori - Alimentateurs
 Netzteile - Alimentadores

350 mA		500 mA	
on/off	dimmbale	on/off	dimmbale
AL1034 (1..3) 30mm IP20	AL4000 (1..4) 72mm IP20 PUSH 0/1..10V	AL1074 (1..2) 30mm IP20	AL4010 (1..4) 72mm IP20 PUSH 0/1..10V
AL1035 (1..3) 40mm IP20	AL4051 (1..4) 72mm IP20 DALI 2	AL1077 (1..2) 40mm IP20	AL4151 (1..4) 72mm IP20 DALI 2
AL1037 (1..5) 55mm IP20 S.P.	AL4053 (1..4) 56mm IP20 PUSH IGBT-TRIAC	AL1084 (1..3) 55mm IP20 S.P.	AL4153 (1..4) 56mm IP20 PUSH IGBT-TRIAC
AL9011 (1..4) 44mm IP67	AL8035 (2..4) IP67 DALI	AL9051 (1..3) 44mm IP67	AL8050 (2..4) IP67 DALI

Accessories

Accessori - Accessoires
 Zubehör - Accesorios

XP0011

Earth spike
 Picchetto
 Piquet de terre
 Erdspieß
 Pico de la tierra

XP0200

Aluminium
 Alluminio
 Aluminium
 Aluminio

XP0500

Black
 Nero
 Noir
 Schwarz
 Negro

XP0600

Bronze
 Bronzo
 Bronze

Base
 Basis

L0032

Aluminium
 Alluminio
 Aluminium
 Aluminio

L0035

Black
 Nero
 Noir
 Schwarz
 Negro

L0036

Bronze
 Bronzo
 Bronze

Low luminance louver

Filtro antiabbagliamento
 Filtre basse luminance
 Geringe Leuchtdichte-Filter
 Filtro de baja luminancia

XXT01

Tree strap
 Cinghia per albero
 Courroie d'arbre
 Baumbügel
 Correa del árbol

Note: cable cut to measure on request
Nota: cavo a misura disponibile su richiesta
Note: câble sur mesure disponible sur demande
Anmerkung: kundenspezifisches Kabel auf Anfrage erhältlich
Nota: cable a medida disponible a petición



ALOHA 14

design: Roberto Mantovani

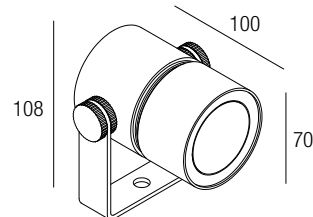

Supply current

Alimentazione
Courant d'alimentation
Stromversorgung
Corriente de alimentación
350-500 mA (V, 20,3V)

Power

Potenza
Puissance
Bestuekung
Potencia
7-14 W

Series wiring

Cablaggio in serie
Câblage en série
Verkabelung in Serie
Cableado en serie



CCT/CRI/Flux

	350mA	500mA
2700K	623 lm	896 lm
3000K	651 lm	931 lm
4200K	721 lm	1078 lm
6000K	798 lm	1155 lm

CRI85

2-Step MacAdam

Photometric diagrams

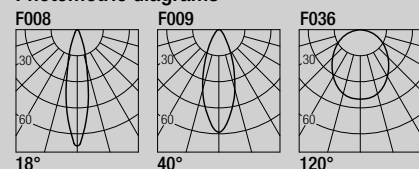

Code Construction

Costruzione del codice - Construction du code produit
Bau der Produkt-Code - Construcción del código de producto

XP3 X X X

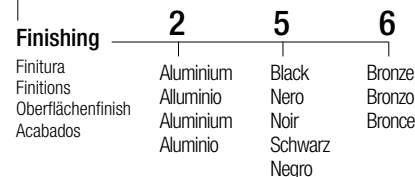
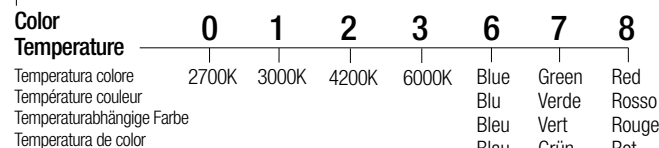
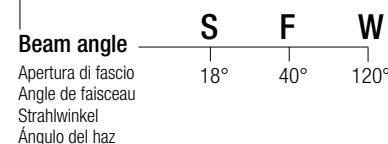

Drivers

Alimentatori - Alimentateurs
Netzteile - Alimentadores

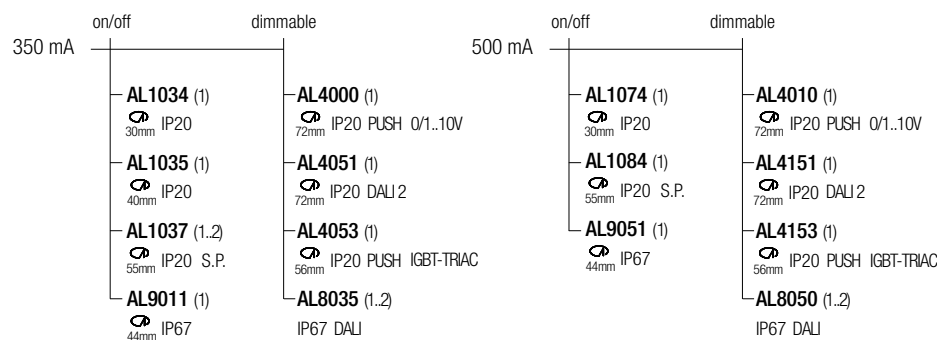

Note: cable cut to measure on request
Nota: cavo a misura disponibile su richiesta
Note: câble sur mesure disponible sur demande
Anmerkung: kundenspezifisches Kabel auf Anfrage erhältlich
Nota: cable a medida disponible a petición

Accessories

Accessori - Accessoires
Zubehör - Accesorios

XP0022

Earth spike
Picchetto
Piquet de terre
Erdspließ
Pico de la tierra

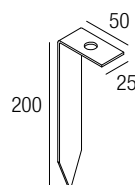

XP3200

Aluminium
Alluminio
Aluminium
Aluminio

XP3500

Black
Nero
Noir
Schwarz
Negro

XP3600

Bronze
Bronzo
Bronce

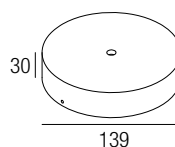

Base
Basis

L0042

Aluminium
Alluminio
Aluminium
Aluminio

L0045

Black
Nero
Noir
Schwarz
Negro

L0046

Bronze
Bronzo
Bronce

Low luminance louver

Filtro antiabbagliamento
Filtre basse luminance
Geringe Leuchtdichte-Filter
Filtro de baja luminancia



XNTX102

Aluminium
Alluminio
Aluminium
Aluminio

XNTX105

Black
Nero
Noir
Schwarz
Negro

XNTX106

Bronze
Bronzo
Bronce

Antiglare snoot

Snoot antiabbagliamento
Snoot antiéblouissement
Blendschutz Snoot
Snoot antideslumbrante



XXT01

Tree strap
Cinghia per albero
Courroie d'arbre
Baumbügel
Correa del árbol

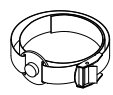

ALOHA 524

design: Roberto Mantovani

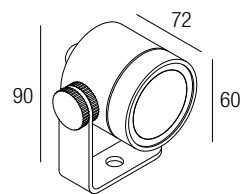

Supply current

Alimentazione
Courant d'alimentation
Stromversorgung
Corriente de alimentación

24 VDC

Power

Potenza
Puissance
Bestuekung
Potencia

6 W

Parallel wiring

Cablaggio in parallelo
Câblage en parallèle
Verkabelung in parallel
Cableado en paralelo



CCT/CRI/Flux

2700K — 384 lm
3000K — 400 lm
4200K — 462 lm
6000K — 495 lm

Photometric diagrams

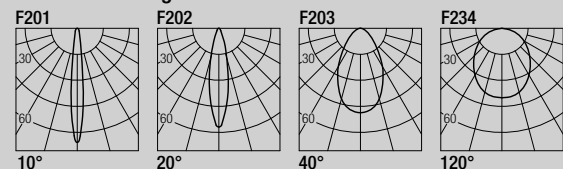

CRI85

2-Step MacAdam

Note: cable cut to measure on request
Nota: cavo a misura disponibile su richiesta
Note: câble sur mesure disponible sur demande
Anmerkung: kundenspezifisches Kabel auf Anfrage erhältlich
Nota: cable a medida disponible a petición

Code Construction

Costruzione del codice - Construction du code produit
Bau der Produkt-Code - Construcción del código de producto

XP5 | X | X | X

Beam angle	N	S	F	W
Apertura di fascio Angle de faisceau Strahlwinkel Angulo del haz	10°	20°	40°	120°

Color Temperature	0	1	2	3	6	7	8
Temperatura colore Température couleur Temperaturabhängige Farbe Temperatura de color	2700K	3000K	4200K	6000K	Blue Blu Bleu Blau Azul	Green Verde Vert Grün	Red Rosso Rouge Rot Rojo

Finishing	2	5	6
Finitura Finitions Oberflächenfinish Acabados	Aluminium Alluminio Aluminium Aluminio	Black Nero Noir Schwarz Negro	Bronze Bronzo Bronce

Drivers

Alimentatori - Alimentateurs
Netzteile - Alimentadores

24 VDC	on/off	dimming module	dimmable
AL2012 (1..4)	IP20		AL5012 (1..4) IP20 PUSH DALI 0/1..10V
AL2031 (1..11)	IP20		AL8012 (1..4) IP67 DALI
AL2040 (1..25)	IP20	AL7035	
AL9212 (1..2)	IP67		
AL9231 (1..11)	IP67		
AL9240 (1..25)	IP67		

Note: dimming module AL7035 to be used in combination with an on/off 24VDC power supply
Nota: modulo di dimmerazione AL7035 da utilizzare in combinazione con un alimentatore on/off 24VDC
Note: module de variation AL7035 d'intensité à utiliser en combinaison avec une alimentation on/off 24VDC
Anmerkung: Dimmmodul AL7035 zur Verwendung in Kombination mit einem on/off 24VDC-Netzteil
Nota: módulo de regulación AL7035 se utiliza en combinación con una fuente de alimentación on/off 24VDC

Accessories

Accessori - Accessoires
Zubehör - Accesorios

XP0022

Earth spike
Picchetto
Piquet de terre
Erdspeiß
Pico de la tierra

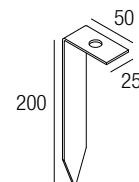

XP0200

Aluminium
Aluminio
Aluminium
Aluminio

XP0500

Black
Nero
Noir
Schwarz
Negro

XP0600

Bronze
Bronzo
Bronce

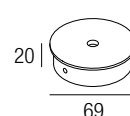

Base
Basis

L0052

Aluminium
Aluminio
Aluminium
Aluminio

L0055

Black
Nero
Noir
Schwarz
Negro

L0056

Bronze
Bronzo
Bronce

Low luminance louver
Filtro antiabbagliamento
Filtre basse luminance
Geringe Leuchtdichte-Filter
Filtro de baja luminancia



XNTX202

Aluminium
Aluminio
Aluminium
Aluminio

XNTX205

Black
Nero
Noir
Schwarz
Negro

XNTX206

Bronze
Bronzo
Bronce

Antiglare snoot
Snoot antiabbagliamento
Snoot antiéblouissement
Blendschutz Snoot
Snoot antideslumbrante

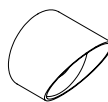

XXT01

Tree strap
Cinghia per albero
Courroie d'arbre
Baumbügel
Correa del árbol

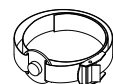

ZOOM

design: Lapo Grassellini

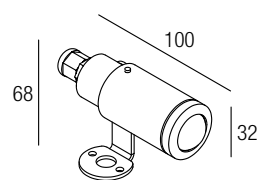

Supply current

Alimentazione
Courant d'alimentation
Stromversorgung
Corriente de alimentación
350-500 mA (V, 2,9V)

Power

Potenza
Puissance
Bestuekung
Potencia
1-2 W

Series wiring

Cablaggio in serie
Câblage en série
Verkabelung
Cableado en serie



CCT/CRI/Flux

	350mA	500mA
2700K	89 lm	128 lm
3000K	93 lm	133 lm
4200K	103 lm	154 lm
6000K	114 lm	165 lm

Adjustable optics

Ottica variabile
Optique réglable
Einstellbarer Optik
Óptica ajustable
10-55°

CRI85

2-Step MacAdam

Code Construction

Costruzione del codice - Construction du code produit
Bau der Produkt-Code - Construcción del código de producto

ZM1 X₁ X₂

Color Temperature	0	1	2	3	6	7	8
Temperatura colore	2700K	3000K	4200K	6000K	Blue	Green	Red
Température couleur					Bleu	Vert	Rouge
Temperaturabhängige Farbe					Blau	Grün	Rot
Temperatura de color					Azul		Rojo

Finishing	2	5	6
Finitura	Aluminium	Black	Bronze
Finitions	Aluminium	Nero	Bronzo
Oberflächenfinish	Aluminium	Noir	Bronce
Acabados	Aluminio	Schwarz	Bronce
		Negro	

Accessories

Accessori - Accessoires
Zubehör - Accesorios

XP0011

Earth spike
Picchetto
Piquet de terre
Erdspeiß
Pico de la tierra

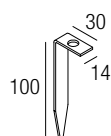

XP0200

Aluminium
Aluminium
Aluminium
Aluminio

XP0500

Black
Nero
Noir
Schwarz
Negro

XP0600

Bronze
Bronzo
Bronce

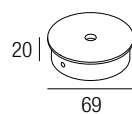

Base
Basis

XNTZ102

Aluminium
Aluminium
Aluminium
Aluminio

XNTZ105

Black
Nero
Noir
Schwarz
Negro

XNTZ106

Bronze
Bronzo
Bronce

Antiglare snoot

Snoot antiabbagliamento
Snoot antiéblouissement
Blendschutz Snoot
Snoot antideslumbrante



XXT01

Tree strap
Cinghia per albero
Courroie d'arbre
Baumbügel
Correa del árbol

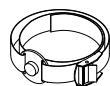

Drivers

Alimentatori - Alimentateurs
Netzteile - Alimentadores

350 mA	on/off	dimmable	500 mA	on/off	dimmable
	AL1034 (1..11) 30mm IP20	AL4000 (1..12) 72mm IP20 PUSH 0/1..10V		AL1074 (1..7) 30mm IP20	AL4010 (1..12) 72mm IP20 PUSH 0/1..10V
	AL1035 (1..11) 40mm IP20	AL4051 (2..14) 72mm IP20 DALI 2		AL1077 (1..6) 40mm IP20	AL4151 (2..14) 72mm IP20 DALI 2
	AL1037 (1..16) 50mm IP20 S.P.	AL4053 (1..14) 50mm IP20 PUSH IGBT-TRIAC		AL1084 (1..11) 55mm IP20 S.P.	AL4153 (1..14) 56mm IP20 PUSH IGBT-TRIAC
	AL9011 (1..12) 44mm IP67	AL8035 (4..16) IP67 DALI		AL9051 (1..11) 44mm IP67	AL8050 (4..16) IP67 DALI

Note: cable cut to measure on request

Nota: cavo a misura disponibile su richiesta

Note: câble sur mesure disponible sur demande

Anmerkung: kundenspezifisches Kabel auf Anfrage erhältlich

Nota: cable a medida disponible a petición



ZOOM 10

design: Lapo Grassellini

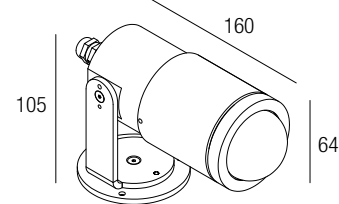

Supply current

Alimentazione
Courant d'alimentation
Stromversorgung
Corriente de alimentación
230 VAC

Power

Potenza
Puissance
Bestuekung
Potencia
10 W



CCT/CRI/Flux

2700K — **890 lm**
3000K — **1000 lm**
4000K — **1040 lm**

Adjustable optics

Ottica variabile
Optique réglable
Einstellbarer Optik
Óptica ajustable

10-55°

CRI85

2-Step MacAdam

Code Construction

Costruzione del codice - Construction du code produit
Bau der Produkt-Code - Construcción del código de producto

ZM2 X X

Color

Temperature

	2	3	4
Temperatura colore	2700K	3000K	4000K
Température couleur			
Temperaturabhängige Farbe			
Temperatura de color			

Finishing

	2	5	6
Finitura	Aluminium	Black	Bronze
Finitions	Alluminio	Nero	Bronzo
Oberflächenfinish	Aluminium	Noir	Bronce
Acabados	Aluminio	Schwarz	Negro

Accessories

Accessori - Accessoires
Zubehör - Accesorios

ESZM201

Earth spike
Picchetto
Piquet de terre
Erdspeiß
Pico de la tierra

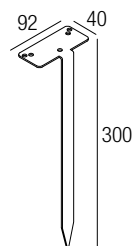

XNTZ202

Aluminium
Aluminio
Aluminium
Aluminio

XNTZ205

Black
Nero
Noir
Schwarz
Negro

XNTZ206

Bronze
Bronzo
Bronce

Antiglare snoot

Snoot antiabbagliamento
Snoot antiéblouissement
Blendschutz Snoot
Snoot antideslumbrante

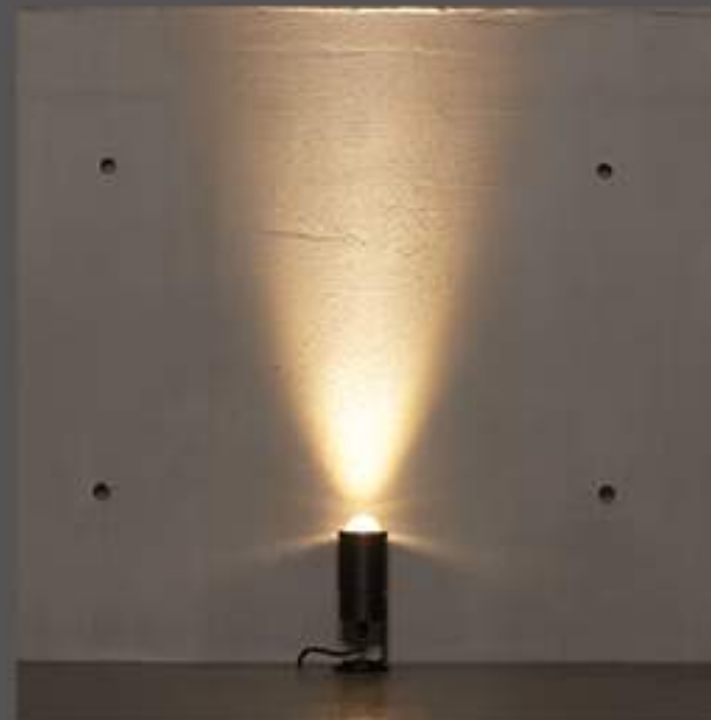
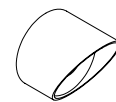

CLIO 10

design: Lapo Grassellini

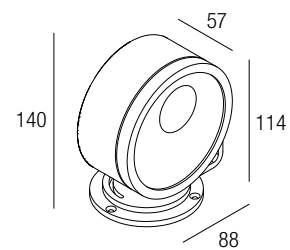

Supply current
 Alimentazione
 Courant d'alimentation
 Stromversorgung
 Corriente de alimentación
230 VAC

Power
 Potenza
 Pouissance
 Bestuekung
 Potencia
10 W



CCT/CRI/Flux

	CRI85	CRI93
2700K	890 lm	840 lm
3000K	1000 lm	930 lm
4000K	1040 lm	960 lm

Photometric diagrams

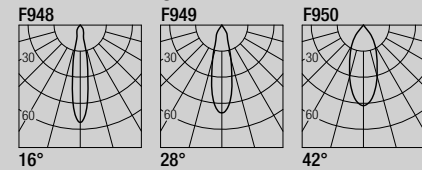

CRI85 - CRI93
2-Step MacAdam

Code Construction

Costruzione del codice - Construction du code produit
 Bau der Produkt-Code - Construcción del código de producto

CP1 X X X X

	S	M	W
Beam angle Apertura di fascio Angle de faisceau Strahlwinkel Angulo del haz	16°	28°	42°
CRI	85	93	
Color Temperature Temperatura colore Température couleur Temperaturabhängige Farbe Temperatura de color	2700K	3000K	4000K
Finishing Finitura Finitions Oberflächenfinish Acabados	2 Aluminium Alluminio Aluminio	5 Black Nero Noir Schwarz Negro	6 Bronze Bronzo Bronce

Accessories

Accessori - Accessoires
 Zubehör - Accesorios

ESCP101

Earth spike
 Picchetto
 Piquet de terre
 Erdspieß
 Pico de la tierra

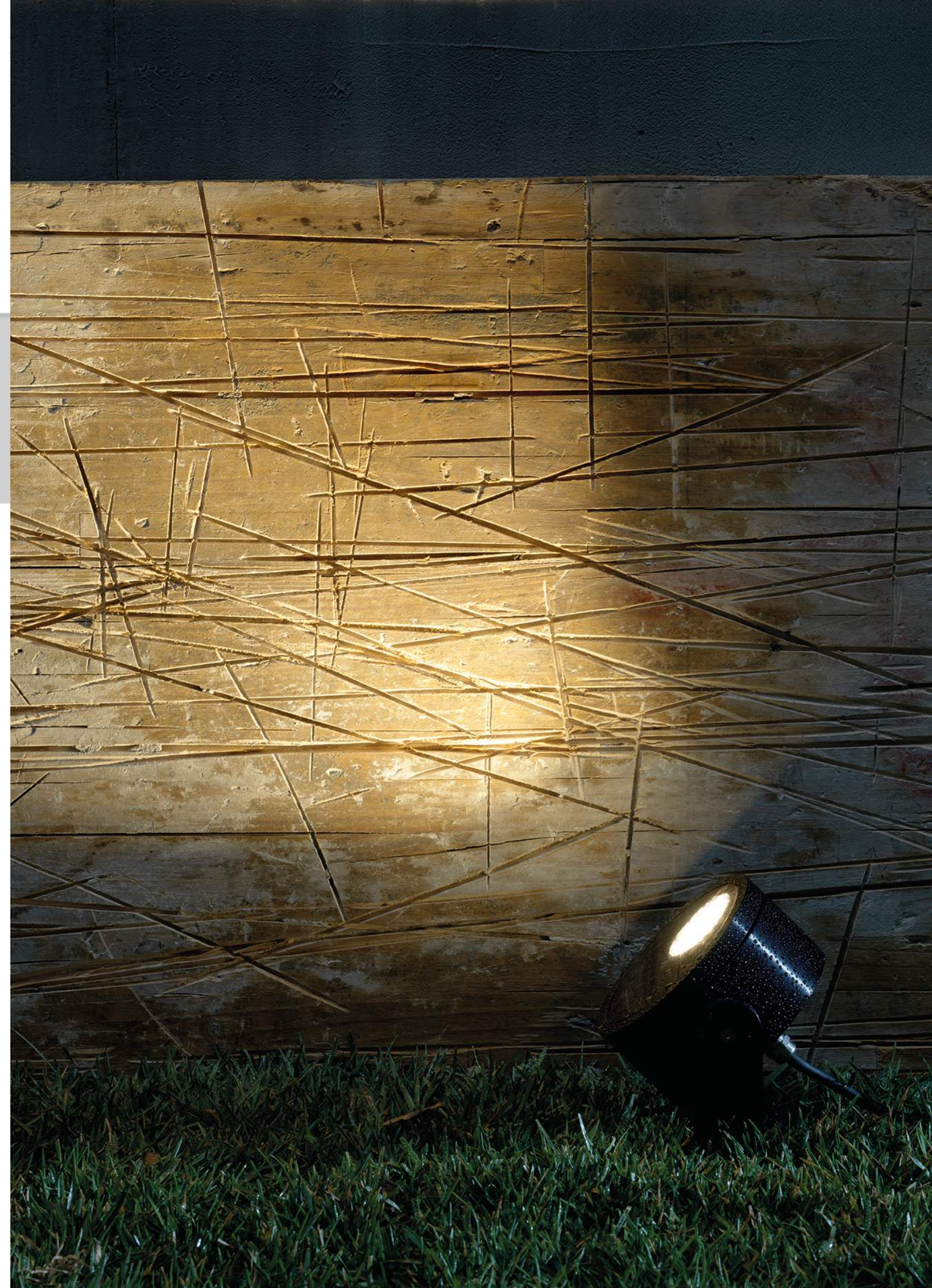
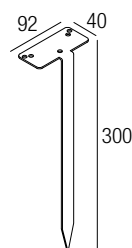

CLIO 20

design: Lapo Grassellini

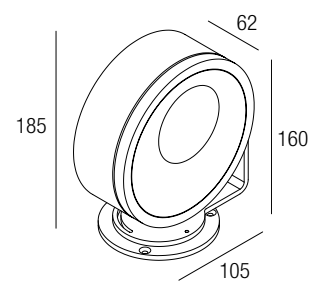

Supply current
 Alimentazione
 Courant d'alimentation
 Stromversorgung
 Corriente de alimentación
230 VAC

Power
 Potenza
 Pouissance
 Bestuekung
 Potencia
20 W

- DATASHEET ▶
- INSTALLATION MANUAL ▶
- CERTIFICATIONS ▶
- LDT-IES ▶
- DRAWINGS ▶



Photometric diagrams

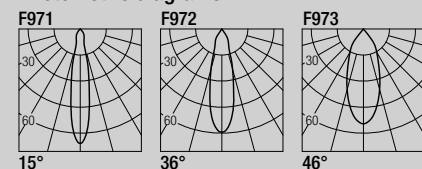

CCT/CRI/Flux	CRI85	CRI93
2700K	1830 lm	1700 lm
3000K	2000 lm	1830 lm
4000K	2100 lm	1950 lm

CRI85 - CRI93
2-Step MacAdam

Code Construction

Costruzione del codice - Construction du code produit
 Bau der Produkt-Code - Construcción del código de producto

CP2 X X X X

Beam angle	S	M	W
Apertura di fascio Angle de faisceau Strahlwinkel Ángulo del haz	15°	36°	46°
CRI	85	93	
Color Temperature	2	3	4
Temperatura colore Température couleur Temperaturabhängige Farbe Temperatura de color	2700K	3000K	4000K
Finishing	2	5	6
Finitura Finitions Oberflächenfinish Acabados	Aluminium Aluminio Aluminio	Black Nero Noir Schwarz Negro	Bronze Bronzo Bronce

Accessories

Accessori - Accessoires
 Zubehör - Accesorios

ESCP201

Earth spike
 Picchetto
 Piquet de terre
 Erdspließ
 Pico de la tierra

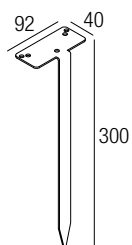

POLE

The Pole system allows multiple luminaires to be distributed along the vertical support. Available in four heights, the luminaires installed can be directed to any direction, offering a flexible and dynamic installation solution.

Il sistema Pole consente l'impiego di numerosi apparecchi luminosi da distribuire sul supporto verticale. Disponibile in quattro altezze, consente di direzionare gli apparecchi installati verso qualsiasi direzione, offrendo una soluzione installativa flessibile e dinamica.

Le système Pole permet d'utiliser de nombreux appareils à répartir sur le support vertical. Disponible en quatre hauteurs, il permet de diriger les appareils installés en toute direction, en offrant une solution d'installation flexible et dynamique.

Das Pole-System ermöglicht den Einsatz zahlreicher Leuchten, die auf dem vertikalen Träger verteilt werden können. Es ist in vier Höhen erhältlich und ermöglicht es, die installierten Leuchten in jede Richtung zu lenken, was eine flexible und dynamische Installationslösung bietet.

El sistema Pole permite la utilización de numerosos aparatos luminosos que se distribuyen en el soporte vertical. Disponible en cuatro alturas, permite orientar los aparatos instaladas en cualquier dirección, ofreciendo una solución de instalación flexible y dinámica.

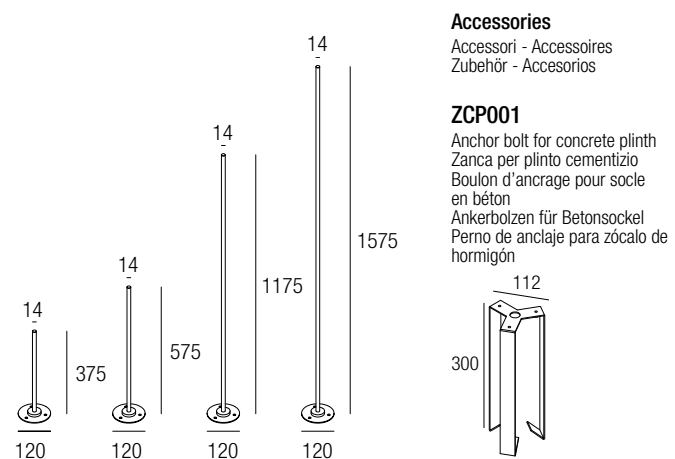

Code Construction

Costruzione del codice - Construction du code produit
 Bau der Produkt-Code - Construcción del código de producto

PL X X

Finishing	1	5	9
Finitura	White	Black	COR-TEN
Finitions	Bianco	Nero	
Oberflächenfinish	Blanc	Noir	
Acabados	Weiß	Schwarz	
	Blanco	Negro	

Height	A	B	C	D
Altezza	37,5 cm	57,5 cm	117,5 cm	157,5 cm
Hauteur				
Höhe				
Altura				



OLU 6 POLE

design: Roberto Mantovani

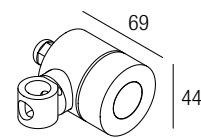

Supply current
Alimentazione
Courant d'alimentation
Stromversorgung
Corriente de alimentación
350-500 mA (V, 8,7V)

Power
Potenza
Puissance
Bestuekung
Potencia
3-6 W

Series wiring
Cablaggio in serie
Câblage en série
Verkabelung in Serie
Cableado en serie



Photometric diagrams

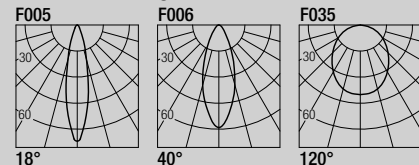

CCT/CRI/Flux	350mA		500mA	
	2700K	267 lm	384 lm	
3000K	279 lm	400 lm		
4200K	309 lm	462 lm		
6000K	342 lm	495 lm		

CRI85
2-Step MacAdam



MAHALO POLE

design: Roberto Mantovani

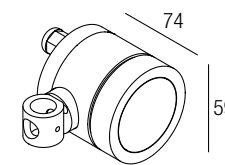

Supply current
Alimentazione
Courant d'alimentation
Stromversorgung
Corriente de alimentación
24 VDC

Power
Potenza
Puissance
Bestuekung
Potencia
7 W

Parallel wiring
Cablaggio in parallelo
Câblage en parallèle
Verkabelung in parallel
Cableado en paralelo



Photometric diagrams

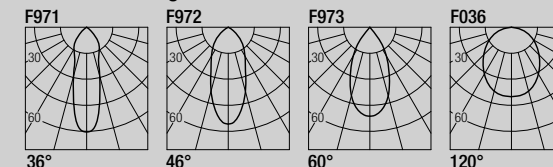

CCT/CRI/Flux	CRI85		CRI93	
	2700K	630 lm	590 lm	
3000K	700 lm	650 lm		
4000K	730 lm	670 lm		

CRI85 - CRI93
2-Step MacAdam



Code Construction

Costruzione del codice - Construction du code produit
Bau der Produkt-Code - Construcción del código de producto

LUP2 X X X X

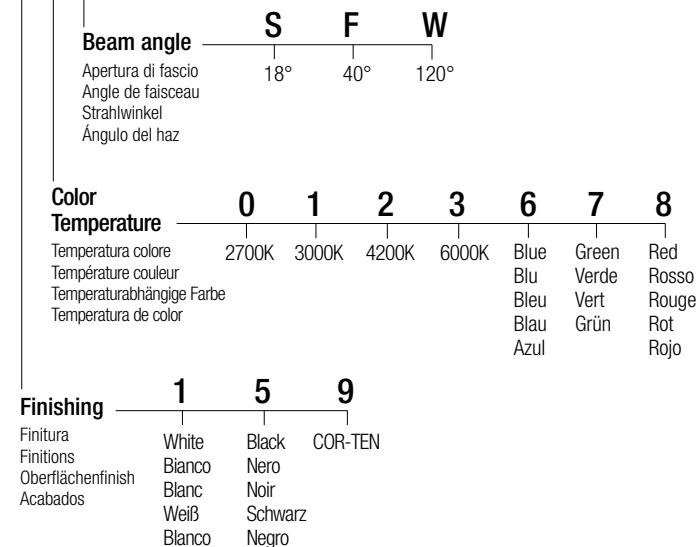

Note: cable cut to measure on request
Nota: cavo a misura disponibile su richiesta
Note: câble sur mesure disponible sur demande
Anmerkung: kundenspezifisches Kabel auf Anfrage erhältlich
Nota: cable a medida disponible a petición

Accessories

Accessori - Accessoires
Zubehör - Accesorios

XNTC01V XNTC05V XNTC09V

White Bianco Weiß Blanco Black Nero Noir Schwarz Negro COR-TEN

Antiglare snoot
Snoot antiabbagliamento
Snoot antiéblouissement
Blendschutz Snoot
Snoot antideslumbrante



Drivers

Alimentatori - Alimentateurs
Netzteile - Alimentadores

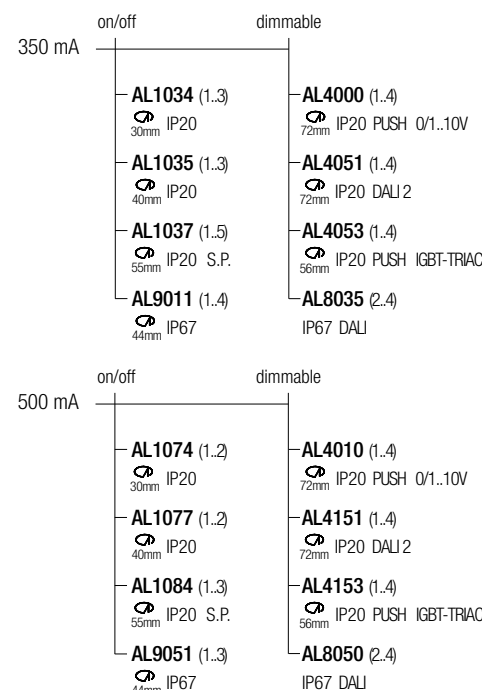

Code Construction

Costruzione del codice - Construction du code produit
Bau der Produkt-Code - Construcción del código de producto

MHP1 X X X X

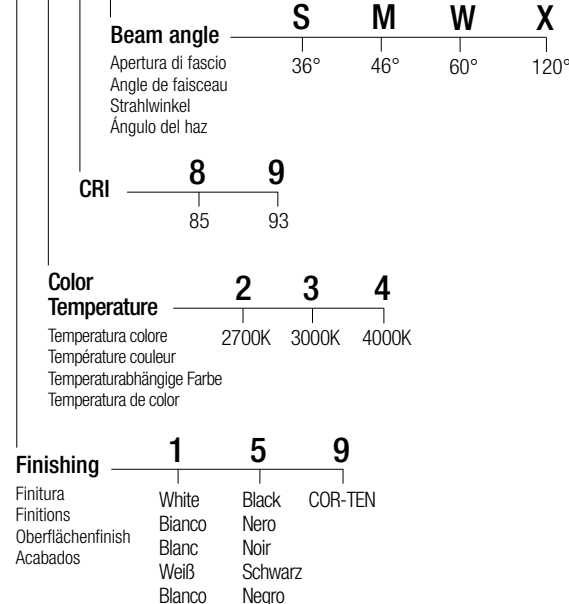

Note: cable cut to measure on request
Nota: cavo a misura disponibile su richiesta
Note: câble sur mesure disponible sur demande
Anmerkung: kundenspezifisches Kabel auf Anfrage erhältlich
Nota: cable a medida disponible a petición

Accessories

Accessori - Accessoires
Zubehör - Accesorios

LMHP101

Low luminance louver
Filtro antiabbagliamento
Filtre basse luminance
Geringe Leuchtdichte-Filter
Filtro de baja luminancia



Note: the filter must be ordered together with the lighting fixture - **Nota:** il filtro deve essere ordinato congiuntamente all'apparecchio - **Note:** le filtre doit être commandé en même temps que l'appareil - **Anmerkung:** muss der Filter zusammen mit Leuchtkörper bestellt werden
Nota: el filtro debe pedirse junto con la luminaria

XNTX201V XNTX205V XNTX209V

White Bianco Weiß Blanco Black Nero Noir Schwarz Negro COR-TEN

Antiglare snoot
Snoot antiabbagliamento
Snoot antiéblouissement
Blendschutz Snoot
Snoot antideslumbrante



Drivers

Alimentatori - Alimentateurs
Netzteile - Alimentadores

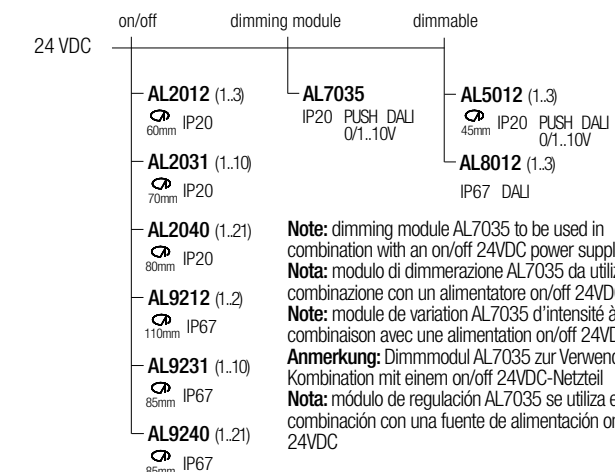

ELLE 2

design: Roberto Mantovani

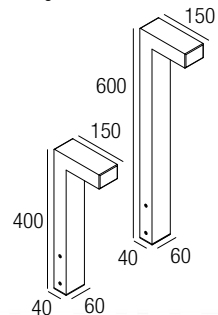

Supply current

Alimentazione
Courant d'alimentation
Stromversorgung
Corriente de alimentación

350-500 mA (V_i 2,9V)

Power

Potenza
Puissance
Bestuekung
Potencia

1-2 W

Series wiring

Cablaggio in serie
Câblage en série
Verkabelung in Serie
Cableado en serie

[DATASHEET](#) ▶ [INSTALLATION MANUAL](#) ▶
[CERTIFICATIONS](#) ▶ [LDT-IES](#) ▶ [DRAWINGS](#) ▶



Photometric diagrams

F003

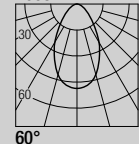

CCT/CRI/Flux

	350mA	500mA
2700K	89 lm	128 lm
3000K	93 lm	133 lm
4200K	103 lm	154 lm
6000K	114 lm	165 lm

CRI85

2-Step MacAdam

Code Construction

Costruzione del codice - Construction du code produit
Bau der Produkt-Code - Construcción del código de producto

BLS X X X

Color Temperature	20	21	22	23	26	27	28
Temperatura colore	2700K	3000K	4200K	6000K	Blue	Green	Red
Température couleur					Blu	Verde	Rosso
Temperaturabhängige Farbe					Bleu	Vert	Rouge
Temperatura de color					Blau	Grün	Rot
					Azul		Rojo

Finishing	1	2	5	9
Finitura	White	Grey	Black	COR-TEN
Finitions	Bianco	Grigio	Nero	
Oberflächenfinish	Blanc	Gris	Noir	
Acabados	Weiß	Grau	Schwarz	
	Blanco		Negro	

Height	4	6
Altezza	40cm	60cm
Hauteur		
Höhe		
Altura		

Accessories

Accessori - Accessoires
Zubehör - Accesorios

ZC001

Anchor bolt for concrete plinth
Zanca per plinto cementizio
Boulon d'ancrage pour socle en béton
Ankerbolzen für Betonsoclel
Perno de anclaje para zócalo de hormigón

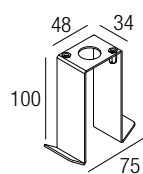

Note: cable cut to measure on request
Nota: cavo a misura disponibile su richiesta
Note: câble sur mesure disponible sur demande
Anmerkung: kundenspezifisches Kabel auf Anfrage erhältlich
Nota: cable a medida disponible a petición

Drivers

Alimentatori - Alimentateurs
Netzteile - Alimentadores

350 mA		500 mA	
on/off	dimmable	on/off	dimmable
AL1034 (1..11) 30mm IP20	AL4000 (1..12) 72mm IP20 PUSH 0/1..10V	AL1074 (1..7) 30mm IP20	AL4010 (1..12) 72mm IP20 PUSH 0/1..10V
AL1035 (1..11) 40mm IP20	AL4051 (2..14) 72mm IP20 DALI 2	AL1077 (1..6) 40mm IP20	AL4151 (2..14) 72mm IP20 DALI 2
AL1037 (1..16) 55mm IP20 S.P.	AL4053 (1..14) 56mm IP20 PUSH IGBT-TRIAC	AL1084 (1..11) 55mm IP20 S.P.	AL4153 (1..14) 56mm IP20 PUSH IGBT-TRIAC
AL9011 (1..12) 44mm IP67	AL8035 (4..16) IP67 DALI	AL9051 (1..11) 44mm IP67	AL8050 (4..16) IP67 DALI



ELLE 6

design: Roberto Mantovani

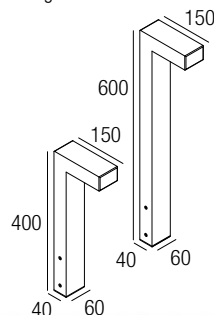

Supply current

Alimentazione
Courant d'alimentation
Stromversorgung
Corriente de alimentación

350-500 mA (V_i 8,7V)

Power

Potenza
Puissance
Bestuekung
Potencia

3-6 W

Series wiring

Cablaggio in serie
Câblage en série
Verkabelung in Serie
Cableado en serie

- [DATASHEET ▶](#)
- [INSTALLATION MANUAL ▶](#)
- [CERTIFICATIONS ▶](#)
- [LDT-IES ▶](#)
- [DRAWINGS ▶](#)



CCT/CRI/Flux

	350mA	500mA
2700K	267 lm	384 lm
3000K	279 lm	400 lm
4200K	309 lm	462 lm
6000K	342 lm	495 lm

Photometric diagrams

F006

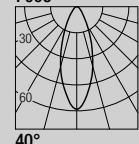

CRI85

2-Step MacAdam

Code Construction

Costruzione del codice - Construction du code produit
Bau der Produkt-Code - Construcción del código de producto

BLP X X X

Color	20	21	22	23	26	27	28
Temperature	2700K	3000K	4200K	6000K	Blue	Green	Red
Temperatura colore					Blu	Verde	Rosso
Température couleur					Bleu	Vert	Rouge
Temperaturabhängige Farbe					Blau	Grün	Rot
Temperatura de color					Azul		Rojo

Finishing	1	2	5	9
Finitura	White	Grey	Black	COR-TEN
Finitions	Bianco	Grigio	Nero	
Oberflächenfinish	Blanc	Gris	Noir	
Acabados	Weiß	Grau	Schwarz	
	Blanco		Negro	

Height	4	6
Altezza	40cm	60cm
Hauteur		
Höhe		
Altura		

Accessories

Accessori - Accessoires
Zubehör - Accesorios

ZC001

Anchor bolt for concrete plinth
Zanca per plinto cementizio
Boulon d'ancrage pour socle en béton
Ankerbolzen für Betonsockel
Perno de anclaje para zócalo de hormigón

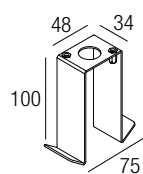

Note: cable cut to measure on request
Nota: cavo a misura disponibile su richiesta
Note: câble sur mesure disponible sur demande
Anmerkung: kundenspezifisches Kabel auf Anfrage erhältlich
Nota: cable a medida disponible a petición

Drivers

Alimentatori - Alimentateurs
Netzteile - Alimentadores

350 mA		500 mA	
on/off	dimnable	on/off	dimnable
AL1034 (1..3) 30mm IP20	AL4000 (1..4) 72mm IP20 PUSH 0/1..10V	AL1074 (1..2) 30mm IP20	AL4010 (1..4) 72mm IP20 PUSH 0/1..10V
AL1035 (1..3) 40mm IP20	AL4051 (1..4) 72mm IP20 DALI 2	AL1077 (1..2) 40mm IP20	AL4151 (1..4) 72mm IP20 DALI 2
AL1037 (1..3) 55mm IP20 S.P.	AL4053 (1..4) 96mm IP20 PUSH IGBT-TRIAC	AL1084 (1..3) 55mm IP20 S.P.	AL4153 (1..4) 56mm IP20 PUSH IGBT-TRIAC
AL9011 (1..4) 44mm IP67	AL8035 (2..4) IP67 DALI	AL9051 (1..3) 44mm IP67	AL8050 (2..4) IP67 DALI

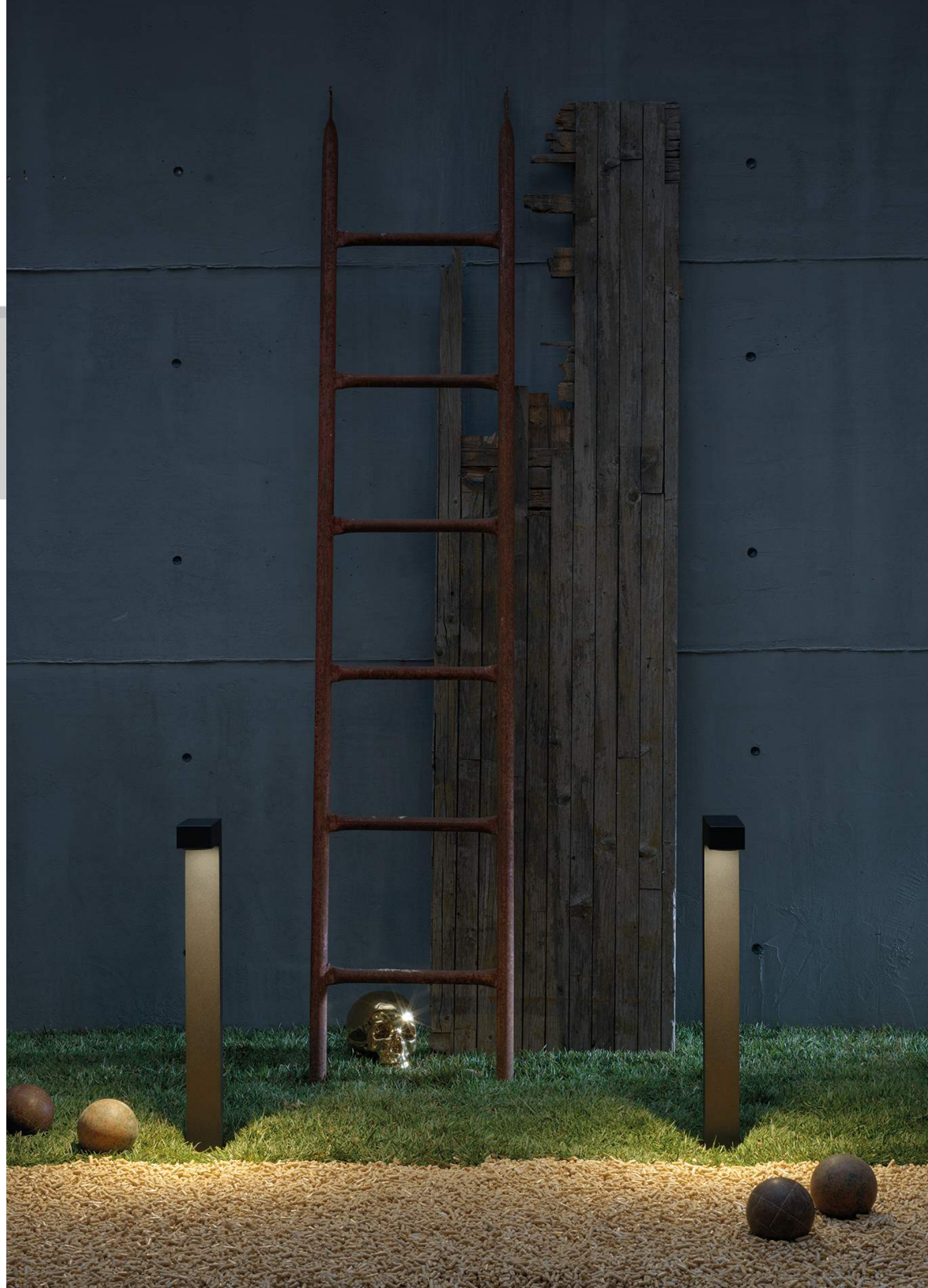

SIGN

design: Lapo Grassellini

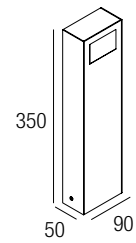

Supply current

Alimentazione
Courant d'alimentation
Stromversorgung
Corriente de alimentación

230 VAC

Power

Potenza
Puissance
Bestuekung
Potencia

5 W



CCT/CRI/Flux

Photometric diagrams

F007



ASYMMETRIC

2700K — 324 lm
3000K — 360 lm
4200K — 385 lm

CRI85
2-Step MacAdam

Code Construction

Costruzione del codice - Construction du code produit
Bau der Produkt-Code - Construcción del código de producto

SG1 X X

Finishing	B	G	N	K
Finitura	White	Grey	Black	COR-TEN
Finitions	Bianco	Grigio	Nero	
Oberflächenfinish	Blanc	Gris	Noir	
Acabados	Weiß	Grau	Schwarz	
	Blanco		Negro	

Color Temperature	2	3	4
Temperatura colore	2700K	3000K	4000K
Température couleur			
Temperaturabhängige Farbe			
Temperatura de color			



DIDO

design: Lapo Grassellini

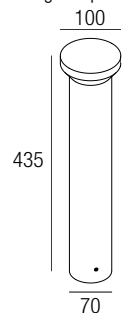

Supply current

Alimentazione
Courant d'alimentation
Stromversorgung
Corriente de alimentación

24 VDC

Power

Potenza
Puissance
Bestuekung
Potencia

8,2 W

Parallel wiring

Cablaggio in parallelo
Câblage en parallèle
Verkabelung in parallel
Cableado en paralelo

[DATASHEET](#) [INSTALLATION MANUAL](#)

[CERTIFICATIONS](#) [LDT-IES](#) [DRAWINGS](#)



IP65 CCT/CRI/Flux

2700K — 540 lm
3000K — 560 lm
4000K — 610 lm

CRI85

2-Step MacAdam

Code Construction

Costruzione del codice - Construction du code produit
Bau der Produkt-Code - Construcción del código de producto

DD4 X X

Color Temperature	20	21	22
Temperatura colore	2700K	3000K	4000K
Température couleur			
Temperaturabhängige Farbe			
Temperatura de color			

Finishing	1	2	5	9
Finitura	White	Grey	Black	COR-TEN
Finitions	Bianco	Grigio	Nero	
Oberflächenfinish	Blanc	Gris	Noir	
Acabados	Weiß	Grau	Schwarz	
	Blanco		Negro	

Note: cable cut to measure on request

Nota: cavo a misura disponibile su richiesta

Note: câble sur mesure disponible sur demande

Anmerkung: kundenspezifisches Kabel auf Anfrage erhältlich

Nota: cable a medida disponible a petición

Drivers

Alimentatori - Alimentateurs
Netzteile - Alimentadores

24 VDC	on/off	dimnable	dimming module
AL2012 (1..3)	60mm IP20	AL5012 (1..2)	AL7035
AL2031 (1..8)	70mm IP20	45mm IP20 PUSH DALI 0/1..10V	IP20 PUSH DALI 0/1..10V
AL2040 (1..18)	80mm IP20	AL8012 (1..2)	
AL9212 (1..2)	110mm IP67	IP67 DALI	
AL9231 (1..8)	85mm IP67		
AL9240 (1..18)	85mm IP67		

Note: dimming module AL7035 to be used in combination with an on/off 24VDC power supply
Nota: modulo di dimmerazione AL7035 da utilizzare in combinazione con un alimentatore on/off 24VDC
Note: module de variation AL7035 d'intensité à utiliser en combinaison avec une alimentation on/off 24VDC
Anmerkung: Dimmmodul AL7035 zur Verwendung in Kombination mit einem on/off 24VDC-Netzteil
Nota: módulo de regulación AL7035 se utiliza en combinación con una fuente de alimentación on/off 24VDC



DUSK

design: Roberto Mantovani

[DATASHEET ▶](#) [INSTALLATION MANUAL ▶](#)

[CERTIFICATIONS ▶](#) [LDT-IES ▶](#) [DRAWINGS ▶](#)

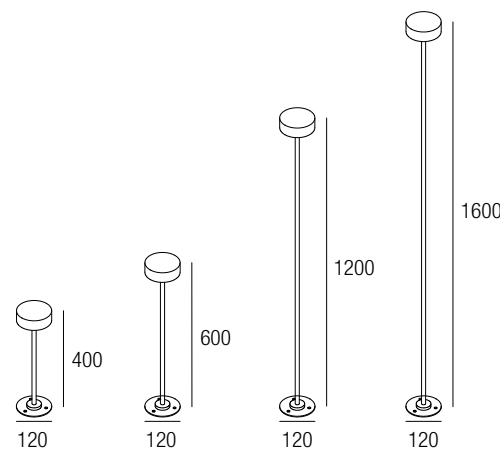

Supply current

Alimentazione
 Courant d'alimentation
 Stromversorgung
 Corriente de alimentación
24 VDC

Power

Potenza
 Pouissance
 Bestuekung
 Potencia
8,2 W

Parallel wiring

Cablaggio in parallelo
 Câblage en parallèle
 Verkabelung in parallel
 Cableado en paralelo



CCT/CRI/Flux

2700K — **540 lm**
 3000K — **560 lm**
 4000K — **610 lm**

CRI85

2-Step MacAdam

Code Construction

Costruzione del codice - Construction du code produit
 Bau der Produkt-Code - Construcción del código de producto

DU X X X

Color Temperature — **2 3 4**
 2700K 3000K 4000K
 Temperatura colore
 Température couleur
 Temperaturabhängige Farbe
 Temperatura de color

Finishing — **1 5 9**
 1: White, 5: Black, 9: COR-TEN
 Finitura: Bianco, Nero, COR-TEN
 Finitions: Blanc, Noir
 Oberflächenfinish: Weiß, Schwarz
 Acabados: Blanco, Negro

Height — **A B C D**
 40cm 60cm 120cm 160cm
 Altezza
 Hauteur
 Höhe
 Altura

Accessories

Accessori - Accessoires
 Zubehör - Accesorios

ZCP001

Anchor bolt for concrete plinth
 Zanca per plinto cementizio
 Boulon d'ancrage pour socle en béton
 Ankerbolzen für Betonsoclel
 Perno de anclaje para zócalo de hormigón

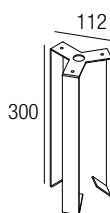

Note: cable cut to measure on request
Nota: cavo a misura disponibile su richiesta
Note: câble sur mesure disponible sur demande
Anmerkung: kundenspezifisches Kabel auf Anfrage erhältlich
Nota: cable a medida disponible a petición

Drivers

Alimentatori - Alimentateurs
 Netzteile - Alimentadores

24 VDC	on/off	dimmable	dimming module
AL2012 (1..3)	60mm IP20	AL5012 (1..2)	AL7035
AL2031 (1..8)	70mm IP20	AL8012 (1..2)	IP20 PUSH DALI 0/1..10V
AL2040 (1..18)	80mm IP20		IP20 PUSH DALI 0/1..10V
AL9212 (1..2)	110mm IP67		
AL9231 (1..8)	85mm IP67		
AL9240 (1..18)	85mm IP67		

Note: dimming module AL7035 to be used in combination with an on/off 24VDC power supply
Nota: modulo di dimmerazione AL7035 da utilizzare in combinazione con un alimentatore on/off 24VDC
Note: module de variation AL7035 d'intensité à utiliser en combinaison avec une alimentation on/off 24VDC
Anmerkung: Dimmmodul AL7035 zur Verwendung in Kombination mit einem on/off 24VDC-Netzteil
Nota: módulo de regulación AL7035 se utiliza en combinación con una fuente de alimentación on/off 24VDC



COLOR

design: Roberto Mantovani

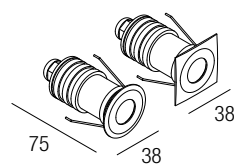

Supply current

Alimentazione
Courant d'alimentation
Stromversorgung
Corriente de alimentación
3 x 350 mA

Power

Potenza
Puissance
Bestuekung
Potencia
3 x 1W

Series wiring

Cablaggio in serie
Câblage en série
Verkabelung in Serie
Cableado en serie



Photometric diagrams

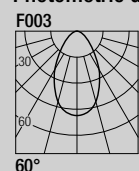

Code Construction

Costruzione del codice - Construction du code produit
Bau der Produkt-Code - Construcción del código de producto

FC X X 2 9

Finishing	1	2	3	4	5	6	7	9
Finitura Finitions Oberflächenfinish Acabados	White Bianco Blanc Weiß Blanco	Aluminium Aluminio Aluminium Aluminio	Chrome Cromo Chrom	Gold Oro Or	Black Nero Noir Schwarz Negro	Bronze Bronzo Bronce	Titanium Titanio Titane Titan	INOX AISI 316L Steel Acciaio Acier Stahl Acero
Shape	1	2						
Forma Forme Form	Round Tondo Ronde Runde Redondo	Square Quadro Carré Quadrat Cuadrado						

Drivers

Alimentatori - Alimentateurs
Netzteile - Alimentadores

Note: for a correct installation it is necessary to order all the codes
Nota: per installare correttamente il sistema è necessario ordinare tutti i codici
Note: pour installer le système correctement, il est nécessaire de commander tous les codes
Anmerkung: um das System korrekt zu installieren, müssen Sie alle Codes bestellen
Nota: para instalar el sistema correctamente es necesario ordenar todos los códigos

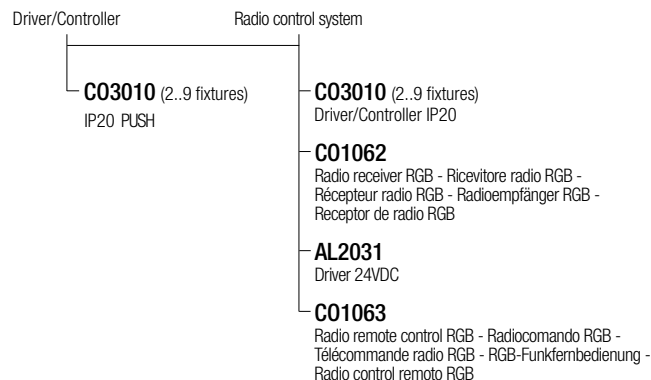

SINTRA

design: Roberto Mantovani

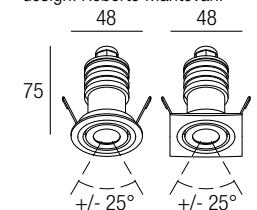

Supply current

Alimentazione
Courant d'alimentation
Stromversorgung
Corriente de alimentación
3 x 350 mA

Power

Potenza
Puissance
Bestuekung
Potencia
3 x 1W

Series wiring

Cablaggio in serie
Câblage en série
Verkabelung in Serie
Cableado en serie



Photometric diagrams

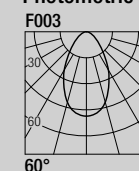

Code Construction

Costruzione del codice - Construction du code produit
Bau der Produkt-Code - Construcción del código de producto

JC X X 2 9

Finishing	1	2	3	4	5	6	7
Finitura Finitions Oberflächenfinish Acabados	White Bianco Blanc Weiß Blanco	Aluminium Aluminio Aluminium Aluminio	Chrome Cromo Chrom	Gold Oro Or	Black Nero Noir Schwarz Negro	Bronze Bronzo Bronce	Titanium Titanio Titane Titan
Shape	1	2					
Forma Forme Form	Round Tondo Ronde Runde Redondo	Square Quadro Carré Quadrat Cuadrado					

Drivers

Alimentatori - Alimentateurs
Netzteile - Alimentadores

Note: for a correct installation it is necessary to order all the codes
Nota: per installare correttamente il sistema è necessario ordinare tutti i codici
Note: pour installer le système correctement, il est nécessaire de commander tous les codes
Anmerkung: um das System korrekt zu installieren, müssen Sie alle Codes bestellen
Nota: para instalar el sistema correctamente es necesario ordenar todos los códigos

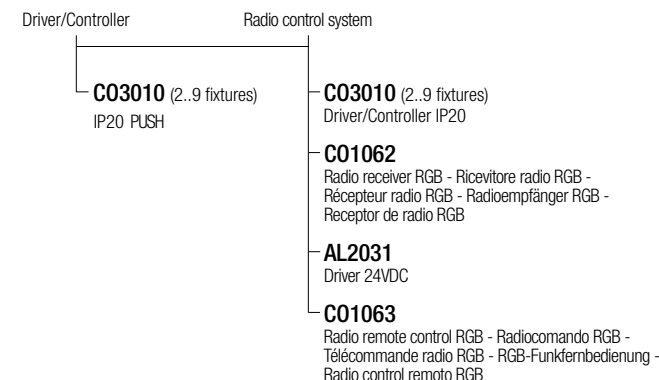

Accessories

Accessori - Accessoires
Zubehör - Accesorios

CS1006

Recessing box
Controcassa
Boîtier d'encastrement
Eingieβgehäuse
Caja de empotrar

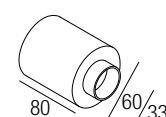

Accessories

Accessori - Accessoires
Zubehör - Accesorios

CS1005

Recessing box
Controcassa
Boîtier d'encastrement
Eingieβgehäuse
Caja de empotrar

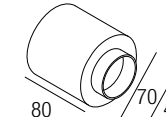

ZERO R RGB

design: Roberto Mantovani

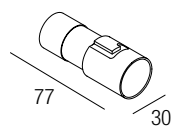
**Supply current**

Alimentazione
Courant d'alimentation
Stromversorgung
Corriente de alimentación

3 x 350 mA**Power**

Potenza
Puissance
Bestuekung
Potencia

3 x 1W**Series wiring**

Cablaggio in serie
Câblage en série
Verkabelung in Serie
Cableado en serie

**Photometric diagrams**

F003

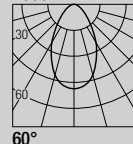
**Code Construction**

Costruzione del codice - Construction du code produit
Bau der Produkt-Code - Construcción del código de producto

ZC1 X 2 9**Finishing**

Finitura
Finitions
Oberflächenfinish
Acabados

1White
Bianco
Blanc
Weiß
Blanco**5**

Black
Nero
Noir
Schwarz
Negro

Accessories

Accessori - Accessoires
Zubehör - Accesorios

ZQC001 ZQC001B

White Black
Bianco Nero
Blanc Noir
Weiß Schwarz
Blanco Negro

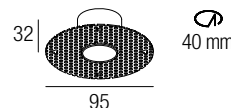

Plasterboard recessing frame
Flangia per cartongesso
Boîtier d'encastrement pour plaques de plâtre
Gehäuses Trockenbau
Cajetin para placas de yeso

Drivers

Alimentatori - Alimentateurs
Netzteile - Alimentadores

Note: for a correct installation it is necessary to order all the codes**Nota:** per installare correttamente il sistema è necessario ordinare tutti i codici**Note:** pour installer le système correctement, il est nécessaire de commander tous les codes**Anmerkung:** um das System korrekt zu installieren, müssen Sie alle Codes bestellen**Nota:** para instalar el sistema correctamente es necesario ordenar todos los códigos

Driver/Controller Radio control system

C03010 (2..9 fixtures)
IP20 PUSH

C03010 (2..9 fixtures)
Driver/Controller IP20

C01062

Radio receiver RGB - Ricevitore radio RGB -
Récepteur radio RGB - Radioempfänger RGB -
Receptor de radio RGB

AL2031

Driver 24VDC

C01063

Radio remote control RGB - Radiocomando RGB -
Télécommande radio RGB - RGB-Funkfernbedienung -
Radio control remoto RGB

ZERO Q RGB

design: Roberto Mantovani

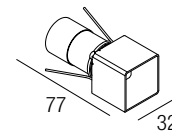
**Supply current**

Alimentazione
Courant d'alimentation
Stromversorgung
Corriente de alimentación

3 x 350 mA**Power**

Potenza
Puissance
Bestuekung
Potencia

3 x 1W**Series wiring**

Cablaggio in serie
Câblage en série
Verkabelung in Serie
Cableado en serie

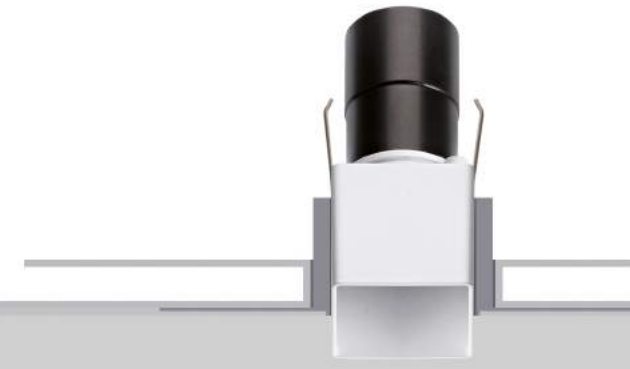
**Photometric diagrams**

F003

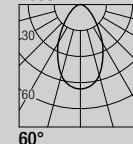
**Code Construction**

Costruzione del codice - Construction du code produit
Bau der Produkt-Code - Construcción del código de producto

ZC2 X 2 9**Finishing**

Finitura
Finitions
Oberflächenfinish
Acabados

1

White
Bianco
Blanc
Weiß
Blanco

5

Black
Nero
Noir
Schwarz
Negro

Accessories

Accessori - Accessoires
Zubehör - Accesorios

ZQC002 ZQC002B

White Black
Bianco Nero
Blanc Noir
Weiß Schwarz
Blanco Negro

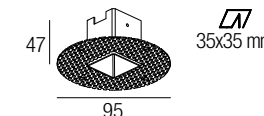

Plasterboard recessing frame
Flangia per cartongesso
Boîtier d'encastrement pour plaques de plâtre
Gehäuses Trockenbau
Cajetin para placas de yeso

Drivers

Alimentatori - Alimentateurs
Netzteile - Alimentadores

Note: for a correct installation it is necessary to order all the codes**Nota:** per installare correttamente il sistema è necessario ordinare tutti i codici**Note:** pour installer le système correctement, il est nécessaire de commander tous les codes**Anmerkung:** um das System korrekt zu installieren, müssen Sie alle Codes bestellen**Nota:** para instalar el sistema correctamente es necesario ordenar todos los códigos

Driver/Controller Radio control system

C03010 (2..9 fixtures)
IP20 PUSH

C03010 (2..9 fixtures)
Driver/Controller IP20

C01062

Radio receiver RGB - Ricevitore radio RGB -
Récepteur radio RGB - Radioempfänger RGB -
Receptor de radio RGB

AL2031

Driver 24VDC

C01063

Radio remote control RGB - Radiocomando RGB -
Télécommande radio RGB - RGB-Funkfernbedienung -
Radio control remoto RGB

DAGO RGB

design: Roberto Mantovani

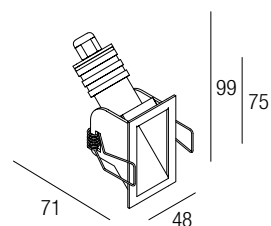

Supply current

Alimentazione
Courant d'alimentation
Stromversorgung
Corriente de alimentación
3 x 350 mA

Power

Potenza
Puissance
Bestuekung
Potencia
3 x 1W

Series wiring

Cablaggio in serie
Câblage en série
Verkabelung in Serie
Cableado en serie



Photometric diagrams

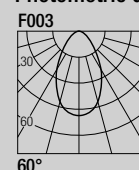

MARUPE RGB

design: Roberto Mantovani

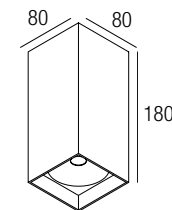

Supply current

Alimentazione
Courant d'alimentation
Stromversorgung
Corriente de alimentación
3 x 350 mA

Power

Potenza
Puissance
Bestuekung
Potencia
3 x 1W

Series wiring

Cablaggio in serie
Câblage en série
Verkabelung in Serie
Cableado en serie



Photometric diagrams

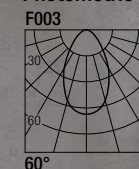

Code Construction

Costruzione del codice - Construction du code produit
Bau der Produkt-Code - Construcción del código de producto

DG 9 X 2 9

Finishing

Finitura Finitions Oberflächenfinish Acabados	1 White Bianco Blanc Weiß Blanco	2 Grey Grigio Gris Grau	5 Black Nero Noir Schwarz Negro
--	--	--	---

Accessories

Accessori - Accessoires
Zubehör - Accesorios

CS1007

Recessing box
Controcassa
Boîtier d'encastrement
Eingieβgehäuse
Caja de empotrar

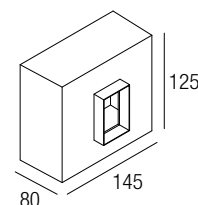

Drivers

Alimentatori - Alimentateurs
Netzteile - Alimentadores

Note: for a correct installation it is necessary to order all the codes
Nota: per installare correttamente il sistema è necessario ordinare tutti i codici

Note: pour installer le système correctement, il est nécessaire de commander tous les codes

Anmerkung: um das System korrekt zu installieren, müssen Sie alle Codes bestellen

Nota: para instalar el sistema correctamente es necesario ordenar todos los códigos

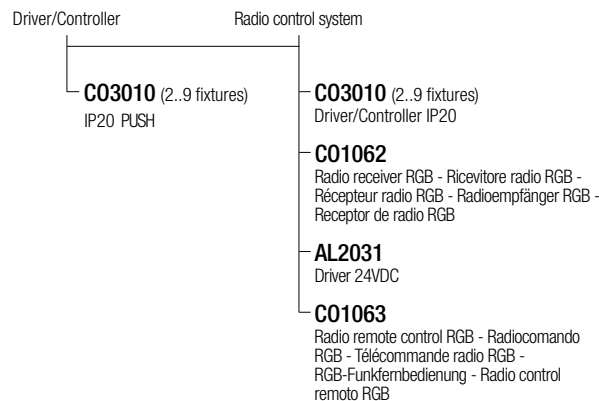

Code Construction

Costruzione del codice - Construction du code produit
Bau der Produkt-Code - Construcción del código de producto

MC X X X X 9

Beam angle

Apertura di fascio Angle de faisceau Strahlwinkel Angulo del haz	2 60°	D Blind Cieco Borgne Ciego
---	-----------------	---

Beam angle

Apertura di fascio Angle de faisceau Strahlwinkel Angulo del haz	2 60°	D Blind Cieco Borgne Ciego
---	-----------------	---

Finishing

Finitura Finitions Oberflächenfinish Acabados	1 White Bianco Blanc Weiß Blanco	2 Grey Grigio Gris Grau	5 Black Nero Noir Schwarz Negro
--	--	--	---

Emission

Emissione Emission	S Single Singola Unique Einzel Único	D Double Doppia Doppel Doble
-----------------------	--	---

Drivers

Alimentatori - Alimentateurs
Netzteile - Alimentadores

Note: for a correct installation it is necessary to order all the codes
Nota: per installare correttamente il sistema è necessario ordinare tutti i codici

Note: pour installer le système correctement, il est nécessaire de commander tous les codes

Anmerkung: um das System korrekt zu installieren, müssen Sie alle Codes bestellen

Nota: para instalar el sistema correctamente es necesario ordenar todos los códigos

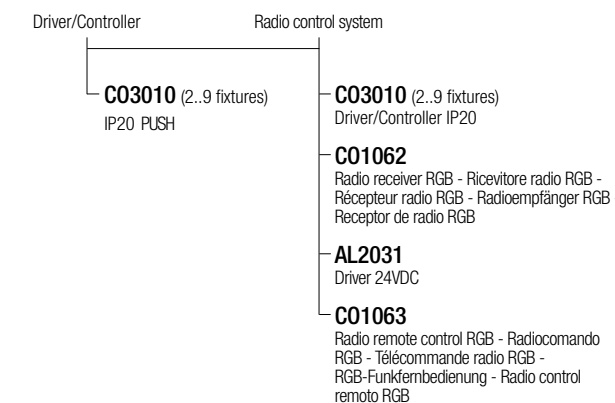

ARIK RGB

design: Roberto Mantovani

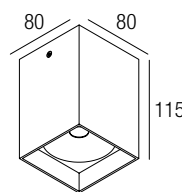
**Supply current**

Alimentazione
Courant d'alimentation
Stromversorgung
Corriente de alimentación

3 x 350 mA**Power**

Potenza
Puissance
Bestuekung
Potencia

3 x 1W**Series wiring**

Cablaggio in serie
Câblage en série
Verkabelung in Serie
Cableado en serie

**Photometric diagrams**

F003

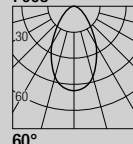

KOINE RGB

design: Roberto Mantovani

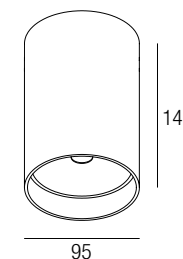
**Supply current**

Alimentazione
Courant d'alimentation
Stromversorgung
Corriente de alimentación

3 x 350 mA**Power**

Potenza
Puissance
Bestuekung
Potencia

3 x 1W**Series wiring**

Cablaggio in serie
Câblage en série
Verkabelung in Serie
Cableado en serie

**Photometric diagrams**

F003

**Code Construction**

Costruzione del codice - Construction du code produit
Bau der Produkt-Code - Construcción del código de producto

AC9 X 2 9**Finishing**

	1	2	5
Finitura	White	Grey	Black
Finitions	Bianco	Grigio	Nero
Oberflächenfinish	Blanc	Gris	Noir
Acabados	Weiß	Grau	Schwarz
	Blanco		Negro

Drivers

Alimentatori - Alimentateurs
Netzteile - Alimentadores

Note: for a correct installation it is necessary to order all the codes
Nota: per installare correttamente il sistema è necessario ordinare tutti i codici

Note: pour installer le système correctement, il est nécessaire de commander tous les codes

Anmerkung: um das System korrekt zu installieren, müssen Sie alle Codes bestellen

Nota: para instalar el sistema correctamente es necesario ordenar todos los códigos

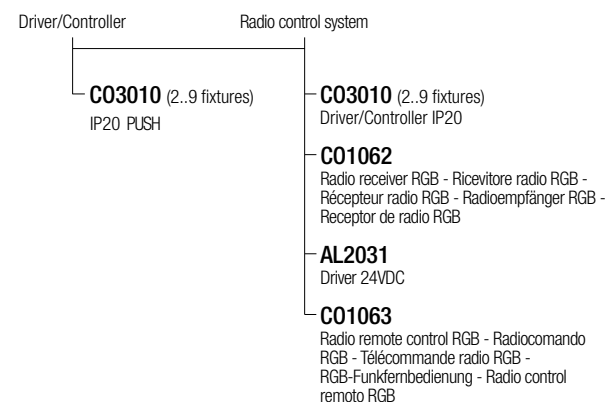
**Code Construction**

Costruzione del codice - Construction du code produit
Bau der Produkt-Code - Construcción del código de producto

KC9 X 2 9**Finishing**

	1	2	5
Finitura	White	Grey	Black
Finitions	Bianco	Grigio	Nero
Oberflächenfinish	Blanc	Gris	Noir
Acabados	Weiß	Grau	Schwarz
	Blanco		Negro

Drivers

Alimentatori - Alimentateurs
Netzteile - Alimentadores

Note: for a correct installation it is necessary to order all the codes
Nota: per installare correttamente il sistema è necessario ordinare tutti i codici

Note: pour installer le système correctement, il est nécessaire de commander tous les codes

Anmerkung: um das System korrekt zu installieren, müssen Sie alle Codes bestellen

Nota: para instalar el sistema correctamente es necesario ordenar todos los códigos

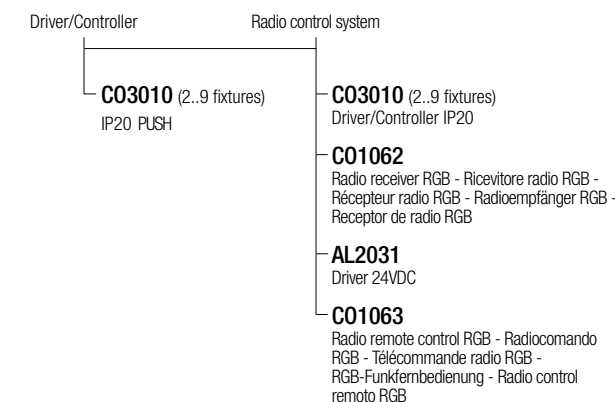

TERA RGB

design: Roberto Mantovani

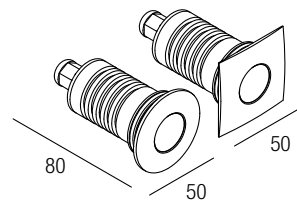

Supply current
Alimentazione
Courant d'alimentation
Stromversorgung
Corriente de alimentación
3 x 350 mA

Power
Potenza
Puissance
Bestuekung
Potencia
3 x 1W

Series wiring
Cablaggio in serie
Câblage en série
Verkabelung in Serie
Cableado en serie

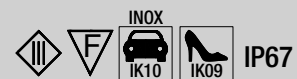

Photometric diagrams

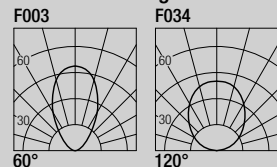

Code Construction

Costruzione del codice - Construction du code produit
Bau der Produkt-Code - Construcción del código de producto

XT9 X X 9 X

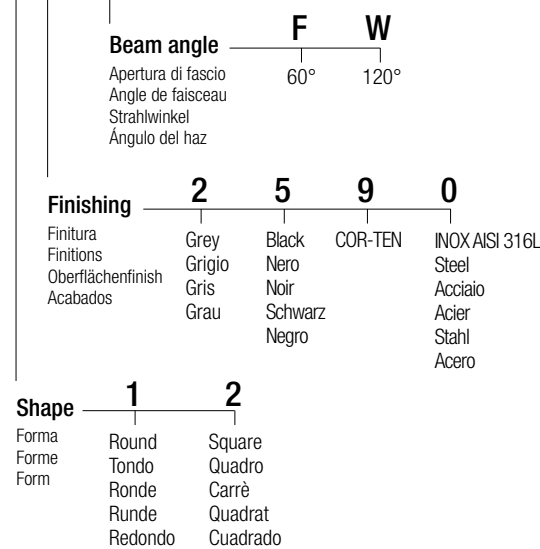

Accessories

Accessori - Accessoires
Zubehör - Accesorios

CSXT01

Recessing box
Controcassa
Boîtier d'encastrement
Eingieβgehäuse
Caja de empotrar

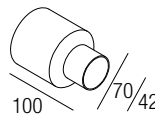

LXT901

Low luminance louver
Filtro antiabbagliamento
Filtre basse luminance
Geringe Leuchtdichte-Filter
Filtro de baja luminancia



Note: the filter must be ordered together with the lighting fixture - **Nota:** il filtro deve essere ordinato congiuntamente all'apparecchio - **Note:** le filtre doit être commandé en même temps que l'appareil - **Anmerkung:** muss der Filter zusammen mit Leuchtkörper bestellt werden
Nota: el filtro debe pedirse junto con la luminaria

Drivers

Alimentatori - Alimentateurs
Netzteile - Alimentadores

Note: for a correct installation it is necessary to order all the codes
Nota: per installare correttamente il sistema è necessario ordinare tutti i codici
Note: pour installer le système correctement, il est nécessaire de commander tous les codes
Anmerkung: um das System korrekt zu installieren, müssen Sie alle Codes bestellen
Nota: para instalar el sistema correctamente es necesario ordenar todos los códigos

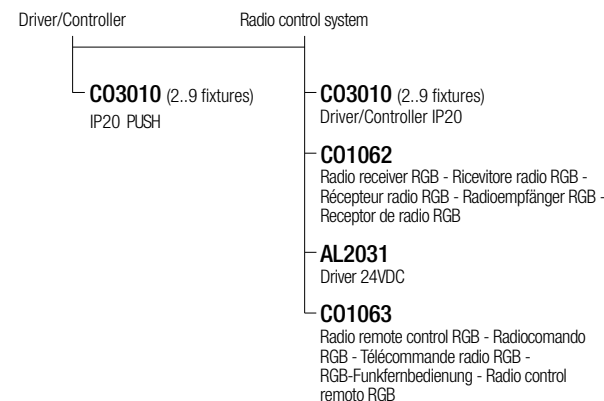

JENA RGB

design: Roberto Mantovani

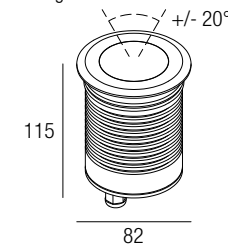

Supply current
Alimentazione
Courant d'alimentation
Stromversorgung
Corriente de alimentación
3 x 350 mA

Power
Potenza
Puissance
Bestuekung
Potencia
3 x 1W

Series wiring
Cablaggio in serie
Câblage en série
Verkabelung in Serie
Cableado en serie

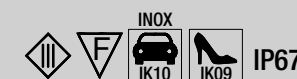

Photometric diagrams

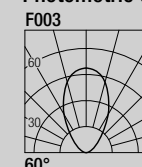

Code Construction

Costruzione del codice - Construction du code produit
Bau der Produkt-Code - Construcción del código de producto

XJ9 X 9

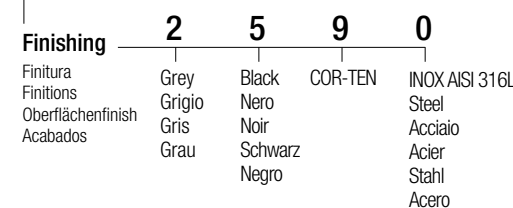

Accessories

Accessori - Accessoires
Zubehör - Accesorios

CSXJ02

Recessing box
Controcassa
Boîtier d'encastrement
Eingieβgehäuse
Caja de empotrar

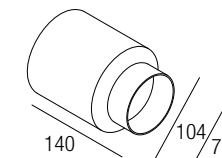

Drivers

Alimentatori - Alimentateurs
Netzteile - Alimentadores

Note: for a correct installation it is necessary to order all the codes
Nota: per installare correttamente il sistema è necessario ordinare tutti i codici
Note: pour installer le système correctement, il est nécessaire de commander tous les codes
Anmerkung: um das System korrekt zu installieren, müssen Sie alle Codes bestellen
Nota: para instalar el sistema correctamente es necesario ordenar todos los códigos

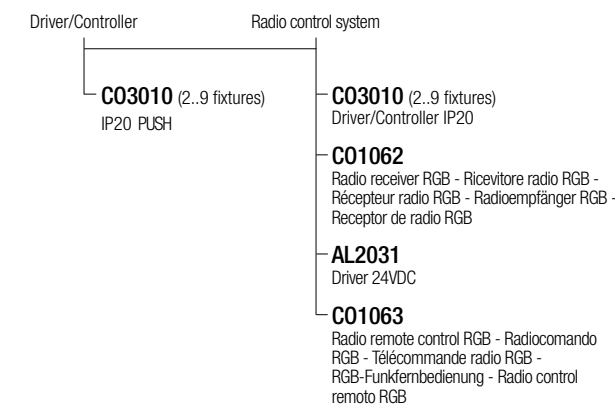

AIR RGB

design: Roberto Mantovani

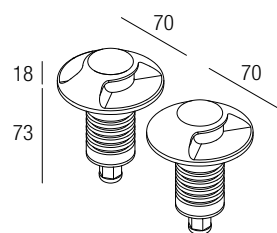

Supply current

Alimentazione
Courant d'alimentation
Stromversorgung
Corriente de alimentación
3 x 350 mA

Power

Potenza
Puissance
Bestuekung
Potencia
3 x 1W

Series wiring

Cablaggio in serie
Câblage en série
Verkabelung in Serie
Cableado en serie

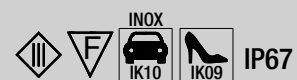

ALOHA RGB

design: Roberto Mantovani

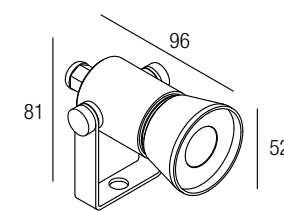

Supply current

Alimentazione
Courant d'alimentation
Stromversorgung
Corriente de alimentación
3 x 350 mA

Power

Potenza
Puissance
Bestuekung
Potencia
3 x 1W

Series wiring

Cablaggio in serie
Câblage en série
Verkabelung in Serie
Cableado en serie



Photometric diagrams

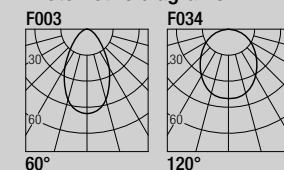

Code Construction

Costruzione del codice - Construction du code produit
Bau der Produkt-Code - Construcción del código de producto

XR X X 9

Finishing

	2	5	9	0
Finitura Finitions Oberflächenfinish Acabados	Grey Grigio Gris Gru	Black Nero Noir Schwarz Negro	COR-TEN	INOX AISI 316L Steel Acciaio Acier Stahl Acero

Emission

	1	2
Emission Émission	Single Singola Unique Einzel Único	Double Doppia Doppel Doble

Accessories

Accessori - Accessoires
Zubehör - Accesorios

CSXT01

Recessing box
Controcassa
Boîtier d'encastrement
Eingießgehäuse
Caja de empotrar

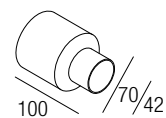

Code Construction

Costruzione del codice - Construction du code produit
Bau der Produkt-Code - Construcción del código de producto

XP9 X 9 X

Beam angle

	F	W
Apertura di fascio Angle de faisceau Strahlwinkel Ángulo del haz	60°	120°

Finishing

	2	5	6
Finitura Finitions Oberflächenfinish Acabados	Aluminium Alluminio Aluminium Aluminio	Black Nero Noir Schwarz Negro	Bronze Bronzo Bronce

Accessories

Accessori - Accessoires
Zubehör - Accesorios

XP0011

Earth spike
Picchetto
Piquet de terre
Erdspieß
Pico de la tierra

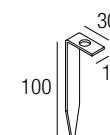

XP0200

Aluminium
Alluminio
Aluminium
Aluminio

XP0500

Black
Nero
Noir
Schwarz
Negro

XP0600

Bronze
Bronzo
Bronce

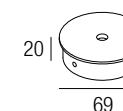

Base
Basis

L0032

Aluminium
Alluminio
Aluminium
Aluminio

L0035

Black
Nero
Noir
Schwarz
Negro

L0036

Bronze
Bronzo
Bronce

Low luminance louver
Filtro antiabbagliamento
Filtre basse luminance
Geringe Leuchtdichte-Filter
Filtro de baja luminancia



XXT01

Tree strap
Cinghia per albero
Courroie d'arbre
Baumbügel
Correa del árbol



Drivers

Alimentatori - Alimentateurs
Netzteile - Alimentadores

Note: for a correct installation it is necessary to order all the codes
Nota: per installare correttamente il sistema è necessario ordinare tutti i codici
Note: pour installer le système correctement, il est nécessaire de commander tous les codes
Anmerkung: um das System korrekt zu installieren, müssen Sie alle Codes bestellen
Nota: para instalar el sistema correctamente es necesario ordenar todos los códigos

Driver/Controller Radio control system

C03010 (2..9 fixtures)
IP20 PUSH

C03010 (2..9 fixtures)
Driver/Controller IP20

C01062

Radio receiver RGB - Ricevitore radio RGB -
Récepteur radio RGB - Radioempfänger RGB -
Receptor de radio RGB

AL2031

Driver 24VDC

C01063

Radio remote control RGB - Radiocomando RGB -
Télécommande radio RGB - RGB-Funkfernbedienung -
Radio control remoto RGB

Drivers

Alimentatori - Alimentateurs
Netzteile - Alimentadores

Note: for a correct installation it is necessary to order all the codes
Nota: per installare correttamente il sistema è necessario ordinare tutti i codici
Note: pour installer le système correctement, il est nécessaire de commander tous les codes
Anmerkung: um das System korrekt zu installieren, müssen Sie alle Codes bestellen
Nota: para instalar el sistema correctamente es necesario ordenar todos los códigos

Driver/Controller Radio control system

C03010 (2..9 fixtures)
IP20 PUSH

C03010 (2..9 fixtures)
Driver/Controller IP20

C01062

Radio receiver RGB - Ricevitore radio RGB -
Récepteur radio RGB - Radioempfänger RGB -
Receptor de radio RGB

AL2031

Driver 24VDC

C01063

Radio remote control RGB - Radiocomando RGB -
Télécommande radio RGB - RGB-Funkfernbedienung -
Radio control remoto RGB

ELLE RGB

design: Roberto Mantovani

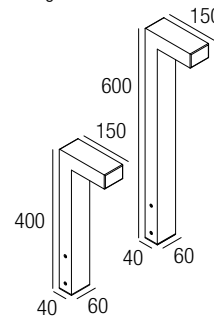

Supply current

Alimentazione
Courant d'alimentation
Stromversorgung
Corriente de alimentación
3 x 350 mA

Power

Potenza
Puissance
Bestuekung
Potencia
3 x 1W

Series wiring

Cablaggio in serie
Câblage en série
Verkabelung in Serie
Cableado en serie



Photometric diagrams

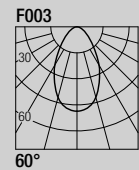

CADMO RGB

design: Roberto Mantovani

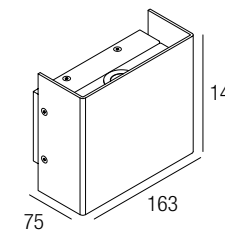

Supply current

Alimentazione
Courant d'alimentation
Stromversorgung
Corriente de alimentación
3 x 350 mA

Power

Potenza
Puissance
Bestuekung
Potencia
3 x 1W

Series wiring

Cablaggio in serie
Câblage en série
Verkabelung in Serie
Cableado en serie



Photometric diagrams

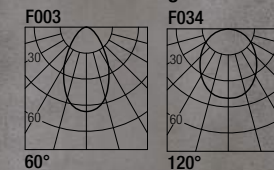

Code Construction

Costruzione del codice - Construction du code produit
Bau der Produkt-Code - Construcción del código de producto

BL X X 9

Finishing

	1	2	5	9
Finitura Finitions Oberflächenfinish Acabados	White Bianco Blanc Weiß Blanco	Grey Grigio Gris Grau	Black Nero Noir Schwarz Negro	COR-TEN

Height

	4	6
Altezza Hauteur Höhe Altura	40 cm	60 cm

Drivers

Alimentatori - Alimentateurs
Netzteile - Alimentadores

Note: for a correct installation it is necessary to order all the codes
Nota: per installare correttamente il sistema è necessario ordinare tutti i codici

Note: pour installer le système correctement, il est nécessaire de commander tous les codes

Anmerkung: um das System korrekt zu installieren, müssen Sie alle Codes bestellen

Nota: para instalar el sistema correctamente es necesario ordenar todos los códigos

Driver/Controller Radio control system

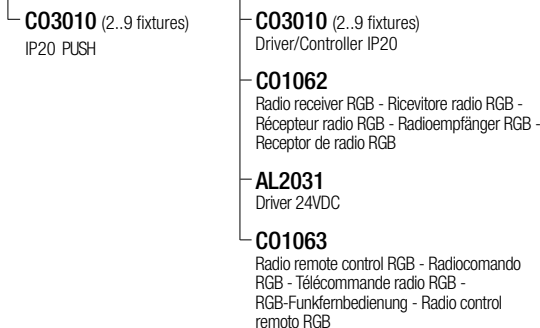

Accessories

Accessori - Accessoires
Zubehör - Accesorios

ZC001

Anchor bolt for concrete plinth
Zanca per plinto cementizio
Boulon d'ancrage pour socle en béton
Ankerbolzen für Betonsockel
Perno de anclaje para zócalo de hormigón

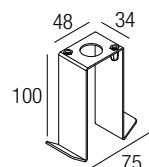

Code Construction

Costruzione del codice - Construction du code produit
Bau der Produkt-Code - Construcción del código de producto

PXS X X 9 X X

Beam angle

	F	W	D
Apertura di fascio Angle de faisceau Strahlwinkel Ángulo del haz	60°	120°	Blind Ciego Borgne Ciego

Beam angle

	F	W	D
Apertura di fascio Angle de faisceau Strahlwinkel Ángulo del haz	60°	120°	Blind Ciego Borgne Ciego

Finishing

	1	2	5	9
Finitura Finitions Oberflächenfinish Acabados	White Bianco Blanc Weiß Blanco	Grey Grigio Gris Grau	Black Nero Noir Schwarz Negro	COR-TEN

Emission

	1	2
Emissione Émission	Single Singola Unique Einzel Único	Double Doppia Doppel Doble

Drivers

Alimentatori - Alimentateurs
Netzteile - Alimentadores

Note: for a correct installation it is necessary to order all the codes
Nota: per installare correttamente il sistema è necessario ordinare tutti i codici

Note: pour installer le système correctement, il est nécessaire de commander tous les codes

Anmerkung: um das System korrekt zu installieren, müssen Sie alle Codes bestellen

Nota: para instalar el sistema correctamente es necesario ordenar todos los códigos

Driver/Controller Radio control system

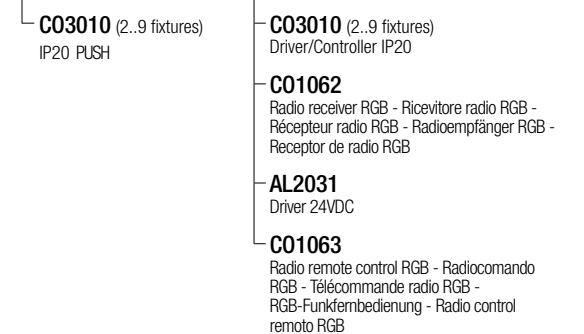

Constant current power supplies non dimmable

Alimentatori in corrente costante non dimmerabili
Alimentations en courant constant non dimmables
Konstantstrom-Netzteile nicht-dimmbare
Alimentadores en corriente constante no regulable

Constant current power supplies are suitable for powering LEDs and COBs. The wiring of the luminaires is in series. The indication S.P., if present, indicates the possibility to wire the luminaires even while the power supply is connected to the mains. If this indication is not present, it is necessary to wire the luminaires before connecting the drivers to the mains.

Gli alimentatori in corrente costante sono ideati per alimentare di LED di potenza e di COB. Il cablaggio degli apparecchi è in serie. L'indicazione S.P., ove presente, indica la possibilità di effettuare il cablaggio degli apparecchi anche con l'alimentatore in tensione. Ove questa indicazione non sia presente, è necessario effettuare il cablaggio degli apparecchi e, solamente dopo averlo completato, fornire alimentazione al driver.

Les alimentations à courant constant conviennent à l'alimentation des LED et des COB. Le câblage des luminaires est en série. L'indication S.P., si présente, indique la possibilité de câbler les luminaires même lorsque l'alimentation est connectée au secteur. Si cette indication n'est pas présente, il est nécessaire de câbler les luminaires avant de brancher les drivers sur le secteur.

Konstantstromnetzteile eignen sich zur Versorgung von LEDs und COBs. Die Verdrahtung der Leuchten erfolgt in Reihe. Die Angabe S.P. weist, falls vorhanden, auf die Möglichkeit hin, die Leuchten zu verdrahten, auch wenn die Stromversorgung an das Stromnetz angeschlossen ist. Wenn diese Anzeige nicht vorhanden ist, müssen die Leuchten verdrahtet werden, bevor die Treiber an das Stromnetz angeschlossen werden.

Las fuentes de alimentación de corriente constante son adecuadas para alimentar LED y COB. El cableado de las luminarias es en serie. La indicación S.P., si está presente, indica la posibilidad de cablear las luminarias incluso cuando la alimentación está conectada a la red eléctrica. Si esta indicación no está presente, es necesario cablear las luminarias antes de conectar los controladores a la red eléctrica.

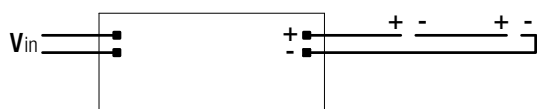

Wiring Diagram

Schema di cablaggio - Schéma de câblage
Schaltplan - Diagrama de cableado





**140 mA**

	AL9014 44 mm IP67	Potenza Power Puissance Bestuekung Potencia	Alimentazione Input voltage Alimentation Speisung Alimentación	V out	Dimensioni Dimensions Größe Dimensiones
		6 W	220..240 VAC	15..40 V	70x38x23 (h)





250 mA

	AL1025 40 mm IP20	Potenza Power Puissance Bestuekung Potencia	Alimentazione Input voltage Alimentation Speisung Alimentación	V out	Dimensioni Dimensions Größe Dimensiones
		10 W	220..240 VAC	2..42 V	115x34x19 (h)
	AL9025 44 mm IP67	Potenza Power Puissance Bestuekung Potencia	Alimentazione Input voltage Alimentation Speisung Alimentación	V out	Dimensioni Dimensions Größe Dimensiones
		10 W	220..240 VAC	20..40 V	70x38x23 (h)

350 mA

	AL1034 30 mm IP20	Potenza Power Puissance Bestuekung Potencia	Alimentazione Input voltage Alimentation Speisung Alimentación	V out	Dimensioni Dimensions Größe Dimensiones
		15 W	220..240 VAC	2..40 V	142x22x19 (h)
	AL1035 40 mm IP20	Potenza Power Puissance Bestuekung Potencia	Alimentazione Input voltage Alimentation Speisung Alimentación	V out	Dimensioni Dimensions Größe Dimensiones
		15 W	220..240 VAC	2..41 V	115x34x19 (h)
	AL1037 55 mm IP20 S.P.	Potenza Power Puissance Bestuekung Potencia	Alimentazione Input voltage Alimentation Speisung Alimentación	V out	Dimensioni Dimensions Größe Dimensiones
		19 W	220..240 VAC	2..54 V	111x52x22 (h)
	AL9011 44 mm IP67	Potenza Power Puissance Bestuekung Potencia	Alimentazione Input voltage Alimentation Speisung Alimentación	V out	Dimensioni Dimensions Größe Dimensiones
		15 W	220..240 VAC	3..42 V	122x38x25 (h)

500 mA

	AL1074 30 mm IP20	Potenza Power Puissance Bestuekung Potencia	Alimentazione Input voltage Alimentation Speisung Alimentación	V out	Dimensioni Dimensions Größe Dimensiones
		14 W	220..240 VAC	2..28 V	142x22x19 (h)
	AL1077 40 mm IP20	Potenza Power Puissance Bestuekung Potencia	Alimentazione Input voltage Alimentation Speisung Alimentación	V out	Dimensioni Dimensions Größe Dimensiones
		12 W	220..240 VAC	2..24 V	115x34x19 (h)
	AL1084 55 mm IP20 S.P.	Potenza Power Puissance Bestuekung Potencia	Alimentazione Input voltage Alimentation Speisung Alimentación	V out	Dimensioni Dimensions Größe Dimensiones
		20 W	220..240 VAC	2..40 V	111x52x22 (h)
	AL9051 44 mm IP67	Potenza Power Puissance Bestuekung Potencia	Alimentazione Input voltage Alimentation Speisung Alimentación	V out	Dimensioni Dimensions Größe Dimensiones
		20 W	220..240 VAC	3..40 V	112x38x25 (h)
	AL9052 44 mm IP67	Potenza Power Puissance Bestuekung Potencia	Alimentazione Input voltage Alimentation Speisung Alimentación	V out	Dimensioni Dimensions Größe Dimensiones
		22W	220..240 VAC	12..44 V	112x38x25 (h)

Dimmable Constant current power supplies

Alimentatori in corrente costante dimmerabili
 Alimentations en courant constant dimmables
 Konstantstrom-Netzteile dimmbare
 Alimentadores en corriente constante regulable

Dimmable constant current power supplies are suitable for powering LEDs and COBs. The wiring of the luminaires is in series. Dimming management modes are indicated by the indications: PUSH - management via Normally Open Push Button; 0/1-10V - management via 0/1-10V signal; DALI - management via DALI signal.

Gli alimentatori dimmerabili in corrente costante sono idonei all'alimentazione di LED di potenza e di COB. Il cablaggio degli apparecchi è in serie. Le modalità di gestione della dimmerazione sono segnalate dalle indicazioni: PUSH - gestione tramite pulsante normalmente aperto; 0/1-10V - gestione tramite segnale 0/1-10V; DALI - gestione tramite segnale DALI.

Les alimentations à courant constant dimmables conviennent à l'alimentation des LED et des COB. Le câblage des luminaires est en série. Les modalités de gestion de la variation d'intensité sont indiquées par les indications : PUSH - gestion via bouton normalement ouvert ; 0/1-10V - gestion via signal 0/1-10V ; DALI - gestion via signal DALI.

Dimmbare Konstantstromnetzteile eignen sich zur Versorgung von LEDs und COBs. Die Verkabelung der Geräte ist serienmäßig. Auf die Dimm-Modalitäten weisen die folgenden Hinweise hin: PUSH - Steuerung mit einem normalerweise offenem Taster; 0/1-10V - Steuerung über Signal 0/1-10V; DALI - Steuerung über DALI Signal.





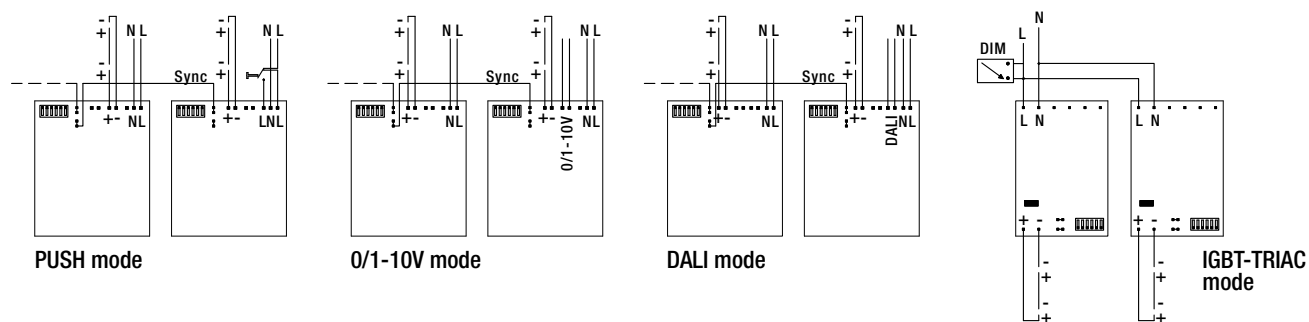

Las fuentes de alimentación de corriente constante regulables son adecuadas para alimentar LED y COB. El cableado de los aparatos es en serie. Las modalidades de gestión de la regulación están señaladas por las indicaciones: PUSH - gestión mediante botón normalmente abierto; 0/1-10V - gestión mediante señal 0/1-10V; DALI - gestión mediante señal DALI.

Wiring Diagram







Schema di cablaggio - Schéma de câblage
 Schaltplan - Diagrama de cableado



250 mA

	AL4030 0/1-10V	Potenza Power Puissance Bestuekung Potencia	Alimentazione Input voltage Alimentation Speisung Alimentación	V out	Dimensioni Dimensions Größe Dimensiones
	 IP20	14 W	220..240 VAC	2..53 V	111x52x22 (h)
	AL4031 DALI	Potenza Power Puissance Bestuekung Potencia	Alimentazione Input voltage Alimentation Speisung Alimentación	V out	Dimensioni Dimensions Größe Dimensiones
	 IP20	10 W	220..240 VAC	15..43 V	111x52x22 (h)
	AL4032 IGBT-TRIAC	Potenza Power Puissance Bestuekung Potencia	Alimentazione Input voltage Alimentation Speisung Alimentación	V out	Dimensioni Dimensions Größe Dimensiones
	 IP20	12,5 W	220..240 VAC	25..50 V	111x52x22 (h)

350 mA

	AL4000 PUSH 0/1-10V	Potenza Power Puissance Bestuekung Potencia	Alimentazione Input voltage Alimentation Speisung Alimentación	V out	Dimensioni Dimensions Größe Dimensiones	Sincronizzabili Synchronizable Synchronisable Synchronisierbar Synchronizable	Cavetto sincronizzazione Synchronization cable Câble de synchronisation Synchronisationskabel Cable de sincronización
	 IP20	15 W	220..240 VAC	2..42 V	103x67x21 (h)	max 10 drivers	AL4100 (1,5 mt)
	AL4051 DALI 2	Potenza Power Puissance Bestuekung Potencia	Alimentazione Input voltage Alimentation Speisung Alimentación	V out	Dimensioni Dimensions Größe Dimensiones	Sincronizzabili Synchronizable Synchronisable Synchronisierbar Synchronizable	Cavetto sincronizzazione Synchronization cable Câble de synchronisation Synchronisationskabel Cable de sincronización
	 IP20	17 W	220..240 VAC	5..48 V	103x67x21 (h)	max 10 drivers	AL4100 (1,5 mt)
	AL4053 PUSH IGBT-TRIAC	Potenza Power Puissance Bestuekung Potencia	Alimentazione Input voltage Alimentation Speisung Alimentación	V out	Dimensioni Dimensions Größe Dimensiones	Sincronizzabili Synchronizable Synchronisable Synchronisierbar Synchronizable	Cavetto sincronizzazione Synchronization cable Câble de synchronisation Synchronisationskabel Cable de sincronización
	 IP20	17 W	220..240 VAC	2..47 V	166x46x34 (h)	max 10 drivers PUSH mode only	AL4100 (1,5 mt) PUSH mode only
	AL8035 DALI	Potenza Power Puissance Bestuekung Potencia	Alimentazione Input voltage Alimentation Speisung Alimentación	V out	Dimensioni Dimensions Größe Dimensiones		
	 IP67	19,5 W	220..240 VAC	9..55 V	185x35x33 (h)		

500 mA

	AL4010 PUSH 0/1-10V	Potenza Power Puissance Bestuekung Potencia	Alimentazione Input voltage Alimentation Speisung Alimentación	V out	Dimensioni Dimensions Größe Dimensiones	Sincronizzabili Synchronizable Synchronisable Synchronisierbar Synchronizable	Cavetto sincronizzazione Synchronization cable Câble de synchronisation Synchronisationskabel Cable de sincronización
	 IP20	21 W	220..240 VAC	2..42 V	103x67x21 (h)	max 10 drivers	AL4100 (1,5 mt)
	AL4151 DALI 2	Potenza Power Puissance Bestuekung Potencia	Alimentazione Input voltage Alimentation Speisung Alimentación	V out	Dimensioni Dimensions Größe Dimensiones	Sincronizzabili Synchronizable Synchronisable Synchronisierbar Synchronizable	Cavetto sincronizzazione Synchronization cable Câble de synchronisation Synchronisationskabel Cable de sincronización
	 IP20	24 W	220..240 VAC	5..48 V	103x67x21 (h)	max 10 drivers	AL4100 (1,5 mt)
	AL4153 PUSH IGBT-TRIAC	Potenza Power Puissance Bestuekung Potencia	Alimentazione Input voltage Alimentation Speisung Alimentación	V out	Dimensioni Dimensions Größe Dimensiones	Sincronizzabili Synchronizable Synchronisable Synchronisierbar Synchronizable	Cavetto sincronizzazione Synchronization cable Câble de synchronisation Synchronisationskabel Cable de sincronización
	 IP20	24 W	220..240 VAC	2..47 V	166x46x34 (h)	max 10 drivers PUSH mode only	AL4100 (1,5 mt) PUSH mode only
	AL8050 DALI	Potenza Power Puissance Bestuekung Potencia	Alimentazione Input voltage Alimentation Speisung Alimentación	V out	Dimensioni Dimensions Größe Dimensiones		
	 IP67	27,5 W	220..240 VAC	9..55 V	185x35x33 (h)		

Constant Voltage power supplies

Alimentatori in tensione costante
 Alimentations en tension constant
 Konstantspannung-Netzteile
 Fuentes de alimentación de voltaje constante

Constant voltage power supplies are suitable for powering 24VDC luminaires. The wiring of the luminaires is in parallel.

Gli alimentatori in tensione costante sono ideati per alimentare apparecchi a 24VDC. Il cablaggio degli apparecchi è in parallelo.

Les alimentateurs en tension constante sont adaptés pour l'alimentation d'appareils à 24VDC. Le câblage des appareils est en parallèle.

Die Konstantspannungs-Netzteile eignen sich zur 24VDC Speisung der Geräte. Die Verkabelung der Geräte wird parallel geschaltet.

Los alimentadores en tensión constante son idóneos para la alimentación de aparatos a 24VDC. El cableado de los aparatos es en paralelo.

Wiring Diagram

Schema di cablaggio - Schéma de câblage
 Schaltplan - Diagrama de cableado

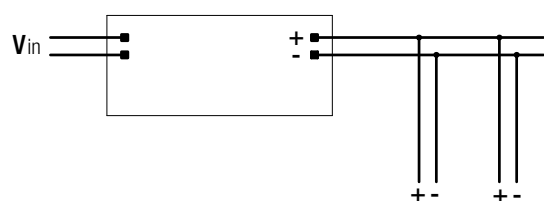

24 VDC

Model	Power	Input voltage	I out max	Dimensions
AL2012 60 mm IP20	25 W	220..240 VAC	1040 mA	146x55x19 (h)
AL2031 70 mm IP20	70 W	220..240 VAC	2900 mA	225x60x36 (h)
AL2040 80 mm IP20	150 W	220..240 VAC	6250 mA	240x60x49 (h)
AL9212 IP68	20 W	220..240 VAC	830 mA	105(d)x74 (h)
AL9231 IP67	70 W	220..240 VAC	2900 mA	268x66x51 (h)
AL9240 IP67	150 W	220..240 VAC	6250 mA	268x66x51 (h)

Constant Voltage dimming systems

Sistemi per la dimmerazione in tensione costante
 Systèmes de dimmage en tension constant
 Konstantspannung Dimm-Systeme
 Sistemas para la regulación en tensión constante

The dimming systems allow you to adjust brightness. The procedure to manage the dimming is given in the indications: PUSH - management via a button that is normally open; 0/1-10V - management via signal 0/1-10V; DALI - management via DALI signal. Each control element can be associated with up to 10 slave modules. The capacity of each module corresponds to the associated power supply, up to a maximum of 10 A.

I sistemi di dimmerazione permettono la regolazione della luminosità. Le modalità di gestione della dimmerazione sono segnalate dalle indicazioni: PUSH - gestione tramite pulsante normalmente aperto; 0/1-10V - gestione tramite segnale 0/1-10V; DALI - gestione tramite segnale DALI. Ogni elemento di comando può essere associato a massimo 10 moduli slave. La portata di ogni modulo corrisponde a quella dell'alimentatore associato, fino ad un massimo di 10 A.

Les systèmes de variation d'intensité permettent de régler la luminosité. Les modalités de gestion de la variation d'intensité sont indiquées par les indications: PUSH - gestion via bouton normalement ouvert; 0/1-10V - gestion via signal 0/1-10V; DALI - gestion via signal DALI. Chaque élément de commande peut être associé à un maximum de 10 modules slave. La portée de chaque module correspond à celle de l'alimentateur associé, jusqu'à un maximum de 10 A.

Mithilfe der Dimm-Systeme kann man die Lichtstärke steuern. Auf die Dimm-Modalitäten weisen die folgenden Hinweise hin: PUSH - Steuerung mit einem normalerweise offenem Taster; 0/1-10V - Steuerung über Signal 0/1-10V; DALI - Steuerung über DALI Signal. Jedes Steuerelement kann maximal mit 10 Slave-Modulen verbunden werden. Die Stromfähigkeit jedes Moduls entspricht der des damit verbundenen Netzteils, bis maximal 10 A.

Los sistemas de regulación permiten la regulación de la luminosidad. Las modalidades de gestión de la regulación están señaladas por las indicaciones: PUSH - gestión mediante botón normalmente abierto; 0/1-10V - gestión mediante señal 0/1-10V; DALI - gestión mediante señal DALI. Cada elemento de mando se puede asociar a un máximo de 10 módulos esclavos. La capacidad de cada módulo corresponde a la del alimentador asociado, hasta un máximo de 10 A.

Wiring Diagram

Schema di cablaggio - Schéma de câblage
 Schaltplan - Diagrama de cableado

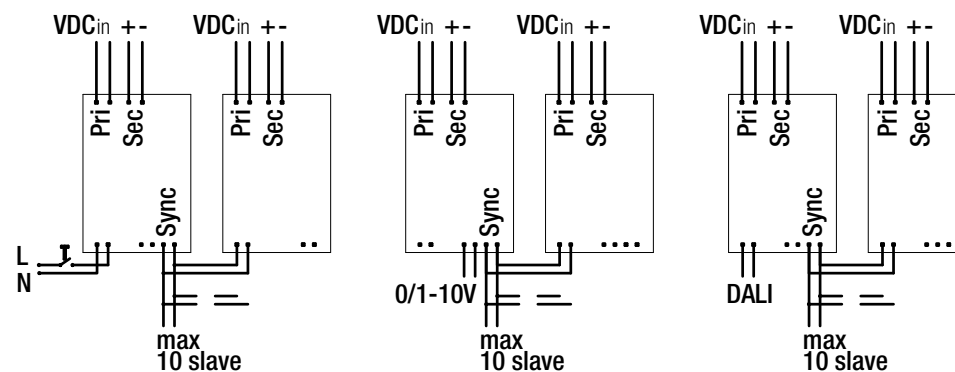

Dimming module

AL7035 PUSH 0/1-10V DALI master/slave IP20	Tensione di Alimentazione Input voltage Tension d'alimentation Versorgungsspannung Tensión de alimentación	I out max	Dimensioni Dimensions Größe Dimensiones
	12..48 VDC	12 A	156x38x24,5 (h)

Dimmable Constant Voltage power supplies

Alimentatori in tensione costante dimmerabili
 Alimentations en tension constant dimmables
 Dimmbare Konstantspannung-Netzteile
 Fuentes de alimentación de voltaje constante regulables

Dimmable constant voltage power supplies are suitable for powering 24VDC luminaires. The wiring of the luminaires is in parallel. Dimming management modes are indicated by the indications: PUSH - management via Normally Open Push Button; 0/1-10V - management via 0/1-10V signal; DALI - management via DALI signal.

Gli alimentatori dimmerabili in tensione costante sono idonei all'alimentazione di apparecchi a 24VDC. Il cablaggio degli apparecchi è in parallelo. Le modalità di gestione della dimmerazione sono segnalate dalle indicazioni: PUSH - gestione tramite pulsante normalmente aperto; 0/1-10V - gestione tramite segnale 0/1-10V; DALI - gestione tramite segnale DALI.

Les alimentations à tension constante à gradation conviennent à l'alimentation des luminaires 24VDC. Le câblage des luminaires est en parallèle. Les modalités de gestion de la variation d'intensité sont indiquées par les indications: PUSH - gestion via bouton normalement ouvert; 0/1-10V - gestion via signal 0/1-10V; DALI - gestion via signal DALI.

Dimmbare Konstantspannungsnetzteile eignen sich zur Versorgung von 24VDC-Leuchten. Die Verdrahtung der Leuchten erfolgt parallel. Auf die Dimm-Modalitäten weisen die folgenden Hinweise hin: PUSH - Steuerung mit einem normalerweise offenem Taster; 0/1-10V - Steuerung über Signal 0/1-10V; DALI - Steuerung über DALI Signal.

Las fuentes de alimentación de tensión constante regulables son adecuadas para alimentar luminarias de 24 V CC. El cableado de las luminarias es en paralelo. Las modalidades de gestión de la regulación están señaladas por las indicaciones: PUSH - gestión mediante botón normalmente abierto; 0/1-10V - gestión mediante señal 0/1-10V; DALI - gestión mediante señal DALI.

Voltage/Current converters

Convertitori tensione/corrente costante
 Convertisseur tension/courant constant
 Konverter Spannung/Konstantstrom
 Convertidores de tensión constante /corriente constante

Converters allow to make constant voltage lines from 12 to 48 VDC to those which the luminaires are wired in parallel. The wiring of the converters is in series and it is necessary to wire the luminaires before connecting the drivers to the mains.

I convertitori consentono di realizzare linee in tensione costante da 12 a 48 VDC alle quali gli apparecchi vengono collegati in parallelo. Il cablaggio a valle dei convertitori deve essere fatto in serie, è inoltre necessario effettuare il cablaggio degli apparecchi e, solamente dopo averlo completato, fornire alimentazione al driver.

Des convertisseurs permettent de réaliser des lignes à tension constante de 12 à 48 VDC à celles dont les luminaires sont câblés en parallèle. Le câblage des convertisseurs est en série et il est nécessaire de câbler les luminaires avant de brancher les drivers sur le secteur.

Konverter ermöglichen die Herstellung von Konstantspannungsleitungen von 12 bis 48 VDC zu denen, zu denen die Leuchten parallel verdrahtet sind. Die Verdrahtung der Konverter erfolgt in Reihe und es ist notwendig, die Leuchten zu verdrahten, bevor die Treiber an das Stromnetz angeschlossen werden.

Los convertidores permiten realizar líneas de tensión constante de 12 a 48 VDC a las que se cablean las luminarias en paralelo. El cableado de los convertidores es en serie y es necesario cablear las luminarias antes de conectar los drivers a la red eléctrica.

Wiring Diagram

Schema di cablaggio - Schéma de câblage
 Schaltplan - Diagrama de cableado

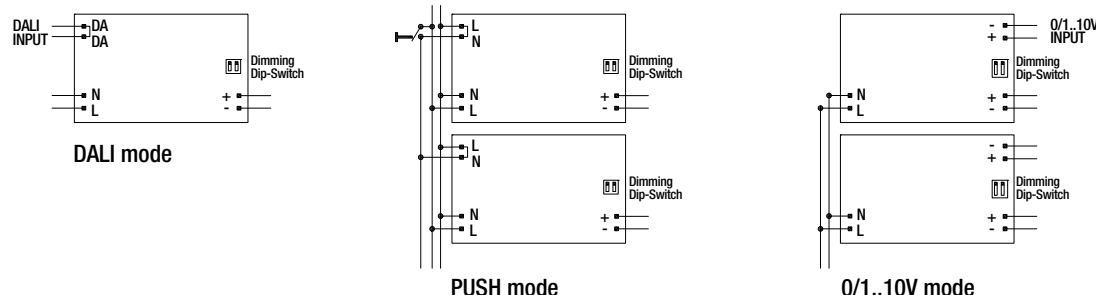

Wiring Diagram

Schema di cablaggio - Schéma de câblage
 Schaltplan - Diagrama de cableado



24 VDC



AL5012
PUSH 0/1-10V
DALI

Potenza
 Power
 Puissance
 Bestuekung
 Potencia

IP20

AL8012
DALI

Potenza
 Power
 Puissance
 Bestuekung
 Potencia

IP67

Alimentazione
 Input voltage
 Alimentation
 Speisung
 Alimentación

24 W

Alimentazione
 Input voltage
 Alimentation
 Speisung
 Alimentación

24 W

I out max

1000 mA

I out max

1000 mA

Dimensioni
 Dimensions
 Größe
 Dimensiones

150x38x24,5 (h)

Dimensioni
 Dimensions
 Größe
 Dimensiones

185x35x33 (h)

350 mA



AL7021

25 mm
 IP20

Potenza
 Power
 Puissance
 Bestuekung
 Potencia

16 W

V in

12..48 VDC

I out

350 mA

Dimensioni
 Dimensions
 Größe
 Dimensiones

57x19x16 (h)

500 mA



AL7022

25 mm
 IP20

Potenza
 Power
 Puissance
 Bestuekung
 Potencia

22,5 W

V in

12..48 VDC

I out

500 mA

Dimensioni
 Dimensions
 Größe
 Dimensiones

57x19x16 (h)

RGB 3x350mA Driver/Controller

Sistemi di alimentazione e controllo RGB in corrente costante 3x350 mA
 Systèmes d'alimentation et de contrôle RGB en courant constant 3x350 mA
 RGB Konstantstrom-Speisungs- und Steuerungssysteme 3x350 mA
 Sistemas de alimentación y control RGB en corriente constante 3x350 mA

The systems provide single power and control equipment for RGB 3x350 mA luminaires. Prepared to be managed via a button that is normally open, you can also manage the control via radio control using the appropriate accessories. The wiring of the luminaires is standard. It is necessary to make a wiring harness for the luminaires and supply power to the driver only after completing it.

I sistemi offrono in un singolo apparato alimentazione e controllo per apparecchi RGB 3x350 mA. Predisposti per gestione tramite pulsante normalmente aperto, è possibile gestire il controllo anche tramite radiocomando utilizzando gli appositi accessori. Il cablaggio degli apparecchi è in serie. È necessario effettuare il cablaggio degli apparecchi e, solamente dopo averlo completato, fornire alimentazione al driver.

Les systèmes offrent, dans un seul appareillage, l'alimentation et le contrôle pour appareils RGB 3x350 mA. Prêdisposés pour gestion via un bouton normalement ouvert, il est également possible de gérer le contrôle via radiocommande à l'aide des accessoires spéciaux. Le câblage des appareils est en série. Il faut effectuer le câblage des appareils et, seulement après l'avoir complété, fournir l'alimentation au driver.

Diese Systeme bieten in einem einzigen Gerät die Speisung und die Steuerung der RGB Geräte 3x350 mA. Vorbereitet zur Steuerung mit normalerweise offenen Tastern, mithilfe des entsprechenden Zubehörs, ist auch die Steuerung mit Fernbedienung möglich. Die Verkabelung der Geräte wird in Reihe geschaltet. Man muss zuerst die Geräte verkabeln und nur nach Abschluss der Arbeiten kann man den Driver speisen.

Los sistemas ofrecen en un solo aparato alimentación y control para aparatos RGB 3x350 mA. Preparados para gestión mediante botón normalmente abierto, es posible gestionar el control también a través de mando a distancia utilizando los accesorios correspondientes. El cableado de los aparatos es en serie. Es necesario efectuar el cableado de los aparatos y, solamente tras haberlo completado, suministrar alimentación al controlador.

Connection systems

Sistemi di connessione
 Systèmes de connexion
 Systeme der Verbindung
 Sistemas de conexión

CN5665

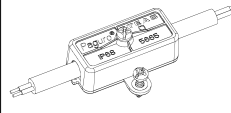
	Uscite Ways Sorties Ausgänge Salidas	Connessione Connection Connexions Verbindungen Conexiones	Dimensioni Dimensions Taille Grösse Tamaño	Diametro esterno cavo (min-max) External diameter of the cable (min-max) Diamètre extérieur du câble (min-max) Außendiameter des Kabels (min-max) Diámetro externo del cable (min-max)
IP68 250 V 6 A	2	2x0,75mm ²	44x27x17,5mm	4,8-6mm

CN5630

	Uscite Ways Sorties Ausgänge Salidas	Connessione Connection Connexions Verbindungen Conexiones	Dimensioni Dimensions Taille Grösse Tamaño	Diametro esterno cavo (min-max) External diameter of the cable (min-max) Diamètre extérieur du câble (min-max) Außendiameter des Kabels (min-max) Diámetro externo del cable (min-max)
IP68 1 kV	2	2x1,5mm ²	37x36,5x22mm	6-8mm

CN5633

	Uscite Ways Sorties Ausgänge Salidas	Connessione Connection Connexions Verbindungen Conexiones	Dimensioni Dimensions Taille Grösse Tamaño	Diametro esterno cavo (min-max) External diameter of the cable (min-max) Diamètre extérieur du câble (min-max) Außendiameter des Kabels (min-max) Diámetro externo del cable (min-max)
IP68 1 kV	2	3x1,5mm ²	38x42,5x29,5mm	8-10mm

CN5695-1

	Uscite Ways Sorties Ausgänge Salidas	Connessione Connection Connexions Verbindungen Conexiones	Dimensioni Dimensions Taille Grösse Tamaño	Diametro esterno cavo (min-max) External diameter of the cable (min-max) Diamètre extérieur du câble (min-max) Außendiameter des Kabels (min-max) Diámetro externo del cable (min-max)
IP68 250 V 10 A	2	3x1,5mm ²	L:70mm Ø:23mm	5,5-10mm

CN5695-3

	Uscite Ways Sorties Ausgänge Salidas	Connessione linea Mainline connection Ligne principal connexions Hauptlinie Verbindungen Linea principal conexiones	Dimensioni Dimensions Taille Grösse Tamaño	Diametro esterno cavo-Linea (min-max) External diameter of the cable-Mainline (min-max) Diamètre extérieur du câble-Ligne principal (min-max) Außendiameter des Kabels-Hauptlinie (min-max) Diámetro externo del cable-Linea principal (min-max)
IP68 250 V 16 A	3	3x2,5mm ²	83x68,5x19,5mm	6,5-12mm
		Connessione derivazione Derivation connection Derivation connexions Ableitung Verbindungen Derivación conexiones		Diametro esterno cavo-Derivazione(min-max) External diameter of the cable-Derivation (min-max) Diamètre extérieur du câble-Derivation (min-max) Außendiameter des Kabels-Ableitung (min-max) Diámetro externo del cable-Derivación (min-max)
		3x1,5mm ²		5,5-10mm



C03010

PUSH
min 2 - max 9
LED RGB

IP20

Potenza
Power
Puissance
Bestuekung
Potencia

35 W

Dimensioni
Dimensions
Größe
Dimensiones

147x75x39 (h)

Sincronizzabili
Synchronizable
Synchronisable
Synchronisierbar
Sncronizable

max 10 drivers

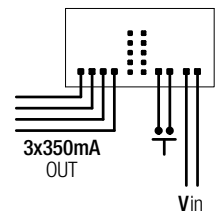

Accessories

Accessori - Accessoires
Zubehör - Accesorios

C01062

Radio receiver RGB
Ricevitore radio RGB
Récepteur radio RGB
Radioempfänger RGB
Receptor de radio RGB

AL2031

Driver 24VDC

C01063

Radio remote control RGB
Radiocomando RGB
Télécommande radio RGB
RGB-Funkfernbedienung
Radio control remoto RGB

Note: for a correct installation it is necessary to order all the codes
Nota: per installare correttamente il sistema è necessario ordinare tutti i codici
Note: pour installer le système correctement, il est nécessaire de commander tous les codes
Anmerkung: um das System korrekt zu installieren, müssen Sie alle Codes bestellen
Nota: para instalar el sistema correctamente es necesario ordenar todos los códigos

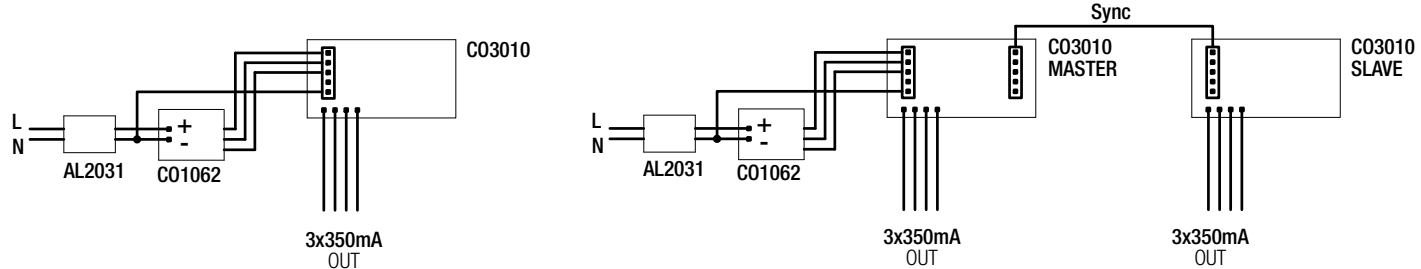

Recessing boxes for on-site mixed concrete constructions

Scatole da incasso per costruzioni in cemento armato gettato in opera
Boîtes d'encastrement pour constructions en béton mixte sur site
Einbaudosen für Ortbetonkonstruktionen
Cajas de empotrar para construcciones de hormigón mixto en obra

To know the combination of items needed for the installation of each product, please contact the technical department.
Per conoscere la combinazione degli articoli necessari all'installazione di ciascun prodotto si prega di contattare l'ufficio tecnico.
Pour connaître la combinaison d'éléments nécessaires à l'installation de chaque produit, veuillez contacter le service technique.
Wenden Sie sich bitte an die technische Abteilung, um die für die Installation jedes Produkts erforderliche Kombination von Artikeln zu erfahren.
Para conocer la combinación de elementos necesarios para la instalación de cada producto, póngase en contacto con el departamento técnico.

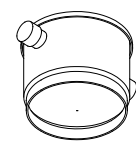
CSK01

Housing diameter
Diametro della cassaforma
Diamètre de coffrage
Schalungsdurchmesser
Diámetro del encofrado

Ø130mm

LED wattage max.
Wattaggio LED max.
Puissance LED max.
LED-Leistung max.
LED potencia máx.

20W

Max. installation depth luminaire
Max. profondità di incasso dell'apparecchio
Max. luminaire de profondeur d'installation
Max. Einbautiefe Leuchte
Máx. luminaria de profundidad de instalación

110mm

Combination entries for M20/M25 conduits
Ingressi combinati per tubi M20/M25
Entrées combinées pour conduits M20/M25
Kombinationseinführungen für M20/M25-Rohre
Entradas combinadas para conductos M20/M25

2

Depth including front part CSK06
Profondità inclusa la parte frontale CSK06
Profondeur y compris partie avant CSK06
Tiefe einschließlich Frontteil CSK06
Profundidad incluida la parte frontal CSK06

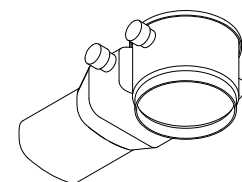
Ø120mm**CSK02**

Housing diameter
Diametro della cassaforma
Diamètre de coffrage
Schalungsdurchmesser
Diámetro del encofrado

Ø130mm

LED wattage max.
Wattaggio LED max.
Puissance LED max.
LED-Leistung max.
LED potencia máx.

20W

Max. installation depth luminaire
Max. profondità di incasso dell'apparecchio
Max. luminaire de profondeur d'installation
Max. Einbautiefe Leuchte
Máx. luminaria de profundidad de instalación

110mm

Combination entries for M20/M25 conduits
Ingressi combinati per tubi M20/M25
Entrées combinées pour conduits M20/M25
Kombinationseinführungen für M20/M25-Rohre
Entradas combinadas para conductos M20/M25

4

Depth including front part CSK06
Profondità inclusa la parte frontale CSK06
Profondeur y compris partie avant CSK06
Tiefe einschließlich Frontteil CSK06
Profundidad incluida la parte frontal CSK06

Ø120mm

Tunnel dimensions
Dimensioni del tunnel
Dimensions du tunnel
Abmessungen des Tunnels
Dimensiones del tunel

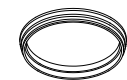
190x140x85mm**CSK03** Extension ring - Anello di espansione - Anneau d'expansion - Erweiterungsring - Anillo de expansión

Height
Altezza
Hauteur
Höhe
Altura

10mm

Note - Nota - Anmerkung
To increase installation depth
Per aumentare la profondità di incasso
Pour augmenter la profondeur d'installation
Zur Erhöhung der Einbautiefe
Para aumentar la profundidad de instalación

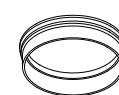
CSK04 Extension ring - Anello di espansione - Anneau d'expansion - Erweiterungsring - Anillo de expansión

Height
Altezza
Hauteur
Höhe
Altura

25mm

Note - Nota - Anmerkung
To increase installation depth
Per aumentare la profondità di incasso
Pour augmenter la profondeur d'installation
Zur Erhöhung der Einbautiefe
Para aumentar la profundidad de instalación

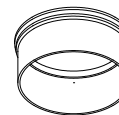
CSK05 Extension ring - Anello di espansione - Anneau d'expansion - Erweiterungsring - Anillo de expansión

Height
Altezza
Hauteur
Höhe
Altura

55mm

Note - Nota - Anmerkung
To increase installation depth
Per aumentare la profondità di incasso
Pour augmenter la profondeur d'installation
Zur Erhöhung der Einbautiefe
Para aumentar la profundidad de instalación

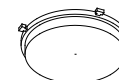
CSK06 Universal plastic front part - Parte frontale universale in plastica - Façade universelle en plastique - Universalfront aus Kunststoff - Frente universal en plástico

Ceiling exit
Uscita a soffitto
Sortie au plafond
Deckenausgang
Salida de techo

0-100mm

Note - Nota - Anmerkung
This front part is not suitable for exposed concrete ceilings
Questa parte frontale non è adatta per soffitti in cemento facciavista
Cette partie avant n'est pas adaptée pour faire face à des plafonds en béton
Dieses Vorderteil ist nicht für die Verkleidung von Betondecken geeignet
Esta parte frontal no es apta para revestir techos de hormigón

Finishing

Finiture - Finitions - Oberflächenfinish - Acabados



White
Bianco
Blanc
Weiß
Blanco



Aluminium
Alluminio
Aluminium
Aluminio



Black
Nero
Noir
Schwarz
Negro



Bronze
Bronzo
Bronce



Titanium
Titanio
Titane
Titan

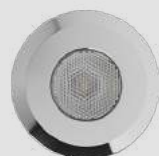

Chrome
Cromo
Chrom

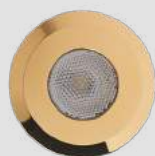

Gold
Oro
Or



INOX AISI 316L
Steel Acciaio
Acier
Stahl
Acero



COR-TEN



Grey
Grigio
Gris
Grau

IP X X

- 0** Unprotected
- 1** Protected from objects bigger than 50mm Ø
- 2** Protected from objects bigger than 12,5mm Ø
- 3** Protected from objects bigger than 2,5mm Ø
- 4** Protected from objects bigger than 1mm Ø
- 5** Protected against dust ingress, not harmful deposits
- 6** Completely protected against dust

IP X X

- 0** Unprotected
- 1** Protected against vertically falling water drops
- 2** Protected against vertically falling water drops when enclosure is tilted up to 15°
- 3** Protected against water sprayed at an angle up to 60° on either side of the vertical
- 4** Protected against water splashed against the component from any direction
- 5** Protected against water projected in jets from any direction
- 6** Protected against water projected in powerful jets from any direction
- 7** Protected against temporary immersion in water
- 8** Protected against continuous immersion in water

	IK00	IK01	IK02	IK03	IK04	IK05	IK06	IK07	IK08	IK09	IK10
Energy (J)	--	0,15	0,20	0,35	0,50	0,70	1,00	2,00	5,00	10,00	20,00
Mass and height of the piece	--	0,2 Kg 70mm	0,2 Kg 100mm	0,2 Kg 175mm	0,2 Kg 250mm	0,2 Kg 350mm	0,5 Kg 200mm	0,5 Kg 400mm	1,7 Kg 295mm	5 Kg 200mm	5 Kg 400mm

Wires section / Distances from drivers

24VDC - max 70W

Distance	5 mt	10 mt	20 mt	30 mt
Section	0,75 mm ²	1 mm ²	1,5 mm ²	2,5 mm ²

24VDC - max 150W

Distance	5 mt	10 mt	20 mt	30 mt
Section	1,50 mm ²	2,5 mm ²	4 mm ²	4 mm ²

140..1050 mA

Distance	5 mt	10 mt	20 mt	50 mt
Section	0,25 mm ²	0,25 mm ²	0,5 mm ²	1 mm ²

140..1050 mA dimmable

Distance	5 mt	10 mt	15 mt
Section	0,25 mm ²	0,25 mm ²	0,5 mm ²

FLEXALIGHTING

Flexalighting is part of the group
Italian Design Brands © 2020

Via Lisbona 21
50065 Pontassieve
Firenze, Italy

ph +39.055.83.23.021
fax +39.055.83.24.866

- ▶ info@flexalighting.it
- ▶ www.flexalighting.it

