

/decorative

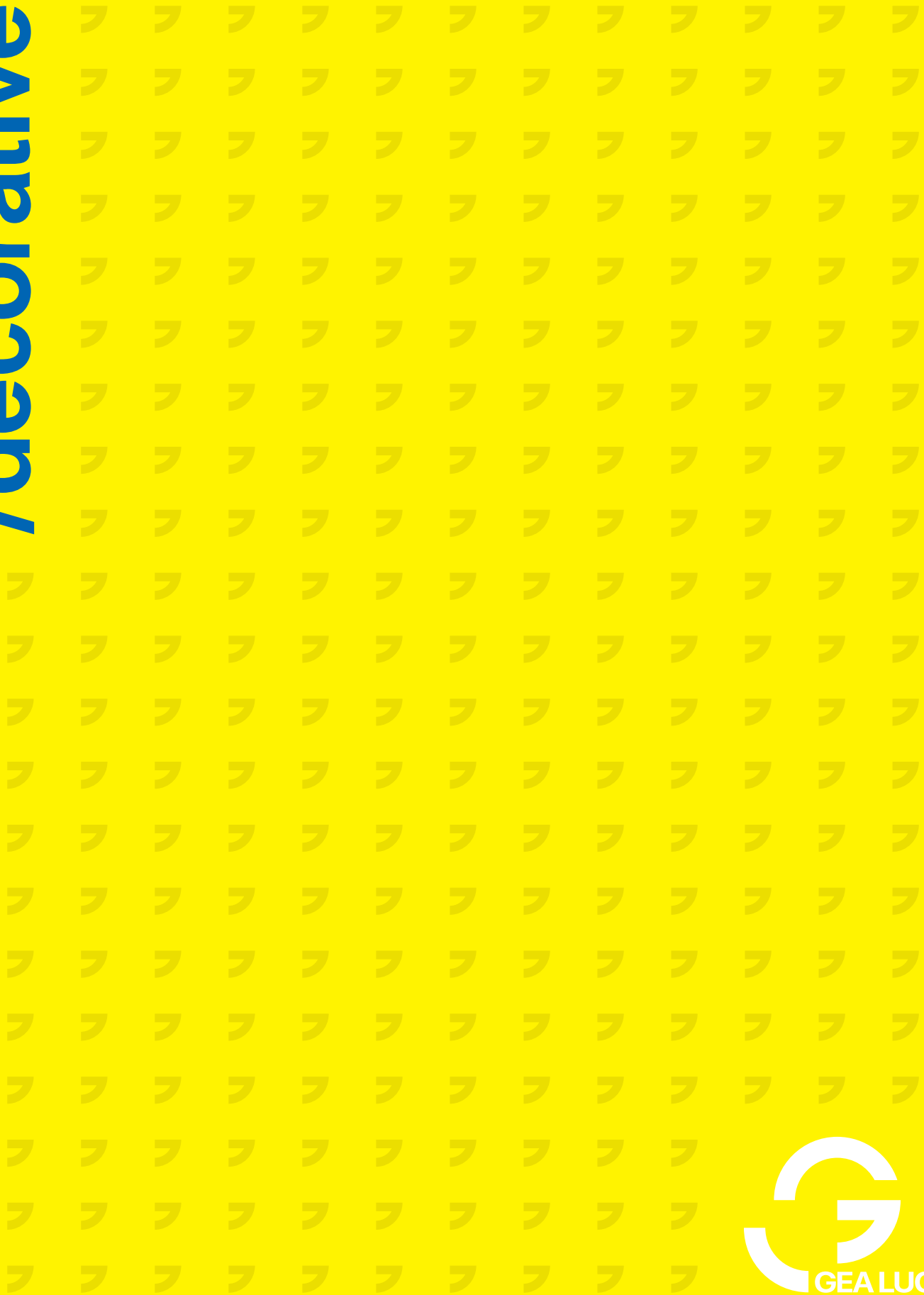



GEA LUCE ILLUMINA IL DESIGN



LA RISPOSTA AL FUTURO
È NELL'INNOVAZIONE /
THE ANSWER TO THE FUTURE
IS INNOVATION



Gea Luce è un'azienda con un know-how consolidato nel campo dell'illuminazione, forte di un'esperienza pluridecennale che da sempre produce apparecchi all'avanguardia, dove design, stile e tecnologia sono un tutt'uno. Una storia di famiglia che vede uniti tre fratelli - Enrico, Antonio e Lucia - nel far crescere e consolidare un progetto comune ed ambizioso: la produzione di soluzioni per l'illuminazione che sfruttano le più moderne tecnologie, come quella LED, per offrire sempre la luce giusta in ogni situazione e per ogni ambiente. Un'azienda che guarda sempre al futuro e alle opportunità che questo sa regalare, un'azienda pronta a raccogliere le sfide e a trasformarle in modi nuovi di esprimere la luce.

La luce del futuro è in continua evoluzione. GEA LUCE ne anticipa le tendenze, rispondendo con nuove proposte e soluzioni inedite. Alla base di ogni progetto c'è un condensato di tecnologia che soddisfa le più moderne richieste del mercato, come la riduzione dei consumi, alte prestazioni, prodotti eco sostenibili, facili da installare e dalla lunga durata. Per vivere la luce senza pensieri. Ma modernità significa anche colore, energia e stile. Per questo le nuove linee GEA LUCE si vestono con materiali che spaziano dal metallo al vetro e abbracciano forme sempre originali, design accattivanti, dove la semplicità è sinonimo di eleganza. GEA LUCE è prospettiva, è visione, è futuro, per darti sempre la migliore illuminazione: funzionale e con stile

GEA LUCE si rinnova, mantenendo la sua identità. Un LOGO nuovo, una nuova veste grafica, un'immagine moderna e coerente che proietta il marchio verso il futuro, simbolo dell'intesa che lega i tre fratelli in questa mission aziendale uniti dalla stessa visione dove la luce è espressione di tecnologia e stile. Il Marchio GEA LUCE è unione ma è anche apertura al futuro, fatto di concretezza, idee semplici e forti, capaci di regalarci sempre nuove soluzioni nel mondo dell'illuminazione.

Gea Luce is a company with well-established expertise in the lighting sector, based on decades of experience in producing cutting-edge fixtures, combining design, style and technology. A family story that brought together three brothers - Enrico, Antonio and Lucia - to develop and consolidate an ambitious joint project: the production of lighting solutions that harness the most modern technologies, such as LED technology, to create the perfect light for every situation and every environment. A company that always looks to the future and to the opportunities it offers, a company ready to face challenges and transform them into new ways of expressing light.

The light of the future is continuously being transformed. GEA LUCE predicts trends, presenting new proposals and unprecedented solutions. At the base of each project lies a synthesis of technology that meets the most modern market demands, such as reduced consumption and high-performance, easy-to-install and long-lasting eco-friendly products. Experience light without a second thought. But modernity also means colour, energy and style. This is why the new GEA LUCE product lines are equipped with materials ranging from metal to glass and always embrace original shapes and attractive designs, in which simplicity is synonymous with elegance. GEA LUCE represents perspective, vision, and the future. We want to always bring you the best lighting that combines functionality with style.

GEA LUCE renews itself and evolves while maintaining its identity. A new LOGO, up-to-date graphics, a modern and coherent image that launches the brand towards a new frontier, a symbol of the mutual understanding that Enrico, Antonio and Lucia renew in this corporate mission, united by the same vision where lighting continues to be experienced as an expression of technology and style. The new GEA LUCE brand represents union but also openness to the future. A future built on pragmatism, simple and strong ideas, creating a new way of experiencing light.

ADELA.360/AFRODITE.154
AGNESE.404/AIDA.348/ALICE COMPOSIZIONI.190
ALICE.184/AMINA.240/ANTEA.246
ARIA.310/BARBIE.232/BERTA.126
BILBAO.306/BLANCA.228/BONELLA.224
BRUNA.236/CAMILLA.398/CINZIA.142/CLEOFE.200
CORPI ILLUMINANTI.20/DAFNE.28
DIVA.82/DOHA.316/DUNA.180/EDITH.168
ELBA.214/EMILY.176/ESTER.214/EVELINE.134
FABIANA.210/FILLY.162/FIRENZE.12
FLASH, FLIP, FLUTE COMPOSIZIONI.52
FLASH, FLIP, FLUTE.48/FRIDA.376
GAETA.16/GISELLE.296/GRACE.328/GUYA.40
HELENA.36/IOLE.92/IRENE.278
ISOTTA.290/JADE.172/KATRINE.130/KRIZIA.112
LAMPADINE DECORATIVE.74
LARA.382/LECCE.372/LUNA.284
MAGIS.264/MANILA.270/MELANIA.138
MICHELA.368/NEKKAR.332
NEREIDE.412/NICOLE.108/NUNKI.334/OLIMPIA.302
ONE.260/PENELOPE, CAMILLA, AGNESE.388
PENELOPE.390/PING-PONG.336/POINT.70
POLAR.256/RING.252/SFERA.218
SISTEMI A BINARIO.10/SOLE.274/SUELO.356
TARA.352/TESSA.150/TOSCA.146
TULLIA.158/VELIA.364/YARA.120
YPSILON.340/ZAIRA.344

Suspension lamps /

LAMPADE A SOSPENSIONE



AGNESE 404



AIDA 348



ALICE 184



AMINA 240



ANTEA 246



BARBIE 232



BLANCA 228



BONELLA 224



BRUNA 236



CAMILLA 398



CINZIA 142



CLEOFE 200



DAFNE 28



DIVA 82



EDITH 168



ELBA 214



EMILY 176



ESTER 214



FABIANA 210

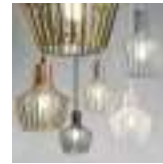

FILLY 162

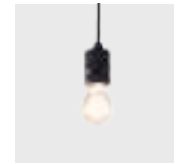

FLASH 48



FLIP 48



FLUTE 48



GISELLE 296



GUYA 40



HELENA 36



IOLE 92



IRENE 278



ISOTTA 290



JADE 172



KRIZIA 112

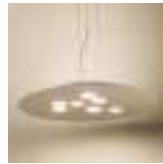

LUNA 284



NEREIDE 412



PENELOPE 390



SFERA 218



SOLE 274



YARA 120

Ceiling lamps /

LAMPADE A SOFFITTO



AFRODITE 154



AGNESE 404



AIDA 348



ANTEA 246



ARIA 310



BERTA 126



BILBAO 306

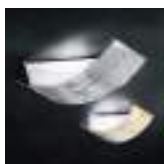

CAMILLA 398



DIVA 82



DOHA 316



DUNA 180



EMILY 176



EVELINE 134



FRIDA 376



GISELLE 296



GRACE 328



IRENE 278



ISOTTA 290



KATRINE 130



KRIZIA 112



LARA 382



LECCE 372



LUNA 284



MANILA 270



MELANIA 138



MICHELA 368



NEREIDE 412



OLIMPIA 302



PENELOPE 390



POINT 70

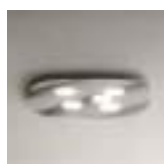

SOLE 274



TESSA 150

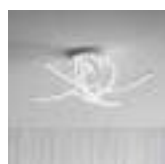

TOSCA 146



TULLIA 158



YARA 120

Wall lamps /

LAMPADE A PARETE



ADELA 360

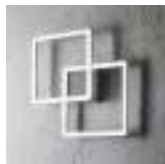

AFRODITE 154



AGNESE 404

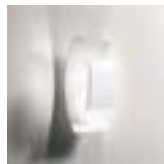

ARIA 310



BERTA 126



CAMILLA 398

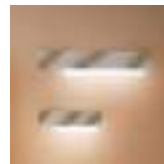

DOHA 316

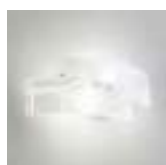

FRIDA 376

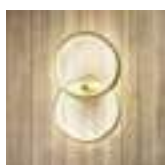

KATRINE 130

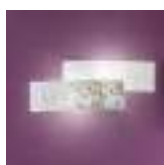

LARA 382



LECCE 372

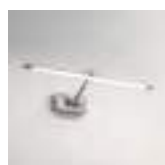

MAGIS 264



MICHELA 368



NEREIDE 412



ONE 260



PENELOPE 390



POINT 70

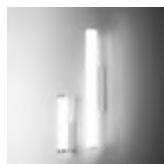

POLAR 256



RING 252



TOSCA 146

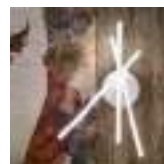

TULLIA 158

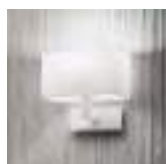

VELIA 364

Floor lamps /

LAMPADE DA TERRA

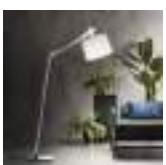

ADELA 360



BERTA 126



IOLE 92



PING-PONG 336



SUELO 356



TARA 352

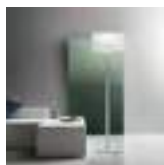

VELIA 364



YPSILON 340



ZAIRA 344

Table lamps /

LAMPADE DA TAVOLO



AGNESE 404



CAMILLA 398



DIVA 82



IOLE 92



NICOLE 108



NEKKAR 332



NEREIDE 412



NUNKI 334



PENELOPE 390



TARA 352



VELIA 364



ZAIRA 344

Track systems /

SISTEMI A BINARIO

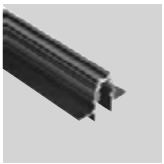

FIRENZE 12

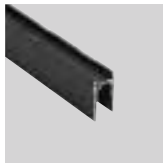

GAETA 16



GENOVA 20



GORIZIA 20

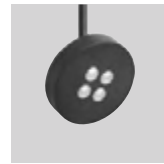

JESI 21



LIVORNO 21



LORETO 21



MODENA 20



NARDÒ 20



NARDÒ 21



SISTEMI A BINARIO IN BASSA TENSIONE 48 VOLT

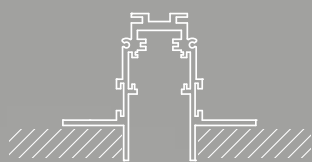

FIRENZE

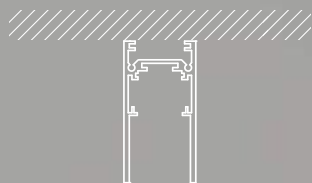

GAETA

I sistemi a bassissima tensione FIRENZE e GAETA, realizzati con profili magnetici permettono un facile alloggiamento di apparecchi di illuminazione lineari, proiettori e luci a sospensione installabili in qualsiasi punto del binario.

I nostri sistemi binario offrono la massima sicurezza perché protetti contro la scarica elettrica per effetto della bassissima tensione che evita il formarsi delle pericolose correnti di contatto. I sistemi a binario elettrificati a bassa tensione sono disponibili nelle varianti da incasso o di superficie.

The ultra low voltage FIRENZE and GAETA systems, built with magnetic profiles, can easily fit linear lighting fixtures, floodlights, and pendant lights, which can be installed anywhere on the track. Our track systems offer maximum safety.

Their ultra low voltage avoids electrical discharge and the formation of dangerous contact currents. Low-voltage electrified track systems are available in recessed or surface versions.

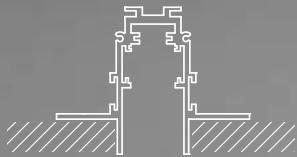
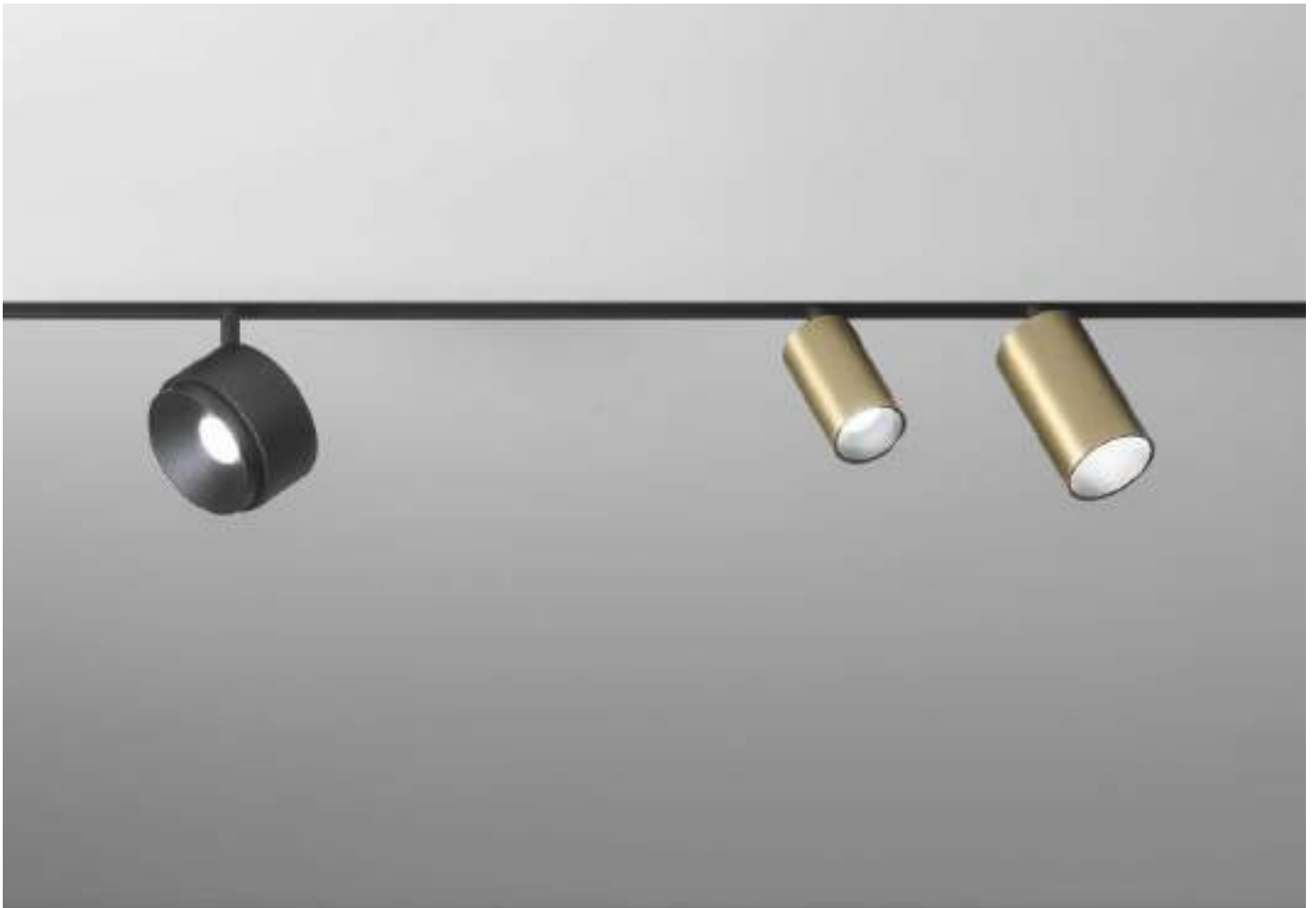

FIRENZE

SISTEMA BINARIO MAGNETICO 48 VOLT DA INCASSO

Il binario da incasso permette un'integrazione totale con l'architettura dell'ambiente indoor grazie al suo design moderno, minimalista, sobrio. Il binario da incasso si può installare a controparete o controsoffitto in cartongesso con spessore da 12,5 mm.

Con il binario magnetico da incasso si possono realizzare una infinità di soluzioni per l'illuminazione degli spazi interni con la raffinatezza e la discrezione di un sistema dall'effetto architettonico sorprendente.

Recessed tracks allow total integration with the architecture of the indoor environment thanks to their modern, minimalist, sober design. Recessed tracks can be installed on a false wall or false plasterboard ceiling with a thickness of 12.5 mm. Using recessed magnetic tracks, you can create endless solutions for lighting interior spaces, with the refinement and discretion of a system that offers a surprising architectural effect.





FACILE, VERSATILE, FANTASIOSO

Disegna sentieri luminosi, utilizzando specifici accessori grazie ai quali potrai raggiungere angoli o posizioni a te gradite collegando in un'unica linea continua le pareti con il soffitto, permettendo di posizionare a piacere i punti luce. Con il sistema binario magnetico da incasso avrai sempre la possibilità di modificare nel tempo la posizione delle sorgenti e creare sempre nuovi scenari luminosi.

Design light paths using specific accessories to reach the desired corners or positions, connecting walls with the ceiling in a single continuous line to produce your preferred lighting arrangement. The recessed magnetic track system allows changing the lighting configuration anytime to produce entirely new lighting scenarios at will.



Corpi Illuminanti /
Corpi Illuminanti

1. Gorizia
2. Genova
3. Nardò
4. Modena
5. Jesi
6. Livorno
7. Loreto
8. Nardò

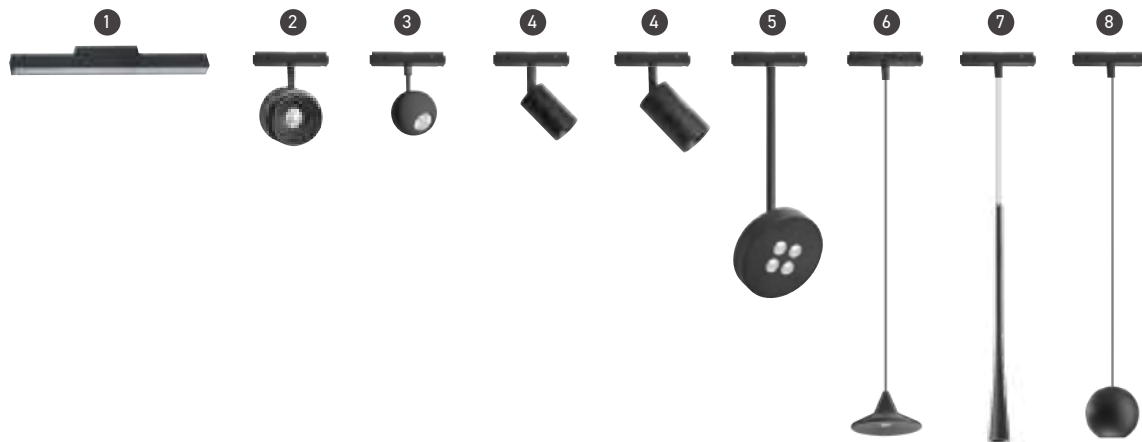

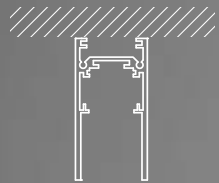

GAETA

BINARIO MAGNETICO 48 VOLT DI SUPERFICIE

Il binario di superficie con l'installazione adossata è la soluzione per gli ambienti in cui non è presente o non si può utilizzare il rivestimento in cartongesso. Con questi presupposti il sistema binario di superficie diventa assoluto interprete e protagonista dello spazio con una presenza dal design rigoroso, fortemente deciso, particolarmente moderno.

Surface tracks with attached installation are designed for environments without or with unsuitable plasterboard cladding. In this context, the surface track system, with its rigorous, marked, and particularly modern design, becomes the space's absolute interpreter and protagonist.





SMART, AGEVOLE, SEMPLICE

Spazio alla creatività, progetta e configura un percorso di luci alternativo, speciale, personalizzato dove inserire luci dal design pulito, minimalista, essenziale con forme e colori diversi, che ben si prestano a coesistere in maniera armonica e funzionale, rendendo l'architettura dei tuoi interni unica e ricercata.

As a tool for creativity, the system serves to design and configure an alternative, special, and personalised lighting path, where you can insert lights with a clean, minimalist, essential design featuring diverse shapes and colours. A visual variety that blends in naturally, in a harmonious and functional way, making your interior spaces unique and sophisticated.



Corpi Illuminanti /
Corpi Illuminanti

1. Gorizia
2. Genova
3. Nardò
4. Modena
5. Jesi
6. Livorno
7. Loreto
8. Nardò

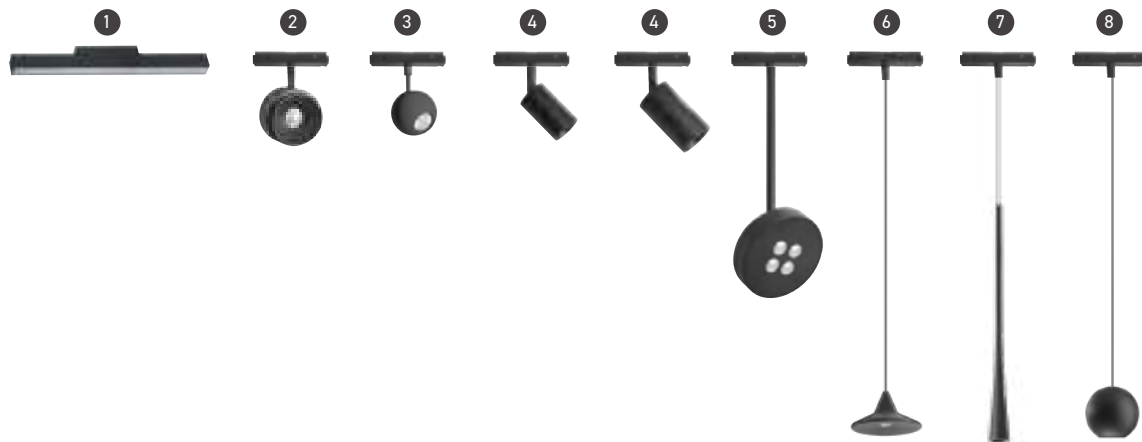

APPARECCHI LUMINOSI

GORIZIA

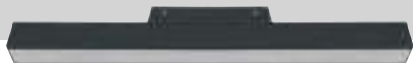

GENOVA



NARDO'



MODENA

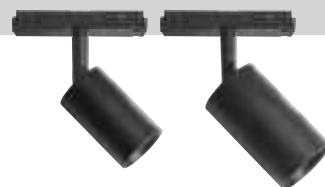

Si possono inserire ed installare a binario, prodotti d'illuminazione di tipo lineare, spot proiettori, ed articoli a sospensione con una semplice pressione sulle due estremità dell'adattatore. Si possono far scorrere i prodotti fino al punto desiderato del binario con la massima sicurezza. Una gamma eterogenea di prodotti d'illuminazione con diverse specifiche e caratteristiche d'illuminazione: dalla luce d'accento alla luce diffusa, apparecchi che sapranno soddisfare qualsiasi esigenza di stile, forma e funzione.

Lighting tracks can fit linear lighting products, spotlights, floodlights, and pendant lamps - all inserted and installed by simply pressing the two ends of the adapter. Slide the products to the desired track point with maximum safety. A broad range of lighting products with different specifications and features: from accent lighting to diffused lighting, luminaires to meet any style, shape and functional requirement.



Bianco/White



Nero/Black



Bianco/White



Nero/Black



Bianco/White



Nero/Black



Oro/Gold



Cromo/Chrome



Rame/Copper



Bianco/White



Nero/Black



Oro/Gold



Cromo/Chrome

JESI

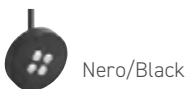
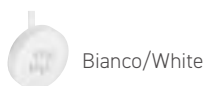

LIVORNO



LORETO



NARDÒ

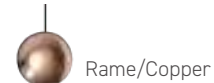
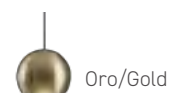
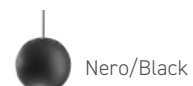

TECHNICAL INFORMATION

Modulo di illuminazione LED lineare a luce diffusa. Sistema ad incastro magnetico installabile nei binari 48V. Non è possibile installare il corpo illuminante negli angoli.

Finiture: bianco o nero opaco.

Linear LED lighting module with diffused light.

Magnetic interlocking system that can be installed in 48V tracks.

It is not possible to install the luminaire in corners.

Finishes: matt white or black.

**GORIZIA RE/P**

Power: **7,2W**
 Input: **48V**
 Lumen: **335Lm**
 Optic: **18°**
 CRI: **>90**
 Light temp.: **3000°K**
 Pack: **0,0013 m³**

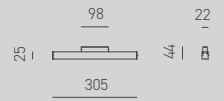
**GORIZIA RE/M**

Power: **14,4W**
 Input: **48V**
 Lumen: **732Lm**
 Optic: **18°**
 CRI: **>90**
 Light temp.: **3000°K**
 Pack: **0,0025 m³**

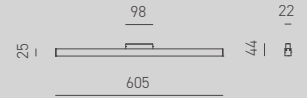
**GORIZIA RE/G**

Power: **28,8W**
 Input: **48V**
 Lumen: **1280Lm**
 Optic: **18°**
 CRI: **>90**
 Light temp.: **3000°K**
 Pack: **0,0049 m³**

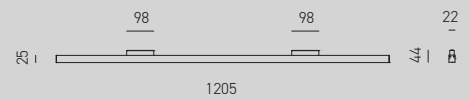

Modulo di illuminazione LED con rotazione ed inclinazione regolabile.

Sistemi ad incastro magnetico installabile nei binari 48V. Non è possibile installare il corpo illuminante negli angoli.

Finiture Genova: bianco o nero opaco.

Finiture Nardò: bianco o nero opaco, rame, oro o cromo.

Finiture Modena: bianco o nero opaco, oro o cromo /

LED lighting module with adjustable rotation and inclination.

Magnetic interlocking system that can be installed in 48V tracks.

It is not possible to install the luminaire in corners.

Finishes Genova: matt white or black.

Finishes Nardò: matt white or black, copper, gold or chrome.

Finishes Modena: matt white or black, gold or chrome.

**GENOVA SP**

Power: **8,5W**
 Input: **48V**
 Lumen: **410Lm**
 CRI: **>90**
 Light temp.: **3000°K**
 Pack: **0,0046 m³**

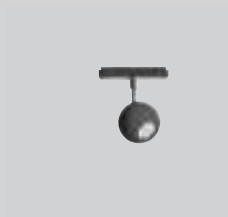
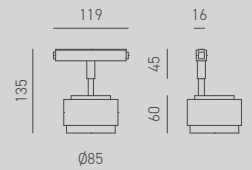
**NARDÒ SP**

Power: **8,5W**
 Input: **48V**
 Lumen: **410Lm**
 CRI: **>90**
 Light temp.: **3000°K**
 Pack: **0,0019 m³**

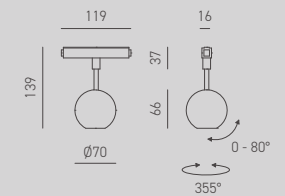
**MODENA SP/P**

Power: **8W**
 Input: **48V**
 Lumen: **502Lm**
 Optic: **24°**
 CRI: **>90**
 Light temp.: **3000°K**
 Pack: **0,0021 m³**

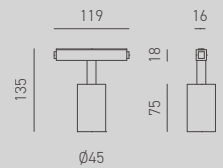

TECHNICAL INFORMATION

Modulo di illuminazione LED con rotazione ed inclinazione regolabile. Sistema ad incastro magnetico installabile nei binari 48V.

Non è possibile installare il corpo illuminante negli angoli. Finiture Modena: bianco o nero opaco, oro o cromo. Finiture Jesi: bianco o nero opaco /

LED lighting module with adjustable rotation and inclination.

Magnetic interlocking system that can be installed in 48V tracks.

It is not possible to install the luminaire in corners.

Finishes Modena: matt white or black, gold or chrome.

Finishes Jesi: matt white or black

**MODENA SP/G**

Power: **15W**
 Input: **48V**
 Lumen: **970Lm**
 Optic: **24°**
 CRI: **>90**
 Light temp.: **3000°K**
 Pack: **0,0033 m³**

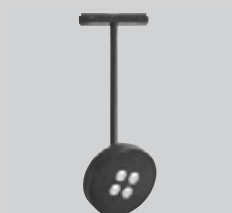
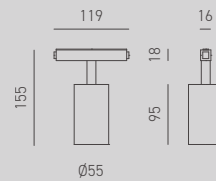
**JESI SP**

Power: **12W**
 Input: **48V**
 Lumen: **915Lm**
 Optic: **38°**
 CRI: **>90**
 Light temp.: **3000°K**
 Pack: **0,0071 m³**

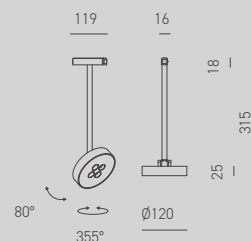

Moduli di illuminazione LED a sospensione con cavo di lunghezza regolabile. Sistema ad incastro magnetico installabile nei binari 48V.

Non è possibile installare il corpo illuminante negli angoli. Finiture Livorno e Loreto: bianco o nero opaco, oro.

Finiture Nardò: bianco o nero opaco, rame, oro o cromo /

Suspended LED lighting modules with adjustable length cable. Magnetic interlocking system that can be installed in

48V tracks.

Finishes Livorno and Loreto: matt white or black, gold.

Finishes Nardò: matt white or black, copper, gold or chrome.

**LIVORNO S**

Power: **7W**
 Input: **48V**
 Lumen: **325Lm**
 Optic: **38°**
 CRI: **>90**
 Light temp.: **3000°K**
 Pack: **0,0018 m³**

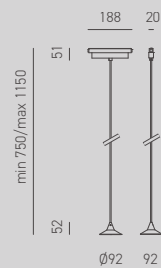
**LORETO S**

Power: **7W**
 Input: **48V**
 Lumen: **213Lm**
 Optic: **38°**
 CRI: **>90**
 Light temp.: **3000°K**
 Pack: **0,0031 m³**

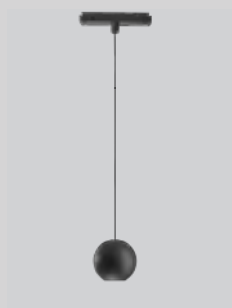
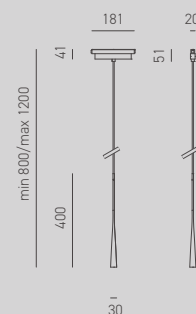
**NARDO' S**

Power: **8,5W**
 Input: **48V**
 Lumen: **410Lm**
 Optic: **36°**
 CRI: **>90**
 Light temp.: **3000°K**
 Pack: **0,0018 m³**

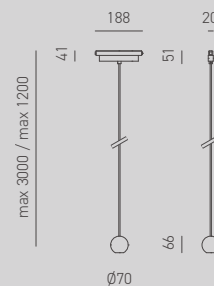

FINISHING

-  Bianco / White
-  Nero / Black
-  Rame / Copper
-  Oro / Gold
-  Cromo / Chrome

TECHNICAL INFORMATION

Sistema a binario modulare elettromeccanico 48V in alluminio sezionabile per installazione ad incasso. Lunghezza 2m.

Finitura: bianco o nero opaco.

Accessori non inclusi /
48V electromechanical modular track system in sectionable aluminium for recessed. Length 2m. Matt white or black finish. Accessories not included.

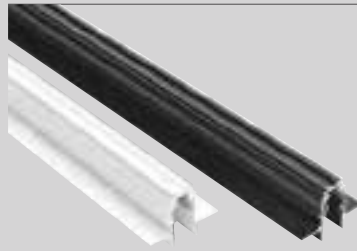
**FIRENZE BI**

Input: **48V**

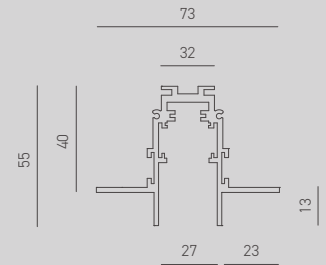

Angolo meccanico a 90° in alluminio per installazione soffitto/soffitto del sistema a binario modulare FIRENZE.

Finitura: bianco o nero opaco /
90° mechanical corner in aluminium for ceiling/ceiling installation of the FIRENZE modular track system. Matt white or black finish.

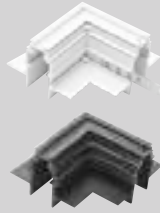
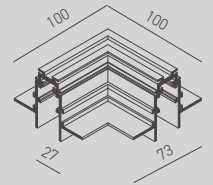
**FIRENZE BI AV**

Angolo meccanico a 90° in alluminio per installazione parete/soffitto del sistema a binario modulare FIRENZE.

Finitura: bianco o nero opaco /
90° mechanical corner in aluminium for wall/ceiling installation of the FIRENZE modular track system. Matt white or black finish.

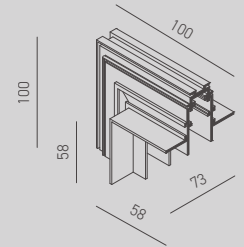
**FIRENZE BI AO**

Giunto lineare in metallo galvanizzato per l'ancoraggio del sistema a binario modulare FIRENZE. Utilizzare 2 staffe per ogni ancoraggio di 2 binari /
Linear joint in galvanised metal for anchoring the FIRENZE modular track system. Use 2 brackets for each 2 track anchor.

**FIRENZE BI ST**

Copertura ad incastro per l'alimentatore ad incastro diretto GAETA TR. Finiture: bianco o nero opaco /

Interlocking cover for the GAETA TR interlocking direct power supply. Finishes: matt white or black.

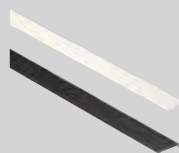
**GAETA COV**

Tappo di chiusura singolo in metallo per sistema a binario modulare FIRENZE.

Finiture: bianco o nero opaco /
Single metal closing cap for FIRENZE modular track system. Finishes: matt white or black.

**FIRENZE BI TA**

TECHNICAL INFORMATION

Sistema a binario modulare elettromeccanico 48V in alluminio sezionabile per installazione di superficie. Lunghezza 2m. Finitura: bianco o nero opaco. Accessori non inclusi / 48V electromechanical modular track system in sectionable aluminium for surface installation. Length 2m. Matt white or black finish. Accessories not included.

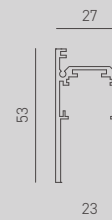
**GAETA BI**Input: **48V**

Angolo meccanico a 90° in alluminio per installazione soffitto/soffitto del sistema a binario modulare GAETA. Finitura: bianco o nero opaco / 90° mechanical corner in aluminium for ceiling/ceiling installation of the GAETA modular track system. Matt white or black finish.

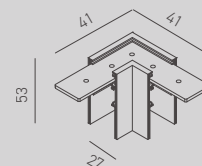
**GAETA BI AV**

Angolo meccanico a 90° in alluminio per installazione parete/soffitto del sistema a binario modulare GAETA. Finitura: bianco o nero opaco / 90° mechanical corner in aluminium for wall/ceiling installation of the GAETA modular track system. Matt white or black finish.

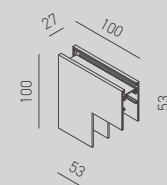
**GAETA BI AO**

Giunto lineare in metallo per l'ancoraggio del sistema a binario modulare GAETA. Utilizzare 1 staffa per ogni ancoraggio di 2 binari. Finitura: bianco o nero opaco / Linear joint in galvanised metal for anchoring the GAETA modular track system. Use 1 bracket for each 2 track anchor. Matt white or black finish.

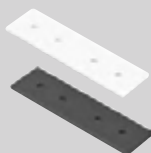
**GAETA BI ST**

Copertura ad incastro per l'alimentatore ad incastro diretto GAETA TR. Finiture: bianco o nero opaco / Interlocking cover for the GAETA TR interlocking direct power supply. Finishes: matt white or black.

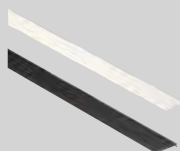
**GAETA COV**

Tappo di chiusura singolo in metallo per sistema a binario modulare GAETA. Finiture: bianco o nero opaco / Single metal closing cap for GAETA modular track system. Finishes: matt white or black.

**GAETA BI TA**

Modulo di connessione elettrica per alimentatori in remoto. Indispensabile per il funzionamento l'alimentatore GAETA TR R1 o GAETA TR R2 /
Electrical connection module for remote power supplies. Indispensable for the operation of the GAETA TR R1 or GAETA TR R2 power supply unit.

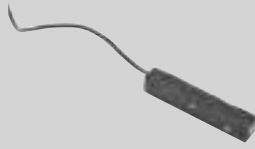
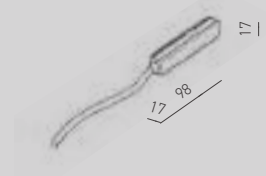
**GAETA CO S**Input: **48V**

Modulo di connessione elettrica di 2 binari FIRENZE o GAETA per installazione lineare o angolare
Finiture: bianco o nero opaco/
Electrical connection module of 2 FIRENZE or GAETA tracks for linear or corner installation.
Finishes: matt white or black.

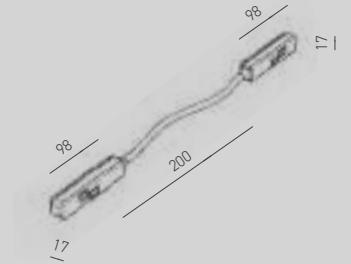
**GAETA CO D**Input: **48V**

Alimentatore ad incastro magnetico diretto per binari FIRENZE o GAETA /
Direct magnetic interlocking power supply for FIRENZE or GAETA tracks.

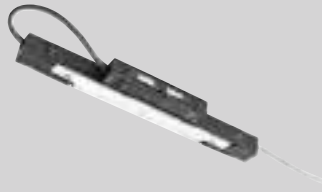
**GAETA TR**

Input
V **220-240V**
A **0,4 A**
Hz **50/60 Hz**
Output
W **60 W**
V **48 V dc**
A **1,25 A**

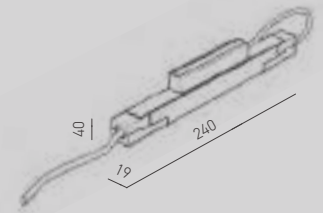

Alimentatore in remoto per binari FIRENZE o GAETA.
Indispensabile per il funzionamento il connettore GAETA CO S /
Remote power supply for FIRENZE or GAETA tracks. The GAETA CO S connector is essential for operation.

**GAETA TR R1**

Input
V **220-240V**
A **350-380 mA**
Hz **50/60 Hz**
Output
W **75 W**
V **48 V dc**
A **1,563 A**

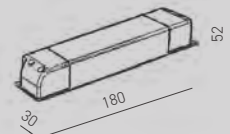

Alimentatore in remoto per binari FIRENZE o GAETA.
Indispensabile per il funzionamento il connettore GAETA CO S /
Remote power supply for FIRENZE or GAETA tracks. The GAETA CO S connector is essential for operation.

**GAETA TR R2**

Input
V **220-240V**
A **550-600 mA**
Hz **50/60 Hz**
Output
W **120 W**
V **48 V dc**
A **2,5 A**

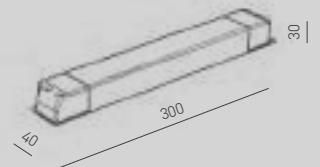

BINARIO MAGNETICO 48 VOLT DA INCASSO

Alimentazione e connessione sono elementi indispensabili per il corretto funzionamento del sistema binario da incasso.

Nelle immagini qui a lato ne raffiguriamo un sintetico e corretto utilizzo.

The power supply unit and the connection are required for the proper operation of the recessed track system. Check the figures on the side for a proper use scheme.



BINARIO MAGNETICO 48 VOLT DI SUPERFICIE

Abbina la miglior soluzione degli alimentatori e delle connessioni in base allo sviluppo ed alla configurazione del tuo sistema binario.

Collega tra loro due o più barre di binario, utilizzando i nostri componenti dedicati, collegando l'alimentazione dalla testa o da qualsiasi altro punto del binario, come illustrato nelle immagini a fianco.

Match the best power supply unit and connection to the development and configuration of your track system. Connect several track bars together using our dedicated components, connecting the power supply unit from the head or from any other track point, as shown in the side figures.





DAFNE

Presente già da un anno nel nostro catalogo DAFNE amplia la sua gamma con la versione ad incasso, oggi sempre molto richiesta. Il suo design longilineo, leggero mai superfluo ci parla di un prodotto minimalista ed essenziale. La sua luce diretta, ma non invasiva assicura un confort visivo ideale per qualsiasi sua installazione. E' disponibile anche come sospensione da binario, per informazioni consultare il catalogo alla pag. 20.

On our catalogue already for a year, DAFNE now adds the recessed version - a very popular option these days - to its range. Its slender, light and always relevant design configures a minimalist and essential product. Its direct but non-invasive light ensures ideal visual comfort on any installation. It is also available as a pendant lamp - for information, consult page 20 on our catalogue.





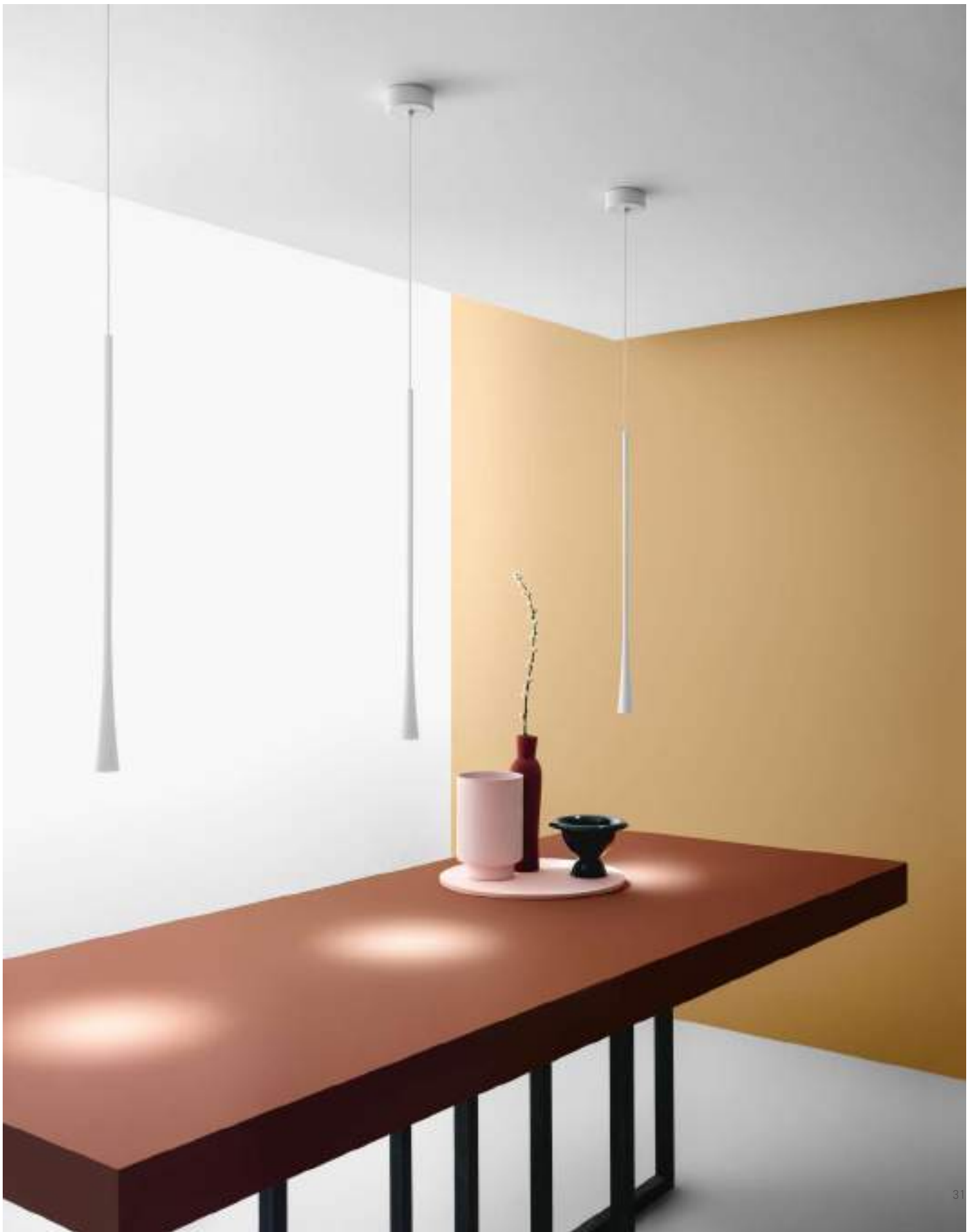

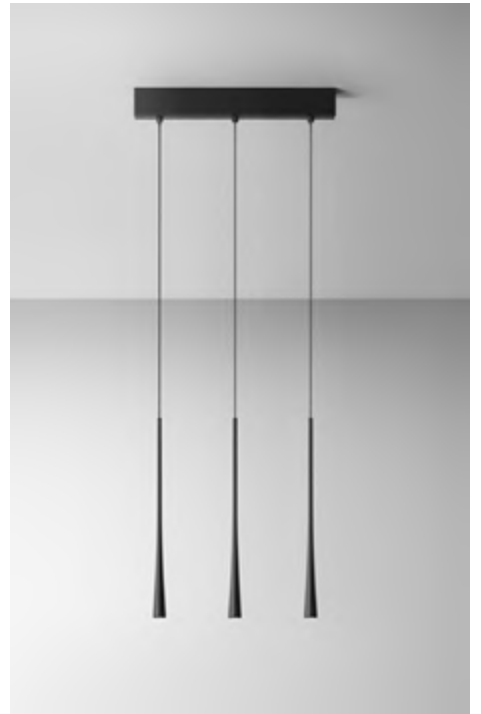





TECHNICAL INFORMATION

Sospensione singola con montatura in alluminio disponibile da incasso o con rosone.
 Sospensione multipla lineare a 3 luci.
 Finiture: bianco satinato con rosone bianco satinato; nero satinato con rosone nero satinato; oro con rosone oro satinato. Sorgente luminosa led ed alimentatore inclusi /
 Single suspension with aluminum frame available as recessed or with canopy. Finishes: satin white rose; satin black with satin black rose; gold with satin black rose.
 LED light source and driver included

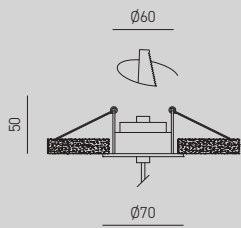
**DAFNE SP/I**

Socket: **1 modulo LED**
 Power: **max 7W**
 input: **220/240V**
 Lumen: **213Lm**
 Optic: **38°**
 CRI: **>90**
 Light temp.: **3000°K**
 Pack: **0,008 m³**

**DAFNE S/P**

Socket: **1 modulo LED**
 Power: **max 7W**
 input: **220/240V**
 Lumen: **213Lm**
 Optic: **38°**
 CRI: **>90**
 Light temp.: **3000°K**
 Pack: **0,003 m³**

**DAFNE S/G**

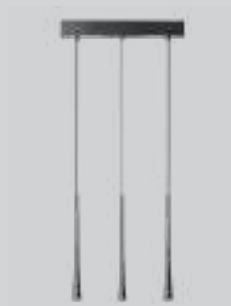

Socket: **1 modulo LED**
 Power: **max 7W**
 Input: **220/240V**
 Lumen: **213Lm**
 Optic: **38°**
 CRI: **>90**
 Light temp.: **3000°K**
 Pack: **0,005 m³**

**DAFNE S/3P**

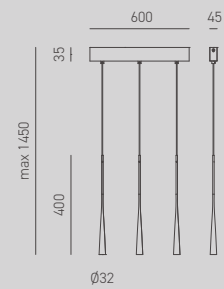
Socket: **3 moduli LED**
 Power: **max 16,5W**
 input: **220/240V**
 Lumen: **612Lm**
 Optic: **38°**
 CRI: **>90**
 Light temp.: **3000°K**
 Pack: **0,008 m³**



FINISHING

-  Bianco Satinato - Bianco Satinato
Satin White - Satin White
-  Nero Satinato - Nero Satinato
Satin Black - Satin Black
-  Oro - Nero Satinato
Gold - Satin Black





HELENA

Una piccola sospensione miniaturizzata, una grande anima luminosa che saprà caratterizzarle i vostri spazi. Il suo design leggero, dalle linee evocative, dal profilo contemporaneo sorprendente ed elegante capace di dialogare ed integrarsi in qualsiasi ambiente. La serie HELENA sino ad oggi presente nelle soluzioni a sospensione singola e multipla 3 luci lineare, si arricchisce oggi con la versione a sospensione da binario a 48 Volt, per informazioni consulta il catalogo a pag. 20.

A small miniaturised pendant light with a large and luminous soul to flood your spaces. Its light design, with evocative lines, with a surprising and elegant contemporary profile capable of communicating and integrating into any environment. The HELENA series, which currently offered single and multiple 3-light linear pendant solutions, has been expanded with the 48 Volt track pendant version - for information, consult page 20 of our catalogue.



TECHNICAL INFORMATION

Sospensioni con montatura in alluminio.
 Finiture: bianco satinato con rosone bianco satinato; nero satinato con rosone nero satinato;
 Sorgente luminosa led ed alimentatore inclusi /
 Suspension lighting with aluminium frame.
 Finishes: satin white with satin white canopy; satin black with satin black canopy;
 LED light source and driver included.

**HELENA S/1**

Socket: **1 modulo LED**
 Power: **max 7W**
 Input: **220/240V**
 Lumen: **325Lm**
 Optic: **38°**
 CRI: **>90**
 Light temp.: **3000°K**
 Pack: **0,002 m³**

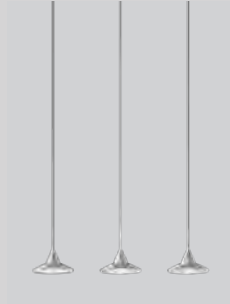
**HELENA S/3**

Socket: **3 moduli LED**
 Power: **max 16,5W**
 Input: **220/240V**
 Lumen: **920Lm**
 Optic: **38°**
 CRI: **>90**
 Light temp.: **3000°K**
 Pack: **0,009 m³**

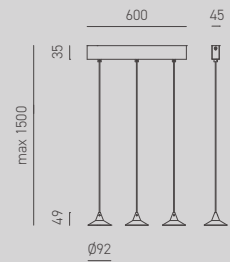

FINISHING



Bianco Satinato - Bianco Satinato
 Satin White - Satin White



Nero Satinato - Nero Satinato
 Satin Black - Satin Black

GUYA

Il suo design soddisfa ogni richiesta di stile contemporaneo o tradizionale grazie ad una forma geometrica praticamente versatile e perfetta. Declinata nelle versioni a sospensione singola o lineare a 3 luci. Anche per questa serie, visto il successo ottenuto, abbiamo incrementato la gamma prodotti, aggiungendo la versione sospensione singola ad incasso. Inoltre troverete la versione spot/proiettore e sospensione da binario in bassa tensione, tutti i particolari da pagina 20 del catalogo.

Its design satisfies any request for contemporary or traditional style thanks to a practically versatile and perfect geometric shape. Available in single or linear pendant versions with 3 lights. Given its popularity, we have also increased the product range for this series, adding the single recessed pendant version. You will also find the spot, floodlight, and pendant version with low-voltage track - further information on page 20 of our catalogue















TECHNICAL INFORMATION

Sospensione singola con montatura in alluminio disponibile da incasso o con rosone.

Sospensione multipla lineare a 3 luci.
Finiture: bianco satinato con rosone bianco satinato; nero satinato con rosone nero satinato; oro con rosone nero satinato.. Sorgente luminosa led ed alimentatore inclusi /

Single suspension with aluminum frame available as recessed or with canopy. Finishes: satin white with satin white canopy; satin black with satin black canopy; gold with satin black canopy.

LED light source and driver included

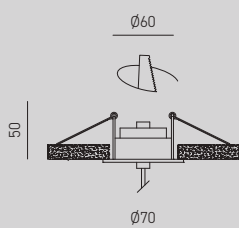

GUYA S/1

Socket: **1 modulo LED**
Power: **max 8,5W**
input: **220/240V**
Lumen: **410Lm**
Optic: **36°**
CRI: **>90**
Light temp.: **3000°K**
Pack: **0,0018 m³**

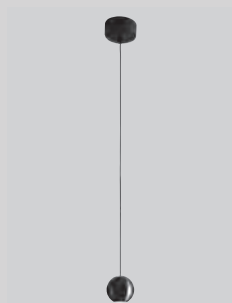
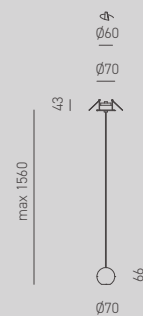

GUYA S/1

Socket: **1 modulo LED**
Power: **max 8,5W**
input: **220/240V**
Lumen: **410Lm**
Optic: **36°**
CRI: **>90**
Light temp.: **3000°K**
Pack: **0,002 m³**

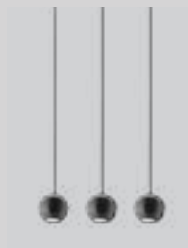
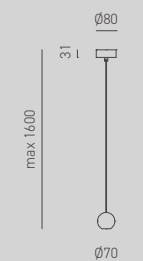

GUYA S/3

Socket: **3 moduli LED**
Power: **max 24W**
input: **220/240V**
Lumen: **1525Lm**
Optic: **36°**
CRI: **>90**
Light temp.: **3000°K**
Pack: **0,007 m³**

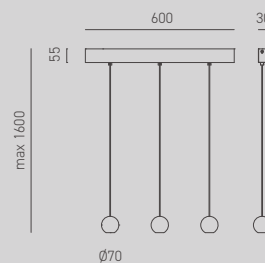

FINISHING

-  Bianco Satinato - Bianco Satinato
Satin White - Satin White
-  Nero Satinato - Nero Satinato
Satin Black - Satin Black
-  Oro - Nero Satinato
Gold - Satin Black



FLASH, FLIP, FLUTE

Sono 3 sospensioni singole, concettualmente simili ma differenti nei dettagli. Un rosone con accessori di fissaggio, cavo elettrico di 2 mt. rivestito in tessuto colorato in abbinamento e 3 montature con portalampade E27 in tinta con il rosone. Uno stile pulito, minimal, industriale composto da pochi elementi da personalizzare e caratterizzare con le lampadine decorative non incluse.

Three single pendant lights with a similar design but different features. Ceiling canopy with fixing accessories, 2m electric cable with matching fabric jacket and 3 frames, with E27 lampholder matching the canopy. Clean, minimal, industrial style consisting of a few elements to be customised and featuring decorative light bulbs - not included.







TECHNICAL INFORMATION

Pendente assemblato con cavo in stoffa 2m, sezione 2x0,75mm. Portalampane E27. Incluso di rosone ed accessori per il fissaggio a sospensione. Lampadina non inclusa. Disponibile nei seguenti colori: Bianco satinato con cavo in stoffa bianco; Nero satinato con cavo in stoffa nero; Ottone con cavo in stoffa oro; Rame con cavo in stoffa marrone; Nickel satinato con cavo in stoffa grigio; Grigio cemento con cavo in stoffa grigio / Pendant mounted with 2m fabric cable, 2x0.75mm section. Lampholder E27. Includes rose and accessories for suspension fitting. Bulb not included.

Available in the following colours: Matt white with white fabric cable; Matt black with black fabric cable; Brass with gold fabric cable; Copper with brown fabric cable; Matt nickel with grey fabric cable; Slate grey with grey fabric cable.

FLUTE



- GS0070** Bianco Satinato/Sand White
- GS0071** Nero Satinato/Sand Black
- GS0072** Ottone/Brass
- GS0073** Rame/Copper
- GS0074** Nickel Satinato/Satin Nickel
- GS0075** Grigio Cemento/Concrete Grey

Socket: **1xE27**
 Power: **max 40W**
 input: **220/240V**
 IP: **20**
 Pack: **0,0010 m³**

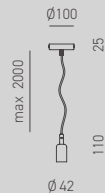

FLIP



- GS0080** Bianco Satinato/Sand White
- GS0081** Nero Satinato/Sand Black
- GS0082** Ottone/Brass
- GS0083** Rame/Copper
- GS0084** Nickel Satinato/Satin Nickel
- GS0085** Grigio Cemento/Concrete Grey

Socket: **1xE27**
 Power: **max 40W**
 input: **220/240V**
 IP: **20**
 Pack: **0,0010 m³**

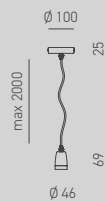

FLASH



- GS0090** Bianco Satinato/Sand White
- GS0091** Nero Satinato/Sand Black
- GS0092** Ottone/Brass
- GS0093** Rame/Copper
- GS0094** Nickel Satinato/Satin Nickel
- GS0095** Grigio Cemento/Concrete Grey

Socket: **1xE27**
 Power: **max 40W**
 input: **220/240V**
 IP: **20**
 Pack: **0,0010 m³**

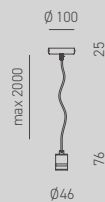

FINISHING

-  Bianco Satinato / Satin White
-  Nero Satinato / Satin Black
-  Ottone / Brass
-  Rame / Copper
-  Nickel Satinato / Satin Nickel
-  Grigio Cemento / Concrete Grey

FLASH, FLIP, FLUTE COMPOSIZIONI

Composizioni che si svelano come preziosi dettagli estetici, dalle linee essenziali che caratterizzano gli spazi rendendoli contemporanei suggestivi e sofisticati. Una miriade di accessori e componenti unitamente ai lunghi cavi elettrici rivestiti di treccia in tessuto colorato che consentono di disegnare delle composizioni indicate a chi vive la casa in modo personale, originale e dinamico.

Compositions that reveal themselves as precious aesthetic details, with essential lines that confer your spaces a contemporary, suggestive and sophisticated personality. Endless accessories and components together with the electric cable with braided fabric jacket. Ideal to design compositions suitable for those enjoying their home in a personal, original and dynamic way.







Composizione con rosone a 12 luci proposto nella configurazione simmetrica circolare con decentratore per cavo a filo muro. Nella pagina accanto la proposta del rosone con un punto luce sempre con decentratore per cavo radente. Lampadine nella versione anti abbagliamento e a semplice filamento led.

12-port ceiling canopy offered in a circular symmetrical configuration with cable hook flush with the wall. The page opposite shows a ceiling canopy with a light point and cable hook. Bulbs in the anti-glare and single LED filament version.

Esempio d'ordine: **GSOB01 n.1 + GS0BL01 n.12 + GSOP70 n.12 + GSOCWS n.1**

Order example: **GSOB01 n.1 + GS0BL01 n.12 + GSOP70 n.12 + GSOCWS n.1**





Composizione con rosone a 5 luci proposto nella configurazione asimmetrica con decentratori con aggancio per cavi, lampadine decorative di varie forme e colorazioni (per dettagli consultare pag.74).

Nella pagina a fianco composizione con 5 luci a cascata in varie altezze.

5-port canopy with asymmetrical configuration, cable hooks, and decorative bulbs of various shapes and colours (for details see page 74). The page opposite shows 5 cascading lights at various heights.

Esempio d'ordine: **GSOB52 n.1 + GSUBL12 n.5 + GSOP92 n.5 + GSOLN2 n.1**

Order example: **GSOB52 n.1 + GSUBL12 n.5 + GSOP92 n.5 + GSOLN2 n.1**





Composizione con rosone a 3 luci proposto nella configurazione simmetrica circolare con decentratori con aggancio per cavi e lampadine decorative di varie forme e colorazioni (per dettagli consultare pag.74). Nella pagina accanto stessa composizione con lampadine globolux a filamento led.
 3-port ceiling canopy with circular symmetrical configuration, cable hooks, and decorative light bulbs of various shapes and colours (for details see page 74). The page opposite shows an identical composition with globolux LED filament bulbs.

Esempio d'ordine: **GSOB30 n. 1 + GSUBL10 n.3 + GSOP70 n.1 + GSOP80 n.1 + GSOP90 n.1 + GSOCW2 n.1**

Order example: **GSOB30 n. 1 + GSUBL10 n.3 + GSOP70 n.1 + GSOP80 n.1 + GSOP90 n.1 + GSOCW2 n.1**





Composizione con rosone lineare a 5 luci proposto con configurazione asimmetrica con decentratori con aggancio per cavi, installazione di lampadine decorative di varie forme e colorazioni (per dettagli consultare pag.74). Nella pagina accanto viene proposta una configurazione lineare con speciali lampadine decorative presenti a pag. 74.

5-port canopy with asymmetrical configuration, cable hooks, installation of decorative bulbs of various shapes and colours (for details see page 74). The page opposite shows a linear configuration with special decorative bulbs on page 74.

Esempio d'ordine: **GSOB24 n.1 + GSOBL14 n.5 + GSOP84 n.5 + GSOCS2 n.1**

Order example: **GSOB24 n.1 + GSOBL14 n.5 + GSOP84 n.5 + GSOCS2 n.1**





Composizione con rosone lineare a 3 luci proposto con configurazione asimmetrica con decentratori con aggancio per cavi, installazione di lampadine decorative di varie forme e colorazioni (per dettagli consultare pag.74). Nella pagina accanto viene proposta una configurazione lineare a 3 luci.

3-port canopy with asymmetrical configuration, cable hooks, and installation of decorative bulbs of various shapes and colours (for details see page 74). The page opposite shows a linear 3-light configuration.

Esempio d'ordine: **GSOB42 n.1 + GSUBL12 n.1 + GSOP72 n.3 + GSOC02 n.1**

Order example: **GSOB42 n.1 + GSUBL12 n.1 + GSOP72 n.3 + GSOC02 n.1**





Composizione singola con rosone a 1 luce proposto nella configurazione asimmetrica con decentratore con aggancio per cavo, lampadina decorativa (per dettagli consultare pag.74).

Nella pagina accanto stessa composizione con lampadina a filamento led.

Single composition with 1-port canopy with asymmetrical configuration, cable hooks, and decorative light bulb (for details see page 74). The page opposite shows the same composition with LED filament bulb.

Esempio d'ordine: **GS0092 n.1 + GS0BL12 n.1**

Order example: **GS0092 n.1 + GS0BL12 n.1**



TECHNICAL INFORMATION

PORTALAMPADE / LAMPHOLDER

Portalampe in metallo con pressacavo incluso. Finiture: Bianco satinato; Nero satinato; Ottone; Rame; Nickel satinato; Grigio cemento / Metal lamp holder with cable gland included. Finishes: satin white; satin black; brass; copper; satin nickel; concrete grey./



GSOP70 Bianco Satinato/Sand White
GSOP71 Nero Satinato/Sand Black
GSOP72 Ottone/Brass
GSOP73 Rame/Copper
GSOP74 Nickel Satinato/Satin Nickel
GSOP75 Grigio Cemento/Concrete Grey

Socket: **1xE27**

Power: **max 40W**

input: **220/240V**

IP: **20**

Pack: **0,00034 m³**



GSOP80 Bianco Satinato/Sand White
GSOP81 Nero Satinato/Sand Black
GSOP82 Ottone/Brass
GSOP83 Rame/Copper
GSOP84 Nickel Satinato/Satin Nickel
GSOP85 Grigio Cemento/Concrete Grey

Socket: **1xE27**

Power: **max 40W**

input: **220/240V**

IP: **20**

Pack: **0,0034 m³**



GSOP90 Bianco Satinato/Sand White
GSOP91 Nero Satinato/Sand Black
GSOP92 Ottone/Brass
GSOP93 Rame/Copper
GSOP94 Nickel Satinato/Satin Nickel
GSOP95 Grigio Cemento/Concrete Grey

Socket: **1xE27**

Power: **max 40W**

input: **220/240V**

IP: **20**

Pack: **0,0034 m³**

**ROSONI RETTANGOLARI / RECTANGULAR CEILING ROSE**

Rosone rettangolare a 3 o 5 fori in metallo con staffa ed accessori per il fissaggio inclusi. Inclusi 3 o 5 pressacavi e morsettiere elettrica. Finiture: Bianco satinato; Nero satinato; Ottone; Rame; Nickel satinato; Grigio cemento / 3 or 5 holes, rectangular metal ceiling rose with bracket and fixing accessories included.

Includes 3 or 5 cable glands and electrical terminal block.

Finishes: Matt white; Matt black; Brass; Copper; Matt nickel; Slate grey.

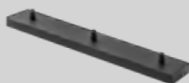

GSOB40 Bianco Satinato/Sand White
GSOB41 Nero Satinato/Sand Black
GSOB42 Ottone/Brass
GSOB43 Rame/Copper
GSOB44 Nickel Satinato/Satin Nickel
GSOB45 Grigio Cemento/Concrete Grey

Pack: **0,00138 m³**

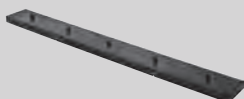
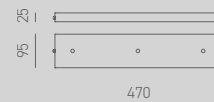

GSOB20 Bianco Satinato/Sand White
GSOB21 Nero Satinato/Sand Black
GSOB22 Ottone/Brass
GSOB23 Rame/Copper
GSOB24 Nickel Satinato/Satin Nickel
GSOB25 Grigio Cemento/Concrete Grey

Pack: **0,00299 m³**



TECHNICAL INFORMATION

Rosone ad 1, 3, 5, 12 fori in metallo con staffa ed accessori per il fissaggio inclusi. Completo di pressacavi e morsettiera elettrica.

Finiture: Bianco satinato; Nero satinato; Ottone; Rame; Nickel satinato; Grigio cemento / 1, 3, 5, 12 hole metal ceiling rose with bracket and fixing accessories included. Includes a cable gland and electrical terminal block. Finishes: Matt white; Matt black; Brass; Copper; Matt nickel; Slate grey.



GSOB10 Bianco Satinato/Sand White
GSOB11 Nero Satinato/Sand Black
GSOB12 Ottone/Brass
GSOB13 Rame/Copper
GSOB14 Nickel Satinato/Satin Nickel
GSOB15 Grigio Cemento/Concrete Grey
 Pack: **0,00039 m³**



GSOB30 Bianco Satinato/Sand White
GSOB31 Nero Satinato/Sand Black
GSOB32 Ottone/Brass
GSOB33 Rame/Copper
GSOB34 Nickel Satinato/Satin Nickel
GSOB35 Grigio Cemento/Concrete Grey
 Pack: **0,00047 m³**



GSOB50 Bianco Satinato/Sand White
GSOB51 Nero Satinato/Sand Black
GSOB52 Ottone/Brass
GSOB53 Rame/Copper
GSOB54 Nickel Satinato/Satin Nickel
GSOB55 Grigio Cemento/Concrete Grey
 Pack: **0,00047 m³**



GSOB01 Bianco Satinato/Sand White
GSOB02 Nero Satinato/Sand Black
GSOB03 Ottone/Brass
GSOB04 Rame/Copper
GSOB05 Nickel Satinato/Satin Nickel
GSOB06 Grigio Cemento/Concrete Grey
 Pack: **0,00103 m³**

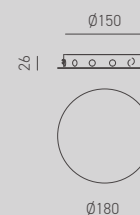

Decentratore in metallo con aggancio e fissaggio con grano per cavi in stoffa 2x0,75mm. Finiture: Bianco satinato; Nero satinato; Ottone; Rame; Nickel satinato; Grigio cemento / Metal decentralizer with hook and dowel fitting for 2x0.75mm fabric cables. Finishes: Matt white; Matt black; Brass; Copper; Matt nickel; Slate grey.



GSOBL10 Bianco Satinato/Sand White
GSOBL11 Nero Satinato/Sand Black
GSOBL12 Ottone/Brass
GSOBL13 Rame/Copper
GSOBL14 Nickel Satinato/Satin Nickel
GSOBL15 Grigio Cemento/Concrete Grey
 Pack: **0,00019 m³**



Decentratore in metallo con regolazione per cavi in stoffa 2x0,75mm. Finiture: Bianco satinato; Nero satinato; Ottone; Rame; Nickel satinato; Grigio cemento / Metal decentraliser with adjustment for 2x0.75mm fabric cables. Finishes: Matt white; Matt black; Brass; Copper; Matt nickel; Slate grey.



GSOBL01 Bianco Satinato/Sand White
GSOBL02 Nero Satinato/Sand Black
GSOBL03 Ottone/Brass
GSOBL04 Rame/Copper
GSOBL05 Nickel Satinato/Satin Nickel
GSOBL06 Grigio Cemento/Concrete Grey
 Pack: **0,00002 m³**





TECHNICAL INFORMATION

Cavo elettrico rivestito in tessuto di sezione 2x0,75mm.

Disponibili in bobine da 20 o 50 metri dei seguenti colori: blu, grigio, marrone, nero, oro, rosso, argento, verde, bianco./

Electric cable covered in fabric with 2x0,75mm section.

Available in 20 or 50 metre reels in the following colors: blue, grey, brown black, gold, red, silver, green, white.

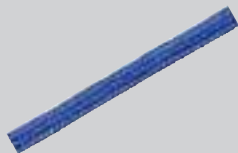
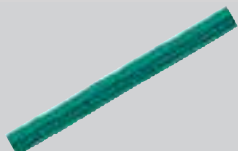
**GSOCB2**Meters: **20**
Finished: **Blu/Blue****GSOCB5**Meters: **50**
Finished: **Blu/Blue****GSOCG2**Meters: **20**
Finished: **Grigio/Grey****GSOCG5**Meters: **50**
Finished: **Grigio/Grey****GSOCM2**Meters: **20**
Finished: **Marrone/Brown****GSOCM5**Meters: **50**
Finished: **Marrone/Brown****GSOCN2**Meters: **20**
Finished: **Nero/Black****GSOCN5**Meters: **50**
Finished: **Nero/Black****GSOC02**Meters: **20**
Finished: **Oro/Gold****GSOC05**Meters: **50**
Finished: **Oro/Gold****GSOCR2**Meters: **20**
Finished: **Rosso/Red****GSOCR5**Meters: **50**
Finished: **Rosso/Red****GSOCS2**Meters: **20**
Finished: **Argento/Silver****GSOCS5**Meters: **50**
Finished: **Argento/Silver****GSOCV2**Meters: **20**
Finished: **Verde/Green****GSOCV5**Meters: **50**
Finished: **Verde/Green****GSOCW2**Meters: **20**
Finished: **Bianco/White****GSOCW5**Meters: **50**
Finished: **Bianco/White**





POINT

Semplicemente minimal, pulita, essenziale. Riconsiderata come punto luce sia da soffitto che da parete, permettere l'alloggiamento di lampadine E27 particolarmente attrattive e decorative, dallo spiccato senso estetico e dalla forte personalità. Disponibile in una importante gamma di colorazioni e finiture cromatiche.

Simply minimal, clean, essential. Suitable as a light point for both ceiling and wall installation; can use the particularly attractive and decorative E27 bulbs, with a strong aesthetic sense and personality. Available in a broad range of colours and chromatic finishes.

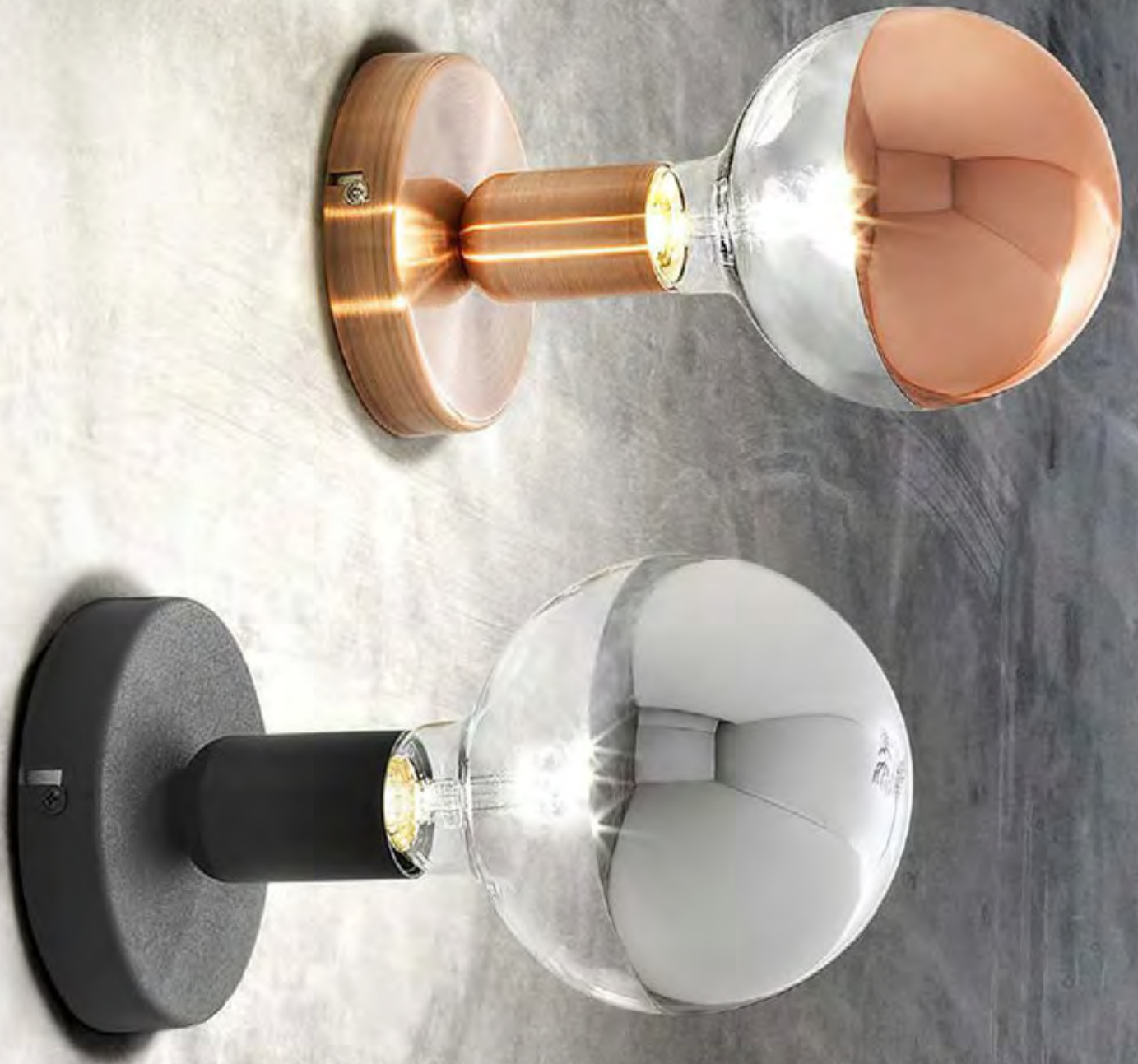

TECHNICAL INFORMATION

Plafone dotato di accessori per il fissaggio. Portalampade E27. Lampadina non inclusa.

Finiture: Bianco satinato; Nero satinato; Ottone; Rame; Nickel satinato; Grigio cemento/

Ceiling lamp equipped with fitting accessories.

Lampholder E27. Bulb not included.

Available finishes: satin white; satin black; brass; copper; satin nickel; concrete grey

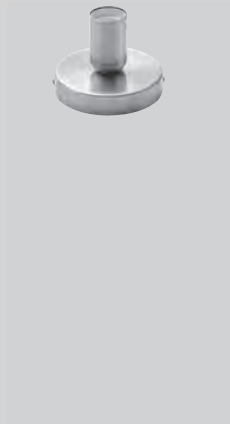

- GSOP01** Bianco Satinato/Sand White
- GSOP02** Nero Satinato/Sand Black
- GSOP03** Ottone/Brass
- GSOP04** Rame/Copper
- GSOP05** Nickel Satinato/Satin Nickel
- GSOP06** Grigio Cemento/Concrete Grey

Socket: **1xE27**
 Power: **max 40W**
 input: **220/240V**
 Pack: **0,0016 m³**

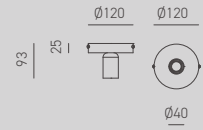

FINISHING

-  Bianco Satinato / Satin White
-  Nero Satinato / Satin Black
-  Ottone / Brass
-  Rame / Copper
-  Nickel Satinato / Satin Nickel
-  Grigio Cemento / Concrete Grey



A collection of decorative filament LED light bulbs hanging from a ceiling. The bulbs are of various shapes and sizes, including teardrop, round, and spiral designs. They are illuminated, casting a warm glow. The background features a large, arched opening in a wall, suggesting a modern interior setting. The overall aesthetic is minimalist and contemporary.

LAMPADINE DECORATIVE CON LED A FILAMENTO

Si propongono come una rivisitazione dell'atmosfera vintage, stilisticamente in armonia tra loro, ma capaci di vivere anche singolarmente. Piacciono per la loro particolarità che le rendono un originale elemento decorativo dalle generose dimensioni, adatte sia per ambienti pubblici che privati, indifferentemente orientate allo stile classico o a quello moderno.

Trovano un ottima collocazione nelle composizioni multiple in abbinamento ai nostri prodotti a sospensione FLASH, FLIP, FLUTE o nella versione a plafoniera POINT.

DECORATIVE LIGHT BULBS.

They are proposed as a reinterpretation of the vintage atmosphere, stylistically in harmony with each other but with their own individual personality. Their popularity arises from their special design, making them original decorative elements of generous dimensions, suitable for both public and private environments, befitting both classic and modern styles. They blend in perfectly in various compositions including our pendant lights FLASH, FLIP, FLUTE or the ceiling version POINT.

TECHNICAL INFORMATION

Lampadine LED decorative di varie forme. Attacco E27. Dimmerabili tramite dimmer esterno + push (non inclusi). Finiture: Ambra trasparente; Fumè trasparente / Decorative LED bulbs of various shapes. E27 fitting. Dimmable via external dimmer + push-button dimmer (not included). Available finishes: transparent amber; transparent smoked.

**GLA400** Ambra/Amber

Socket: **E27**
 Power: **6W**
 input: **220/240V**
 Light temp.: **2700°K**
 Optic: **330°**
 Lumen: **400Lm**
 Hours **25.000**
 CRI: **90**
 Accens.: **15000**

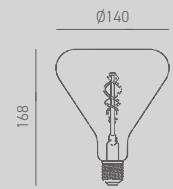
**GLA401** Fumè/Smoke

Socket: **E27**
 Power: **6W**
 input: **220/240V**
 Light temp.: **2700°K**
 Optic: **330°**
 Lumen: **200Lm**
 Hours **25.000**
 CRI: **90**
 Accens.: **15000**

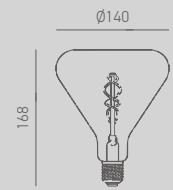
**GLA410** Ambra/Amber

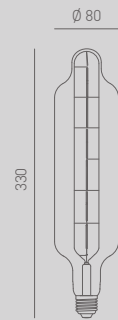

Socket: **E27**
 Power: **8W**
 input: **220/240V**
 Light temp.: **2700°K**
 Optic: **330°**
 Lumen: **800Lm**
 Hours **25.000**
 CRI: **80**
 Accens.: **15000**

**GLA411** Fumè/Smoke

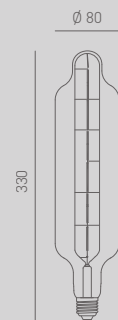
Socket: **E27**
 Power: **8W**
 input: **220/240V**
 Light temp.: **2700°K**
 Optic: **330°**
 Lumen: **400Lm**
 Hours **25.000**
 CRI: **80**
 Accens.: **15000**



FINISHING

-  Ambrato / Amber
-  Fumè / Smoked

**GLA420** Ambra/Amber

Socket: **E27**
 Power: **8W**
 input: **220/240V**
 Light temp.: **2700°K**
 Optic: **330°**
 Lumen: **800Lm**
 Hours **25.000**
 CRI: **80**
 Accens.: **15000**

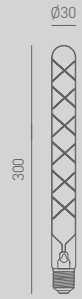
**GLA421** Fumè/Smoke

Socket: **E27**
 Power: **8W**
 input: **220/240V**
 Light temp.: **2700°K**
 Optic: **330°**
 Lumen: **400Lm**
 Hours **25.000**
 CRI: **80**
 Accens.: **15000**

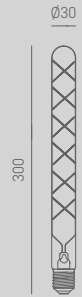
**GLA430** Ambra/Amber

Socket: **E27**
 Power: **6W**
 input: **220/240V**
 Light temp.: **2700°K**
 Optic: **330°**
 Lumen: **400Lm**
 Hours **25.000**
 CRI: **90**
 Accens.: **15000**

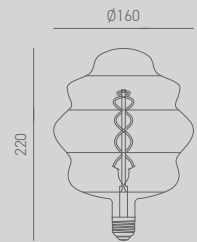
**GLA431** Fumè/Smoke

Socket: **E27**
 Power: **6W**
 input: **220/240V**
 Light temp.: **2700°K**
 Optic: **330°**
 Lumen: **200Lm**
 Hours **25.000**
 CRI: **90**
 Accens.: **15000**

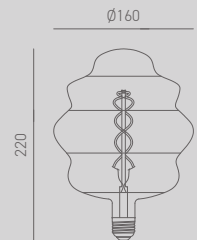

TECHNICAL INFORMATION

Lampadine LED decorative di varie forme. Attacco E27. Dimmerabili tramite dimmer esterno + push (non inclusi). Finiture: Ambra trasparente; Fumè trasparente. GLA472 disponibile anche trasparente / Decorative LED bulbs of various shapes. E27 fitting. Dimmable via external dimmer + push-button dimmer (not included).

Available finishes: transparent amber; transparent smoked. GLA472 also available in a transparent version

**GLA440** Ambra/Amber

Socket: **E27**
 Power: **6W**
 input: **220/240V**
 Light temp.: **2700°K**
 Optic: **330°**
 Lumen: **400Lm**
 Hours **25.000**
 CRI: **90**
 Accens.: **15000**

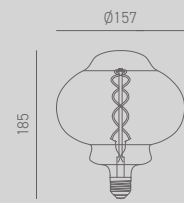
**GLA441** Fumè/Smoke

Socket: **E27**
 Power: **6W**
 input: **220/240V**
 Light temp.: **2700°K**
 Optic: **330°**
 Lumen: **200Lm**
 Hours **25.000**
 CRI: **90**
 Accens.: **15000**

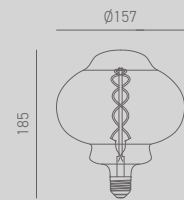
**GLA450** Ambra/Amber

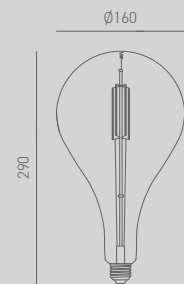

Socket: **E27**
 Power: **8W**
 input: **220/240V**
 Light temp.: **2700°K**
 Optic: **330°**
 Lumen: **800Lm**
 Hours **25.000**
 CRI: **80**
 Accens.: **15000**

**GLA451** Fumè/Smoke

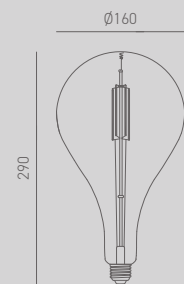
Socket: **E27**
 Power: **8W**
 input: **220/240V**
 Light temp.: **2700°K**
 Optic: **330°**
 Lumen: **400Lm**
 Hours **25.000**
 CRI: **80**
 Accens.: **15000**



FINISHING

-  Ambrato / Amber
-  Fumè / Smoked
-  Trasparente / Clear

	<p>GLA460 Ambra/Amber</p> <p>Socket: E27 Power: 8W input: 220/240V Light temp.: 2700°K Optic: 330° Lumen: 800Lm Hours 25.000 CRI: 80 Accens.: 15000</p>	
	<p>GLA461 Fumè/Smoke</p> <p>Socket: E27 Power: 8W input: 220/240V Light temp.: 2700°K Optic: 330° Lumen: 400Lm Hours 25.000 CRI: 80 Accens.: 15000</p>	
	<p>GLA470 Ambra/Amber</p> <p>Socket: E27 Power: 8W input: 220/240V Light temp.: 2700°K Optic: 330° Lumen: 780Lm Hours 25.000 CRI: 80 Accens.: 15000</p>	
	<p>GLA471 Fumè/Smoke</p> <p>Socket: E27 Power: 8W input: 220/240V Light temp.: 2700°K Optic: 330° Lumen: 400Lm Hours 25.000 CRI: 80 Accens.: 15000</p>	
	<p>GLA472 Trasparente/Clear</p> <p>Socket: E27 Power: 8W input: 220/240V Light temp.: 2700°K Optic: 330° Lumen: 800Lm Hours 25.000 CRI: 80 Accens.: 15000</p>	









DIVA

Materia leggera, figura ariosa, linee fluttuanti ed armoniose. DIVA è autentico design dettato dalla sua forma organica, che dà vita ad un prodotto di luce avvolgente e virtuoso. Abbiamo arricchito la gamma con una sospensione dalle dimensioni generose e da una lampada a plafoniera. Alle due precedenti ed eleganti finiture in oro satinato e bianco si aggiunge ora la nuova colorazione Titanio.

Lightweight material, airy silhouette, harmonious lines. Diva conveys pure design with its organic form to create an enveloping and virtuous path of light. We have expanded the range with a generously sized pendant light and a ceiling lamp. We have added the titanium colour to the elegant satin gold and white finishes.















TECHNICAL INFORMATION

Montatura in alluminio bianco satinato, oro spazzolato o titanio.
 Diffusore in silicone bianco opale.
 Sorgente luminosa led; dimmerabile tramite dimmer esterno + push (non inclusi).
 Lume dimmerabile tramite dimmer integrato nel cablaggio /
 Frame in satin white aluminum, brushed gold or titanium.
 Opal white silicone diffuser.
 LED light source; dimmable via external dimmer + push-button dimmer (not included).
 Lamp with inline cord dimmer.

**DIVA S/P**

Socket: **1 modulo LED**
 Power: **max 39W**
 input: **220/240V**
 Lumen: **1950Lm**
 CRI: **>80**
 Light temp.: **3000°K**
 Pack: **0,051 m³**

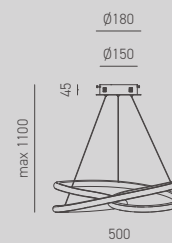
**DIVA S/G**

Socket: **1 modulo LED**
 Power: **max 47W**
 input: **220/240V**
 Lumen: **2350Lm**
 CRI: **>80**
 Light temp.: **3000°K**
 Pack: **0,099 m³**

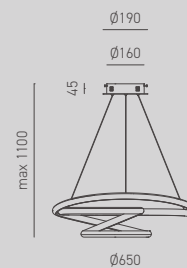
**DIVA S/S**

Socket: **1 modulo LED**
 Power: **max 80W**
 input: **220/240V**
 Lumen: **4800Lm**
 CRI: **>80**
 Light temp.: **3000°K**
 Pack: **0,267 m³**

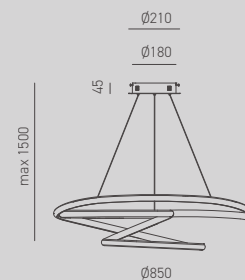
**DIVA P/P**

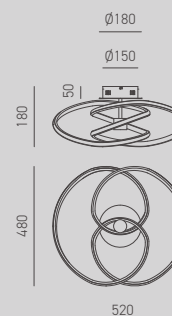

Socket: **1 modulo LED**
 Power: **max 40W**
 input: **220/240V**
 Lumen: **2500Lm**
 CRI: **>80**
 Light temp.: **3000°K**
 Pack: **0,072 m³**

**DIVA L**

Socket: **1 modulo LED**
 Power: **max 17W**
 input: **220/240V**
 Lumen: **680Lm**
 CRI: **>80**
 Light temp.: **3000°K**
 Pack: **0,038 m³**



FINISHING

-  Bianco Satinato / Satin White
-  Oro Spazzolato / Brushed Gold
-  Titanio / Titanium

IOLE

La collezione IOLE è un'impronta, un gesto, un segno grafico, che lascia una sua firma distintiva nello scenario dell'illuminazione d'interni con lampade da terra, da appoggio e a sospensione. Soprattutto con le sospensioni si possono realizzare delle composizioni dalle linee fluide, con delle silhouette decise che sapranno catturare l'attenzione, anche grazie alla possibilità di personalizzare il vostro ambiente con elementi concentrici a più livelli, un invito per la vostra estrosa creatività. IOLE oggi disponibile anche nella nuova finitura color Titanio.

The IOLE collection is an imprint, a gesture, a graphic sign, which leaves its own distinctive mark in interior lighting with floor, countertop and pendant lamps. Pendant lamps in particular offer a plethora of fluid compositions, with decisive, eye-catching silhouettes, also thanks to the spatial personalisation options with concentric elements on several levels - an invitation for your whimsical creativity. IOLE is now also available in the new titanium finish





Un segno grafico, che lascia
una sua firma distintiva
nello scenario dell'illuminazione
d'interni...

A graphic sign, which leaves
its own distinctive mark in
the interior lighting scenario...























TECHNICAL INFORMATION

Montatura in alluminio satinato bianco, oro spazzolato o titanio.
 Diffusore in silicone bianco opale.
 Sorgente luminosa led dimmerabile tramite dimmer esterno+push (non inclusi) /
 Frame in satin white, brushed gold or titanium aluminum.
 Opal white silicone diffuser.
 LED light source dimmable via external dimmer + push (not included).

**IOLE S/1**

Socket: **1 modulo LED**
 Power: **max 28W**
 input: **220/240V**
 Lumen: **1400Lm**
 CRI: **>80**
 Light temp.: **3000°K**
 Pack: **0,058 m³**

IOLE S/1 T

1 modulo LED
max 25W
220/240V
1200Lm
>80
4000°K
0,073 m³

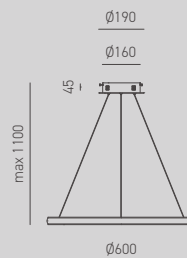
**IOLE S/2**

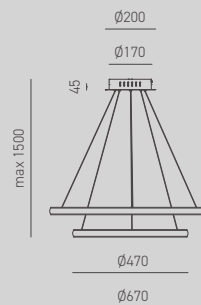

Socket: **2 moduli LED**
 Power: **max 40W**
 input: **220/240V**
 Lumen: **2000Lm**
 CRI: **>80**
 Light temp.: **3000°K**
 Pack: **0,075 m³**

**IOLE S/3**

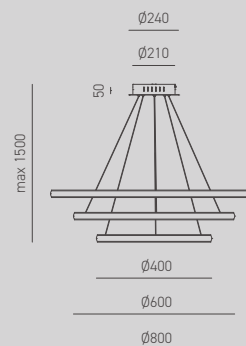
Socket: **3 moduli LED**
 Power: **max 60W**
 input: **220/240V**
 Lumen: **3000Lm**
 CRI: **>80**
 Light temp.: **3000°K**
 Pack: **0,103 m³**



FINISHING

-  Bianco / White
-  Oro Spazzolato / Brushed Gold
-  Titanio / Titanium

TECHNICAL INFORMATION

Struttura in alluminio satinato bianco, oro spazzolato o titanio.

Diffusore in silicone bianco opale.

Sorgente luminosa LED dimmerabile tramite dimmer integrato nel cablaggio /

Structure in white satin, brushed gold or titanium aluminum.

Opal white silicone diffuser.

LED light source dimmable by means of a dimmer integrated in the wiring.

**IOLE L**

Socket: **1 modulo LED**

Power: **max 12W**

input: **220/240V**

Lumen: **600Lm**

CRI: **>80**

Light temp.: **3000°K**

Pack: **0,054 m³**

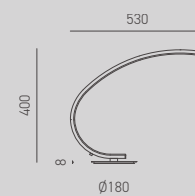
**IOLE PT**

Socket: **1 modulo LED**

Power: **max 30W**

input: **220/240V**

Lumen: **1500Lm**

CRI: **>80**

Light temp.: **3000°K**

Pack: **0,142 m³**

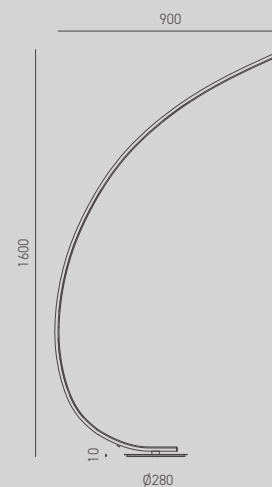



NICOLE

Profilo contemporaneo, elegante e sorprendente nel contempo, le sue curve delicate esprimono una forma versatile capace di integrarsi e dialogare con qualsiasi ambiente. Diverse sono le finiture disponibili, un'elegante palette cromatica per una lampada dalla personalità fluida e discreta.

Contemporary, elegant yet surprising profile: its delicate curves express a versatile shape designed to seamlessly blend and connect with any environment. Several finishes available, an elegant colour palette for a lamp with a fluid and discreet personality





TECHNICAL INFORMATION

Montatura in alluminio bianco satinato, nero satinato, oro spazzolato o titanio.
 Diffusore in silicone bianco opale.
 Sorgente luminosa led; dimmerabile tramite dimmer integrato nel cablaggio /
 Frame in satin white or satin black aluminium, brushed gold or titanium.
 Opal white silicone diffuser.
 LED light source with inline cord dimmer.





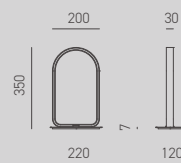

NICOLE L

Power: **max 12W**
 input: **220/240V**
 Lumen: **600Lm**
 CRI: **>80**
 Light temp.: **3000°K**
 Pack: **0,023 m³**



FINISHING

-  Bianco Satinato / Satin White
-  Oro Spazzolato / Brushed Gold
-  Nero Satinato / Satin Black
-  Titanio / Titanium

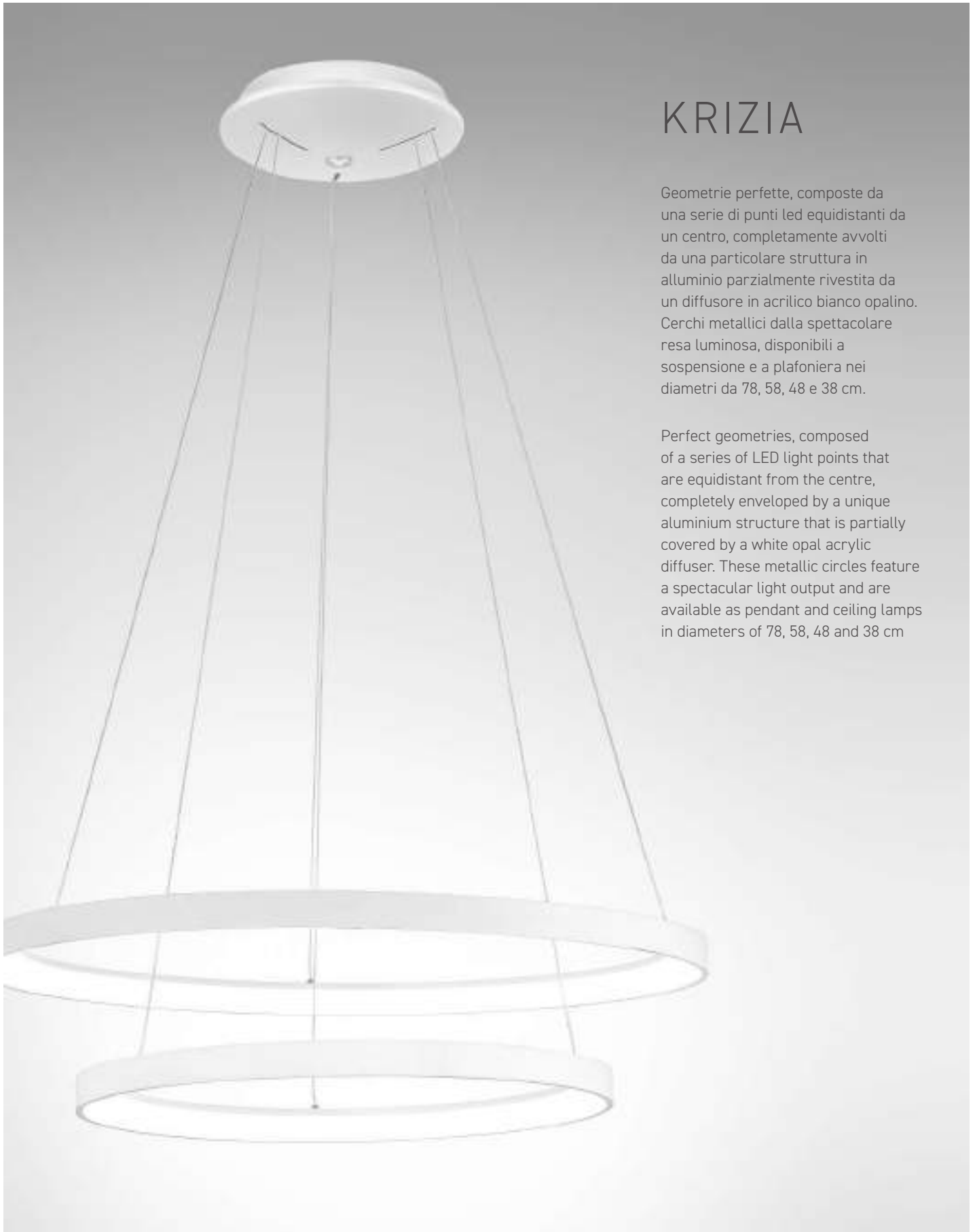

KRIZIA

Geometrie perfette, composte da una serie di punti led equidistanti da un centro, completamente avvolti da una particolare struttura in alluminio parzialmente rivestita da un diffusore in acrilico bianco opalino. Cerchi metallici dalla spettacolare resa luminosa, disponibili a sospensione e a plafoniera nei diametri da 78, 58, 48 e 38 cm.

Perfect geometries, composed of a series of LED light points that are equidistant from the centre, completely enveloped by a unique aluminium structure that is partially covered by a white opal acrylic diffuser. These metallic circles feature a spectacular light output and are available as pendant and ceiling lamps in diameters of 78, 58, 48 and 38 cm











TECHNICAL INFORMATION

Montatura in alluminio satinato bianco o oro spazzolato.
 Diffusore in acrilico bianco opale.
 Sorgente luminosa led, dimmerabile tramite dimmer esterno+push (non incluso) /
 Frame in satin white or brushed gold aluminium. Opal white acrylic diffuser.
 Led light source.
 Dimmable via external dimmer +push (not included)

**KRIZIA S/P Bianco**

Socket: **1 modulo LED**
 Power: **max 38W**
 Input: **220/240V**
 Lumen: **2300Lm**
 CRI: **>80**
 Light temp.: **3000°K**
 Pack: **0,026 m³**

KRIZIA S/P Oro

Socket: **1 modulo LED**
 Power: **max 38W**
 Input: **220/240V**
 Lumen: **2200Lm**
 CRI: **>80**
 Light temp.: **3000°K**
 Pack: **0,026 m³**

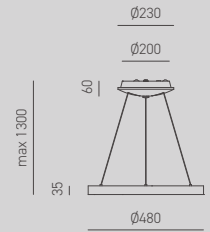
**KRIZIA S/M Bianco**

Socket: **1 modulo LED**
 Power: **max 50W**
 Input: **220/240V**
 Lumen: **2900Lm**
 CRI: **>80**
 Light temp.: **3000°K**
 Pack: **0,038 m³**

KRIZIA S/M Oro

Socket: **1 modulo LED**
 Power: **max 50W**
 Input: **220/240V**
 Lumen: **2800Lm**
 CRI: **>80**
 Light temp.: **3000°K**
 Pack: **0,038 m³**

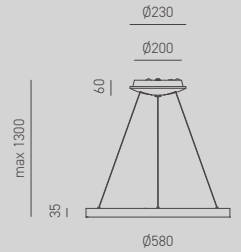
**KRIZIA S/G Bianco**

Socket: **1 modulo LED**
 Power: **max 60W**
 Input: **220/240V**
 Lumen: **4800Lm**
 CRI: **>80**
 Light temp.: **3000°K**
 Pack: **0,064 m³**

KRIZIA S/G Oro

Socket: **1 modulo LED**
 Power: **max 60W**
 Input: **220/240V**
 Lumen: **4600Lm**
 CRI: **>80**
 Light temp.: **3000°K**
 Pack: **0,064 m³**

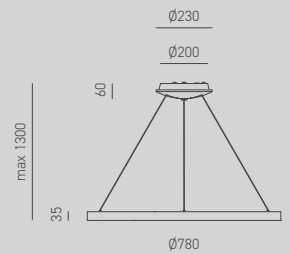
**KRIZIA S/2 Bianco**

Socket: **2 moduli LED**
 Power: **max 38W+
50W=88W**
 Input: **220/240V**
 Lumen: **6300Lm**
 CRI: **>80**
 Light temp.: **3000°K**
 Pack: **0,038 m³**

KRIZIA S/2 Oro

Socket: **2 moduli LED**
 Power: **max 38W+
50W=88W**
 Input: **220/240V**
 Lumen: **6000Lm**
 CRI: **>80**
 Light temp.: **3000°K**
 Pack: **0,038 m³**

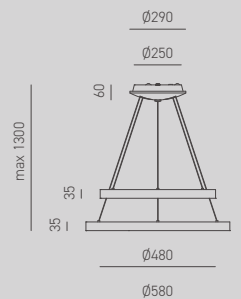

FINISHING

 Bianco / White

 Oro Spazzolato / Brushed Gold

**KRIZIA P/P Bianco**

Socket: **1 modulo LED**
 Power: **max 30W**
 Input: **220/240V**
 Lumen: **2600Lm**
 CRI: **>80**
 Light temp.: **3000°K**
 Pack: **0,015 m³**

KRIZIA P/P Oro

Socket: **1 modulo LED**
 Power: **max 30W**
 Input: **220/240V**
 Lumen: **2500Lm**
 CRI: **>80**
 Light temp.: **3000°K**
 Pack: **0,015 m³**

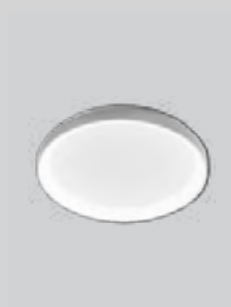
**KRIZIA P/M Bianco**

Socket: **1 modulo LED**
 Power: **max 38W**
 Input: **220/240V**
 Lumen: **3300Lm**
 CRI: **>80**
 Light temp.: **3000°K**
 Pack: **0,023 m³**

KRIZIA P/M Oro

Socket: **1 modulo LED**
 Power: **max 38W**
 Input: **220/240V**
 Lumen: **3200Lm**
 CRI: **>80**
 Light temp.: **3000°K**
 Pack: **0,023 m³**

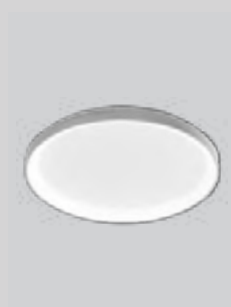
**KRIZIA P/G Bianco**

Socket: **1 modulo LED**
 Power: **max 50W**
 Input: **220/240V**
 Lumen: **4100Lm**
 CRI: **>80**
 Light temp.: **3000°K**
 Pack: **0,033 m³**

KRIZIA P/G Oro

Socket: **1 modulo LED**
 Power: **max 50W**
 Input: **220/240V**
 Lumen: **4000Lm**
 CRI: **>80**
 Light temp.: **3000°K**
 Pack: **0,033 m³**

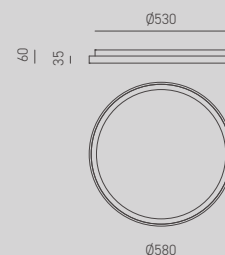
**KRIZIA P/S Bianco**

Socket: **1 modulo LED**
 Power: **max 60W**
 Input: **220/240V**
 Lumen: **5300Lm**
 CRI: **>80**
 Light temp.: **3000°K**
 Pack: **0,057 m³**

KRIZIA P/S Oro

Socket: **1 modulo LED**
 Power: **max 60W**
 Input: **220/240V**
 Lumen: **5100Lm**
 CRI: **>80**
 Light temp.: **3000°K**
 Pack: **0,057 m³**

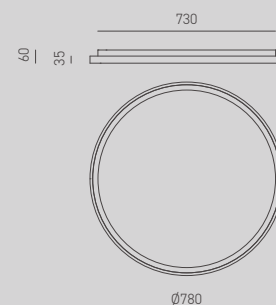



YARA

Ispirata agli anelli planetari che ruotano attorno a Saturno, Yara è un costante rincorrersi di linee sinuose, curve precise e regolari che creano forme perfette.

La particolare luce led continua, interna ed esterna al profilo della struttura, amplifica la resa luminosa evidenziando il design avveniristico di questo intrigante prodotto. Futurismo e funzionalità.

Inspired by the planetary rings that rotate around Saturn, Yara is a constant succession of sinuous lines and precise, regular curves that create perfect shapes. The special constant LED light, inside and outside the profile of the structure, amplifies the light output, highlighting the futuristic design of this intriguing product. Functional futurism.









TECHNICAL INFORMATION

Montatura in alluminio satinato bianco.
 Diffusore in silicone bianco opale.
 Sorgente luminosa led dimmerabile
 tramite dimmer esterno
 + push (non inclusi) /
 Frame in satin white, opal white
 silicone diffuser.
 Led light source.
 Dimmable via external dimmer
 + push (not included)

**YARA P/P C**

Socket: **1 modulo LED**
 Power: **max 30W**
 Input: **220/240V**
 Lumen: **1300Lm**
 CRI: **>80**
 Light temp.: **3000°K**
 Pack: **0,073 m³**

YARA P/P N

Socket: **1 modulo LED**
 Power: **max 30W**
 Input: **220/240V**
 Lumen: **1400Lm**
 CRI: **>80**
 Light temp.: **4000°K**
 Pack: **0,073 m³**

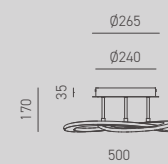
**YARA P/M C**

Socket: **1 modulo LED**
 Power: **max 40W**
 Input: **220/240V**
 Lumen: **1900Lm**
 CRI: **>80**
 Light temp.: **3000°K**
 Pack: **0,101 m³**

YARA P/M N

Socket: **1 modulo LED**
 Power: **max 40W**
 Input: **220/240V**
 Lumen: **2000Lm**
 CRI: **>80**
 Light temp.: **4000°K**
 Pack: **0,101 m³**

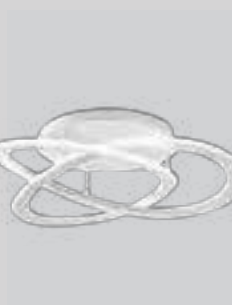
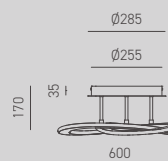
**YARA P/G C**

Socket: **1 modulo LED**
 Power: **max 50W**
 Input: **220/240V**
 Lumen: **2400Lm**
 CRI: **>80**
 Light temp.: **3000°K**
 Pack: **0,133 m³**

YARA P/G N

Socket: **1 modulo LED**
 Power: **max 50W**
 Input: **220/240V**
 Lumen: **2500Lm**
 CRI: **>80**
 Light temp.: **4000°K**
 Pack: **0,133 m³**

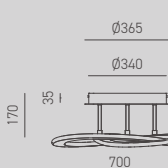
**YARA S/P C**

Socket: **1 modulo LED**
 Power: **max 40W**
 Input: **220/240V**
 Lumen: **1900Lm**
 CRI: **>80**
 Light temp.: **3000°K**
 Pack: **0,070 m³**

YARA S/P N

Socket: **1 modulo LED**
 Power: **max 40W**
 Input: **220/240V**
 Lumen: **2000Lm**
 CRI: **>80**
 Light temp.: **4000°K**
 Pack: **0,070 m³**

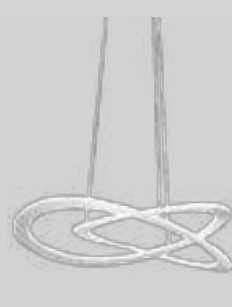
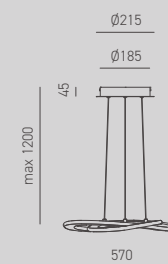
**YARA S/G C**

Socket: **1 modulo LED**
 Power: **max 50W**
 Input: **220/240V**
 Lumen: **2400Lm**
 CRI: **>80**
 Light temp.: **3000°K**
 Pack: **0,092 m³**

YARA S/G N

Socket: **1 modulo LED**
 Power: **max 50W**
 Input: **220/240V**
 Lumen: **2500Lm**
 CRI: **>80**
 Light temp.: **4000°K**
 Pack: **0,092 m³**

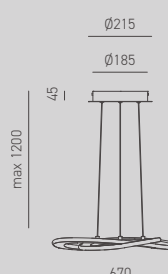

FINISHING

 Bianco Satinato / Satin White



BERTA

La linea armoniosa e sinuosa del profilo luminoso e la semplicità della struttura si coniugano in una sintesi perfetta. La purezza concettuale si ottiene riducendo il superfluo senza tuttavia perdere in praticità. Le finiture disponibili sono il compendio per un gusto informale e contemporaneo.

The harmonious and sinuous line of the luminous profile and the structure simplicity combine into a perfect whole. Design purity is attained by reducing any superfluous elements while retaining its practicality. Available finishes range from the informal to the most contemporary taste





TECHNICAL INFORMATION

Montatura orientabile in alluminio
bianco satinato o oro spazzolato.
Diffusore in silicone bianco opale.
Sorgente luminosa led; dimmerabile
tramite dimmer esterno + push
(non inclusi).
Piantana dimmerabile tramite dimmer
integrato nel cablaggio /
Adjustable frame in satin white
or brushed gold aluminum.
Opal white silicone diffuser.
LED light source; dimmable via
external dimmer + push-button
dimmer (not included).
Floor lamp with inline cord dimmer.

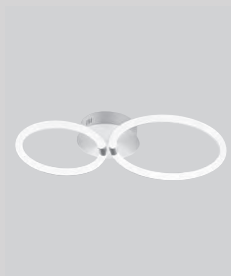
**BERTA P/P**

Power: **max 30W**
input: **220/240V**
Lumen: **2000Lm**
CRI: **>80**
Light temp.: **3000°K**
Pack: **0,026 m³**

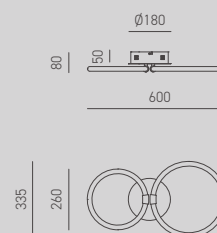
**BERTA P/G**

Power: **max 50W**
input: **220/240V**
Lumen: **3000Lm**
CRI: **>80**
Light temp.: **3000°K**
Pack: **0,046 m³**

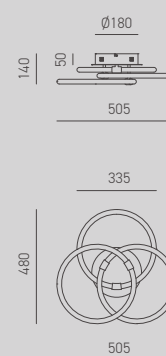
**BERTA PT**

Power: **max 30W**
input: **220/240V**
Lumen: **1900Lm**
CRI: **>80**
Light temp.: **3000°K**
Pack: **0,251 m³**



FINISHING

-  Bianco Satinato / Satin White
-  Oro Spazzolato / Brushed Gold





KATRINE

Stesso raffinato concetto della serie BERTA. Caratterizzata da una silhouette all'apparenza semplice, ma espressiva che ben si adatta ai più diversi contesti, dagli ambienti domestici a quelli di ambito commerciale. Un utilizzo dinamico e vivace.

Same refined concept as the BERTA series. Features an apparently simple yet expressive silhouette befitting most contexts, from domestic to commercial environments; for a dynamic and lively use.



TECHNICAL INFORMATION

Montatura in alluminio bianco satinato, nero satinato o oro spazzolato.
 Diffusore in silicone bianco opale.
 Sorgente luminosa led; dimmerabile tramite dimmer esterno + pus (non inclusi) /
 Frame in satin white or satin black aluminium, or brushed gold. Opal white silicone diffuser
 LED light source; dimmable via external dimmer + push-button dimmer (not included)

**KATRINE P/P**

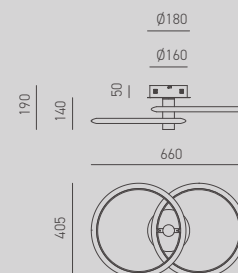

Power: **max 40W**
 input: **220/240V**
 Lumen: **2000Lm**
 CRI: **>80**
 Light temp.: **3000°K**
 Pack: **0,051 m³**

**KATRINE P/M**

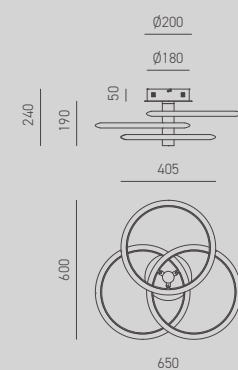
Power: **max 60W**
 input: **220/240V**
 Lumen: **3000Lm**
 CRI: **>80**
 Light temp.: **3000°K**
 Pack: **0,062 m³**



FINISHING

-  Bianco Satinato / Satin White
-  Nero Satinato / Satin Black
-  Oro Spazzolato / Brushed Gold

EVELINE

Caratterizzata da un design curvo ed elegantemente semplice. Rivela uno spirito giocoso ma sofisticato perché cela una straordinaria complessità tecnica e funzionale. Sono possibili infatti 3 tipi di accensione: solo faretto/spot, solo strip led o in combinata faretto/spot + strip led.

Featuring a curved and elegantly simple design. Reveals a playful yet sophisticated spirit that hides an extraordinary technical and functional complexity. Offers three lighting configurations: spotlight only, LED strip only, or spotlight + LED strip combination



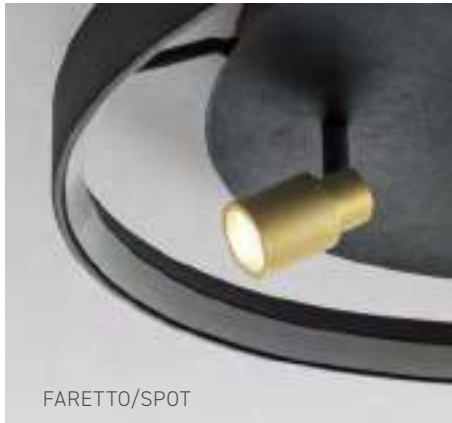

TECHNICAL INFORMATION



Montatura in alluminio bianco satinato o nero satinato con particolari oro spazzolato.
 Diffusore in silicone bianco opale.
 Sorgente luminosa led.
 Accensione separata delle 2 fonti luminose (anello esterno, spot centrali) tramite interruttore /
 Frame in satin white or satin black aluminum with brushed gold details. Opal white silicone diffuser.
 LED light source. Each light source can be independently operated (outer ring, central spot) by means of a switch.

**EVELINE P/G**

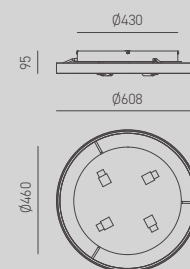
Power: **max 40W**
 input: **220/240V**
 Lumen: **2000Lm**
 CRI: **>80**
 Light temp.: **3000°K**
 Pack: **0,057 m³**



FINISHING

-  Bianco Satinato / Satin White
-  Nero Satinato-Oro
Satin Black-Gold

MELANIA

Dare forma alla forma. Un gioco di parole o una semplice sottolineatura? Due semplici circonferenze inscritte l'una nell'altra: Melania rappresenta un'intuizione stilistica in grado di arricchire di significato e stile l'ambiente che la accoglie.

Giving shape to shape. A play on words or merely emphasising its meaning? Melania features two simple circumferences inscribed one inside the other, representing a stylistic intuition capable of enhancing any space with meaning and style.







TECHNICAL INFORMATION

Montatura in alluminio verniciato bianco.
 Diffusore in metacrilato satinato bianco.
 Sorgente luminosa led /
 White painted aluminium frame.
 Satin white methacrylate diffuser.
 LED light source.

**MELANIA P/P 3000°K**

Socket: **2 moduli LED**
 Power: **max 30W**
 Input: **220/240V**
 Lumen: **1300Lm**
 CRI: **>80**
 Light temp.: **3000°K**
 Pack: **0,012 m³**

MELANIA P/P 4000°K

Socket: **2 moduli LED**
 Power: **max 30W**
 Input: **220/240V**
 Lumen: **1600Lm**
 CRI: **>80**
 Light temp.: **4000°K**
 Pack: **0,012 m³**

**MELANIA P/M 3000°K**

Socket: **2 moduli LED**
 Power: **max 40W**
 Input: **220/240V**
 Lumen: **1700Lm**
 CRI: **>80**
 Light temp.: **3000°K**
 Pack: **0,020 m³**

MELANIA P/M 4000°K

Socket: **2 moduli LED**
 Power: **max 40W**
 Input: **220/240V**
 Lumen: **1820Lm**
 CRI: **>80**
 Light temp.: **4000°K**
 Pack: **0,020 m³**

**MELANIA P/G 3000°K**

Socket: **2 moduli LED**
 Power: **max 50W**
 Input: **220/240V**
 Lumen: **2100Lm**
 CRI: **>80**
 Light temp.: **3000°K**
 Pack: **0,029 m³**

MELANIA P/G 4000°K

Socket: **2 moduli LED**
 Power: **max 50W**
 Input: **220/240V**
 Lumen: **2260Lm**
 CRI: **>80**
 Light temp.: **4000°K**
 Pack: **0,029 m³**



FINISHING

 Bianco / White





CINZIA

Ilumina con l'eleganza dei suoi bracci, che si rincorrono in un intrecciarsi di curve, con una linea semplice, essenziale, fluida. Un raffinato stile classico rivisto e reinterpretato in ambito contemporaneo che decora ed arreda ogni ambiente.

Illuminates with the elegance of its arms, which chase each other in an intertwining of curves, with a simple, essential, fluid line. A refined classic style, revised and reinterpreted in a contemporary context, to decorate and furnish any environment



TECHNICAL INFORMATION

Montatura in alluminio bianco satinato o oro spazzolato.

Diffusore in silicone bianco opale.

Sorgente luminosa led; dimmerabile tramite dimmer esterno + push (non inclusi) /

Frame in satin white aluminium or brushed gold.

Opal white silicone diffuser.

LED light source; dimmable via external dimmer + push-button dimmer (not included).

**CINZIA S**

Socket: **4 moduli LED**
 Power: **max 46W**
 input: **220/240V**
 Lumen: **2300Lm**
 CRI: **>80**
 Light temp.: **3000°K**
 Pack: **0,148 m³**

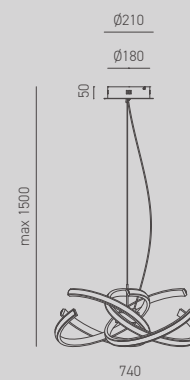

FINISHING



Bianco Satinato / Satin White



Oro Spazzolato / Brushed Gold



TOSCA

Proposta nelle versioni a uno, tre e quattro steli ricurvi, led in linea continua, uno schermo protettivo che garantisce comfort visivo senza precludere la luminosità dell'apparecchio. Design singolare e fresco che ben si adatta a qualunque stile di arredo.

Tosca is available in versions with one, three and four curved stems, LEDs in a continuous line and a protective screen that guarantees visual comfort without hindering the brightness of the lighting fixture. Its unique and fresh design is well suited to any furnishing style.





TECHNICAL INFORMATION

Plafoniere con montatura in alluminio satinato bianco. Diffusore in silicone bianco opale.
Sorgente luminosa led./
Ceiling lighting with satin white aluminium frame.
Opal white silicone diffuser.
LED light source.

**TOSCA P/1 3000°K**

Socket: **1 modulo LED**
Power: **max 15W**
Input: **220/240V**
Lumen: **840Lm**
CRI: **>80**
Light temp.: **3000°K**
Pack: **0,024 m³**

TOSCA P/1 4000°K

Socket: **1 modulo LED**
Power: **max 15W**
Input: **220/240V**
Lumen: **840Lm**
CRI: **>80**
Light temp.: **4000°K**
Pack: **0,024 m³**

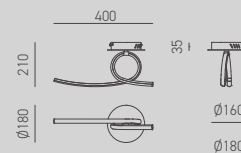
**TOSCA P/3 3000°K**

Socket: **3 moduli LED**
Power: **max 45W**
Input: **220/240V**
Lumen: **2500Lm**
CRI: **>80**
Light temp.: **3000°K**
Pack: **0,059 m³**

TOSCA P/3 4000°K

Socket: **3 moduli LED**
Power: **max 45W**
Input: **220/240V**
Lumen: **2500Lm**
CRI: **>80**
Light temp.: **4000°K**
Pack: **0,059 m³**

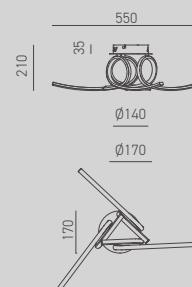
**TOSCA P/4 3000°K**

Socket: **4 moduli LED**
Power: **max 60W**
Input: **220/240V**
Lumen: **3200Lm**
CRI: **>80**
Light temp.: **3000°K**
Pack: **0,049 m³**

TOSCA P/4 4000°K

Socket: **4 moduli LED**
Power: **max 60W**
Input: **220/240V**
Lumen: **3200Lm**
CRI: **>80**
Light temp.: **4000°K**
Pack: **0,049 m³**

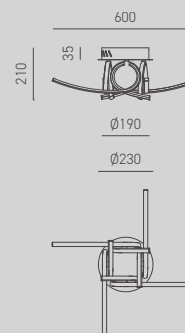

FINISHING



Bianco Satinato / Satin White

TESSA



Perfetta sintesi di semplicità e funzionalità, con le sue fattezze sinuose e minimali Tessa genera un'armonia unica, piacevole e rilassante. Progettata nelle due varianti a 3 e 5 steli, viene proposta esclusivamente nella finitura verniciata bianca che ne esalta esplicitamente il candore /

With its sinuous and minimalist features, Tessa generates a unique, pleasant and relaxing harmony through the perfect synthesis of simplicity and functionality. The series is designed in two variants with 3 and 5 stems and is offered exclusively in a white painted finish which expressly enhances its brilliant pale quality.



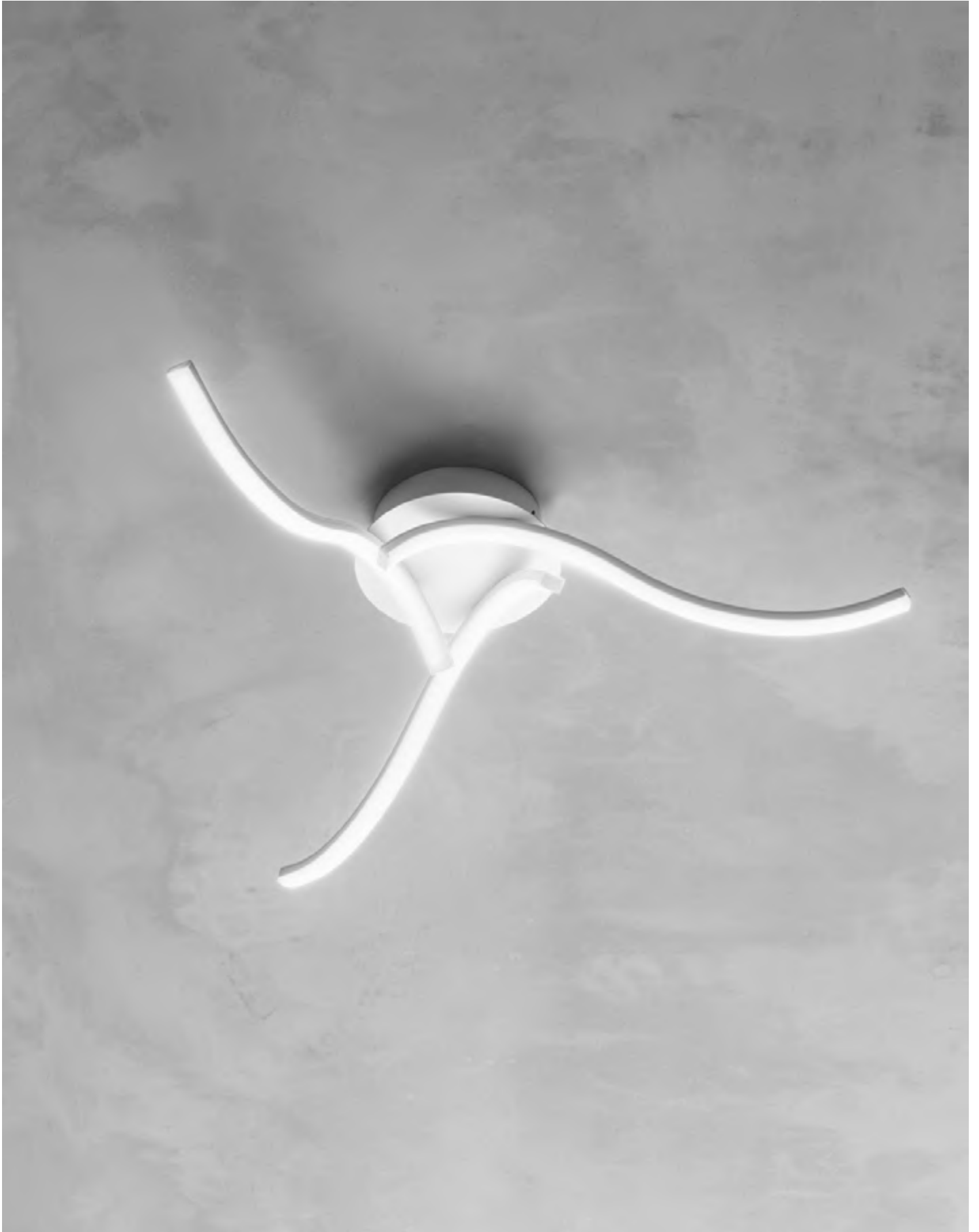

TECHNICAL INFORMATION

Plafoniere con montatura in alluminio satinato bianco. Diffusore in silicone bianco opale.

Sorgente luminosa led./

Ceiling lighting with satin white aluminium frame.

Opal white silicone diffuser.

LED light source.

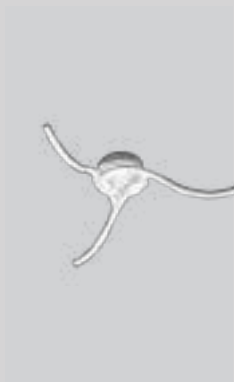
**TESSA P/3 3000°K**

Socket: **3 moduli LED**
 Power: **max 23W**
 Input: **220/240V**
 Lumen: **1300Lm**
 CRI: **>80**
 Light temp.: **3000°K**
 Pack: **0,053 m³**

TESSA P/3 4000°K

Socket: **3 moduli LED**
 Power: **max 23W**
 Input: **220/240V**
 Lumen: **1300Lm**
 CRI: **>80**
 Light temp.: **4000°K**
 Pack: **0,053 m³**

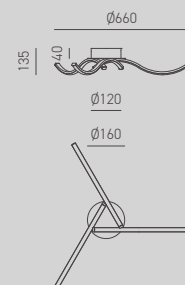
**TESSA P/5 3000°K**

Socket: **5 moduli LED**
 Power: **max 38W**
 Input: **220/240V**
 Lumen: **2300Lm**
 CRI: **>80**
 Light temp.: **3000°K**
 Pack: **0,074 m³**

TESSA P/5 4000°K

Socket: **5 moduli LED**
 Power: **max 38W**
 Input: **220/240V**
 Lumen: **2300Lm**
 CRI: **>80**
 Light temp.: **4000°K**
 Pack: **0,074 m³**

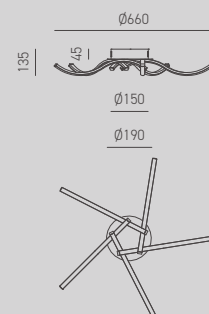

FINISHING



Bianco Satinato / Satin White



AFRODITE

Esprime con la sua essenza, una grande semplicità e leggerezza. Un design che varia in base al punto di vista. Con un effetto a zig-zag fluido e lineare oppure, ruotando di 45° la sua installazione, si ottiene una configurazione più intima e compatta. Disponibile in due modelli e in tre differenti finiture.

Its essence conveys a striking simplicity and lightness. A design that varies according to the installation approach.

Create a fluid and linear zig-zag effect or - by rotating its installation by 45° - a more intimate and compact configuration. Available in two models and in three different finishes





TECHNICAL INFORMATION

Montatura in alluminio bianco satinato, oro spazzolato o titanio.

Diffusore in silicone bianco opale.

Sorgente luminosa led; dimmerabile tramite dimmer esterno + push (non inclusi) /

Frame in satin white aluminum, brushed gold or titanium.

Opal white silicone diffuser.

LED light source; dimmable via external dimmer + push-button dimmer (not included).

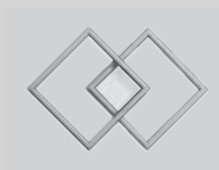

AFRODITE P/P

Socket: **2 moduli LED**

Power: **max 28W**

input: **220/240V**

Lumen: **1400Lm**

CRI: **>80**

Light temp.: **3000°K**

Pack: **0,021 m³**

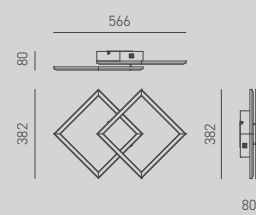

AFRODITE P/M

Socket: **3 moduli LED**

Power: **max 40W**

input: **220/240V**

Lumen: **2000Lm**



CRI: **>80**

Light temp.: **3000°K**

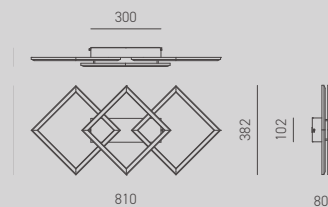
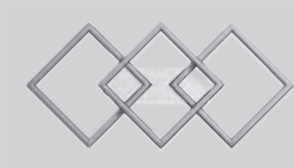
Pack: **0,04 m³**



FINISHING

-  Bianco Satinato / Satin White
-  Oro Spazzolato / Brushed Gold
-  Titanio / Titanium



TULLIA

Tullia è la lampada da soffitto e da parete ispirata al minimalismo dell'arte moderna, proposta nelle varianti a 3 o 4 steli. La sua peculiarità consiste nel poter orientare gli steli che la compongono, permettendovi di creare molteplici configurazioni in grado di arredare il vostro living in modo sempre differente.

Tullia is the ceiling and wall lamp inspired by the minimalism of modern art, offered in 3 or 4 stem variants. What makes the Tullia series special is that you are able to direct its stems, allowing you to create multiple configurations and illuminate your living room in an ever-changing way.





TECHNICAL INFORMATION

Plafoniere con montatura in alluminio satinato bianco. Diffusore in silicone bianco opale.

Sorgente luminosa led./

Ceiling lighting with satin white aluminium frame. Opal white silicone diffuser.

LED light source.

**TULLIA P/3 3000°K**

Socket: **3 moduli LED**
 Power: **max 30W**
 Input: **220/240V**
 Lumen: **1700Lm**
 CRI: **>80**
 Light temp.: **3000°K**
 Pack: **0,019 m³**

TULLIA P/3 4000°K

Socket: **3 moduli LED**
 Power: **max 30W**
 Input: **220/240V**
 Lumen: **1700Lm**
 CRI: **>80**
 Light temp.: **4000°K**
 Pack: **0,019 m³**

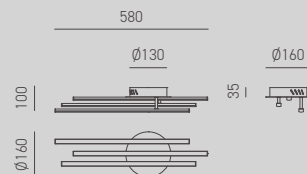
**TULLIA P/4 3000°K**

Socket: **4 moduli LED**
 Power: **max 40W**
 Input: **220/240V**
 Lumen: **2200Lm**
 CRI: **>80**
 Light temp.: **3000°K**
 Pack: **0,027 m³**

TULLIA P/4 4000°K

Socket: **4 moduli LED**
 Power: **max 40W**
 Input: **220/240V**
 Lumen: **2200Lm**
 CRI: **>80**
 Light temp.: **4000°K**
 Pack: **0,027 m³**

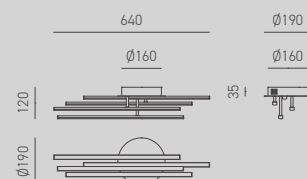

FINISHING



Bianco Satinato / Satin White

FILLY

Una linea essenziale dalla forma scolpita, eliminando il superfluo perché le cose più semplici sono le migliori.

Una gamma di versioni che abbraccia un vasto assortimento di possibili composizioni singole o multiple a 3, 5, 12 luci.

Assortimento cromatico con una palette colori che saprà soddisfare ogni vostra esigenza.

Essential lines with a sculpted shape, devoid of any superfluous elements be the simplest things are the best.

A range that encompasses a vast assortment of possible single or multiple compositions with 3, 5, 12 lights.

Colour range with a palette that will meet your every need.









TECHNICAL INFORMATION

Sospensioni senza rosoni dotati di cavo elettrico rivestito in tessuto 3m, sezione 2x0,75mm. Portalampade E27. Lampadina non inclusa.

Finiture: Bianco satinato con cavo in tessuto bianco; Nero satinato con cavo in tessuto nero; Ottone con cavo in tessuto oro; Rame con cavo in tessuto marrone; Nickel satinato con cavo in tessuto grigio; Grigio cemento con cavo in tessuto grigio /
Pendant lights without canopy equipped with a fabric sheathed, 3m electric cable, 2x0.75mm section. Lampholder E27. Bulb not included.
Available finishes: satin white with white fabric cable; satin black with black fabric cable; brass with gold fabric cable; copper with brown fabric cable; satin nickel with grey fabric cable; concrete grey with grey fabric cable.



GSOS01 Bianco Satinato/Sand White

GSOS02 Nero Satinato/Sand Black

GSOS03 Ottone/Brass

GSOS04 Rame/Copper

GSOS05 Nickel Satinato/Satin Nickel

GSOS06 Grigio Cemento/Concrete Grey



Socket: **1xE27**

Power: **max 40W**

input: **220/240V**

IP: **20**

Pack: **0,0086 m³**

GSOB40

Rosone rettangolare a tre fori in metallo con staffa ed accessori per il fissaggio inclusi. Inclusi tre pressacavi e morsettiera elettrica. Finiture: Bianco satinato; Nero satinato; Ottone; Rame; Nickel satinato; Grigio cemento /

Three-hole, rectangular metal ceiling rose with bracket and fixing accessories included. Includes three cable glands and electrical terminal block.

Finishes: Matt white; Matt black; Brass; Copper; Matt nickel; Slate grey.

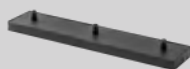

GSOB40 Bianco Satinato/Sand White

GSOB41 Nero Satinato/Sand Black

GSOB42 Ottone/Brass

GSOB43 Rame/Copper

GSOB44 Nickel Satinato/Satin Nickel

GSOB45 Grigio Cemento/Concrete Grey

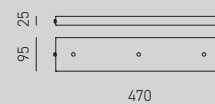
**GSOB20**

Rosone rettangolare a cinque fori in metallo con staffa ed accessori per il fissaggio inclusi. Inclusi cinque pressacavi e morsettiera elettrica. Finiture: Bianco satinato; Nero satinato; Ottone; Rame; Nickel satinato; Grigio cemento /

Five-hole, rectangular metal ceiling rose with bracket and fixing accessories included. Includes five cable glands and electrical terminal block. Finishes: Matt white; Matt black; Brass; Copper; Matt nickel; Slate grey.

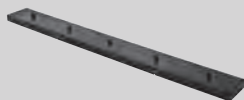

GSOB20 Bianco Satinato/Sand White

GSOB21 Nero Satinato/Sand Black

GSOB22 Ottone/Brass





GSOB23 Rame/Copper

GSOB24 Nickel Satinato/Satin Nickel

GSOB25 Grigio Cemento/Concrete Grey



FINISHING

-  Bianco Satinato / Satin White
-  Nero Satinato / Satin Black
-  Ottone / Brass
-  Rame / Copper
-  Nickel Satinato / Satin Nickel
-  Grigio Cemento / Concrete Grey

TECHNICAL INFORMA

Rosone ad un foro in metallo con staffa ed accessori per il fissaggio inclusi. Incluso un pressacavo e morsettiera elettrica. Finiture: Bianco satinato; Nero satinato; Ottone; Rame; Nickel satinato; Grigio cemento / One-hole metal ceiling rose with bracket and fixing accessories included. Includes a cable gland and electrical terminal block. Finishes: Matt white; Matt black; Brass; Copper; Matt nickel; Slate grey.



GSOB10 Bianco Satinato/Sand White
GSOB11 Nero Satinato/Sand Black
GSOB12 Ottone/Brass
GSOB13 Rame/Copper
GSOB14 Nickel Satinato/Satin Nickel
GSOB15 Grigio Cemento/Concrete Grey



Rosone a tre fori in metallo con staffa ed accessori per il fissaggio inclusi. Inclusi tre pressacavi e morsettiera elettrica. Finiture: Bianco satinato; Nero satinato; Ottone; Rame; Nickel satinato; Grigio cemento / Three-hole metal ceiling rose with bracket and fixing accessories included. Includes three cable glands and electrical terminal block. Finishes: Matt white; Matt black; Brass; Copper; Matt nickel; Slate grey./



GSOB30 Bianco Satinato/Sand White
GSOB31 Nero Satinato/Sand Black
GSOB32 Ottone/Brass
GSOB33 Rame/Copper
GSOB34 Nickel Satinato/Satin Nickel
GSOB35 Grigio Cemento/Concrete Grey

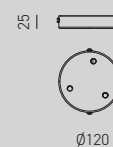

Rosone a cinque fori in metallo con staffa ed accessori per il fissaggio inclusi. Inclusi cinque pressacavi e morsettiera elettrica. Finiture: Bianco satinato; Nero satinato; Ottone; Rame; Nickel satinato; Grigio cemento / Five-hole metal ceiling rose with bracket and fixing accessories included. Includes five cable glands and electrical terminal block. Finishes: Matt white; Matt black; Brass; Copper; Matt nickel; Slate grey./



GSOB50 Bianco Satinato/Sand White
GSOB51 Nero Satinato/Sand Black
GSOB52 Ottone/Brass
GSOB53 Rame/Copper
GSOB54 Nickel Satinato/Satin Nickel
GSOB55 Grigio Cemento/Concrete Grey

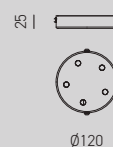

Rosone a dodici fori laterali in metallo con staffa ed accessori per il fissaggio inclusi. Inclusi dodici pressacavi e morsettiere elettriche. Finiture: Bianco satinato; Nero satinato; Ottone; Rame; Nickel satinato; Grigio cemento / Metal ceiling rose with twelve lateral holes, includes bracket and fixing accessories. Twelve cable glands and electrical terminal blocks included. Finishes: Matt white; Matt black; Brass; Copper; Matt nickel; Slate grey.



GSOB01 Bianco Satinato/Sand White
GSOB02 Nero Satinato/Sand Black
GSOB03 Ottone/Brass
GSOB04 Rame/Copper
GSOB05 Nickel Satinato/Satin Nickel
GSOB06 Grigio Cemento/Concrete Grey

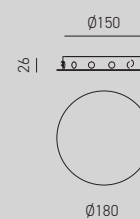

Decentratore in metallo con aggancio e fissaggio con grano per cavi in stoffa 2x0,75mm. Finiture: Bianco satinato; Nero satinato; Ottone; Rame; Nickel satinato; Grigio cemento / Metal decentralizer with hook and dowel fitting for 2x0.75mm fabric cables. Finishes: Matt white; Matt black; Brass; Copper; Matt nickel; Slate grey.



GSOBL10 Bianco Satinato/Sand White
GSOBL11 Nero Satinato/Sand Black
GSOBL12 Ottone/Brass
GSOBL13 Rame/Copper
GSOBL14 Nickel Satinato/Satin Nickel
GSOBL15 Grigio Cemento/Concrete Grey

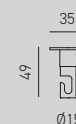

Decentratore in metallo con regolazione per cavi in stoffa 2x0,75mm. Finiture: Bianco satinato; Nero satinato; Ottone; Rame; Nickel satinato; Grigio cemento / Metal decentraliser with adjustment for 2x0.75mm fabric cables. Finishes: Matt white; Matt black; Brass; Copper; Matt nickel; Slate grey.



GSOBL01 Bianco Satinato/Sand White
GSOBL02 Nero Satinato/Sand Black
GSOBL03 Ottone/Brass
GSOBL04 Rame/Copper
GSOBL05 Nickel Satinato/Satin Nickel
GSOBL06 Grigio Cemento/Concrete Grey



EDITH

Il design è il vero protagonista che usa la geometria per uscire dagli schemi e creare una nuova combinazione stilistica con un gioco di sfaccettature importanti per caratterizzare l'estetica del prodotto. Sospensione in pressofusione d'alluminio disponibile in bianco o nero granuloso e materico.

Design, the real protagonist here, relies on geometry to break the mould and create a new stylistic combination, playing with major facets to define the product's visual appearance. Pendant light in die-cast aluminum available in grainy and textured black or white.





TECHNICAL INFORMATION



Montatura metallo satinato bianco
o satinato nero.
Lampadina non inclusa /
Satin white or satin black metal
frame. Bulb not included.

**EDITH S**

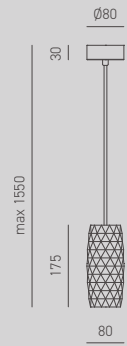
Socket: **1xGu10**
Power: **max 35W**
input: **220/240V**
Pack: **0,0025 m³**



FINISHING

-  Bianco / White
-  Nero / Black



JADE

La ricerca formale, una versatilità espressiva data dal chiaro scuro delle sue superfici che scolpisce e ne definisce il volume. Piccola, coccola con una grande anima. Una combinazione di luci ed ombre per questo corpo luce a sospensione.

Formal research, an expressive versatility arising from the superficial chiaroscuro that sculpts and defines its volume. Small, cute little thing with a great soul. A light and shadow combination for this pendant light



TECHNICAL INFORMATION



Montatura metallo satinato bianco o satinato nero.
Lampadina non inclusa /
Satin white or satin black metal frame.
Bulb not included.

**JADE S**

Socket: **1xGu10**
Power: **max 35W**
input: **220/240V**
Pack: **0,0025 m³**



FINISHING

-  Bianco / White
-  Nero / Black



EMILY

Sono l'aspetto sobrio e incisivo a rendere Emily il prodotto versatile ideale per ogni stile di interno. Caratterizzata da un design quasi elementare, ma al contempo accurato nei particolari tagli a laser, si propone come sospensione o come piccola plafoniera, nei colori nero e bianco. Il fascio di luce emesso dalla sorgente luminosa viene sapientemente filtrato dal diffusore opalino, rendendolo confortevole anche alla vista diretta.

Emily's understated and incisive look makes this versatile product ideal for any interior style. While an almost elementary design characterises Emily, it also features accurate laser-cut details at the same time. It is proposed as a pendant lamp or as a small ceiling lamp, in black and white. The beam of light emitted by the light source is expertly filtered by the opal diffuser, ensuring eye comfort even when it is in direct view.





TECHNICAL INFORMATION

Montatura in metallo satinato bianco o satinato nero.
 Diffusore in acrilico.
 Lampadina non inclusa./
 Satin white or satin black metal frame.
 Acrylic diffuser.
 Bulb not included.

**EMILY P**



Socket: **1xGU10**
 Power: **max 35W**
 input: **220/240V**
 Pack: **0,002 m³**

**EMILY S**

Socket: **1xGU10**
 Power: **max 35W**
 input: **220/240V**
 Pack: **0,003 m³**



FINISHING

-  Bianco / White
-  Nero / Black

DUNA



La forma cilindrica ammorbidita ai fianchi determina la fine estetica di questo prodotto, realizzato con un ricercato composto cementizio in colori che richiamano la terra quali il granito grigio chiaro o grigio scuro la pietra rossa, come se fosse stato disegnato dal caldo vento del deserto. Il design di Duna è puro essenzialismo ispirato dalle forme presenti in natura.

The cylindrical shape softened at the sides determines the refined aesthetic of this product. Duna is made with a sophisticated cementitious compound in earthy colours, such as pale or dark grey granite and red stone, as if designed by the hot desert wind. Duna's design expresses pure essentialism, drawing inspiration from forms found in nature.





TECHNICAL INFORMATION



Plafone con montatura in cemento.
Finitura grigio chiaro, grigio
scuro o rosso. Lampadina non inclusa /
Ceiling lamp with concrete frame.
Light grey, dark grey or red finish.
Bulb not included.

**DUNA P**

Socket: **1xGu10**
Power: **max 35W**
Input: **220/240V**
Pack: **0,002 m³**



FINISHING

-  Grigio chiaro / Light grey
-  Grigio scuro / Dark grey
-  Rosso / Red

ALICE

Elegante, ricercata, unica.

ALICE una sospensione caratterizzata dalla particolarissima lavorazione in vetro balloton, realizzata dalle sapienti mani dei nostri maestri vetrai.

Disponibile in due misure, propone le nuovissime colorazioni fumè ed ambra con velature e riflessi con effetto specchio oltre all'immancabile bianco sfumato.

La bellezza del vetro e i riflessi di luce rendono suggestivo ogni ambiente.

Elegant, refined, unique. ALICE: pendant light featuring very particular balloton glass processing by the skilled hands of our glass masters. Available in two sizes, it offers the brand new smoky and amber colours with glazes and reflections with mirror effect, as well as the inevitable shaded white. The beautiful glass and the light reflections turn every space







Esempio d'ordine: **ALICE M S/P Nero n.1 + ALICE V/P Fumè n.1 / ALICE M S/P Ottone n.1 + ALICE V/P Ambra n.1**

Order exampe: **ALICE M S/P Black n.1 + ALICE V/P Smoked n.1 / ALICE M S/P Brass n.1 + ALICE V/P Amber n.1**



TECHNICAL INFORMATION

Sospensioni con montatura in metallo. Finiture: Bianco opaco; Ottone; Nero opaco. Vetro con decorazione a sfumare trasparente. Finiture: Bianco; Ambra; Grigio fumè. Lampadine non incluse. N.B. La montatura piccola (ALICE M S/P) è da abbinare al vetro piccolo (ALICE V/P). La montatura grande (ALICE M S/G) è da abbinare al vetro grande (ALICE V/G) / Glass with faded and transparent decorations. Available finishes: white; amber; smoky grey. N.B. The small frame (Alice M S/P) is to be combined with the small glass (Alice V/P). The large frame (Alice M S/G) is to be combined with the large glass (Alice V/G).

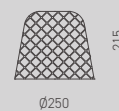
**ALICE V/P**Pack: **0,0279 m³****ALICE M S/P**

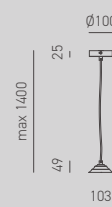
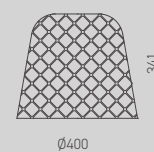

Socket: **1xE27**
 Power: **max 60W**
 input: **220/240V**
 Pack: **0,0037 m³**

**ALICE V/G**Pack: **0,088 m³****ALICE M S/G**

Socket: **1xE27**
 Power: **max 60W**
 input: **220/240V**
 Pack: **0,0037 m³**



FINISHING

-  Ottone / Brass
-  Nero Opaco / Black Matt
-  Bianco Opaco / White Matt

GLASSES

-  Ambra / Amber
-  Fumè / Smoked
-  Bianco / White

Nessuna montatura è abbinata ai vetri, sono a libera scelta / No frame is combined with the glasses, they can be chosen freely.



ALICE COMPOSIZIONI

È un modo di fare illuminazione sempre più apprezzato. Permette infatti di installare a soffitto più punti luce con possibilità di creare composizioni simmetriche o asimmetriche che permettono quest'ultime, di decentrare la luce e personalizzare a piacere l'ambiente. Disponibile nelle versioni a 3 o 6 luci con montatura a plafone circolare oppure a 3 luci con montatura lineare rettangolare.

It is an increasingly appreciated lighting technique. It allows the installation of additional ceiling light points to create symmetrical or asymmetrical compositions - by using cable hooks - and customise the environment as desired. Available in 3 or 6 light versions with circular ceiling mount or 3 lights with rectangular linear mount





Sospensione circolare a 3 luci nella composizione simmetrica a grappolo. Nella pagina accanto nella versione a grappolo con estensione asimmetrica laterale di 2 punti luce.

3-light circular pendant with symmetrical cluster composition. The page opposite shows the cluster version with asymmetrical lateral extension of 2 light points



Esempio d'ordine: **ALICE B T/3 Nero n.1 + GSOBL11 n.3 + ALICE M SR/P Nero n.3 + ALICE V/P Fumè n.3**
 Order examp: **ALICE B T/3 Black n.1 + GSOBL11 n.3 + ALICE M SR/P Black n.3 + ALICE V/P Smoked n.3**





Sospensione circolare a 6 luci nella composizione asimmetrica a grappolo. Nella pagina accanto composizione con installazione decentrata con estensione laterale di più punti luce.

6-light circular pendant with asymmetrical cluster composition. Page opposite: configuration with a decentralised installation featuring a lateral extension of several light points.



Esempio d'ordine: **ALICE B T/6 Ottone n.1 + GSOBL12 n.5 + ALICE M SR/P Ottone n.6 + Alice V/P Ambra n.6**

Order example: **ALICE B T/6 Brass n.1 + GSOBL12 n.5 + ALICE M SR/P Brass n.6 + Alice V/P Amber n.6**





Sospensione lineare a 3 luci nella composizione simmetrica con diffusori a varie altezze. Nella pagina accanto composizione con installazione decentrata con estensione laterale di un punto luce.

3-light linear pendant with a symmetrical composition with diffusers at various heights. Page opposite: configuration with a decentralised installation featuring a lateral extension of one light point.



Esempio d'ordine: **ALICE B R/3 Nero n.1 + ALICE M SR/P Nero n.3 + ALICE V/P Fumè n.3**
 Order example: **ALICE B R/3 Black n.1 + ALICE M SR/P Black n.3 + ALICE V/P Smoked n.3**



TECHNICAL INFORMATION

Vetro con decorazione a sfumare trasparente.
Finiture: Bianco; Ambra;
Grigio fumè /



Glass with faded and transparent effects.
Available finishes: white;
amber; smoky grey.

**ALICE V/P**

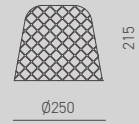
Pack: **0,0279 m³**



GLASSES

-  Bianco / White
-  Ambra / Amber
-  Fumè / Smoked

TECHNICAL INFORMATION

Montatura in metallo senza rosone dotata di cavo elettrico di lunghezza 3 metri. Lampadina non inclusa. Finitura: Bianco opaco, ottone o nero opaco / Metal frame without canopy equipped with 3 meter long electric cable. Bulb not included. Finishes: Matt white; brass or matt black.

**ALICE M SR/P**

Socket: **1xE27**
Power: **max 60W**
input: **220/240V**
Pack: **0,0025 m³**

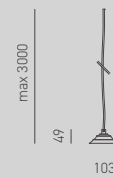

Rosone rettangolare a tre fori in metallo con staffa ed accessori per il fissaggio inclusi. Inclusi tre pressacavi e morsettiera elettrica. Finiture: Bianco opaco, ottone o nero opaco / Three-hole, rectangular metal ceiling rose with bracket and fixing accessories included. Includes three cable glands and electrical terminal block. Finishes: Matt white; brass or matt black.

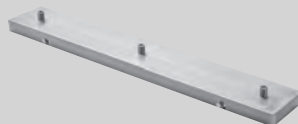
**ALICE B R/3**

Pack: **0,0059 m³**

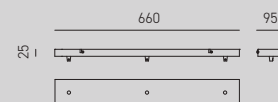

Rosone a tre fori in metallo con staffa ed accessori per il fissaggio inclusi. Inclusi tre pressacavi e morsettiera elettrica. Finiture: Bianco opaco, ottone o nero opaco / Three-hole metal ceiling rose with bracket and fixing accessories included. Includes three cable glands and electrical terminal block. Finishes: Matt white; brass or matt black.

**ALICE B T/3**

Pack: **0,0092 m³**

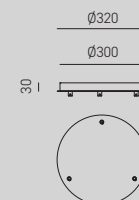

Rosone a tre fori in metallo con staffa ed accessori per il fissaggio inclusi. Inclusi tre pressacavi e morsettiera elettrica. Finiture: Bianco opaco, ottone o nero opaco / Six-hole metal ceiling rose with bracket and fixing accessories included. Includes six cable glands and electrical terminal block. Finishes: Matt white; brass or matt black.

**ALICE B T/6**

Pack: **0,027 m³**

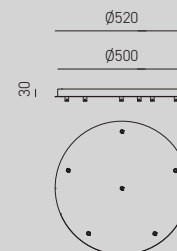

Decentratore in metallo con aggancio e fissaggio con grano per cavi in stoffa 2x0,75mm. Finiture: Bianco opaco, ottone o nero opaco / Metal decentralizer with hook and dowel fitting for 2x0.75mm fabric cables. Finishes: Matt white; brass or matt black.



GSOBL10 Bianco Opaco / White Matt
GSOBL11 Nero Opaco / Black Matt
GSOBL12 Ottone / Brass
Pack: **0,00019 m³**

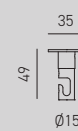



Decentratore in metallo con regolazione per cavi elettrici / Metal decentralizations with adjustment for electric cables.



GSOBL01 Bianco Opaco / White Matt
GSOBL02 Nero Opaco / Black Matt
GSOBL03 Ottone / Brass
Pack: **0,00002 m³**



FINISHING

-  Bianco Opaco / White Matt
-  Nero Opaco / Black Matt
-  Ottone / Brass



CLEOFE

Eclettica nello stile, certamente raffinata nei toni e nella scelta dei colori. Una vera cascata di luci e forme differenti accomunate da una particolare lavorazione artistica del vetro con la decorazione in rilievo sviluppata a spina di pesce. Tre i diffusori presentati declinabili nelle quattro splendide colorazioni del vetro.

Stylistically eclectic, Cleofe is certainly sophisticated in the tones and range of colours. A true cascade of varying lights and shapes united by a special artistic processing technique, where the glass is decorated with a herringbone pattern in relief. Three glass diffusers are presented, which can be expressed in four splendid colours.













TECHNICAL INFORMATION

Sospensioni con montatura in metallo.
 Finiture: Metallo bianco opaco con vetro bianco opale; Metallo nero opaco con vetro cobalto trasparente;
 Metallo ottone con vetro ambra trasparente;
 Metallo cromo con vetro ocra trasparente.
 Lampadine non incluse./
 Suspension lighting with metal frame.
 Finishes: Matt white metal with opal white glass; Matt black metal with transparent cobalt glass;
 Brass metal with transparent amber glass;
 Chrome metal with transparent ochre glass. Bulbs not included.

**CLEOFE S/10**

Socket: **1xE27**
 Power: **max 60W**
 Input: **220/240V**
 Pack: **0,035 m³**

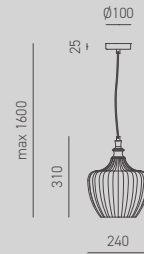
**CLEOFE S/11**



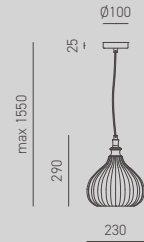

Socket: **1xE27**
 Power: **max 60W**
 Input: **220/240V**
 Pack: **0,028 m³**

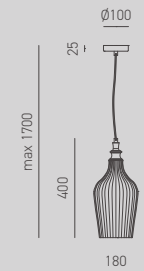
**CLEOFE S/12**





Socket: **1xE27**
 Power: **max 60W**
 Input: **220/240V**
 Pack: **0,025 m³**



FINISHING

-  Bianco Opaco / White Matt
-  Nero Opaco / Black Matt
-  Ottone / Brass
-  Cromo / Chrome

GLASSES

-  Bianco Opale / Opal White
-  Cobalto / Cobalt
-  Ambra Trasparente / Transparent Amber
-  Ocra / Ochre

TECHNICAL INFORMATION



Sospensioni con montatura in metallo.
 Finiture: Metallo bianco opaco con vetri bianco opale; Metallo ottone con vetri ambra trasparente; Metallo nero opaco con 1 vetro ambra trasparente, 1 vetro ocra ed 1 vetro cobalto. Le combinazioni di vetri e montature sono quelle illustrate e non sono modificabili. Lampadine non incluse / Suspension lighting with metal frame.
 Finishes: Matt white metal with opal white glass; Brass metal with transparent amber glasses; Matt black metal with 1 transparent amber glass, 1 ochre glass and 1 cobalt glass. The combinations of glasses and frames are those shown and cannot be changed.

**CLEOFE S/3**





Socket: **3xE27**
 Power: **max 3x60W**
 Input: **220/240V**
 Pack: **0,142 m³**



FINISHING

-  Bianco Opaco / White Matt
-  Ottone / Brass
-  Nero Opaco / Black Matt

GLASSES

-  Bianco Opale / Opal White
-  Ambra Trasparente / Transparent Amber
-  Ocra / Ochre
-  Cobalto / Cobalt
-  Ambra Trasparente / Transparent Amber



Sospensioni con montatura in metallo.
 Finiture: Metallo bianco opaco con vetri bianco opale; Metallo nero opaco con 2 vetri ambra trasparente, 2 vetri ocra e 2 vetri cobalto. Le combinazioni di vetri e montature sono quelle illustrate e non sono modificabili. Lampadine non incluse / Suspension lighting with metal frame.
 Finishes: Matt white metal with opal white glass; Matt black metal with transparent amber glass x 2, ochre glass x 2 and cobalt glass x 2. The combinations of glasses and frames are those shown and cannot be changed.
 Bulbs not included.

**CLEOFE S/6**

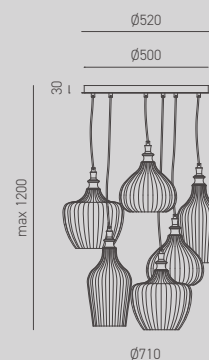



Socket: **6xE27**
 Power: **max 6x60W**
 Input: **220/240V**
 Pack: **0,251 m³**



FINISHING

-  Bianco Opaco / White Matt
-  Nero Opaco / Black Matt

GLASSES

-  Bianco Opale / Opal White
-  Ocra / Ochre
-  Cobalto / Cobalt
-  Ambra Trasparente / Transparent Amber

FABIANA

Sapiente lavorazione del vetro soffiato con una particolare superficie in bassorilievo che caratterizza la collezione FABIANA. Una forma organica disponibile in due misure, che cattura per il suo design e lo stile. Le colorazioni del vetro oltre all'intramontabile bianco, sono disponibili nelle varianti ambra o fumè con la particolarissima finitura specchio.

The hallmark of the FABIANA collection is the masterful processing of blown glass with a particular bas-relief surface. This organic shape, with an eye-catching design and style, is available in two sizes. Available glass colours include the timeless white plus amber or smoky variants with a very special mirror finish.







TECHNICAL INFORMATION

Sospensioni con montatura in metallo.

Finiture: Metallo bianco opaco con vetro bianco opale; Metallo ottone con vetro ambra trasparente; Metallo nero opaco vetro grigio fumè.

Lampadine non incluse / Pendant light with metal frame.

Available finishes: matt white metal with opal white glass; brass metal with transparent amber glass; matt black metal with smoked grey glass.

Bulbs not included.



FABIANA S/P

Socket: **1xE27**
 Power: **max 1x60W**
 input: **220/240V**
 Pack: **0,06 m³**

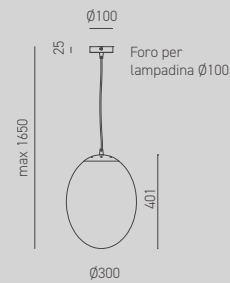



FABIANA S/G

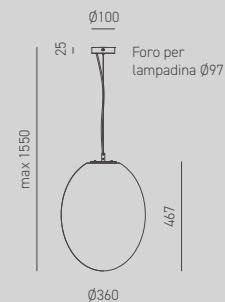

Socket: **1xE27**
 Power: **max 1x60W**
 input: **220/240V**
 Pack: **0,095 m³**



FINISHING

-  Ottone / Brass
-  Nero Opaco / Black Matt
-  Bianco Opaco / White Matt

GLASSES

-  Ambra Trasparente / Transparent Amber
-  Fumè / Smoked
-  Bianco Opale / Opal White



ELBA ESTER

Forme essenziali esaltate dalla cura estrema delle finiture.
Due sospensioni in vetro soffiato trasparente, sfumato bianco nella parte superiore: una lavorazione particolarissima che rende preziosa e unica questa serie che si identifica in ELBA per il diffusore ovale e Ester per quello sferico.

The incredibly detailed finishes enhance the minimalist shapes.
Two pendant lamps in transparent blown glass, featuring a white gradient in the upper section; the extraordinary processing technique makes this series precious and unique.
The oval diffuser identifies Elba, while Ester features a spherical one.





TECHNICAL INFORMATION

Sospensione con montatura in metallo satinato bianco.
 Diffusore in vetro bianco sfumato.
 Lampadina non inclusa; misura massima della lampadina diam. 60mm./
 Suspension with satin white metal frame.
 Frosted white glass diffuser.
 Bulb not included; maximum bulb size 60 mm diameter.

**ELBA S**

Socket: **1xE27**
 Power: **max 40W**
 Input: **220/240V**
 Pack: **0,133 m³**

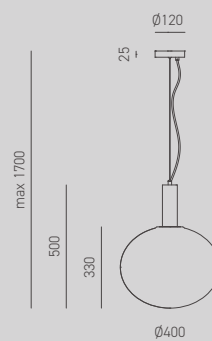
**ESTER S**

Socket: **1xE27**
 Power: **max 40W**
 Input: **220/240V**
 Pack: **0,097 m³**

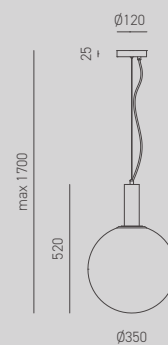

GLASSES



Bianco Satinato / Satin White



SFERA

Forme geometriche perfette danzano in un gioco di altezze e materia generando un design unico e personalizzabile. Una collezione definita da più elementi che compongono delle sospensioni ben strutturate, da collocare a diverse sommità, in cui ogni punto luce si caratterizza per un elemento in materiale cementizio e un diffusore sottostante in vetro borosilicato, soffiato, bianco opaco. Evoluzione continua.

Perfect geometric shapes intermingle in a play of varying heights and materials, creating a unique and customisable design. Sfera is a collection defined by several elements that compose well-structured pendant lamps, to be positioned at different heights. Each light point is characterised by an element in cementitious material and an underlying diffuser in opaque white borosilicate blown glass. Continuous evolution.









TECHNICAL INFORMATION

Sospensione con montatura in metallo satinato bianco. Diffusore in vetro opale agganciato ad una sfera di cemento con finitura grigio chiaro, grigio scuro o rosso. Lampadina non inclusa.



Misura massima della lampadina diam. 19 mm, h 55 mm /
Suspension with satin white metal frame. Opal glass diffuser attached to a concrete sphere with light grey, dark grey or red finish. Bulb not included. Maximum bulb size 19 mm diameter, 55 mm height

**SFERA S**

Socket: **1xG9**
Power: **max 28W (max 7W led)**
Input: **220/240V**
Pack: **0,007 m³**



FINISHING

-  Grigio chiaro / Light grey
-  Grigio scuro / Dark grey
-  Rosso / Red

Sospensione con montatura in metallo satinato bianco. Diffusore in vetro opale agganciato ad una sfera di cemento.

Finitura: 2 sfere grigio chiaro, 2 sfere grigio scuro e 2 sfere rosso. Le combinazioni di vetri e montature sono quelle illustrate e non sono modificabili. Misura massima della lampadina diam. 19 mm, h 55 mm. Lampadine non incluse / Suspension with satin white metal frame. Opal glass diffuser attached to a concrete sphere. Finish: 2 light grey spheres, 2 dark grey spheres and 2 red spheres. The combinations of glasses and frames are those shown and cannot be changed. Maximum bulb size 19 mm diameter, 55 mm height. Bulbs not included.

**SFERA S/6**

Socket: **6xG9**
Power: **max 6x28W (max 6x7W led)**
Input: **220/240V**
Pack: **0,048 m³**

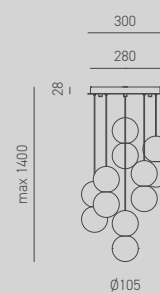

Sospensione con montatura in metallo satinato bianco. Diffusore in vetro opale agganciato ad una sfera di cemento.

Finitura: 3 sfere grigio chiaro, 4 sfere grigio scuro e 3 sfere rosso. Le combinazioni di vetri e montature sono quelle illustrate e non sono modificabili. Misura massima della lampadina diam. 19 mm, h 55 mm. Lampadine non incluse / Suspension with satin white metal frame. Opal glass diffuser attached to a concrete sphere. Finish: 3 light grey spheres, 4 dark grey spheres and 3 red spheres. The combinations of glasses and frames are those shown and cannot be changed. Maximum bulb size 19 mm diameter, 55 mm height. Bulbs not included.

**SFERA S/10**

Socket: **10xG9**
Power: **max 10x28W (max 10x7W led)**
Input: **220/240V**
Pack: **0,103 m³**

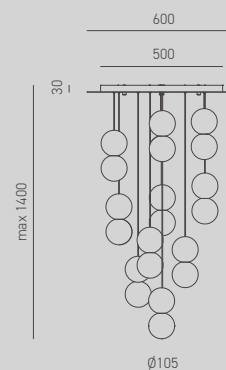



BONELLA

Caratterizzata da un'accurata lavorazione a tornio, Bonella è la lampada a sospensione dalle dimensioni generose che si distingue per la sua raffinatezza. Grazie al suo interno verniciato bianco propone un gradevolissimo chiarore, arredando ogni ambiente con naturalezza. Finiture disponibili in ottone e rame spazzolato oppure verniciato bianco o nero /

Characterised by an accurate lathe technique, Bonella is a pendant lamp with generous dimensions that stands out for its elegance. It offers a charming glow thanks to its white painted interior, and the two diameters available furnish any environment with a natural quality. Bonella is available in a choice of finishes: brass and brushed copper or painted white or black.





TECHNICAL INFORMATION



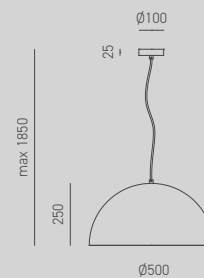

Sospensione con montatura in alluminio.
 Finiture: Bianco opaco esterno/bianco opaco interno, rosone bianco opaco.
 Nero opaco esterno/bianco opaco interno, rosone nero opaco. Ottone esterno/bianco opaco interno, rosone ottone.
 Rame esterno/bianco opaco interno, rosone rame.
 Lampadina non inclusa/
 Suspension lighting with aluminium frame.
 Finishes: Matt white outside/matt white inside, matt white canopy.
 Matt black outside/matt white inside, matt black canopy.
 Brass outside/matt white inside, brass canopy. Copper outside/matt white inside, copper canopy.
 Bulb not included.

**BONELLA S/P**

Socket: **1xE27**
 Power: **max 60W**
 Input: **220/240V**
 Pack: **0,091 m³**



FINISHING

-  Bianco-Bianco / White-White
-  Nero-Bianco / Black-White
-  Ottone-Bianco / Brass-White
-  Rame-Bianco / Copper-White



BLANCA

Una linea sempre attuale, un design che esprime carattere, uniti alla funzionalità e al comfort visivo grazie alla colorazione bianca della sezione interna.

A completare questo armonioso prodotto, la scelta di finiture ricercate come il nickel e l'ottone spazzolato unitamente al bianco e al nero opaco.

Blanca's timeless lines and its design that expresses character are combined with functionality and visual comfort thanks to the white colouring of the internal section. This harmonious product is available in a choice of sophisticated finishes such as nickel and brushed brass together with white and matt black.







TECHNICAL INFORMATION



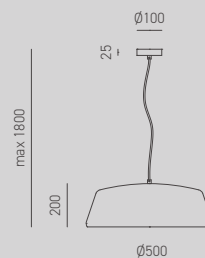

Sospensione con montatura in alluminio.
 Finiture: Bianco opaco esterno/bianco opaco interno, rosone bianco opaco.
 Nero opaco esterno/bianco opaco interno, rosone nero opaco. Ottone esterno/bianco opaco interno, rosone ottone.
 Nickel esterno/bianco opaco interno, rosone nickel. Lampadina non inclusa/
 Suspension lighting with aluminium frame. Finishes: Matt white outside/matt white inside, matt white canopy.
 Matt black outside/matt white inside, matt black canopy. Brass outside/matt white inside, brass canopy. Nickel outside/matt white inside, nickel canopy.
 Bulb not included.

**BLANCA S/P**

Socket: **1xE27**
 Power: **max 60W**
 Input: **220/240V**
 Pack: **0,076 m³**



FINISHING

-  Bianco-Bianco / White-White
-  Nero-Bianco / Black-White
-  Ottone-Bianco / Brass-White
-  Nickel-Bianco / Nickel-White





BARBIE

Forme intuitive e conosciute che si accompagnano perfettamente a qualunque ambiente, classico o moderno. Disponibile nelle finiture ottone, rame spazzolato e nei colori bianco e nero, Barbie è il complemento perfetto per la vostra casa /

Intuitive and easily recognisable shapes that perfectly match any space, classic or modern. Available in brass, brushed copper and black and white finishes, Barbie is the perfect complement to your home.





TECHNICAL INFORMATION

Sospensione con montatura in alluminio.

Finiture: Bianco opaco esterno/bianco opaco interno, rosone bianco.

Nero opaco esterno/bianco opaco interno, rosone nero opaco.

Ottone esterno/bianco opaco interno, rosone ottone.

Rame esterno/bianco opaco interno, rosone rame.

Lampadina non inclusa/

Suspension lighting with aluminium frame.

Finishes: Matt white outside/matt white inside, matt white canopy.

Matt black outside/matt white inside, matt black canopy.

Brass outside/matt white inside, brass canopy.

Copper outside/matt white inside, copper canopy.

Bulb not included.

**BARBIE S/P**



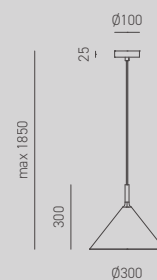

Socket: **1xE27**
 Power: **max 60W**
 Input: **220/240V**
 Pack: **0,037 m³**

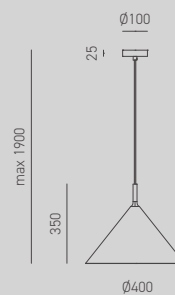
**BARBIE S/G**

Socket: **1xE27**
 Power: **max 60W**
 Input: **220/240V**
 Pack: **0,073 m³**



FINISHING

-  Bianco-Bianco / White-White
-  Nero-Bianco / Black-White
-  Ottone-Bianco / Brass-White
-  Rame-Bianco / Copper-White

BRUNA

Il design elegante e semplice dove la cura del dettaglio estremo arreda ogni ambiente con eleganza e semplicità. Da questo concept nascono le due proposte con verniciatura esterna nero opaco e interna oro, ideale per creare emozionanti atmosfere, e la bianca con interno color nickel, perfetta per ravvivare l'ambiente. Rifinite con portalampana in tinta esprimono un elevato e ricercato standard qualitativo.

The extreme attention to detail of the clean and refined design furnishes any environment with elegance and simplicity. This concept has inspired two products, one featuring a painted matt black exterior and gold interior which is ideal for creating breathtaking atmospheres, the other in white with nickel interior is perfect for invigorating a space. Finished with a matching lamp holder, Bruna expresses a superior and sophisticated quality standard.







TECHNICAL INFORMATION

Sospensione con montatura in alluminio.
 Finiture: Bianco opaco esterno/nickel opaco interno, rosone bianco opaco. Nero opaco esterno/oro opaco interno, rosone nero opaco.
 Lampadina non inclusa/
 Suspension lighting with aluminium frame. Finishes: Matt white outside/matt nickel inside, matt white canopy. Matt black outside/matt gold inside, matt black canopy.
 Bulb not included.

**BRUNA S/P**

Socket: **1xE27**
 Power: **max 60W**
 Input: **220/240V**
 Pack: **0,023 m³**

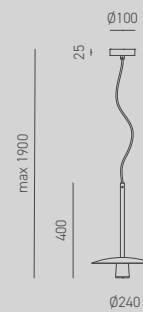
**BRUNA S/G**

Socket: **1xE27**
 Power: **max 60W**
 Input: **220/240V**
 Pack: **0,050 m³**

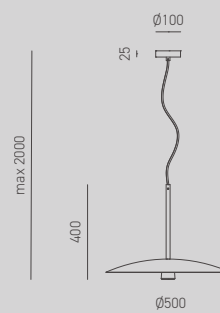

FINISHING



Bianco-Nickel / White-Nickel



Nero-Oro / Black-Gold

AMINA

Progettata come sospensione singola in 3 dimensioni o multipla con 2 soluzioni: base tonda o reglette lineare entrambe a 3 luci.

Amina rappresenta una scelta di stile inconfondibile. Disegnata da mille sfaccettature che contengono, e allo stesso tempo rilasciano, una luce affascinante e confortevole è il perfetto tocco di classe per dar vita alla vostra casa.

Designed as a single pendant lamp in 3 dimensions and as a multiple pendant lamp with 2 solutions: a round or linear base, both featuring 3 lights.

Amina represents a distinct stylistic choice. Designed with a thousand facets that contain, and at the same time release, a charming and cosy glow that makes Amina the perfect touch of class to enliven your home.









TECHNICAL INFORMATION

Sospensioni con montatura in ferro.
 Finiture in bianco ossidato, nero ossidato
 o oro ossidato con rosone in tinta.
 Lampadine non incluse/
 Suspension lighting with iron frame.
 Finishes in oxidised white, oxidised black
 or oxidised gold with matching canopy.
 Bulbs not included.

**AMINA S/P**

Socket: **1xE27**
 Power: **max 40W**
 Input: **220/240V**
 Pack: **0,013 m³**

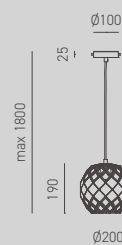
**AMINA S/M**

Socket: **1xE27**
 Power: **max 40W**
 Input: **220/240V**
 Pack: **0,034 m³**

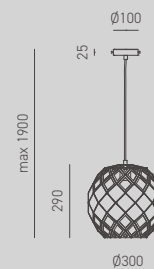
**AMINA S/G**

Socket: **1xE27**
 Power: **max 40W**
 Input: **220/240V**
 Pack: **0,078 m³**

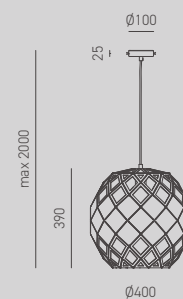
**AMINA S/T**

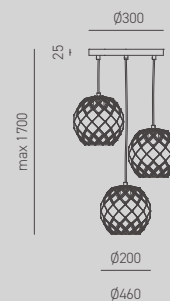

Socket: **3xE27**
 Power: **max 3x40W**
 Input: **220/240V**
 Pack: **0,066 m³**

**AMINA S/R**

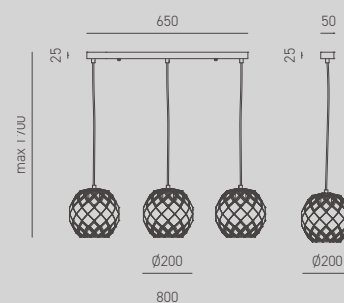
Socket: **3xE27**
 Power: **max 3x40W**
 Input: **220/240V**
 Pack: **0,052 m³**



FINISHING

-  Bianco ossidato / White oxidised
-  Nero ossidato / Black oxidised
-  Oro ossidato / Gold oxidised

ANTEA

Contrapposizione tra rigide linee perimetrali e forme circolari interne: il design minimale di Antea garantisce a questa mini serie di adattarsi ad ogni contesto, moderno o classico che sia, incorniciando la luce in uno spazio ben delimitato, eliminando qualsiasi elemento esteriore superfluo. I diffusori in vetro borosilicato soffiato consentono una luminosità esemplare.

Antea features a contrast between rigid contour lines and internal circular shapes. Its minimal design guarantees that this mini-series will adapt to any context, whether modern or classic, framing the light in a well-defined space and eliminating any superfluous external elements. The borosilicate blown glass diffusers create exemplary luminosity.



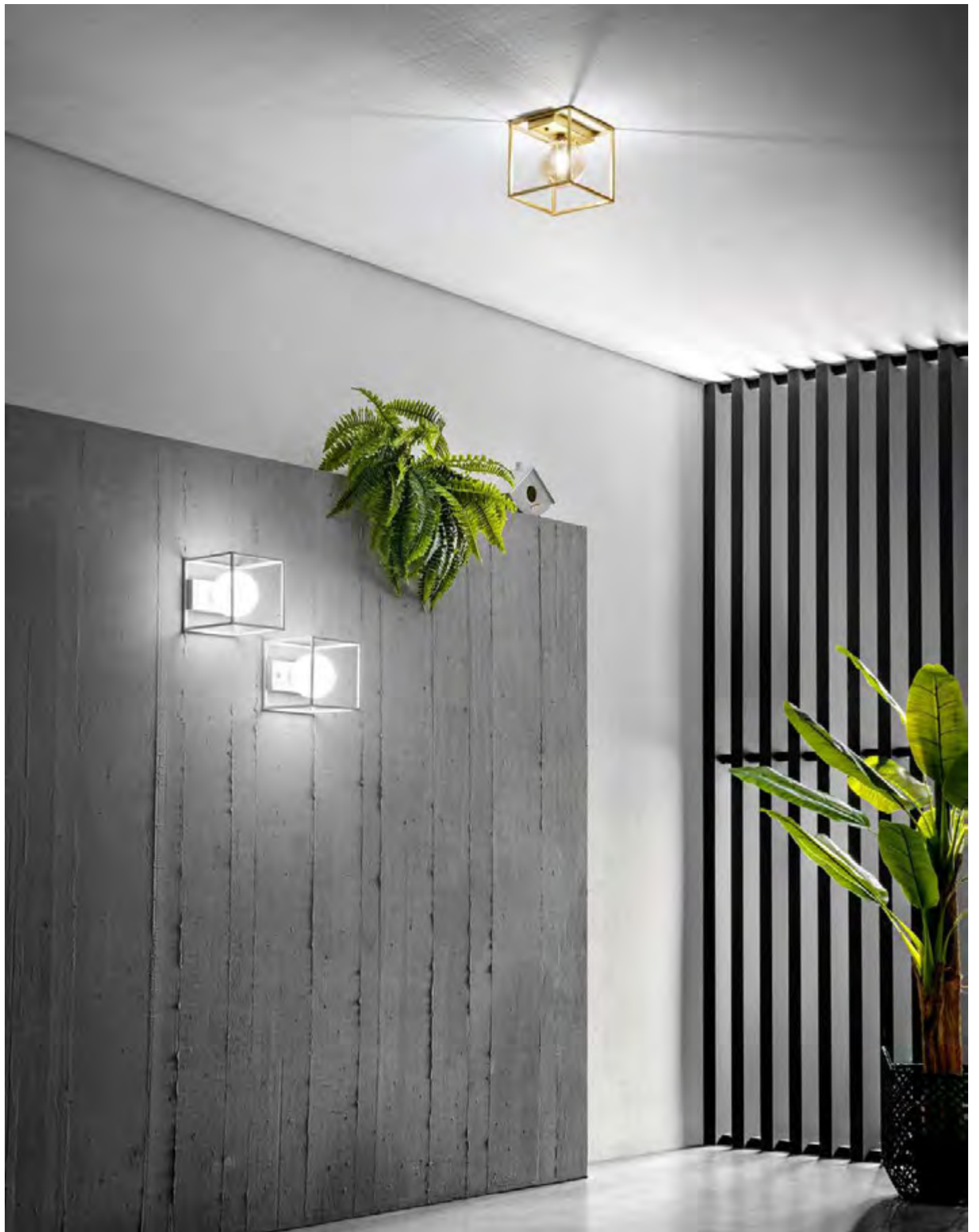







TECHNICAL INFORMATION

Montatura in ferro.

Finiture: Bianco opaco con diffusore
in vetro bianco opale;

Oro opaco con diffusore in vetro
trasparente ambrato.

Lampadine non incluse. Misura massima
della lampadina diam. 19 mm, h. 55 mm/
Ceiling lights with iron frame.

Finishes: Matt white with opal white
glass diffuser;

Matt gold with transparent amber
glass diffuser.

Bulbs not included. Maximum
bulb size 19 mm diameter, 55 mm height/

**ANTEA P/1**

Socket: **1xG9**
Power: **max 25W**
Input: **220/240V**
Pack: **0,010 m³**

**ANTEA P/3**

Socket: **3xG9**
Power: **max 3x25W**
Input: **220/240V**
Pack: **0,025 m³**

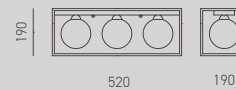
**ANTEA S/1**

Socket: **1xG9**
Power: **max 25W**
Input: **220/240V**
Pack: **0,011 m³**

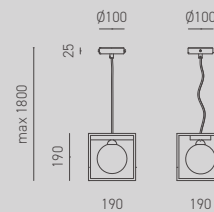
**ANTEA S/3**

Socket: **3xG9**
Power: **max 3x25W**
Input: **220/240V**
Pack: **0,028 m³**

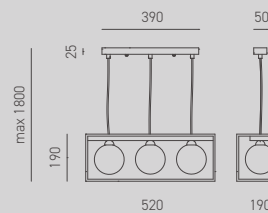

FINISHING

 Bianco Opaco / Matt white
Bianco Opale / Opal White

 Oro Opaco / Matt Gold
Trasparente Ambrato / Transparent Amber

RING

Il suo nome già ci anticipa il carattere e la forma di questo oggetto d'illuminazione che trova una sua collocazione sia da parete che da soffitto. Una forma morbida, rassicurante, non invasiva che emana luce, mettendo in risalto con tutto il suo splendore tutto ciò che le sta attorno.

Its name already anticipates the character and shape of this lighting object, which can be used both on the wall and on the ceiling. A soft, reassuring, non-invasive shape that emanates light, highlighting everything around it with all its splendour.





TECHNICAL INFORMATION

Struttura in alluminio IP44. Diffusore in materiale acrilico trasparente satinato. Finitura: bianco opaco. Modulo LED e trasformatore inclusi./ IP44 aluminium structure. Diffuser in transparent satin acrylic material. Matt white finish. LED module and transformer included.

IP44

**GAP470C**

Socket: **1 modulo LED**
 Power: **12W**
 input: **220/240V**
 Light temp.: **3000°K**
 Optic: **120°**
 Lumen: **1260Lm**
 Hours: **50.000**
 CRI: **>80**
 IP: **44**
 Pack: **0,0043 m³**

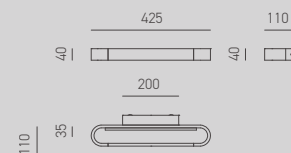
**GAP470N**

Socket: **1 modulo LED**
 Power: **12W**
 input: **220/240V**
 Light temp.: **4000°K**
 Optic: **120°**
 Lumen: **1230Lm**
 Hours: **50.000**
 CRI: **>80**
 IP: **44**
 Pack: **0,0043 m³**

FINISHING



Bianco / White

POLAR

Un forma easy, sobria, perfetta che ben si coniuga con qualunque stile ed ambiente, richiestissima sia dal privato come dal mondo contract.

Disponibile in due formati, si presta ad installazione sia longitudinale che in verticale.

An easy, sober, perfect shape that blends well with any style and environment, highly sought after by both the private and the contract sectors.

Available in two sizes, it is suitable for being installed both longitudinally and vertically.





TECHNICAL INFORMATION

Struttura in alluminio IP44. Diffusore in materiale plastico opale.

Finitura: bianco opaco o cromo.

Modulo LED e trasformatore inclusi./
IP44 aluminium structure. Opal plastic
diffuser. White or chrome finish.

LED module and transformer included.

IP44



GAP480C Bianco / White
GAP481C Cromo / Chrome

Socket: **1 modulo LED**
Power: **7W**
input: **220/240V**
Light temp.: **3000°K**
Optic: **120°**
Lumen: **640Lm**
CRI: **>80**
IP: **44**
Pack: **0,0324 m³**



GAP482C Bianco / White
GAP483C Cromo / Chrome

Socket: **1 modulo LED**
Power: **14W**
input: **220/240V**
Light temp.: **3000°K**
Optic: **120°**
Lumen: **1350Lm**
CRI: **>80**
IP: **44**
Pack: **0,0016 m³**

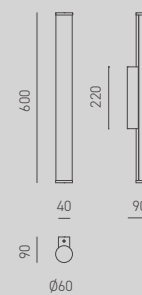

FINISHING

 Bianco / White

 Cromo / Chrome

ONE

Per noi il numero uno di gamma. Stillosa, essenziale, minimale. Rigorosa nelle geometrie e versatile nell'utilizzo, adatta per l'illuminazione da quadro o come luce da bagno. Tecnicamente all'avanguardia ed esteticamente impeccabile.

For us, the top of the range. Stylish, essential, minimal. Rigorous in its geometry and versatile in its use, suitable as lighting for a picture or as a bathroom light. Technologically advanced and aesthetically flawless.





TECHNICAL INFORMATION

Struttura in alluminio IP44. Diffusore in materiale sintetico.

Finitura: bianco opaco o nero opaco. Modulo LED e trasformatore inclusi./ IP44 aluminium structure. Synthetic diffuser.

Matt white or matt black finish. LED module and transformer included.

IP44

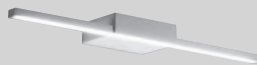

GAP490C Bianco Opaco / Matt White

GAP491C Nero Opaco / Matt Black

Socket: **1 modulo LED**
 Power: **12W**
 input: **220/240V**
 Light temp.: **3000°K**
 Optic: **120°**
 Lumen: **870Lm**
 CRI: **>80**
 IP: **44**
 Pack: **0,0034 m³**

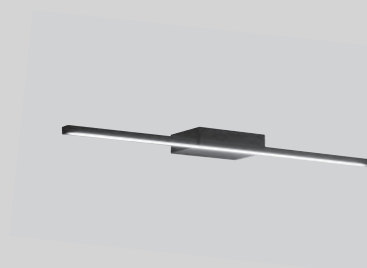
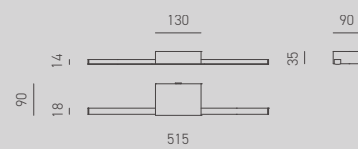

GAP492C Bianco Opaco / Matt White

GAP493C Nero Opaco / Matt Black

Socket: **1 modulo LED**
 Power: **16W**
 input: **220/240V**
 Light temp.: **3000°K**
 Optic: **120°**
 Lumen: **1670Lm**
 CRI: **>80**
 IP: **44**
 Pack: **0,0045 m³**

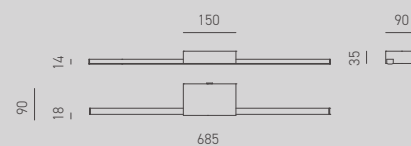

FINISHING

 Bianco Opaco / Matt White

 Nero Opaco / Matt Black



MAGIS

Una collezione di lampade da parete declinata in 3 dimensioni, con differenti temperature di luce e disponibile in svariate finiture cromatiche. Può essere installata solamente in ambienti interni ed asciutti. E' ideale come applique e come lampada da quadro. Il braccetto di piccole dimensioni consente una piccola orientabilità.

A collection of wall lamps available in 3 sizes, with different light temperatures and available in various colour finishes. It can only be installed indoors and in dry environments. It is ideal as a wall lamp and as a lamp for a picture. The small arm allows a small adjustability.





TECHNICAL INFORMATION

Struttura in metallo.
 Finitura in bianco opaco, cromo,
 nickel satinato o brunito.
 Diffusore in materiale sintetico.
 Modulo LED e trasformatore inclusi /
 Metal structure. Matt white,
 chrome, satin or burnished nickel
 finish. Synthetic diffuser,
 LED module and transforme
 included



GAP440C Nickel Satinato / Satin Nickel

GAP441C Bianco Opale / Opal White

GAP442C Cromo / Chrome

GAP443C Brunito / Antique Brass

Power: **8W**
 input: **220/240V**
 Light temp.: **3000°K**
 Optic: **120°**
 Lumen: **473Lm**
 Hours **50.000**
 CRI: **>80**
 IP: **20**
 Pack: **0,0071 m³**

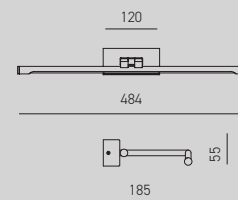

GAP440N Nickel Satinato / Satin Nickel





GAP441N Bianco Opale / Opal White

GAP442N Cromo / Chrome

GAP443N Brunito / Antique Brass

Power: **8W**
 input: **220/240V**
 Light temp.: **4000°K**
 Optic: **120°**
 Lumen: **451Lm**
 Hours **50.000**
 CRI: **>80**
 IP: **20**
 Pack: **0,0071 m³**

FINISHING

-  Nickel Satinato / Satin Nickel
-  Bianco Opale / Opal White
-  Cromo / Chrome
-  Brunito / Antique Brass

TECHNICAL INFORMATION

Struttura in metallo. Finitura in bianco opaco, cromo, nickel satinato o brunito. Diffusore in materiale sintetico. Modulo LED e trasformatore inclusi./

Metal structure. Matt white, chrome, satin or burnished nickel finish. Synthetic diffuser. LED module and transformer included./



GAP450C Nickel Satinato / Satin Nickel

GAP451C Bianco Opale / Opal White

GAP452C Cromo / Chrome

GAP453C Brunito / Antique Brass

Power: **10W**
 input: **220/240V**
 Light temp.: **3000°K**
 Optic: **120°**
 Lumen: **580Lm**
 Hours **50.000**
 CRI: **>80**
 IP: **20**
 Pack: **0,0085 m³**

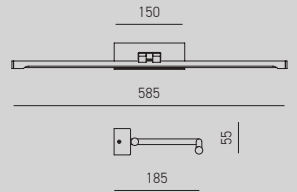

GAP450N Nickel Satinato / Satin Nickel





GAP451N Bianco Opale / Opal White

GAP452N Cromo / Chrome

GAP453N Brunito / Antique Brass

Power: **10W**
 input: **220/240V**
 Light temp.: **4000°K**
 Optic: **120°**
 Lumen: **525Lm**
 Hours **50.000**
 CRI: **>80**
 IP: **20**
 Pack: **0,0085 m³**

FINISHING

-  Nickel Satinato / Satin Nickel
-  Bianco Opale / Opal White
-  Cromo / Chrome
-  Brunito / Antique Brass

TECHNICAL INFORMATION

Struttura in metallo. Finitura in bianco opaco, cromo, nickel satinato o brunito. Diffusore in materiale sintetico. Modulo LED e trasformatore inclusi./

Metal structure. Matt white, chrome, satin or burnished nickel finish. Synthetic diffuser. LED module and transformer included./



GAP460C Nickel Satinato / Satin Nickel

GAP461C Bianco Opale / Opal White

GAP462C Cromo / Chrome

GAP463C Brunito / Antique Brass

Power: **12W**
 input: **220/240V**
 Light temp.: **3000°K**
 Optic: **120°**
 Lumen: **656Lm**
 Hours **50.000**
 CRI: **>80**
 IP: **20**
 Pack: **0,01 m³**

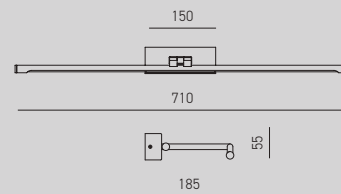

GAP460N Nickel Satinato / Satin Nickel





GAP461N Bianco Opale / Opal White

GAP462N Cromo / Chrome

GAP463N Brunito / Antique Brass

Power: **12W**
 input: **220/240V**
 Light temp.: **4000°K**
 Optic: **120°**
 Lumen: **591Lm**
 Hours **50.000**
 CRI: **>80**
 IP: **20**
 Pack: **0,01 m³**

FINISHING

-  Nickel Satinato / Satin Nickel
-  Bianco Opale / Opal White
-  Cromo / Chrome
-  Brunito / Antique Brass

MANILA

Profilo morbido, aria informale. Nell'essentialismo puro del colore bianco, Manila oltre che fonte di luce diventa vero e proprio oggetto di design, sviluppando divertenti composizioni possibili grazie alle tre dimensioni proposte.

Soft profile, informal air. In the pure essentialism of white, Manila is more than just a light source; it becomes a veritable design object. The three dimensions available allow you to develop fun compositions.







TECHNICAL INFORMATION

Montatura in alluminio verniciato bianco, diffusore in metacrilato e alluminio con finiture in bianco.

Sorgente luminosa led dimmerabile tramite dimmer esterno + push (non inclusi)./

White painted aluminium fitting, diffuser methacrylate and aluminium finished in white leaf.

Led light source. Dimmable via external dimmer + push (non included)./

**MANILA P/P**

Socket: **1 modulo LED**
 Power: **max 30W**
 Input: **220/240V**
 Lumen: **2760Lm**
 CRI: **>80**
 Light temp.: **3000°K**
 Pack: **0,027 m³**

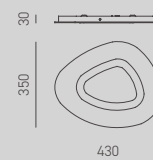
**MANILA P/M**

Socket: **1 modulo LED**
 Power: **max 35W**
 Input: **220/240V**
 Lumen: **3220Lm**
 CRI: **>80**
 Light temp.: **3000°K**
 Pack: **0,050 m³**

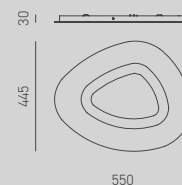
**MANILA P/G**

Socket: **1 modulo LED**
 Power: **max 45W**
 Input: **220/240V**
 Lumen: **3750Lm**
 CRI: **>80**
 Light temp.: **3000°K**
 Pack: **0,060 m³**

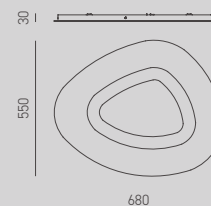

FINISHING



Bianco / White



SOLE

La sua figura piatta, quadrangolare, ingentilita da sagaci arrotondamenti, la rendono adatta a valorizzare ogni ambiente.

La versione a plafoniera è disponibile in più dimensioni, con più punti luci, mentre la stupenda sospensione permette un'illuminazione a luce diretta ed indiretta. Concisa e sofisticata allo stesso tempo.

The flat, quadrangular shape is softened by a discerning rounding of the edges, making it suitable to enhance any space. The ceiling lamp version is available in various sizes, featuring multiple light points, while the beautiful pendant lamp allows you to create direct and indirect lighting. Succinct and sophisticated at the same time.

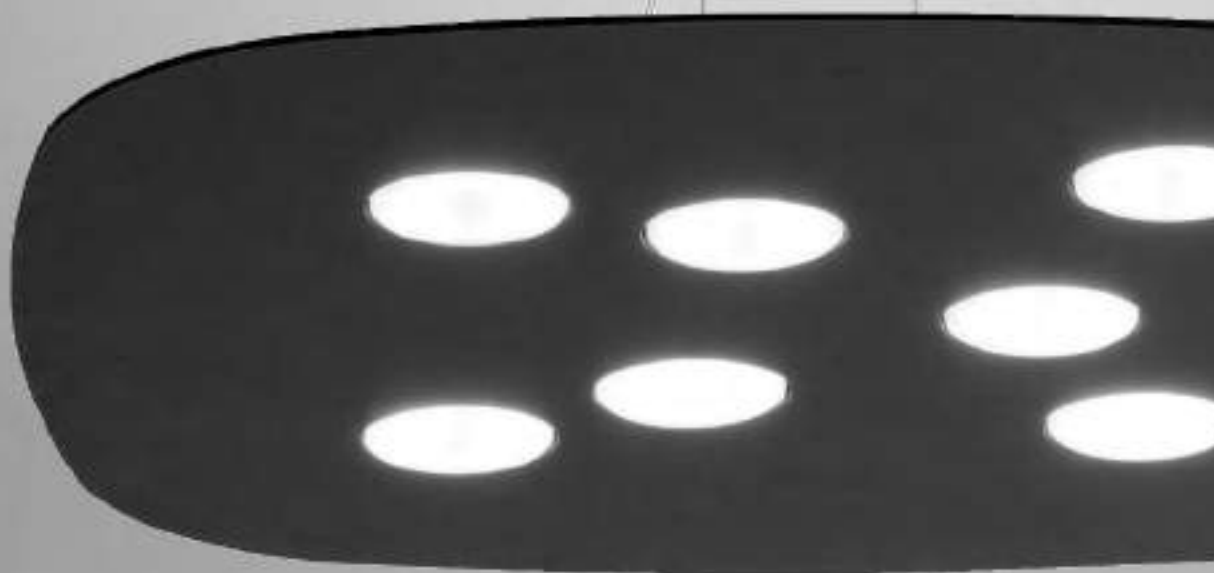



TECHNICAL INFORMATION

Montatura in metallo bianco.
 Diffusore in alluminio
 con finiture acciaio, bianco, nero.
 Sospensione con luce in biemissione.
 Rosone bianco per finiture bianco e nero.
 Rosone in tinta per finitura acciaio.
 Lampadine non incluse /
 White metal frame.

Aluminium diffuser with steel, white and
 black finishes. Suspension with two light
 sources.

White canopy for white and black finishes.
 Matching canopy for steel finish.
 Bulbs not included.

**SOLE P/P**

Socket: **3xGx53**
 Power: **max 3x8W**
 Input: **220/240V**
 Pack: **0,029 m³**

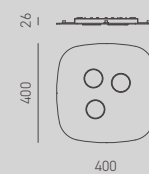
**SOLE P/M**

Socket: **5xGx53**
 Power: **max 5x8W**
 Input: **220/240V**
 Pack: **0,047 m³**

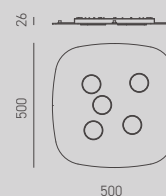
**SOLE P/G**

Socket: **7xGx53**
 Power: **max 7x8W**
 Input: **220/240V**
 Pack: **0,070 m³**

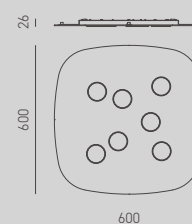
**SOLE S**

Socket: **1xGx53 up**
7xGx53 down
 Power: **max 1x8W up**
max 7x8W down
 Input: **220/240V**
 Pack: **0,070 m³**

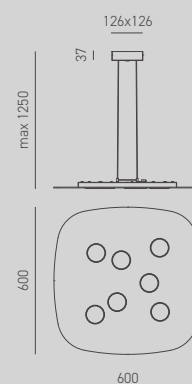

FINISHING

-  Acciaio / Steel
-  Bianco / White
-  Nero / Black

Nel riquadro sono
 raffigurati il nuovo sistema di
 aggancio delle plafoniere
 ed il sistema di biemissione
 delle sospensioni /
 In detail are shown the
 hooking system o
 the ceiling lights and
 the bi-emission system
 of the suspensions.

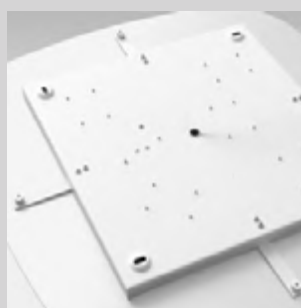





IRENE

Semplice nel concept ma ricercata nei dettagli, la caratterizza una linea asimmetrica guarnita da un inserto cromatico perfetto per esaltare il dettaglio del punto luce. Declinata nei colori bianco, nero, oro nelle varianti a sospensione e a plafoniera, Irene porta brio nella tua casa con la sua verve innata.

A simple concept that features sophisticated details; Irene is characterised by an asymmetrical line adorned with a colour insert that perfectly enhances the detail of the light point. Available in white, black, gold in the pendant and ceiling lamp variants, Irene brings liveliness to your home with its innate verve.







TECHNICAL INFORMATION

Montatura in metallo bianco.
 Diffusore in alluminio
 con finiture bianco/acciaio e nero/oro.
 Sospensione con luce in biemissione.
 Rosone bianco per finitura bianco/acciaio.
 Rosone nero per finitura nero/oro.
 Lampadine non incluse /
 White metal frame.
 Aluminium diffuser with white/steel
 and black/gold finishes.
 Suspension with two light sources.
 White canopy for white/steel finishes.
 Black canopy for black/gold finishes.
 Bulbs not included.

**IRENE P/P**

Socket: **3xGx53**
 Power: **max 3x8W**
 Input: **220/240V**
 Pack: **0,029 m³**

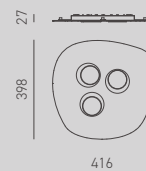
**IRENE P/M**

Socket: **5xGx53**
 Power: **max 5x8W**
 Input: **220/240V**
 Pack: **0,047 m³**

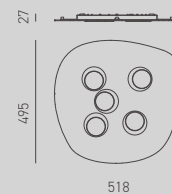
**IRENE P/G**

Socket: **7xGx53**
 Power: **max 7x8W**
 Input: **220/240V**
 Pack: **0,070 m³**

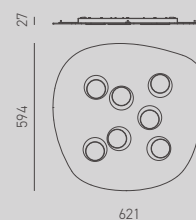
**IRENE S**

Socket: **1xGx53 up**
7xGx53 down
 Power: **max 1x8W up**
max 7x8W down
 Input: **220/240V**
 Pack: **0,070 m³**

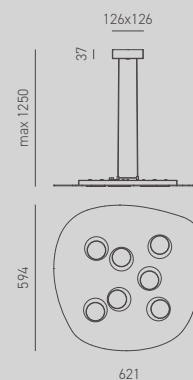

FINISHING

 Bianco-Acciaio / White-Steel

 Nero-Oro / Black-Gold

Nel riquadro sono raffigurati il nuovo sistema di aggancio delle plafoniere ed il sistema di biemissione delle sospensioni / In detail are shown the hooking system o the ceiling lights and the bi-emission system of the suspensions.

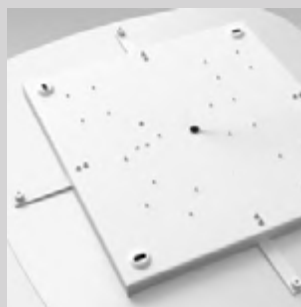





LUNA

Dolcezza ricercata nelle sue forme circolari concentriche e nelle superfici levigate. Luna riempie ogni stanza col suo stile essenziale, da sola o giocando a comporre disposizioni divertenti con le sue tre varianti di dimensione nella versione da soffitto.

Luna expresses sophisticated sweetness in its concentric circular shapes and smooth surfaces. Luna fills every room with its minimalist style, alone or grouped to compose fun arrangements with its three-dimensional variations in the ceiling lamp version.







TECHNICAL INFORMATION

Montatura in metallo bianco.
 Diffusore in metacrilato
 e alluminio con finiture bianco e tortora.
 Sospensione con luce in biemissione.
 Lampadine non incluse /
 White painted metal fitting. Methacrylate
 and aluminium diffuser with white and
 dove grey finish.
 Suspension with light in biemission.
 Bulbs not included.

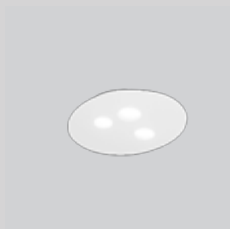
**LUNA P/P**

Socket: **3xGx53**
 Power: **max 3x8W**
 Input: **220/240V**
 Pack: **0,037 m³**

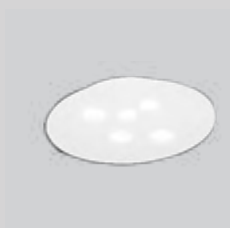
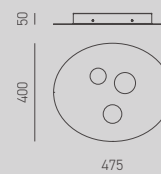
**LUNA P/M**

Socket: **5xGx53**
 Power: **max 5x8W**
 Input: **220/240V**
 Pack: **0,050 m³**

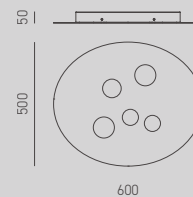
**LUNA P/G**

Socket: **7xGx53**
 Power: **max 7x8W**
 Input: **220/240V**
 Pack: **0,070 m³**

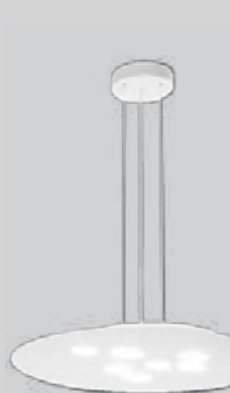
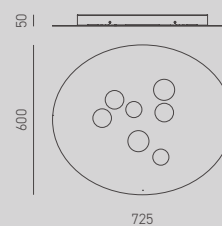
**LUNA S**

Socket: **3xGx53 up**
7xGx53 down
 Power: **max 3x8W up**
max 7x8W down
 Input: **220/240V**
 Pack: **0,070 m³**

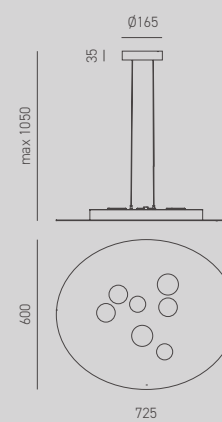

FINISHING

-  Bianco / White
-  Tortora / Dove grey

Nel dettaglio
 è raffigurato il sistema
 di biemissione
 delle sospensioni /
 In detail is shown
 the bi-emission system
 of the suspensions.



ISOTTA

Pulizia e funzionalità garantite dalla doppia emissione nella versione a sospensione, mentre la soluzione a soffitto caratterizza gli spazi per la sua adattabilità. Una collezione poliedrica, dal gusto deciso e da una grande anima.

Isotta's suspended lamp version guarantees cleanliness and functionality with its double emission, while the adaptability of the ceiling solution characterises any space. Isotta is a multifaceted collection, with a distinctive taste and a great soul.









TECHNICAL INFORMATION

Montatura in metallo bianco.
 Diffusore in metacrilato
 e alluminio con finiture bianco e tortora.
 Sospensione con luce in biemissione.
 Lampadine non incluse /
 White painted metal fitting. Methacrylate
 and aluminium diffuser with white and
 dove grey finish.
 Suspension with light in biemission.
 Bulbs not included.

**ISOTTA P/P**

Socket: **3xGx53**
 Power: **max 3x8W**
 Input: **220/240V**
 Pack: **0,033 m³**

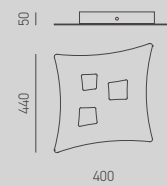
**ISOTTA P/M**

Socket: **5xGx53**
 Power: **max 5x8W**
 Input: **220/240V**
 Pack: **0,050 m³**

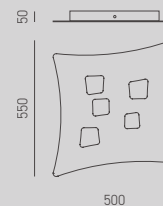
**ISOTTAP/G**

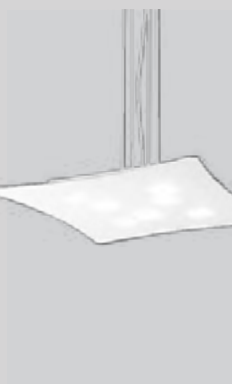
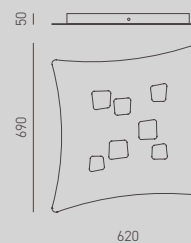

Socket: **7xGx53**
 Power: **max 7x8W**
 Input: **220/240V**
 Pack: **0,070 m³**

**ISOTTA S**

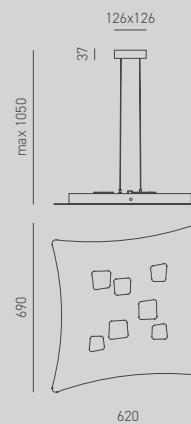
Socket: **3xGx53 up**
7xGx53 down
 Power: **max 3x8W up**
max 7x8W down
 Input: **220/240V**
 Pack: **0,070 m³**



FINISHING

-  Bianco / White
-  Tortora / Dove grey

Nel dettaglio
 è raffigurato il sistema
 di biemissione
 delle sospensioni /
 In detail is shown
 the bi-emission system
 of the suspensions.





GISELLE

Rappresenta il minimalismo perfetto. Forma quadrata sgrossata da angoli arrotondati, tasselli luminosi disposti apparentemente in modo casuale sulla superficie creano elementi aggraziati, materia e luce si fondono in un'unica sostanza. Giselle viene proposta come sospensione, con illuminazione diretta/indiretta, e come plafoniera da sette, cinque o tre luci ripartite ciascuna in tre superfici dimensionalmente diverse.

Representing perfect minimalism. Rounded corners roughen Giselle's square shape; the surface features luminous tiles seemingly arranged at random to create graceful elements where matter and light merge into a single substance. Giselle is available as a pendant lamp, with direct/indirect lighting, and as a ceiling lamp with seven, five or three lights each divided into three surfaces with varying dimensions.

Tasselli luminosi disposti
apparentemente in modo
casuale sulla superficie creano
elementi aggraziati...

Luminous pieces, seemingly
arranged at random on
the surface create graceful
elements...





TECHNICAL INFORMATION

Montatura in metallo bianco.
Diffusore in metacrilato e alluminio con finiture acciaio, bianco e tortora.
Sospensione con luce in biemissione.
Rosone bianco per finiture bianco e tortora. Rosone in tinta per finiture acciaio.

Lampadine non incluse./

White metal frame.

Diffuser in methacrylate and aluminium with steel, white and dove grey finishes.
Suspension with two light sources.

White canopy for white and dove grey finishes. Matching canopy for steel finishes.

Bulbs not included.

**GISELLE P/P**

Socket: **3xGx53**
Power: **max 3x8W**
Input: **220/240V**
Pack: **0,024 m³**

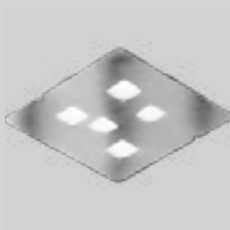
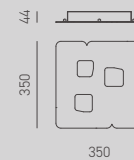
**GISELLE P/M**

Socket: **5xGx53**
Power: **max 5x8W**
Input: **220/240V**
Pack: **0,040 m³**

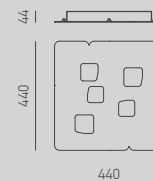
**GISELLE P/G**

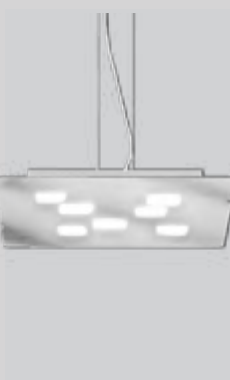
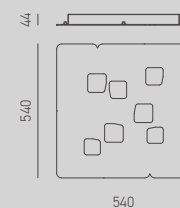

Socket: **7xGx53**
Power: **max 7x8W**
Input: **220/240V**
Pack: **0,054 m³**

**GISELLE S**

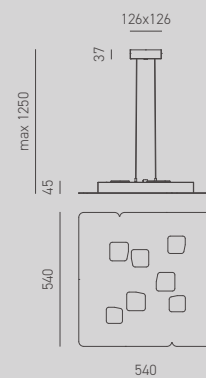
Socket: **3xGx53 up**
7xGx53 down
Power: **max 3x8W up**
max 7x8W down
Input: **220/240V**
Pack: **0,054 m³**



FINISHING

-  Acciaio / Steel
-  Bianco / White
-  Tortora / Dove grey

Nel riquadro sono raffigurati il nuovo sistema di aggancio delle plafoniere ed il sistema di biemissione delle sospensioni / In detail are shown the hooking system o the ceiling lights and the bi-emission system of the suspensions.

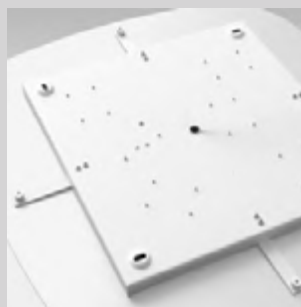

OLIMPIA

Olimpia è la naturale evoluzione della collezione Sole, quasi una sorta di estensione, con forme più longilinee e slanciate ideali per impreziosire le superfici meno generose lasciando comunque un segno distintivo. Progettata esclusivamente come plafoniera viene proposta in tre interessanti formati dimensionali.

Olimpia is the natural evolution of the Sole collection; it could almost be considered a sort of extension. The slimmer and leaner shapes are ideal for embellishing less spacious surfaces while still leaving a distinctive mark. Designed exclusively as a ceiling lamp, Olimpia is available in three attractive dimensional formats.





TECHNICAL INFORMATION

Montatura in metallo bianco.
 Diffusore in alluminio con finiture acciaio
 e bianco.
 Lampadine non incluse./
 White metal frame. Aluminium diffuser
 with steel and white finishes.
 Bulbs not included.

**OLIMPIA P/P**

Socket: **3xGx53**
 Power: **max 3x8W**
 Input: **220/240V**
 Pack: **0,026 m³**

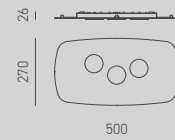
**OLIMPIA P/M**

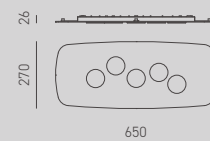

Socket: **5xGx53**
 Power: **max 5x8W**
 Input: **220/240V**
 Pack: **0,041 m³**

**OLIMPIA P/G**

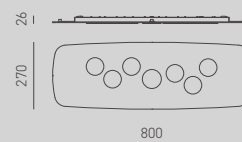
Socket: **7xGx53**
 Power: **max 7x8W**
 Input: **220/240V**
 Pack: **0,035 m³**



FINISHING

-  Acciaio / Steel
-  Bianco / White

Nel riquadro è
 raffigurato il nuovo sistema di
 aggancio delle plafoniere /
 In detail is show
 the new hooking system
 for the ceiling lights.

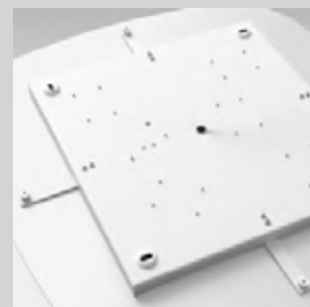



BILBAO

Morbidi quadrati si alternano danzando sulla superficie delle lampade di questa collezione dall'animo attuale, ideale per portare un tocco di design irriverente in qualsiasi ambiente. Al diffusore in metacrilato e alluminio, si aggiungono nuove finiture oro e argento ai classici bianco e tortora.

Soft squares alternate, dancing over the surface of the lamps in this collection which is characterised by a modern soul. Bilbao is ideal for bringing a touch of irreverent design to any space. New gold and silver finishes are added to the classic white and dove grey versions of the methacrylate and aluminium diffuser.





TECHNICAL INFORMATION

Montatura in metallo bianco.
 Diffusore in metacrilato
 e alluminio con finiture acciaio, bianco
 e tortora. Lampadine non incluse /
 White painted metal fitting.
 Methacrylate and aluminium diffuser
 with steel, white and
 dove grey finishes. Bulbs not
 included.

**BILBAO P/P**

Socket: **4xGx53**
 Power: **max 4x8W**
 Input: **220/240V**
 Pack: **0,025 m³**

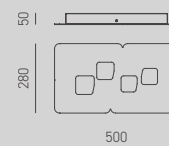
**BILBAO P/M**

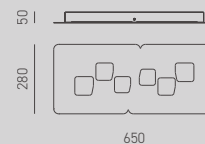

Socket: **6xGx53**
 Power: **max 6x8W**
 Input: **220/240V**
 Pack: **0,041 m³**

**BILBAO P/G**

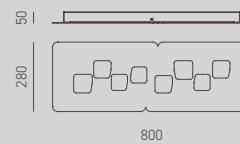
Socket: **8xGx53**
 Power: **max 8x8W**
 Input: **220/240V**
 Pack: **0,035 m³**



FINISHING

-  Acciaio / Steel
-  Bianco / White
-  Tortora / Dove grey



ARIA

Pura leggerezza in queste due vele che sembrano sostenute da una calda brezza generata dalla luce. Progettata nelle varianti bianco totale e bicolore bianco/tortora per suscitare emozione, riflessi, ombreggiature, bagliori studiati a regola d'arte.

These two sails radiate pure lightness, seemingly supported by a warm breeze generated by the light. The total white and two-tone white/dove grey variants were designed to create delightful reflections, shadows and rays of light conceived to perfection.





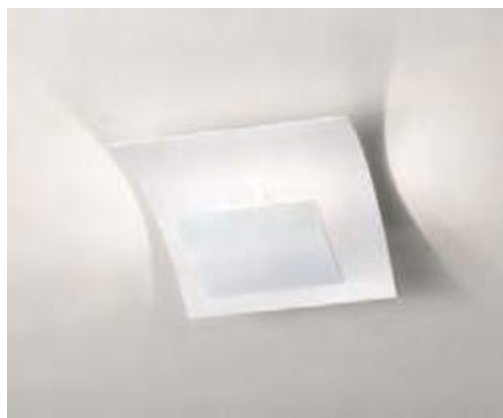



TECHNICAL INFORMATION

Montatura in alluminio bianco.
 Diffusore in metacrilato. Dissipatore
 in alluminio con finiture bianco e tortora.
 Sorgente luminosa cob led;
 Dimmerabile tramite dimmer
 esterno+push (non incluso)./
 White painted aluminium fitting.
 Methacrylate diffuser.
 Aluminium heatsink with white,
 dove grey. Cob led light
 source (push).
 Dimmable via external dimmer + push
 (not included)./

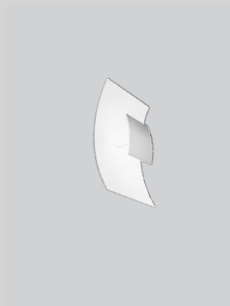
**ARIA A**

Socket: **2 moduli LED**
 Power: **20W**
 Input: **220/240V**
 Lumen: **1800Lm**
 CRI: **>80**
 Light temp.: **3000°K**
 Pack: **0,017 m³**

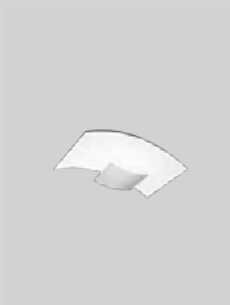
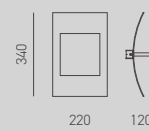
**ARIA P/P**

Socket: **2 moduli LED**
 Power: **20W**
 Input: **220/240V**
 Lumen: **1800Lm**
 CRI: **>80**
 Light temp.: **3000°K**
 Pack: **0,025 m³**

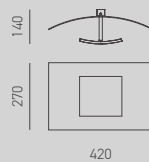
**ARIA P/M**

Socket: **2 moduli LED**
 Power: **40W**
 Input: **220/240V**
 Lumen: **3600Lm**
 CRI: **>80**
 Light temp.: **3000°K**
 Pack: **0,046 m³**

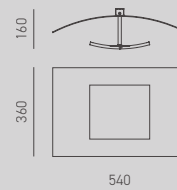
**ARIA P/G**

Socket: **2 moduli LED**
 Power: **40W**
 Input: **220/240V**
 Lumen: **3600Lm**
 CRI: **>80**
 Light temp.: **3000°K**
 Pack: **0,070 m³**

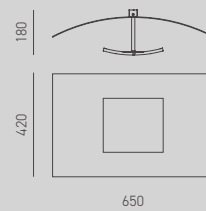

FINISHING

-  Bianco / White
-  Tortora / Dove grey

DOHA

Design rigido, linearità convenzionali
ma al contempo indefinite per
questa collezione che rievoca il cubismo
nella sua ricerca della semplificazione.
Ad arricchire il tutto nuove colorazioni.

Doha features strict design and
conventional linearity, which is
simultaneously undefined. This collection
evokes cubism in its search for
simplification.
Doha is enriched with new colours.







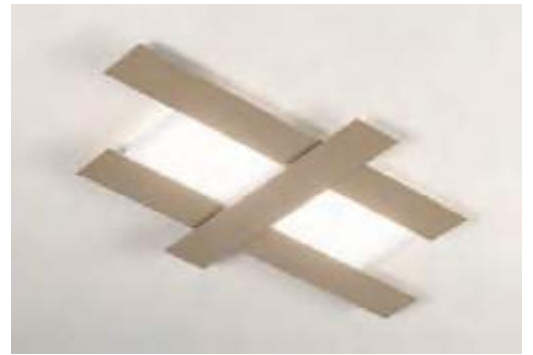
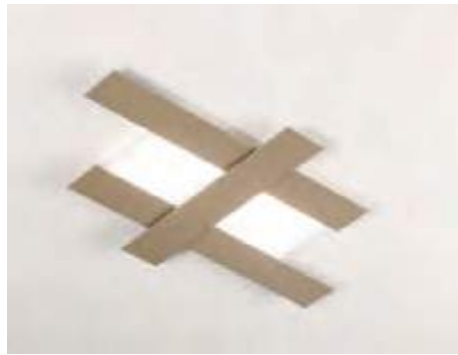
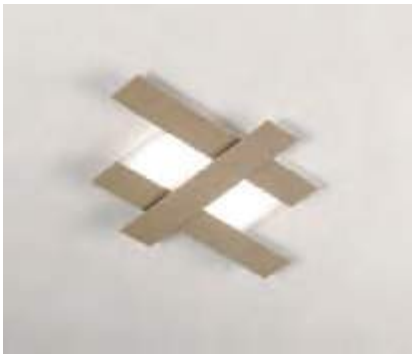







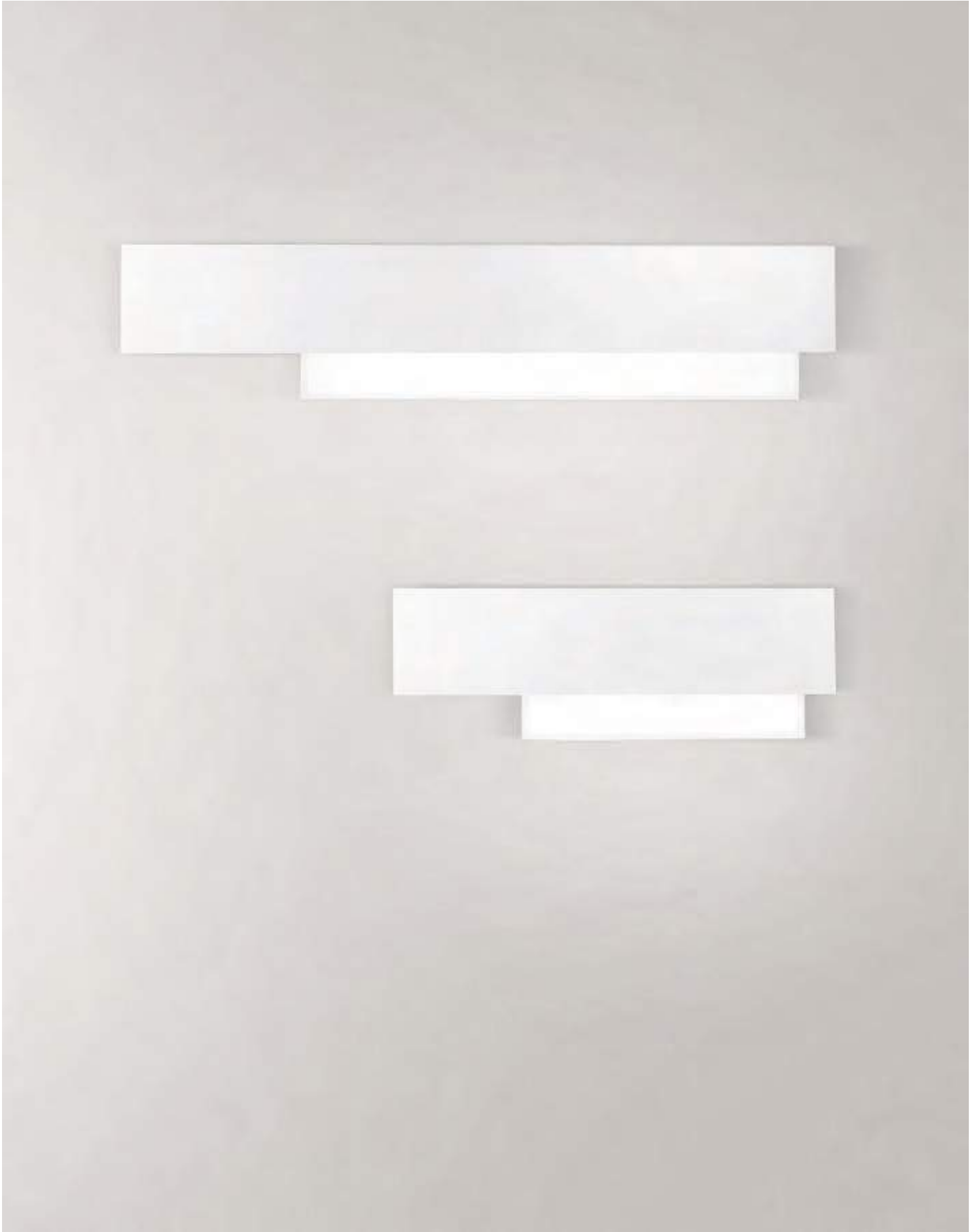





TECHNICAL INFORMATION

Montatura in alluminio bianco.
 Diffusore in metacrilato bisatinato
 e alluminio con finiture acciaio,
 bianco, nero e tortora.
 Sorgente luminosa led /
 White aluminium frame.
 Diffuser in double-coated methacrylate
 and aluminium with steel, white,
 black and dove grey finishes.
 Led light source.

**DOHA A/P**

Socket: **1 modulo LED**
 Power: **max 15W**
 Input: **220/240V**
 Lumen: **1270Lm**
 CRI: **>80**
 Light temp.: **3000°K**
 Pack: **0,013 m³**

**DOHA A/G**

Socket: **1 modulo LED**
 Power: **max 25W**
 Input: **220/240V**
 Lumen: **2110Lm**
 CRI: **>80**
 Light temp.: **3000°K**
 Pack: **0,027 m³**

**DOHA P/P**

Socket: **2 moduli LED**
 Power: **max 30W**
 Input: **220/240V**
 Lumen: **2620Lm**
 CRI: **>80**
 Light temp.: **3000°K**
 Pack: **0,029 m³**

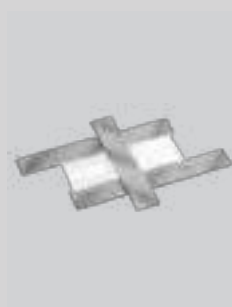
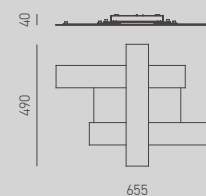
**DOHA P/M**

Socket: **2 moduli LED**
 Power: **max 40W**
 Input: **220/240V**
 Lumen: **3750Lm**
 CRI: **>80**
 Light temp.: **3000°K**
 Pack: **0,046 m³**

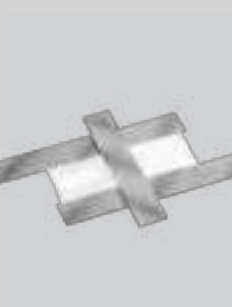
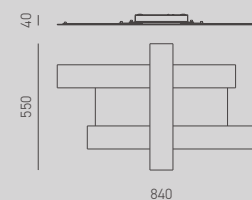
**DOHA P/G**

Socket: **2 moduli LED**
 Power: **max 50W**
 Input: **220/240V**
 Lumen: **4470Lm**
 CRI: **>80**
 Light temp.: **3000°K**
 Pack: **0,080 m³**

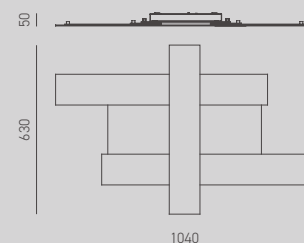

FINISHING

-  Acciaio / Steel
-  Bianco / White
-  Nero / Black
-  Tortora / Dove grey

GRACE

Il benessere visivo è assicurato dal diffusore in metacrilato bianco bisatinato, incorniciato da linee rette che si intersicano e conferiscono un'elegante ed attuale essenzialità al design. La serie si arricchisce con le nuove finiture in oro e argento oltre che alle consuete verniciature del bianco, nero e tortora.

Visual well-being is ensured by the frosted, white methacrylate diffuser, framed by straight lines that intersect and lend an elegant and contemporary simplicity to the design. The series is enriched with new finishes in gold and silver as well as the usual white, black and dove-grey paints.





TECHNICAL INFORMATION

Montatura in alluminio bianco.
 Diffusore in metacrilato bisatinato
 e alluminio con finiture acciaio,
 bianco, nero e tortora.
 Sorgente luminosa led.
 Dimmerabile tramite dimmer esterno+push
 (non incluso)./
 White aluminium frame.
 Diffuser in double-coated methacrylate
 and aluminium with steel, white,
 black and dove grey finishes.
 Led light source.
 Dimmable via external dimmer + push
 (not included)./

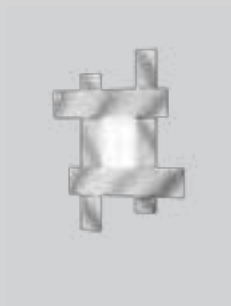
**GRACE P/P**

Socket: **1 modulo LED**
 Power: **max 25W**
 Input: **220/240V**
 Lumen: **2500Lm**
 CRI: **>80**
 Light temp.: **3000°K**
 Pack: **0,036 m³**

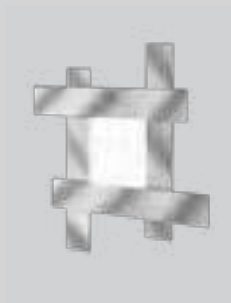
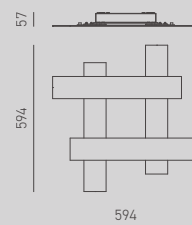
**GRACE P/M**

Socket: **1 modulo LED**
 Power: **max 39W**
 Input: **220/240V**
 Lumen: **3900Lm**
 CRI: **>80**
 Light temp.: **3000°K**
 Pack: **0,041 m³**

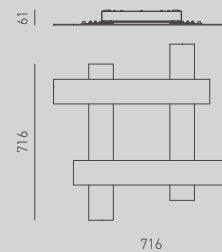
**GRACE P/G**

Socket: **1 modulo LED**
 Power: **max 56W**
 Input: **220/240V**
 Lumen: **5600Lm**
 CRI: **>80**
 Light temp.: **3000°K**
 Pack: **0,060 m³**

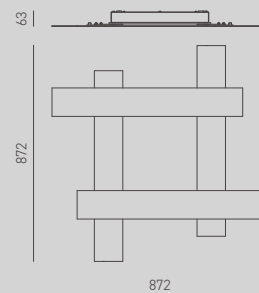

FINISHING

-  Acciaio / Steel
-  Bianco / White
-  Nero / Black
-  Tortora / Dove grey

NEKKAR

Design essenziale ma leggero, quasi ludico. Dal suo stelo sagomabile, prendono vita forme organiche sempre diverse assicurando comunque un orientamento della luce a tutto tondo. Le proporzioni della base donano stabilità e solidità a questa lampada.

Essential but lightweight design, almost playful. From its stem that is easy to shape, ever different organic forms that come to life, ensuring an all-round orientation of the light. The proportions of the base give stability and solidity to this lamp.



TECHNICAL INFORMATION

Lampada da tavolo in materiale sintetico con braccio flessibile in silicone. Interruttore ON/OFF con touch control dimmer sulla base. Modulo LED incluso. Finitura in bianco lucido, grigio lucido, nero lucido o celeste lucido./
Table lamp in synthetic material with flexible silicone arm. ON/OFF switch on the base with touch control for dimming mode. LED module included. Glossy white, glossy grey, glossy black or glossy light blue.

**GLS020** Bianco Lucido/Glossy White

Power: **5W**
input: **220/240V**
Light temp.: **3000°K**
Lumen: **350Lm**
Hours **20.000**
CRI: **>80**
Pack: **0,0048 m³**

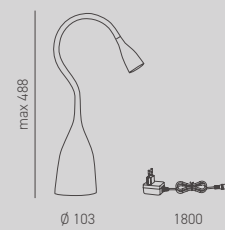
**GLS021** Grigio Lucido/Glossy Grey

Power: **5W**
input: **220/240V**
Light temp.: **3000°K**
Lumen: **350Lm**
Hours **20.000**
CRI: **>80**
Pack: **0,0048 m³**





GLS022 Nero Lucido/Glossy Black

Power: **5W**
input: **220/240V**
Light temp.: **3000°K**
Lumen: **350Lm**
Hours **20.000**
CRI: **>80**
Pack: **0,0048 m³**

GLS023 Celeste Lucido/Glossy Light Blue

Power: **5W**
input: **220/240V**
Light temp.: **3000°K**
Lumen: **350Lm**
Hours **20.000**
CRI: **>80**
Pack: **0,0048 m³**

FINISHING

-  Bianco Lucido / Glossy White
-  Grigio Lucido / Glossy Grey
-  Nero Lucido / Glossy Black
-  Celeste Lucido / Glossy Light Blue





NUNKI

Caratterizzata da curve eleganti che formano un insieme armonioso e coinvolgente. Questa lampada si adatta alle funzioni di ambienti più diversi, il suo braccio flessibile acconsente ad una mobilità strutturale che assicura sempre un comfort luminoso ideale.

Characterised by elegant curves that form a harmonious and engaging whole. This lamp adapts to the functions of the most diverse environments, its flexible arm allows for structural mobility that always provides ideal lighting comfort.

TECHNICAL INFORMATION

Lampada da tavolo in materiale sintetico con braccio flessibile in silicone. Interruttore ON/OFF sulla base con touch control che consente tre modalità di dimmerazione. Modulo LED incluso. Finitura in bianco lucido, grigio lucido, oro satinato, nero opaco o rosso lucido./ Table lamp in synthetic material with flexible silicone arm. ON/OFF switch on the base with touch control for three dimming modes. LED module included. Glossy white, glossy grey, matt gold, matt black or glossy red finish.

**GLS001** Nero Opaco/Matt Black

Power: **4,5W**
input: **220/240V**
Light temp.: **3000°K**
Lumen: **480Lm**
Hours **20.000**
CRI: **>80**
Pack: **0,0010 m³**

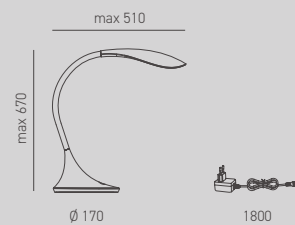
**GLS002** Bianco Lucido/Glossy White

Power: **4,5W**
input: **220/240V**
Light temp.: **3000°K**
Lumen: **480Lm**
Hours **20.000**
CRI: **>80**
Pack: **0,0010 m³**

GLS003 Rosso Lucido/Glossy Red

Power: **4,5W**
input: **220/240V**
Light temp.: **3000°K**
Lumen: **480Lm**
Hours **20.000**
CRI: **>80**
Pack: **0,0010 m³**

GLS004 Grigio Lucido/Glossy Grey





Power: **4,5W**
input: **220/240V**
Light temp.: **3000°K**
Lumen: **480Lm**
Hours **20.000**
CRI: **>80**
Pack: **0,0010 m³**

GLS005 Oro Satinato/Matt Gold

Power: **4,5W**
input: **220/240V**
Light temp.: **3000°K**
Lumen: **480Lm**
Hours **20.000**
CRI: **>80**
Pack: **0,0010 m³**



FINISHING

-  Bianco Lucido / Glossy White
-  Grigio Lucido / Glossy Grey
-  Oro Satinato / Matt Gold
-  Nero Opaco / Matt Black
-  Rosso Lucido / Glossy Red

PING-PONG

La rotazione indipendente delle due parabole permette di realizzare chiaroscuri particolari, orientando la luce in modo giocoso su una parete piuttosto che sull'altra. Sorgente di luce dai dettagli ricercati, orientabili per un'illuminazione particolarmente ricercata.

The independent rotation of the two paraboles allows you to create particular chiaroscuro, directing the light in a playful way on one wall rather than on the other. A light source with elegant details, adjustable for a particularly refined lighting.





TECHNICAL INFORMATION

Piantana dimmerabile ed orientabile con struttura in alluminio.
Finitura in bianco o nero opaco. Diffusore in vetro satinato.

Modulo LED e trasformatore incluso./
Dimmable and adjustable floor lamp with aluminium structure.

White or black matt finish. Satin glass diffuser.

LED module and transformer included./

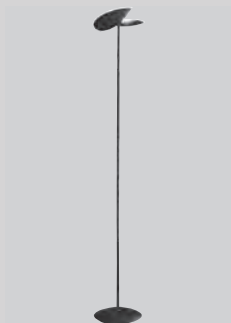
**GPIB01** Bianco Opaco / Matt White

Power: **28W**
Input: **220/240V**
Lumen: **2000Lm**
CRI: **>80**
Light temp.: **3000°K**
IP: **20**
Pack: **0,036 m³**

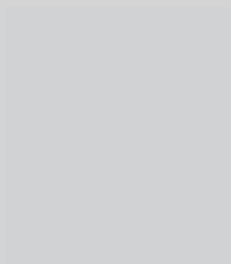
**GPIN01** Nero Opaco / Matt Black

Power: **28W**
Input: **220/240V**
Lumen: **2000Lm**
CRI: **>80**
Light temp.: **3000°K**
IP: **20**
Pack: **0,036 m³**

FINISHING



Bianco Opaco / Matt White



Nero Opaco / Matt Black



YPSILON

La leggerezza del suo design offre una presenza discreta, una purezza estetica elegantemente funzionale, e sempre attuale.

YPSILON abbina stile e funzionalità, caratterizzando gli ambienti grazie alla sua luce indiretta che genera piacevolezza e confort visivo.

The lightness of its design offers a discreet presence, an elegantly functional and always current aesthetic purity.

YPSILON combines style and functionality, giving a sense of character to the rooms thanks to its indirect light that generates pleasantness and visual comfort.



TECHNICAL INFORMATION

Piantana dimmerabile con struttura in alluminio.

Finitura in bianco o nero opaco.

Diffusore in vetro.

Modulo LED e trasformatore incluso.

Illuminazione Up&Down./

Dimmable floor lamp with aluminium structure.

White or black matt finish.

Satin glass diffuser.

LED module and transformer included.

Up&Down illumination./

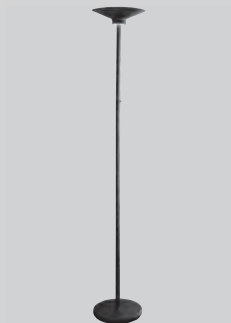
**GPIB10** Bianco Opaco / Matt White

Power UP: **48W**

Input: **220/240V**

Lumen: **3400Lm**

CRI: **>80**

Light temp.: **3000°K**

IP: **20**

Pack: **0,047 m³**

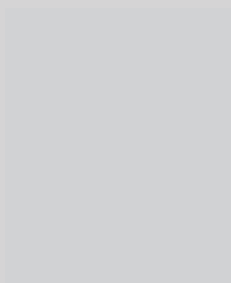
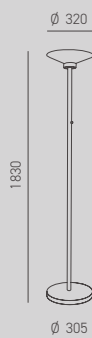
**GPIB10** Nero Opaco / Matt Black

Power UP: **48W**

Input: **220/240V**

Lumen: **3400Lm**

CRI: **>80**

Light temp.: **3000°K**

IP: **20**

Pack: **0,047 m³**

FINISHING



Bianco Opaco / Matt White



Nero Opaco / Matt Black

ZAIRA

Presenza raffinata e delicata luce diffusa caratterizzano la collezione composta da piantana e lampada da tavolo, tracciata da una lineare struttura a treppiede rifinita da un fine diffusore in tessuto. Una montatura sofisticata che ben si abbina ad ambienti classici e contemporanei.

The sophisticated presence and delicate diffused light characterise Zaira. The collection consists of a floor lamp and table lamp featuring a linear tripod structure that is refined with a fine fabric diffuser. The sophisticated frame is well suited to classic and contemporary settings.







TECHNICAL INFORMATION

Piantana e lume con montatura
in metallo con finiture bianco satinato
o nero satinato.

Paralume in tessuto bianco.

Lampadine non incluse./

Floor lamp and lamp with metal frame
with satin white or satin black finishes.

Lampshade in white fabric.

Bulbs not included.

**ZAIRA L**

Socket: **1xE27**
Power: **max 60W**
Input: **220/240V**
Pack: **0,048 m³**

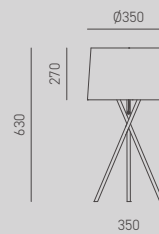
**ZAIRA PT**

Socket: **1xE27**
Power: **max 60W**
Input: **220/240 Volt**
Pack: **0,113 m³**

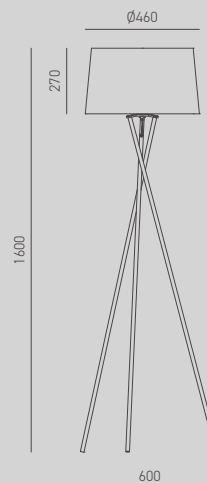

FINISHING

○ Bianco Satinato / Satin White

● Nero Satinato / Satin Black



AIDA

La particolare versione da soffitto ad arco con asta telescopica, permette il decentramento del punto di alimentazione rispetto alla superficie da illuminare, dettando un'interpretazione moderna un classico senza eguali. A dare completezza a questa singolare linea sono il paralume bianco disponibile in due diametri, e la variante a sospensione con cavo d'acciaio.

The unique arched ceiling lamp with telescopic rod allows the lamp to be decentralised from the power source with respect to the surface to be illuminated, dictating an unrivalled modern interpretation of a classic. The white lampshade, available in two diameters, and the pendant lamp variant with steel cable provide the finishing touches to this unique series.





TECHNICAL INFORMATION

Montatura con rotazione
360° estensibile in metallo
con finitura cromo.
Paralume in tessuto bianco.
Lampadine non incluse./
Metal frame with 360° rotation
with extendable metal frame
with chrome finish.
Lampshade in white fabric.
Bulbs not included.

**AIDA P/P**

Socket: **1xE27**
Power: **max 60W**
input: **220/240V**
Pack: **0,088 m³**

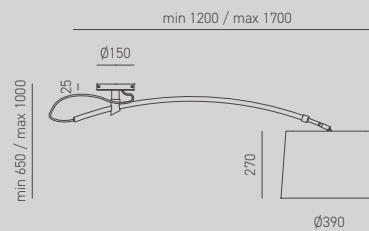
**AIDA P/G**

Socket: **1xE27**
Power: **max 60W**
input: **220/240V**
Pack: **0,128 m³**

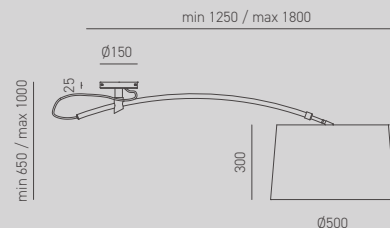
**AIDA S/P**

Socket: **1xE27**
Power: **max 60W**
input: **220/240V**
Pack: **0,052 m³**

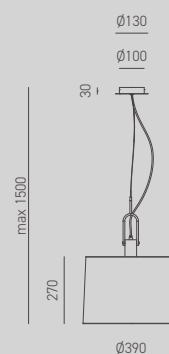
**AIDA S/G**

Socket: **1xE27**
Power: **max 60W**
input: **220/240V**
Pack: **0,092 m³**

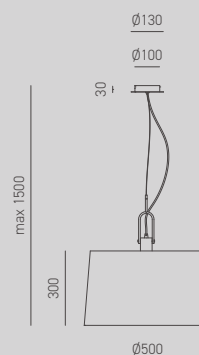

FINISHING

 Cromo - Bianco / Chrome - White

Diffusore in
metacrilato prismatico/
Prismatic
methacrylate diffuser./

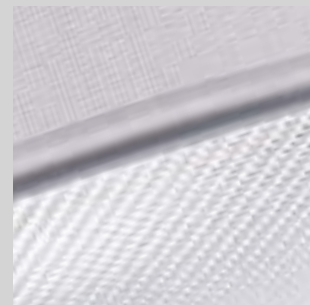



TARA

L'elegante sostegno disegnato a laser dona un elemento di prestigio alla collezione generando una struttura ricercata e versatile. Il particolare meccanismo snodato permette di orientare il paralume a piacimento conferendo uno stile informale, ma mai banale, all'apparecchio.

The elegant laser-designed support confers a prestigious element to the collection, evoking a sophisticated and versatile structure. Tara's special articulated mechanism allows you to orient the lampshade to your liking, conferring a relaxed mood that is never dull.





TECHNICAL INFORMATION

Piantana e lume con montatura in metallo con finiture bianco satinato e cromo o nero satinato e cromo.

Altezza del fusto regolabile.

Paralume inclinabile in tessuto bianco.

Lampadine non incluse /

Floor lamp and lamp with metal frame with satin white and chrome or black satin and chrome finishes.

Height-adjustable stem.

Tilting lampshade in white fabric.

Bulbs not included.

**TARA L**

Socket: **1xE27**
 Power: **max 60W**
 Input: **220/240V**
 Pack: **0,023 m³**

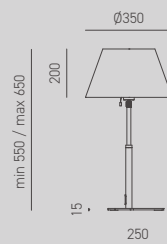
**TARA PT**

Socket: **1xE27**
 Power: **max 60W**
 Input: **220/240 Volt**
 Pack: **0,090 m³**

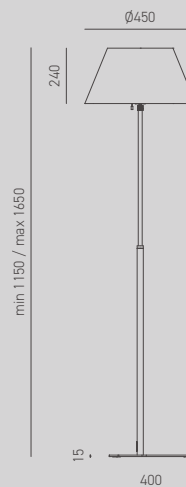

FINISHING

 Bianco satinato / Cromo
 Satin white / Chrome

 Nero satinato / Cromo
 Black satin / Chrome

SUELO

Scenari emozionanti, di sicura atmosfera, garantiti dal peculiare paralume rivestito che cela il suo diffusore.

Suelo è la sontuosa lampada da pavimento che arreda ogni ambiente con classe innata, affermando comunque la sua indole moderna attraverso la struttura in cromo regolabile in altezza.

The special lampshade covered that conceals its diffuser guarantees delightful scenarios and a safe atmosphere.

Suelo is the sumptuous floor lamp that furnishes any environment with innate class while affirming its modern character through the height-adjustable chrome structure.





TECHNICAL INFORMATION

Piantana in metallo con finiture bianco satinato e cromo o nero satinato e cromo.
 Altezza del fusto regolabile.
 Paralume in tessuto bianco con paralume nero trasparente.
 Lampadine non incluse /
 Metal floor lamp with satin white and chrome or satin black and chrome finishes. Height-adjustable stem.
 Lampshade in white fabric with transparent black lampshade.
 Bulbs not included.



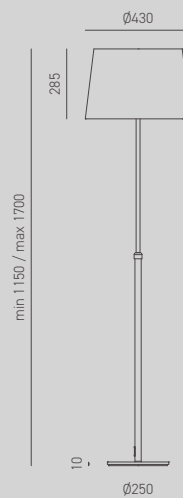

SUELO PT

Socket: **1xE27**
 Power: **max 60W**
 Input: **220/240 Volt**
 Pack: **0,098 m³**



FINISHING

 Bianco satinato / Cromo
 Satin white / Chrome

 Nero satinato / Cromo
 Black satin / Chrome



ADELA

Ancora oggi lo stile "industrial" è uno dei design più amati, soprattutto quando si tratta di arredare casa con un tocco di energia e vitalità ispirato da dettagli vintage. Adela rievoca linee di altri tempi.

"Industrial" style is still one of the most popular designs today, especially when it comes to furnishing the home with a touch of energy and vitality inspired by vintage details. Adela evokes lines from times gone by.





TECHNICAL INFORMATION

Piantana ed applique con montatura in metallo regolabile con finitura cromo ed alluminio spazzolato.

Paralume in tessuto bianco.

Lampadine non incluse./
Floor lamp and wall lamp with adjustable metal frame with chrome and brushed aluminium finish.

Lampshade in white fabric.

Bulbs not included.

**ADELA A**

Socket: **1xE27**
Power: **max 60W**
Input: **220/240V**
Pack: **0,036 m³**

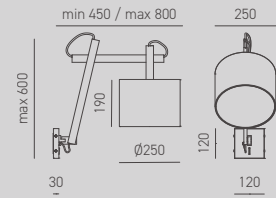
**ADELA PT**

Socket: **1xE27**
Power: **max 60W**
Input: **220/240 V**
Pack: **0,111 m³**

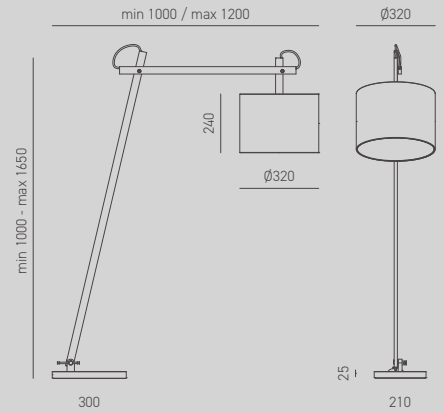

FINISHING



Cromo / Alluminio spazzolato
Chrome / Brushed Aluminium



VELIA

Un'illuminazione arcaica per stile, forme e materiali torna a essere moderna ed attuale in questa linea, grazie ad un'inusuale interpretazione stilistica. Rigorosi tratti lineari a sezione rettangolare disegnano struttura e diffusore dando vita al connubio perfetto tra design e luce.

The archaic style, shapes and materials of the lighting solution are renewed through an unusual stylistic interpretation, creating a modern and current series. The structure and diffuser are strictly linear, with a rectangular section, creating the perfect combination of design and light.





TECHNICAL INFORMATION

Piantana, lume ed applique
 con montatura in metallo
 con finitura bianco satinato.
 Paralume in tessuto bianco.
 Lampadine non incluse./
 Floor lamp, lamp and wall lamp with
 metal frame
 with satin white finish.
 Lampshade in white fabric.
 Bulbs not included.

**VELIA A**

Socket: **1xE27**
 Power: **max 60W**
 Input: **220/240V**
 Pack: **0,016 m³**

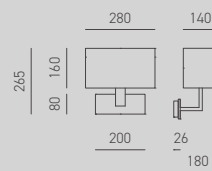
**VELIA L**

Socket: **1xE27**
 Power: **max 60W**
 Input: **220/240V**
 Pack: **0,032 m³**

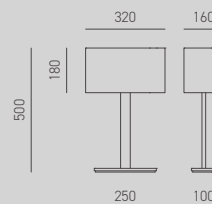
**VELIA PT**

Socket: **1xE27**
 Power: **max 60W**
 Input: **220/240 Volt**
 Pack: **0,069 m³**

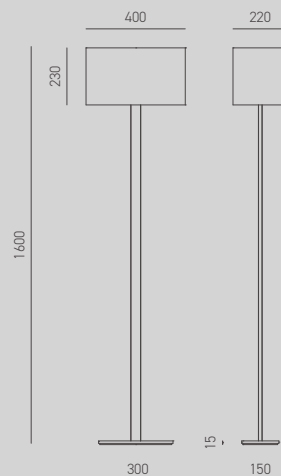

FINISHING



Bianco Satinato / Satin White





MICHELA

Linee talmente semplici e regolari da risultare istintive, danno vita alle forme di questa lampada dall'aspetto conosciuto ma al contempo perfettamente in grado di creare un legame perpetuo tra luce e superfici. Michela è un classico senza tempo.

Michela is instinctive, made up of such simple and regular lines, creating the shapes of this lamp defined by its easily recognisable appearance. At the same time, it is perfectly capable of creating an eternal bond between light and the surfaces on which it shines. Michela is a timeless classic.

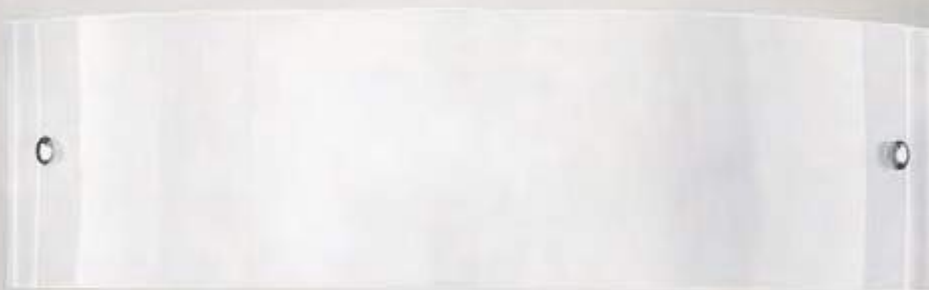



moules due Friday

bricot mi-cuit
caramel beurre salé
chewing-Gum
roseille
lique
Muguet
Myrtille
saumon rouge

for drinks etc

Strune
Pamplemousse

Dentist 10am

Eggs
for pancakes

Harnet
17th Oct
(Big 40!)

sugar
poppy seeds
peppermint
E.O.
Almonds

twinkle
twinkle...

TECHNICAL INFORMATION

Base in metallo, particolari cromo.
 Diffusore in vetro colorato bianco.
 Finitura lucida /
 Metal fitting with chrome finish.
 White coloured glass. Polish finish.

**MICHELA A/P**

Socket: **1xE27**
 Power: **max 42W**
 Input: **220/240V**
 Pack: **0,007 m³**

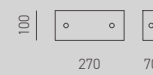
**MICHELA A/G**

Socket: **2xE14**
 Power: **max 2x28W**
 Input: **220/240V**
 Pack: **0,009 m³**

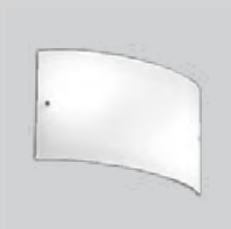
**MICHELA P/P**

Socket: **2xE27**
 Power: **max 2x42W**
 Input: **220/240V**
 Pack: **0,012 m³**

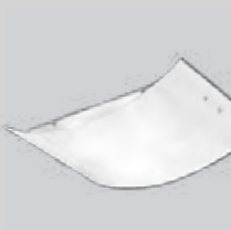
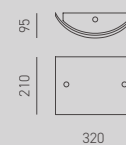
**MICHELA P/M**

Socket: **2xE27**
 Power: **max 2x52W**
 Input: **220/240V**
 Pack: **0,033 m³**

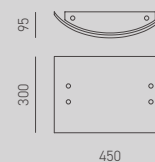

GLASSES



Bianco / White



LECCE

Pulizia estrema e pragmatismo ne plasmano il profilo trasparente. Lecce è una lampada perfetta per ogni soluzione d'arredo, sia essa classica o moderna, è in grado di decorare la casa ponendo un accento di luce delicato sull'ambiente che la accoglie.

Immaculate lines and pragmatism shape Lecce's transparent profile. Lecce is the perfect lamp to furnish any style of interior, whether it is classic or modern. It decorates the home by casting a delicate accent of light over any space it is positioned.





TECHNICAL INFORMATION

Montatura in metallo, particolari cromo.
Vetro serigrafato bianco, finitura
satinata / Chrome metal fitting.
Etched satined white glass.

**LECCE A/P**

Socket: **1xE27**
Power: **max 42W**
Input: **220/240V**
Pack: **0,007 m³**

**LECCE A/G**

Socket: **2xE14**
Power: **max 2x28W**
Input: **220/240V**
Pack: **0,009 m³**

**LECCE P/P**

Socket: **2xE27**
Power: **max 2x42W**
Input: **220/240V**
Pack: **0,012 m³**

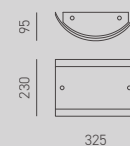
**LECCE P/M**

Socket: **2xE27**
Power: **max 2x52W**
Input: **220/240V**
Pack: **0,033 m³**

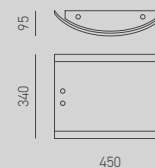

GLASSES

Bianco / White



FRIDA

Frida affascina per le trasparenze del vetro satinato ma la sua firma unica sono gli elementi centrali decorati da segni liberi.

Frida charms with its satined glass transparencies, yet its unique features are its central elements decorated with free-hand designs.

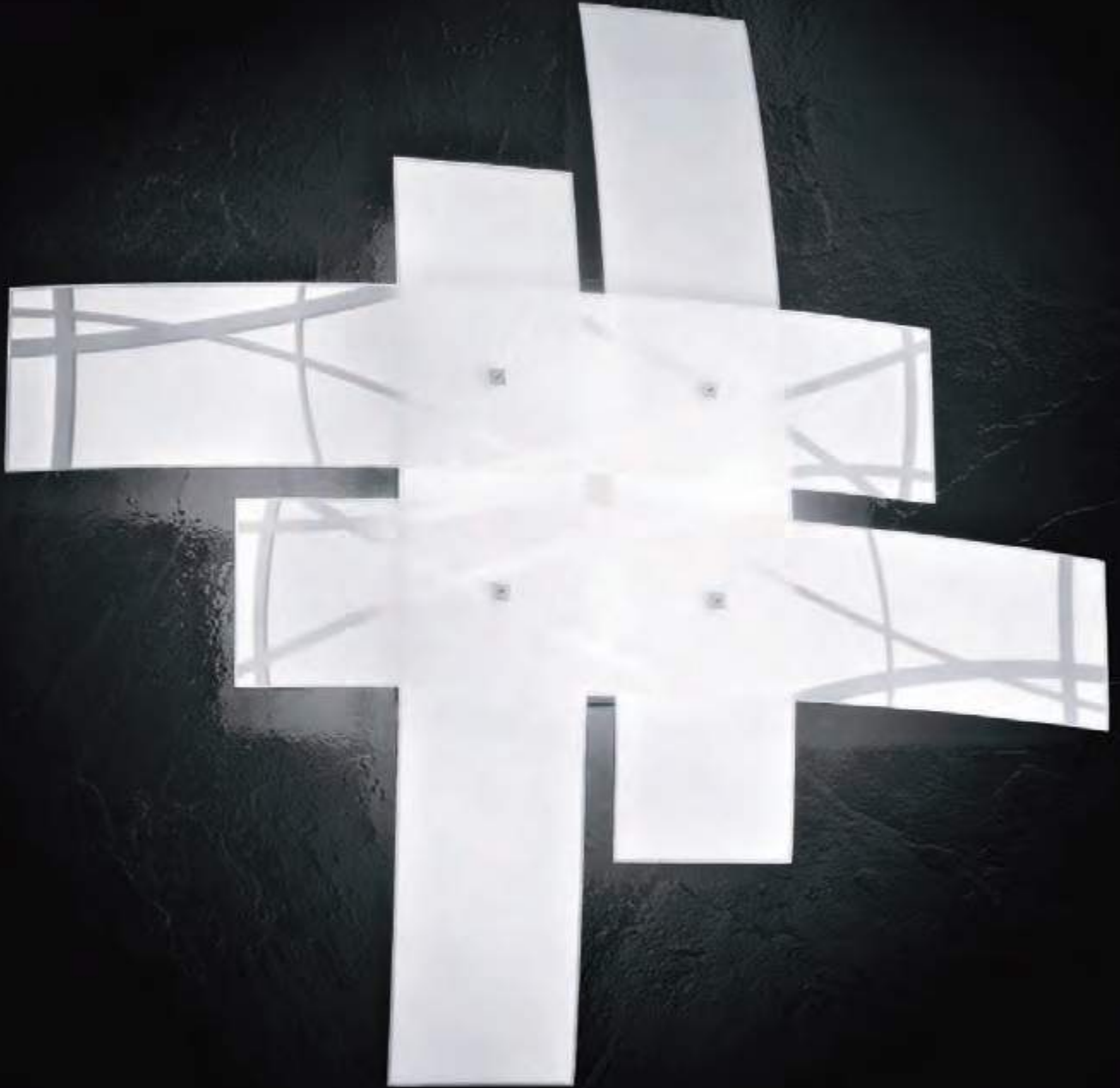







TECHNICAL INFORMATION

Montatura in metallo, finitura cromo.
 Vetri satinati e colorati in bianco.
 Finitura satinata./
 Metal fitting with chrome finish.
 Coloured and satined white glass.
 Matt finish.

**FRIDA A/P**

Socket: **2xE14**
 Power: **max 2x42W**
 Input: **220/240V**
 Pack: **0,013 m³**

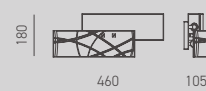
**FRIDA A/G**

Socket: **2xE14**
 Power: **max 2x42W**
 Input: **220/240V**
 Pack: **0,013 m³**

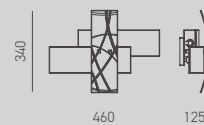
**FRIDA P/P**

Socket: **2xE27**
 Power: **max 2x52W**
 Input: **220/240V**
 Pack: **0,025 m³**

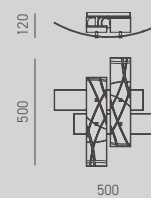
**FRIDA P/M**

Socket: **2xE27**
 Power: **max 2x70W**
 Input: **220/240V**
 Pack: **0,036 m³**

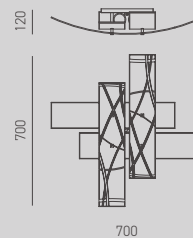
**FRIDA P/G**

Socket: **4xE27**
 Power: **max 4x52W**
 Input: **220/240V**
 Pack: **0,060 m³**

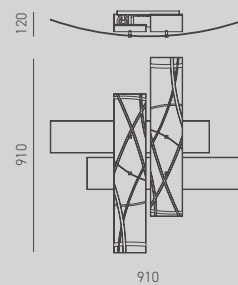

GLASSES



Bianco / White





LARA

Una sovrapposizione geometrica e cromatica dall'appeal moderno e ricercato. spazio al colore, agli abbinamenti, alla particolarità.

Overlapping shapes and colours with refined modern appeal. A focus on colour, combinations and detail.







TECHNICAL INFORMATION

Montatura in metallo con finitura cromo.
 Diffusore in vetro bianco con particolari
 foglia oro o foglia argento./
 Metal fitting with chrome finish. White
 glass with gold or silver leaf coloured
 glass. Polish finish.

**LARA A/P**

Socket: **2xE14**
 Power: **max 2x42W**
 Input: **220/240V**
 Pack: **0,012 m³**

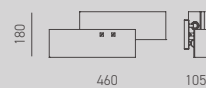
**LARA P/P**

Socket: **2xE27**
 Power: **max 2x52W**
 Input: **220/240V**
 Pack: **0,024 m³**

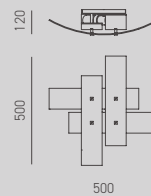
**LARA P/M**

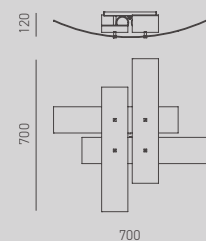

Socket: **2xE27**
 Power: **max 2x70W**
 Input: **220/240V**
 Pack: **0,035 m³**

**LARA P/G**

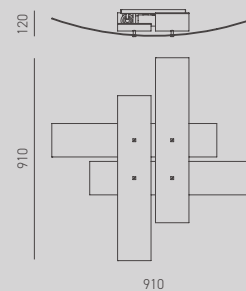
Socket: **4xE27**
 Power: **max 4x52W**
 Input: **220/240V**
 Pack: **0,06 m³**



FINISHING

-  Foglia Oro / Gold Leaf
-  Foglia Argento / Silver Leaf





PENELOPE, CAMILLA, AGNESE

Sono state per anni un must e ancora oggi risquottono un grade interesse. Sono modelli depositati, una nostra esclusiva.

Le accomuna la tecnica, si differenziano per i raffinatissimi decori e colori del vetri. Vetro che si sovrappone e si interseca in uno spettacolare rincorrersi di orbite.

They have been a must for years and still arouse great interest today. They are registered models, our exclusive. The technique unites them, they differ in the very refined decorations and colors of the glass. Glass that overlaps and intersects in a spectacular succession of orbits.



PENELOPE

Volumi che si scompongono, si intrecciano. un tocco estetico che non distrae dalle raffinate rifiniture del cromo e del vetro bianco.

Shapes that deconstruct and integrate. An aesthetic detail that does not distract from refined chrome and white glass finishes.







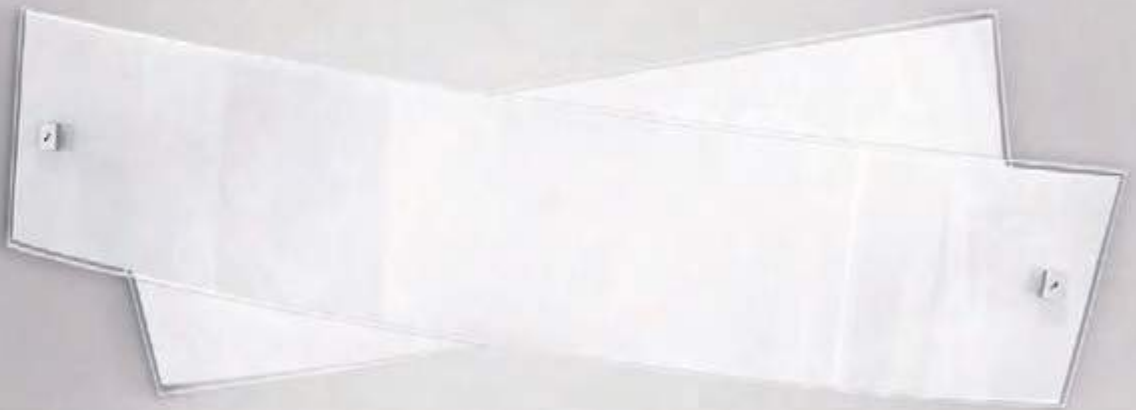



TECHNICAL INFORMATION

Montatura in metallo con finitura cromo per lumetto e sospensioni. Montatura in metallo bianco per applique e plafoniere. Diffusore in vetro bianco con finitura lucida / Metal fitting with chrome finish for table and suspension lamps. White painted metal fitting for wall, ceiling and lamps. White glass diffuser with gloss finish.

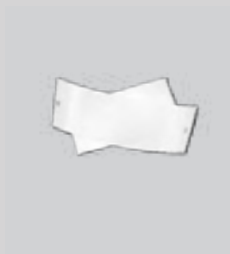
**PENELOPE A/P**

Socket: **2xE14**
 Power: **max 2x28W**
 Input: **220/240V**
 Pack: **0,013 m³**

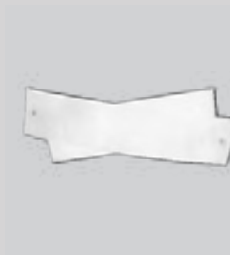
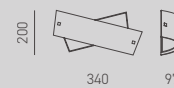
**PENELOPE A/M**

Socket: **4xE14**
 Power: **max 4x28W**
 Input: **220/240V**
 Pack: **0,025 m³**

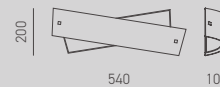
**PENELOPE L**

Socket: **1xE14**
 Power: **max 42W**
 Input: **220/240V**
 Pack: **0,013 m³**

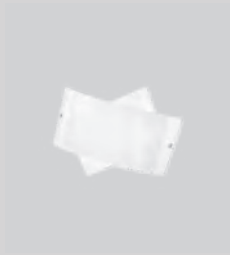
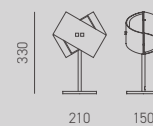
**PENELOPE P/P**

Socket: **3xE14**
 Power: **max 3x28W**
 Input: **220/240V**
 Pack: **0,022 m³**

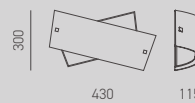
**PENELOPE P/M**

Socket: **2xE27**
 Power: **max 2x70W**
 Input: **220/240V**
 Pack: **0,046 m³**

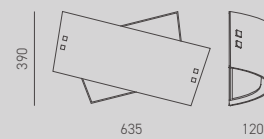

GLASSES

 Bianco / White



PENELOPE S/M

Socket: **2xE27**
 Power: **max 2x52W**
 Input: **220/240V**
 Pack: **0,032 m³**

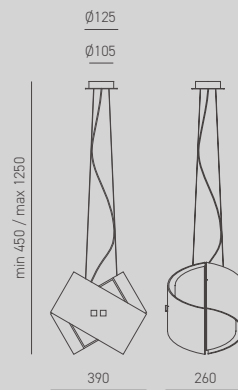

PENELOPE S/G

Socket: **2xE27**
 Power: **max 2x70W**
 Input: **220/240V**
 Pack: **0,058 m³**

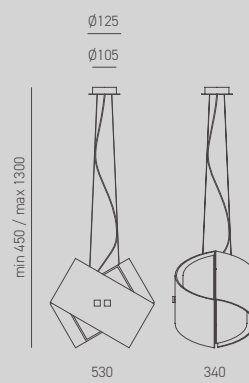



CAMILLA

In Camilla, la libertà di formato si sposa con la ricercatezza delle fasce dominanti, decorate con foglia oro e argento.

The free shape of camilla perfectly accompanies refined predominant bands, decorated with gold and silver leaf.









TECHNICAL INFORMATION

Montatura in metallo con finitura cromo per lumetto e sospensioni.
 Montatura in metallo bianco per applique e plafoniere. Diffusore con vetri colorati foglia oro o foglia argento.
 Finitura lucida /
 Metal fitting with chrome finish for table and suspension lamps.
 White painted metal fitting for wall and ceiling. Diffuser with colour glass, gold or silver leaf. Gloss finish.

**CAMILLA A/P**

Socket: **2xE14**
 Power: **max 2x28W**
 Input: **220/240V**
 Pack: **0,013 m³**

**CAMILLA A/M**

Socket: **4xE14**
 Power: **max 4x28W**
 Input: **220/240V**
 Pack: **0,025 m³**

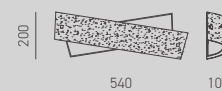
**CAMILLA L/P**

Socket: **1xE14**
 Power: **max 42W**
 Input: **220/240V**
 Pack: **0,013 m³**

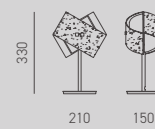
**CAMILLA P/P**

Socket: **3xE14**
 Power: **max 3x28W**
 Input: **220/240V**
 Pack: **0,022 m³**

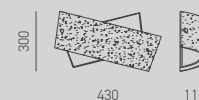
**CAMILLA P/M**

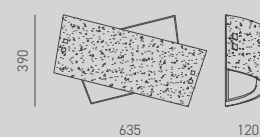

Socket: **2xE27**
 Power: **max 2x70W**
 Input: **220/240V**
 Pack: **0,046 m³**

**CAMILLA S/G**

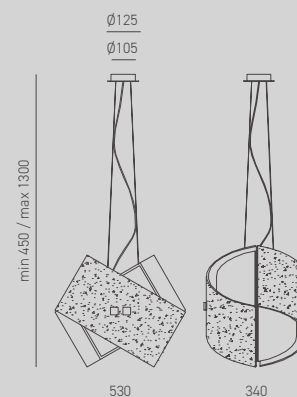
Socket: **2xE27**
 Power: **max 2x70W**
 Input: **220/240V**
 Pack: **0,058 m³**



FINISHING

-  Foglia Oro / Gold Leaf
-  Foglia Argento / Silver Leaf

AGNESE

Le decorazioni tribal con dettagli bianchi regalano un contrasto ottimale con gli spazi più raffinati. Il lume da tavolo è ideale per la zona tv o l'area notte.

Tribal decorations with white details provide an excellent contrast with more refined spaces. The ideal table lamp for the tv area or night area.

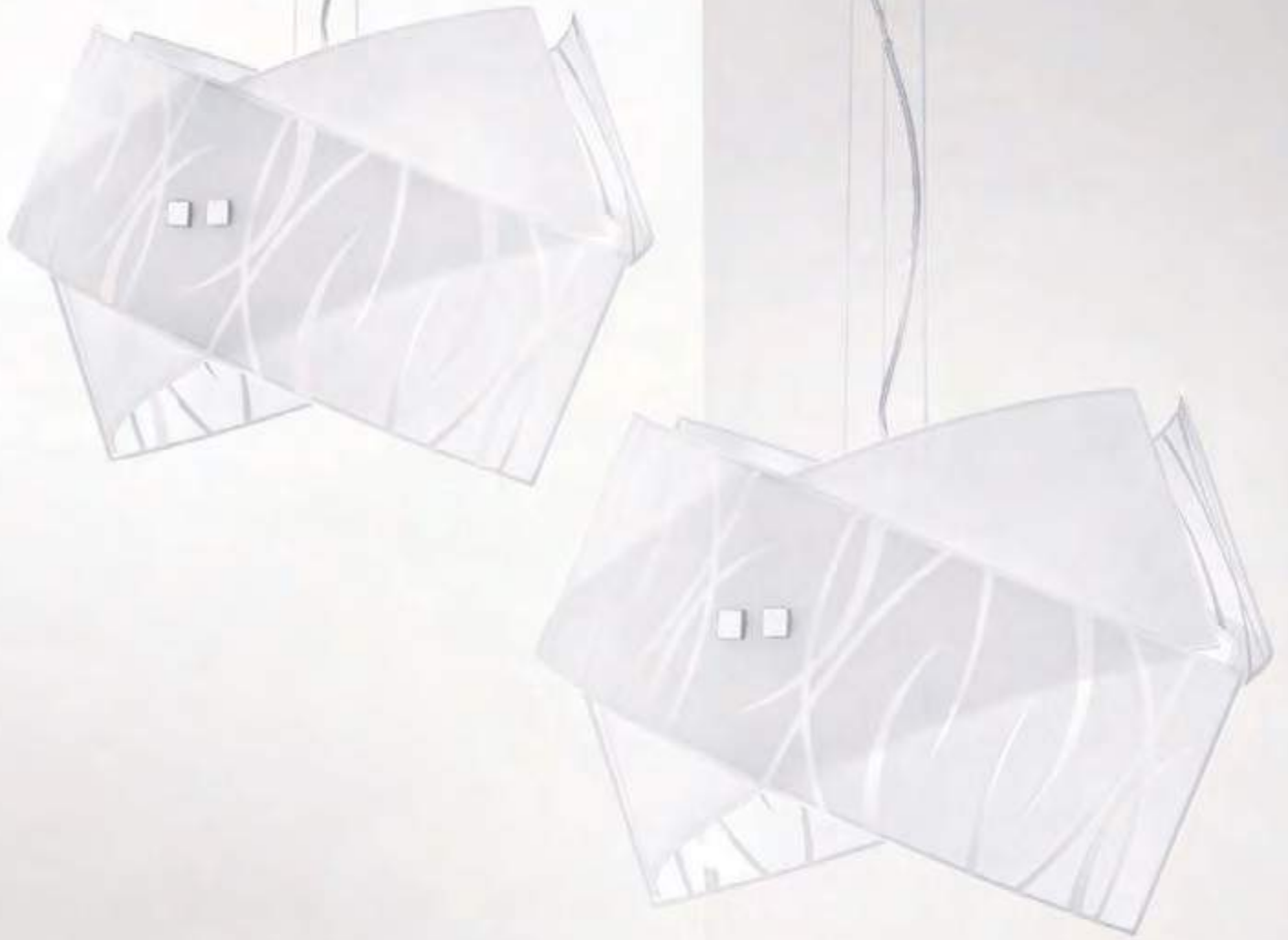









TECHNICAL INFORMATION

Montatura in metallo con finitura cromo per lumetto e sospensioni.
 Montatura in metallo bianco per applique e plafoniere. Diffusore con vetro serigrafato e decorato bianco.
 Finitura satinata /
 Metal fitting with chrome finish for table and suspension lamps.
 White painted metal fitting for wall, ceiling and lamps. Diffuser with white silk screen printed and decorated glass
 Satin finish.

**AGNESE A/P**

Socket: **2xE14**
 Power: **max 2x28W**
 Input: **220/240V**
 Pack: **0,013 m³**

**AGNESE A/M**

Socket: **4xE14**
 Power: **max 4x28W**
 Input: **220/240V**
 Pack: **0,025 m³**

**AGNESE L/P**

Socket: **1xE14**
 Power: **max 42W**
 Input: **220/240V**
 Pack: **0,013 m³**

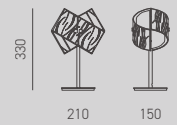
**AGNESE P/P**

Socket: **3xE14**
 Power: **max 3x28W**
 Input: **220/240V**
 Pack: **0,022 m³**

**AGNESE P/M**

Socket: **2xE27**
 Power: **max 2x70W**
 Input: **220/240V**
 Pack: **0,046 m³**

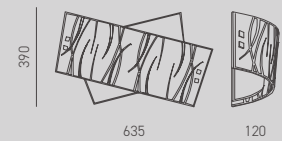

GLASSES

 Bianco / White

**AGNESE S/M**

Socket: **2xE27**
Power: **max 2x52W**
Input: **220/240V**
Pack: **0,032 m³**

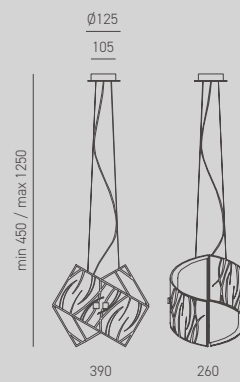
**AGNESE S/G**

Socket: **2xE27**
Power: **max 2x70W**
Input: **220/240V**
Pack: **0,058 m³**

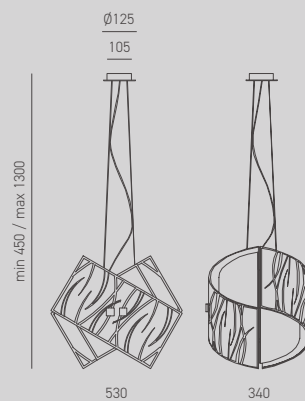



NEREIDE

Il dolce intreccio di decori ornamentali compone l'amalgama ideale di questa eterea collezione composta da sospensione, plafoniera e applique. Unicità e forme convenzionali si intrecciano formando un'impeccabile equilibrio.

The sweet intertwining of ornamental decorations makes up the ideal blend of this ethereal collection consisting of pendant, ceiling and wall lamps. Uniqueness and conventional forms intertwine, forming an impeccable balance.









TECHNICAL INFORMATION

Montatura in metallo, particolari cromo.
 Diffusore in vetro serigrafato bianco.
 Finitura satinata./
 Chrome metal fitting. Etched satined
 white glass.
 Matt finish.

**NEREIDE A**

Socket: **2xE14**
 Power: **max 2x28W**
 Input: **220/240V**
 Pack: **0,01 m³**

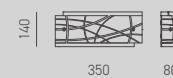
**NEREIDE P/P**

Socket: **2xE27**
 Power: **max 2x42W**
 Input: **220/240V**
 Pack: **0,018 m³**

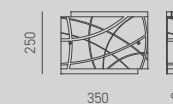
**NEREIDE P/M**

Socket: **2xE27**
 Power: **max 2x52W**
 Input: **220/240V**
 Pack: **0,026 m³**

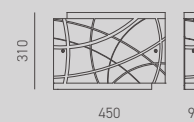
**NEREIDE S/M**

Socket: **2xE27**
 Power: **max 2x52W**
 Input: **220/240V**
 Pack: **0,046 m³**

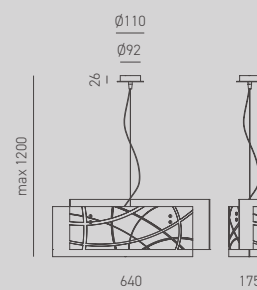
**NEREIDE L**

Socket: **1xE14**
 Power: **max 42W**
 Input: **220/240V**
 Pack: **0,018 m³**

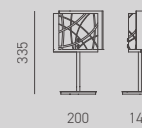

GLASSES



Bianco / White

INDICE INFORMAZIONI TECNICHE

ADELA		AMINA		CAMILLA		EMILY	
ADELA A	363	AMINA S/G	245	CAMILLA A/M	403	EMILY P	179
ADELA PT	363	AMINA S/M	245	CAMILLA A/P	403	EMILY S	179
AFRODITE		AMINA S/P	245	CAMILLA L/P	403	ESTER	
AFRODITE P/M	157	AMINA S/R	245	CAMILLA P/M	403	ESTER S	217
AFRODITE P/P	157	AMINA S/T	245	CAMILLA P/P	403	EVELINE	
AGNESE		ANTEA		CAMILLA S/G	403	EVELINE P/G	137
AGNESE A/M	410	ANTEA P/1	251	CINZIA		FABIANA	
AGNESE A/P	410	ANTEA P/3	251	CINZIA S	145	FABIANA S/G	213
AGNESE L/P	410	ANTEA S/1	251	CLEOFE		FABIANA S/P	213
AGNESE P/M	410	ANTEA S/3	251	CLEOFE S/10	208	FILLY	
AGNESE P/P	410	ARIA		CLEOFE S/11	208	GSOB01	167
AGNESE S/G	411	ARIA A	315	CLEOFE S/12	208	GSOB02	167
AGNESE S/M	411	ARIA P/G	315	CLEOFE S/3	209	GSOB03	167
AIDA		ARIA P/M	315	CLEOFE S/6	209	GSOB04	167
AIDA P/G	351	ARIA P/P	315	DAFNE		GSOB05	167
AIDA P/P	351	BARBIE		DAFNE S/3P	35	GSOB06	167
AIDA S/G	351	BARBIE S/G	235	DAFNE S/G	35	GSOB10	167
AIDA S/P	351	BARBIE S/P	235	DAFNE S/P	35	GSOB11	167
ALICE		BERTA		DAFNE SP/I	35	GSOB12	167
ALICE B R/3	199	BERTA P/G	129	DIVA		GSOB13	167
ALICE B T/3	199	BERTA P/P	129	DIVA L	91	GSOB14	167
ALICE B T/6	199	BERTA PT	129	DIVA P/P	91	GSOB15	167
ALICE M S/G	189	BILBAO		DIVA S/G	91	GSOB20	166
ALICE M S/P	189	BILBAO P/G	309	DIVA S/P	91	GSOB21	166
ALICE M SR/P	199	BILBAO P/M	309	DIVA S/S	91	GSOB22	166
ALICE V/G	189	BILBAO P/P	309	DOHA		GSOB23	166
ALICE V/P	189	BLANCA		DOHA A/G	327	GSOB24	166
ALICE V/P	198	BLANCA S/P	231	DOHA A/P	327	GSOB25	166
ALICE COMPOSIZIONI		BONELLA		DOHA P/G	327	GSOB30	167
GSOBL01	199	BONELLA S/P	227	DOHA P/M	327	GSOB31	167
GSOBL02	199	BRUNA		DOHA P/P	327	GSOB32	167
GSOBL03	199	BRUNA S/G	239	DUNA		GSOB33	167
GSOBL10	199	BRUNA S/P	239	DUNA P	183	GSOB34	167
GSOBL11	199	EDITH S		ELBA		GSOB35	167
GSOBL12	199	EDITH S	171	ELBA S	217	GSOB40	166
						GSOB41	166
						GSOB42	166

GSOB43	166				
GSOB44	166				
GSOB45	166				
GSOB50	167				
GSOB51	167				
GSOB52	167				
GSOB53	167				
GSOB54	167				
GSOB55	167				
GSOBL01	167				
GSOBL02	167				
GSOBL03	167				
GSOBL04	167				
GSOBL05	167				
GSOBL06	167				
GSOBL10	167				
GSOBL11	167				
GSOBL12	167				
GSOBL13	167				
GSOBL14	167				
GSOBL15	167				
GSOS01	166				
GSOS02	166				
GSOS03	166				
GSOS04	166				
GSOS05	166				
GSOS06	166				
FIRENZE					
FIRENZE BI	24				
FIRENZE BI AO	24				
FIRENZE BI AV	24				
FIRENZE BI ST	24				
FIRENZE BI TA	24				
FRIDA					
FRIDA A/G	381				
FRIDA A/P	381				
FRIDA P/G	381				
FRIDA P/M	381				
FRIDA P/P	381				
		FLASH, FLIP, FLUTE			
		GS0070	51		
		GS0071	51		
		GS0072	51		
		GS0073	51		
		GS0074	51		
		GS0075	51		
		GS0080	51		
		GS0081	51		
		GS0082	51		
		GS0083	51		
		GS0084	51		
		GS0085	51		
		GS0090	51		
		GS0091	51		
		GS0092	51		
		GS0093	51		
		GS0094	51		
		GS0095	51		
		FLASH, FLIP, FLUTE COMPOSIZIONI			
		GSOP70	66		
		GSOP71	66		
		GSOP72	66		
		GSOP73	66		
		GSOP74	66		
		GSOP75	66		
		GSOP80	66		
		GSOP81	66		
		GSOP82	66		
		GSOP83	66		
		GSOP84	66		
		GSOP85	66		
		GSOP90	66		
		GSOP91	66		
		GSOP92	66		
		GSOP93	66		
		GSOP94	66		
		GSOP95	66		
		GSOB01	67		
		GSOB02	67		
		GSOB03	67		
		GSOB04	67		
		GSOB05	67		
		GSOB06	67		
		GSOB10	67		
		GSOB11	67		
		GSOB12	67		
		GSOB13	67		
		GSOB14	67		
		GSOB15	67		
		GSOB20	66		
		GSOB21	66		
		GSOB22	66		
		GSOB23	66		
		GSOB24	66		
		GSOB25	66		
		GSOB30	67		
		GSOB31	67		
		GSOB32	67		
		GSOB33	67		
		GSOB34	67		
		GSOB35	67		
		GSOB40	66		
		GSOB41	66		
		GSOB42	66		
		GSOB43	66		
		GSOB44	66		
		GSOB45	66		
		GSOB50	67		
		GSOB51	67		
		GSOB52	67		
		GSOB53	67		
		GSOB54	67		
		GSOB55	67		
		GSOBL01	67		
		GSOBL02	67		
		GSOBL03	67		
		GSOBL04	67		
		GSOBL05	67		
		GSOBL06	67		
		GSOBL10	67		
		GSOBL11	67		
		GSOBL12	67		
		GSOBL13	67		
		GSOBL14	67		
		GSOBL15	67		
		GSOCB2	69		
		GSOCB5	69		
		GSOCG2	69		
		GSOCG5	69		
		GSOCM2	69		
		GSOCM5	69		
		GSOCN2	69		
		GSOCN5	69		
		GSOCO2	69		
		GSOCO5	69		
		GSOCR2	69		
		GSOCR5	69		
		GSOCS2	69		
		GSOCS5	69		
		GSOCV2	69		
		GSOCV5	69		
		GSOCW2	69		
		GSOCW5	69		
		GAETA			
		GAETA BI		25	
		GAETA BI AO		25	
		GAETA BI AV		25	
		GAETA BI ST		25	
		GAETA BI TA		25	
		GAETA CO D		26	
		GAETA CO S		26	
		GAETA COV		24	
		GAETA COV		25	
		GAETA TR		26	
		GENOVA			
		GENOVA SP		22	

INDICE INFORMAZIONI TECNICHE

GISELLE		ISOTTA		LAMPADINE DECORATIVE		LUNA	
GISELLE P/G	301	ISOTTA P/G	295	GLA400	76	LUNA P/G	289
GISELLE P/M	301	ISOTTA P/M	295	GLA401	76	LUNA P/M	289
GISELLE P/P	301	ISOTTA P/P	295	GLA410	76	LUNA P/P	289
GISELLE S	301	ISOTTA S	295	GLA411	76	LUNA S	289
GORIZIA		JADE		GLA420	77	MAGIS	
GORIZIA RE/G	22	JADE S	175	GLA421	77	GAP440C	267
GORIZIA RE/M	22	JESI		GLA430	77	GAP440N	267
GORIZIA RE/P	22	JESI SP	23	GLA431	77	GAP441C	267
GRACE		KATRINE		GLA440	78	GAP441N	267
GRACE P/G	331	KATRINE P/M	133	GLA441	78	GAP442C	267
GRACE P/M	331	KATRINE P/P	133	GLA450	78	GAP442N	267
GRACE P/P	331	KRIZIA		GLA451	78	GAP443C	267
GUYA		KRIZIA P/G	119	GLA460	79	GAP443N	267
GUYA S/1	47	KRIZIA P/M	119	GLA461	79	GAP450C	268
GUYA S/3	47	KRIZIA P/P	119	GLA470	79	GAP450N	268
GUYA S/I	47	KRIZIA P/S	119	GLA471	79	GAP451C	268
HELENA		KRIZIA S/2	118	GLA472	79	GAP451N	268
HELENA S/1	39	KRIZIA S/G	118	LARA		GAP452C	268
HELENA S/3	39	KRIZIA S/M	118	LARA A/P	387	GAP452N	268
IOLE		KRIZIA S/P	118	LARA P/G	387	GAP453C	268
IOLE L	107	LECCE		LARA P/M	387	GAP453N	268
IOLE PT	107	LECCE A/G	375	LARA P/P	387	GAP460C	269
IOLE S/1	106	LECCE A/P	375	LIVORNO		GAP460N	269
IOLE S/2	106	LECCE P/M	375	LIVORNO S	23	GAP461C	269
IOLE S/3	106	LECCE P/P	375	LORETO S		GAP461N	269
IRENE		LIVORNO		LORETO S	23	GAP462C	269
IRENE P/G	283	LIVORNO S	23	MANILA		GAP462N	269
IRENE P/M	283	LORETO S		MANILA P/G	273	GAP463C	269
IRENE P/P	283	LORETO S	23	MANILA P/M	273	GAP463N	269
IRENE S	283			MANILA P/P	273		

MELANIA

MELANIA P/G 3000°K	141
MELANIA P/G 4000°K	141
MELANIA P/M 3000°K	141
MELANIA P/M 4000°K	141
MELANIA P/P 3000°K	141
MELANIA P/P 4000°K	141

MICHELA

MICHELA A/G	371
MICHELA A/P	371
MICHELA P/M	371
MICHELA P/P	371

MODENA

MODENA SP/G	23
MODENA SP/P	22

NARDO'

NARDO' S	23
NARDO' SP	22

NEKKAR

GLS020	333
GLS021	333
GLS022	333
GLS023	333

NEREIDE

NEREIDE A	417
NEREIDE L	417
NEREIDE P/M	417
NEREIDE P/P	417
NEREIDE S/M	417

NICOLE

NICOLE L	111
----------	-----

NUNKI

GLS001	335
GLS002	335
GLS003	335
GLS004	335
GLS005	335

OLIMPIA

OLIMPIA P/G	305
OLIMPIA P/M	305
OLIMPIA P/P	305

ONE

GAP490C	263
GAP491C	263
GAP492C	263
GAP493C	263

PENELOPE

PENELOPE A/M	396
PENELOPE A/P	396
PENELOPE L	396
PENELOPE P/M	396
PENELOPE P/P	396
PENELOPE S/G	397
PENELOPE S/M	397

PING-PONG

GPIB01	339
GPIN01	339

POINT

GSOP01	73
GSOP02	73
GSOP03	73
GSOP04	73
GSOP05	73
GSOP06	73

POLAR

GAP480C	259
GAP481C	259
GAP482C	259
GAP483C	259

RING

GAP470C	255
GAP470N	255

SFERA

SFERA S	223
SFERA S/10	223
SFERA S/6	223

SOLE

SOLE P/G	277
SOLE P/M	277
SOLE P/P	277
SOLE S	277

SUELO

SUELO PT	359
----------	-----

TARA

TARA L	355
TARA PT	355

TESSA

TESSA P/3 3000°K	153
TESSA P/3 4000°K	153
TESSA P/5 3000°K	153
TESSA P/5 4000°K	153

TOSCA

TOSCA P/1 3000°K	149
TOSCA P/1 4000°K	149
TOSCA P/3 3000°K	149
TOSCA P/3 4000°K	149
TOSCA P/4 3000°K	149
TOSCA P/4 4000°K	149

TULLIA

TULLIA P/3 3000°K	161
TULLIA P/3 4000°K	161
TULLIA P/4 3000°K	161
TULLIA P/4 4000°K	161

VELIA

VELIA A	367
VELIA L	367
VELIA PT	367

YARA

YARA P/G C	125
YARA P/G N	125
YARA P/M C	125
YARA P/M N	125
YARA P/P C	125
YARA P/P N	125
YARA S/G C	125
YARA S/G N	125
YARA S/P C	125
YARA S/P N	125

YPSILON

GPIB10	343
GPIN10	343

ZAIRA

ZAIRA L	347
ZAIRA PT	347

General Sales Conditions /

CONDIZIONI GENERALI DI VENDITA

CONDIZIONI GENERALI DI VENDITA

Le descrizioni e le illustrazioni dei prodotti devono intendersi a titolo indicativo. È vietata la riproduzione, la copia anche parziale e la diffusione di questo documento attraverso qualsiasi mezzo (telematico, fotocopia o altro) senza permesso scritto del proprietario. Pertanto la GEA LUCE si riserva il diritto di fare tutte le modifiche per migliorare il prodotto senza obbligo di preavviso. Non verranno accettati ritorni di merce se non preavvisati e da noi espressamente autorizzati. Porto Franco euro 150,00 (netti). Saranno addebitati euro 10,00 come contributo per spese di trasporto e imballo per ordini inferiori a euro 150,00 (netti). Non verrà addebitato nessun costo aggiuntivo per il contributo RAEE sostenuto dall'azienda. Per ogni controversia è competente il Foro di Foggia.

GENERAL SALES CONDITIONS

Strict accuracy of descriptions and illustrations of the products cannot be guaranteed. No part of this document may be reproduced or transmitted in any form, by any means (electronic, photocopying, recording or otherwise) without the prior written permission of the owner. There fore due to its policy of product improvement, GEALUCE reserves the right to make any changes without notice. No goods may be returned without previous GEA LUCE's written permission. All goods supplied ex factory. The RAEE costs will be hold from our company. All legal actions to take place under the jurisdiction of the Foggia Authorities.



GEA LUCE s.r.l.
Via Teodoro Tardio
71016 San Severo (FG)

T +39 0882 37.49.54
F +39 0882 33.61.61

www.gealuce.com
info@gealuce.com



Art Direction
Mario Cappelletto

Photo / Photo editing
AsolanaGroup
Archivio Gea Luce
Quasar

Courtesy artistic work (p. 265)
Sandi Renko

Print
Asolana Group

Printed in Italy
June 2021

© GEA LUCE Srl

