

4202430 - LOU LOU

S Montera lampan enligt skissen.

Om anslutningskabeln skadas skall den bytas ut av tillverkaren, eller dennes representant, eller annan person som har erforderlig kännedom, för att undvika fara.

N Monter lampan i henhold til skissen.

SF Kiinnitä lamppu alla olevan piirroksen mukaan.

EN Assembly the lamp according to the sketch.

If the external cable or cord of this luminaire is damaged, it must be replaced by the manufacturer or his agent, or other person who has the required knowledge, in order to avoid a hazard.

D Montieren Sie die Leuchte laut Skizze.

F Montez la lampe conformément au croquis.

I Montare la luce del diagramma.

PL Zamontuj lampę zgodnie ze szkicem.

ES Siga las instrucciones de montaje e instalación según el plano.

1 x E27 Max 8W LED

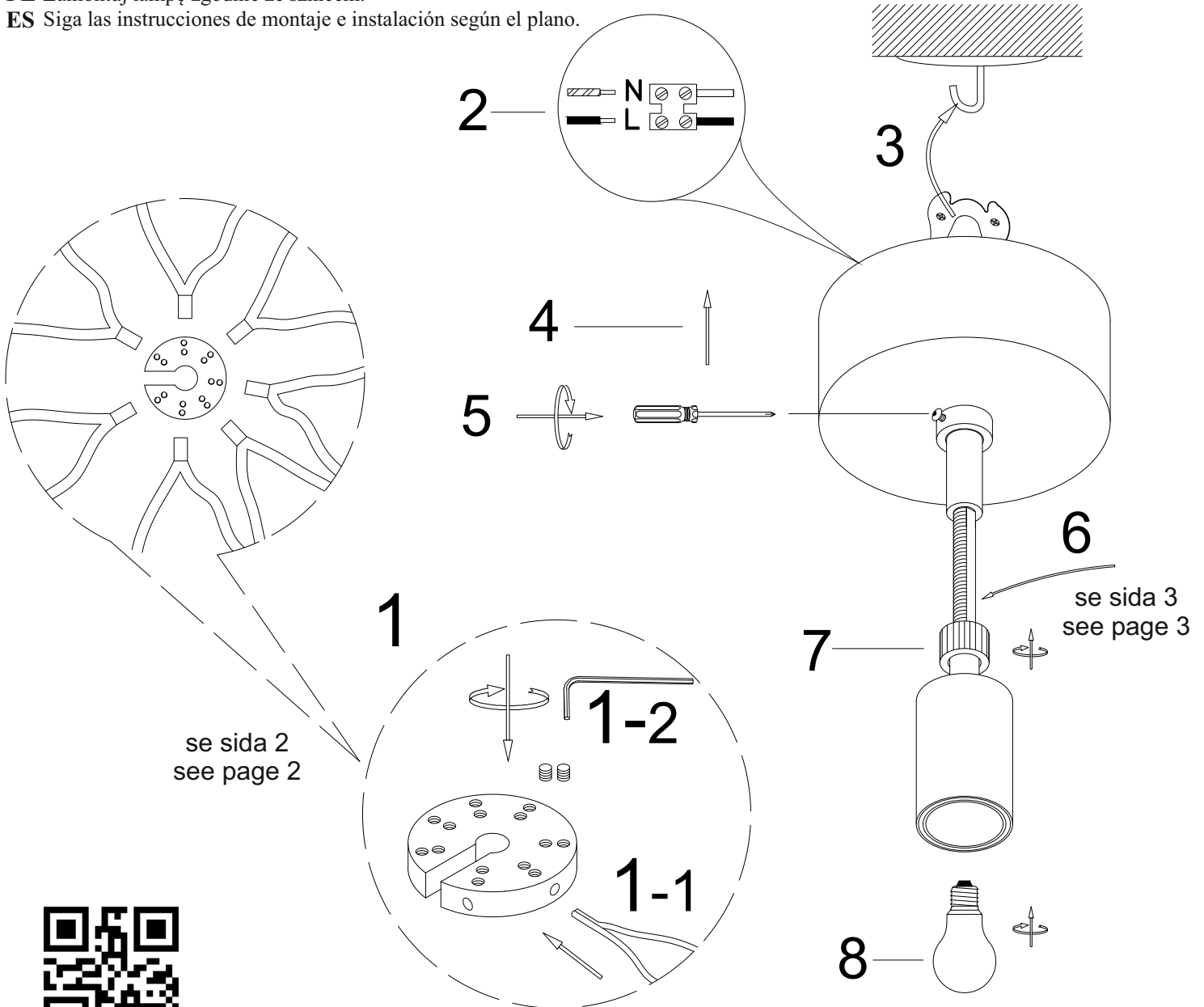
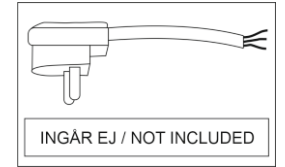
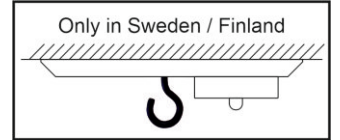

byrydens.com

1:a lagret 5 blad 15x29cm
1th layer 5 pcs 15x29cm

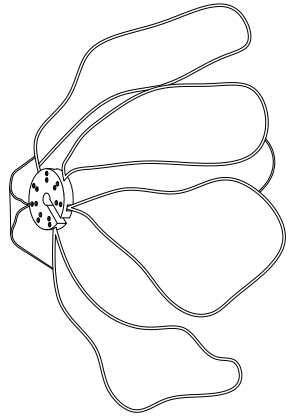

2:a lagret 5 blad 23x39cm
2th layer 5 pcs 23x39cm

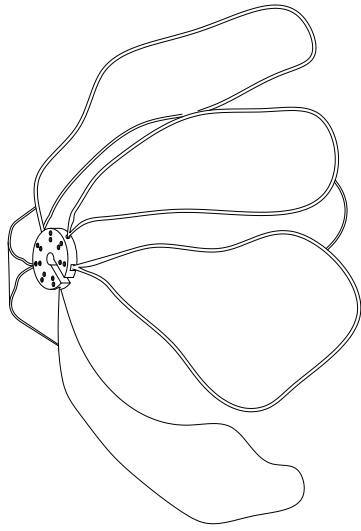

3:e lagret 6 blad 23x46cm
3th layer 6 pcs 23x46cm

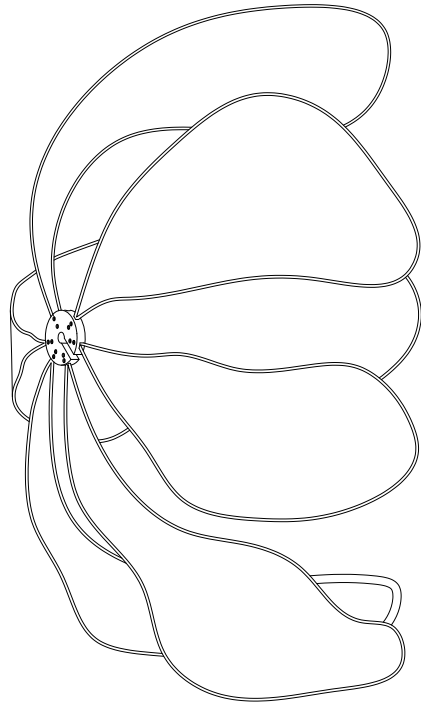

4:e lagret 6 blad 24x53cm
4th layer 6 pcs 24x53cm

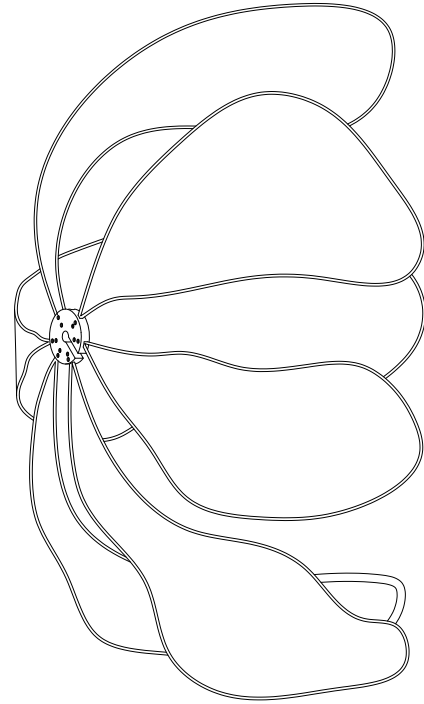

5:e lagret 7 blad 28x55cm
5th layer 7 pcs 28x55cm

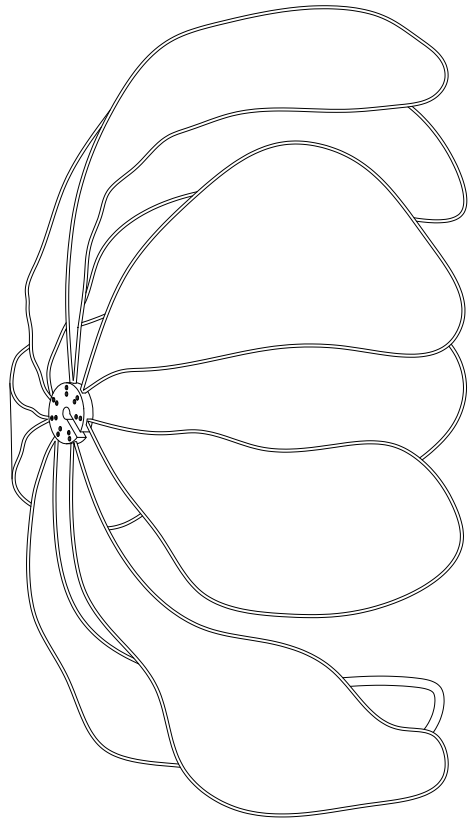

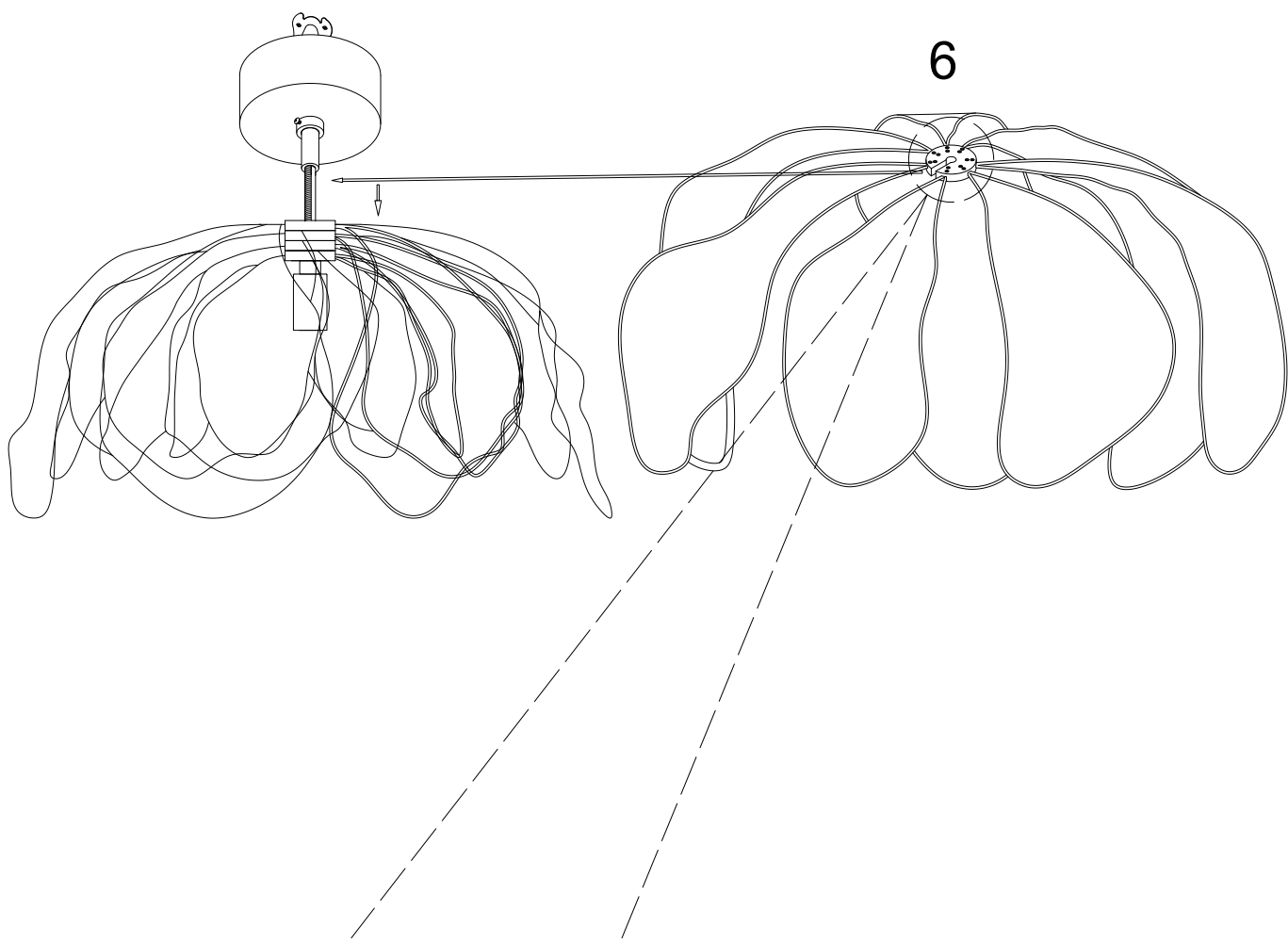

6-1

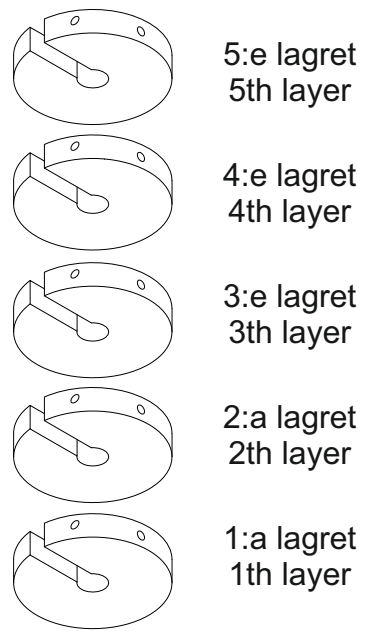

6-2

